



2022



58700

216 pieces VOREL tool set in a handy case.
Designed for assembly, workshop and household works.

- tools made of CrV 6140, CrV 50BV30 and carbon steel
- As-drive system increases the maximum torque by 25% and protects the screw against damage
- wide range sizes of spanners, sockets and bits

Zestaw 216 narzędzi VOREL w poręcznej walizce.

Przeznaczony do prac montażowych, warsztatowych i w gospodarstwie domowym.

- narzędzia wykonane ze stali węglowej, CrV 6140 i CrV 50BV30
- system As-drive zwiększa maksymalny moment o 25% i zabezpiecza śrubę przed uszkodzeniem
- szeroki przekrój rozmiarów kluczy, nasadek i bitów



www.toya.pl

**AS-DRIVE
SYSTEM**

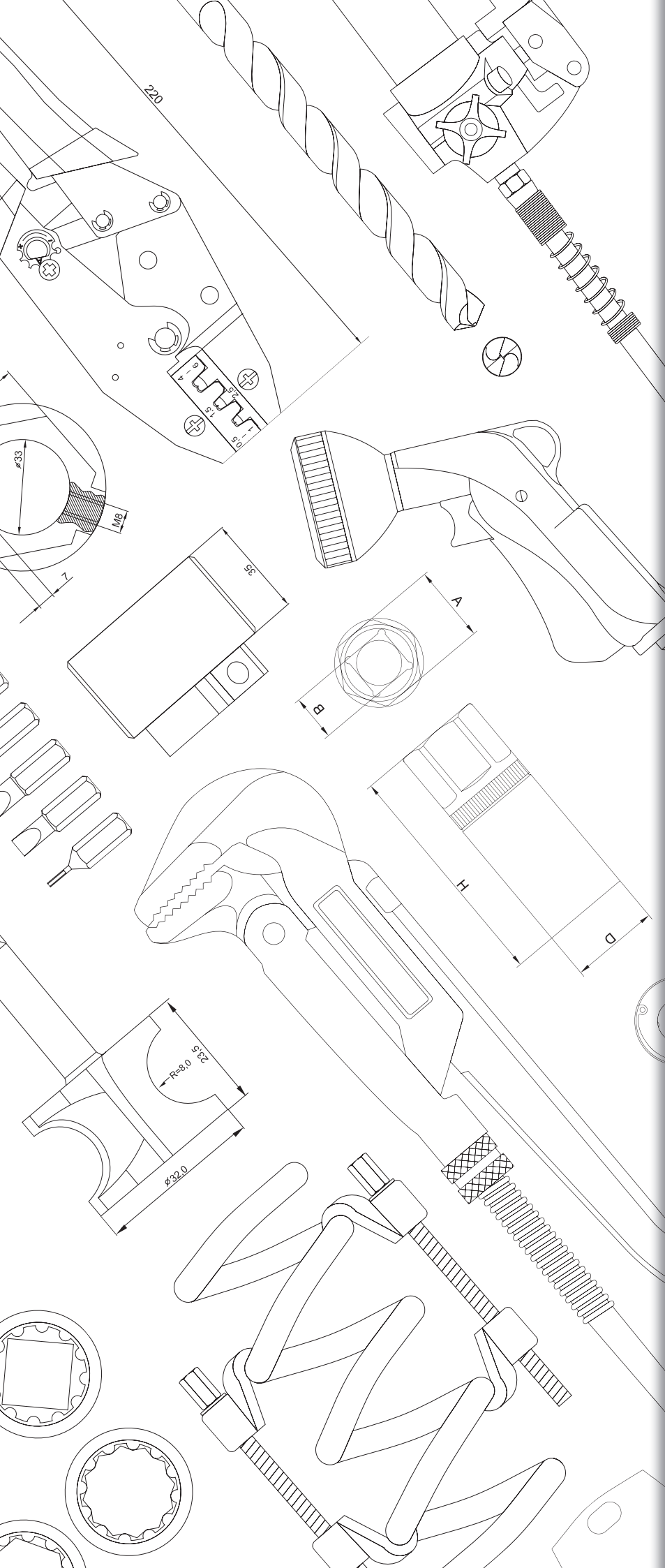

TOYA SA
ul. Sołtysowicka 13-15
51-168 Wrocław
☎ (+48 71) 32 46 200
fax: (+48 71) 32 46 370

sales@yato.pl (sale)
export@yato.pl (export)
import@yato.pl (import)

ODDZIAŁ WARSZAWSKI
Teren ProLogis Park Nadarzyn
al. Kasztanowa 160
05-831 Młochów k. Warszawy

☎ (+48 22) 73 82 800
☎ (+48 22) 73 82 828
sales@yato.pl (sale)
export@yato.pl (export)

1 Spanners Klucze

6-13



2 Sockets, accessories & sets Klucze nasadowe, akcesoria i zestawy

14-23



3 Screwdrivers & screwdriver bits Wkrętaki i końcówki wkrętakowe

24-43



4 Pliers & pipe wrenches Szczypce i klucze do rur

44-53



5 Electrician tools Narzędzia dla elektryków

54-59



6 Hammers, chisels, punches & axes Młotki, dłuta, przecinaki i siekiery

60-71



7 Clamps & vices Ściski i imadła

72-77



8 Cutting tools Narzędzia tnące

78-121



9 Plumbing tools Narzędzia hydrauliczne

122-129



10 Fastening tools Narzędzia do łączenia

130-147

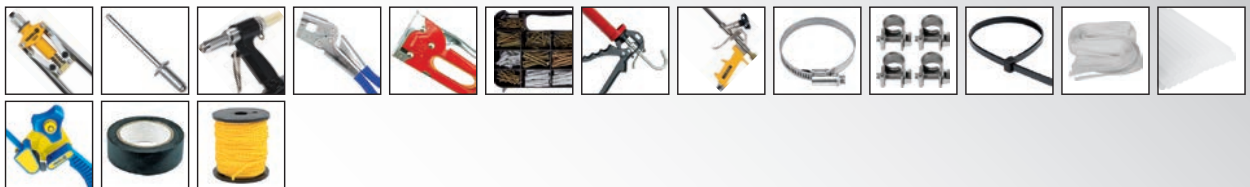

11 Plastering & bricklaying tools Narzędzia budowlane i malarskie

148-187



12 Measuring tools Narzędzia miernicze

188-205



13 Pneumatic tools Narzędzia pneumatyczne

206-217



14 Special automotive tools & equipment Narzędzia i wyposażenie warsztatu samochodowego

218-255



15 Power tools & accessories 256-285
Elektronarzędzia i akcesoria



16 Welding equipment 286-293
Sprzęt spawalniczy



17 Safes, padlocks & locks 294-303
Sejfy, kłódki i zamki



18 Accessories 304-309
Akcesoria



19 Bicycle accessories 310-315
Akcesoria rowerowe



20 Kitchen and home appliance 316-345
Sprzęt AGD



21 Household equipment 346-375
Gospodarstwo domowe



22 Health & safety products Artykuły BHP

376-391



23 Electric products Artykuły elektryczne

392-405



24 Garden tools & power tools Narzędzia i elektronarzędzia ogrodowe

406-481



25 Sanitary ware & hydraulics Armatura sanitarna i hydraulika

482-527



Memo

1

Spanners Klucze



Combination spanners Klucze płasko-oczkowe

8-10



Combination spanners & sets, polished head
Klucze płasko-oczkowe i zestawy,
polerowana główka..... 8

Combination spanners & sets, satin finish CrV
Klucze płasko-oczkowe i zestawy,
wykończenie satynowe CrV..... 9

Combination ratchet wrenches Klucze płasko-oczkowe z grzechotką

10



Combination ratchet wrenches
Klucze płasko-oczkowe z grzechotką..... 10

Combination ratchet wrench sets
Zestawy kluczy płasko-oczkowych z grzechotką..... 10

Double open end spanners Klucze płaskie

10-11



Double open end spanners & sets, polished head
Klucze płaskie i zestawy, polerowana główka..... 10

Double open end spanner sets, satin finish CrV
Zestawy kluczy płaskich,
wykończenie satynowe CrV..... 11

Bi-hexagonal ring spanners Klucze oczkowe odgięte

11



Bi-hexagonal ring spanner sets, polished head
Zestawy kluczy oczkowych odgiętych, polerowana główka..... 11

Open end swivel socket spanners Klucze płasko-nasadowe

11



T-type deep socket wrenches Klucze nasadowe typu „T”

11

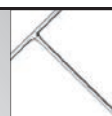

Box end wrenches Klucze rurowe

11



L-type wrenches Klucze nasadowe typu „L”

12



Multipipe wrenches Klucze uniwersalne

12



Double ratchet wrenches Klucze nasadkowe z grzechotką

12



Adjustable wrenches Klucze nastawne

12-13



Torque wrenches Klucze dynamometryczne

13



1

EN Combination spanner
 PL Klucz płasko-oczkowy
 DE Maulringschlüssel
 RU Ключ комбинированный

CS Plochý a očkový klíč
 RO Cheie combinata
 HU Kulcs villás-csillag
 ES Combinada con llave de estrella



No.	Size / Rozmiar [mm]	
51060	6	200/1200
51070	7	200/1000
51080	8	60/600
51090	9	60/600
51100	10	50/600
51110	11	50/400
51120	12	50/400
51130	13	50/400
51140	14	50/300
51150	15	50/300
51160	16	50/200
51170	17	20/200
51180	18	25/200
51190	19	30/120
51200	20	20/160
51210	21	20/120
51220	22	30/120
51240	24	15/90
51270	27	15/60
51300	30	10/40
51320	32	10/40

EN Combination spanner set
 PL Komplet kluczy płasko-oczkowych
 DE Maulringschlüsselsatz
 RU Набор комбинированных ключей
 CS Souprava plochých a očkových klíčů
 RO Set chei combinate
 HU Kulcskészlet villás-csillag clip
 ES Juego de combinadas con llave de estrella



No.	Size / Rozmiar [mm]	pcs / szt.	
51580	6, 8, 10, 11, 13, 14, 17, 19	8	5/50
51620	6, 7, 8, 9, 10, 11, 12, 13, 14, 17, 19, 22	12	5/20
51650	6, 7, 8, 9, 10, 11, 12, 13, 14, 15, 16, 17, 18, 19, 20, 21, 22, 23, 24, 25, 26, 27, 28, 30, 32	25	1/4

EN Combination spanner
 PL Klucz płasko-oczkowy
 DE Maulringschlüssel
 RU Ключ комбинированный
 CS Plochý a očkový klíč
 RO Cheie combinata
 HU Kulcs villás-csillag
 ES Combinada con llave de estrella



STHOR

No.	Size / Rozmiar [mm]	
51040	6	200/1200
51042	8	100/600
51044	10	50/600
51046	12	50/400
51047	13	50/400
51048	14	50/300
51049	15	50/300
51051	17	20/200

EN Combination spanner set
 PL Komplet kluczy płasko-oczkowych
 DE Maulringschlüsselsatz
 RU Набор комбинированных ключей
 CS Souprava plochých a očkových klíčů
 RO Set chei combinate
 HU Kulcskészlet villás-csillag clip
 ES Juego de combinadas con llave de estrella



No.	Size / Rozmiar [mm]	pcs / szt.	
51560	8, 10, 12, 13, 14, 17	6	15/60
51590	6, 8, 10, 12, 13, 14, 17, 19	8	10/40
51630	6, 7, 8, 9, 10, 11, 12, 13, 14, 17, 19, 22	12	5/20
51640	6, 7, 8, 9, 10, 11, 12, 13, 14, 17, 19, 21, 24, 27, 32	15	2/12
51645	6, 7, 8, 9, 10, 11, 12, 13, 14, 15, 16, 17, 18, 19, 21, 22, 24, 27, 30, 32	20	2/8

EN Combination spanner set
 PL Komplet kluczy płasko-oczkowych
 DE Maulringschlüsselsatz
 RU Набор ключей комбинированных
 CS Souprava plochých a očkových klíčů
 RO Set chei combinate
 HU Kulcskészlet, villás-csillag
 ES Juego de combinadas con llave de estrella



VOREL

No.	Size / Rozmiar [mm]	pcs / szt.	
50850	8, 10, 12, 13, 14, 17	6	4/40
50861	6, 8, 10, 13, 14, 17, 19, 22	8	4/32
50871	6, 7, 8, 9, 10, 11, 12, 13, 14, 17, 19, 22	12	2/20

EN Combination spanner set
 PL Komplet kluczy plasko-oczkowych
 DE Maulringschlüsselsatz
 RU Набор ключей комбинированных

CS Souprava plochých a očkových klíčů
 RO Set chei combinate rasucite
 HU Kulcskészlet, villás-csillag
 ES Juego de combinadas con llave de estrella

9
PCS

CrV



No.	Size / Rozmiar	pcs / szt.	
50880	1/4" (6.3 mm), 5/16" (7.9 mm), 3/8" (9.5 mm), 7/16" (11.1 mm), 1/2" (12.7 mm), 9/16" (14.3 mm), 5/8" (15.9 mm), 1/16" (17.5 mm), 3/4" (19.0 mm)	9	10

EN Combination spanner set
 PL Komplet kluczy plasko-oczkowych
 DE Maulringschlüsselsatz
 RU Набор комбинированных ключей

CS Souprava plochých a očkových klíčů
 RO Set chei combinate
 HU Kulcskészlet villás-csillag clip
 ES Juego de combinadas con llave de estrella

CrV



No.	Size / Rozmiar [mm]	pcs / szt.	
51720	8, 10, 12, 13, 14, 17	6	4/40
51721	6, 8, 10, 12, 13, 14, 17, 19	8	4/32
51722	6, 7, 8, 9, 10, 11, 12, 13, 14, 17, 19, 22	12	2/20

EN Combination spanner set
 PL Komplet kluczy plasko-oczkowych
 DE Maulringschlüsselsatz
 RU Набор ключей комбинированных

CS Souprava plochých a očkových klíčů
 RO Set chei combinate rasucite
 HU Kulcskészlet, villás-csillag
 ES Juego de combinadas con llave de estrella

8
PCS

CrV



No.	Size / Rozmiar [mm]	pcs / szt.	
51705	8, 10, 12, 13, 14, 15, 17, 19	8	30

EN Combination spanner
 PL Klucz plasko-oczkowy
 DE Maulringschlüssel
 RU Ключ комбинированный
 CS Plochý a očkový klíč
 RO Cheie combinata
 HU Kulcs villás-csillag
 ES Combinada con llave de estrella

CrV



1



No.	Size / Rozmiar [mm]	
51671	6	20/400
51672	7	20/400
51673	8	20/400
51674	9	20/400
51675	10	20/320
51676	11	20/240
51677	12	20/240
51678	13	20/200
51679	14	20/200
51680	15	20/200
51681	16	20/200
51682	17	20/160
51683	18	20/160
51684	19	20/160
51685	20	20/120
51686	21	20/120
51687	22	20/120
51688	23	10/80
51689	24	10/80
51690	25	10/60
51691	26	10/40
51692	27	10/40
51693	28	10/40
51694	29	10/40
51695	30	10/40
51696	32	10/40

EN Combination spanner set
 PL Komplet kluczy plasko-oczkowych
 DE Maulringschlüsselsatz
 RU Набор ключей комбинированных

CS Souprava plochých a očkových klíčů
 RO Set chei combinate rasucite
 HU Kulcskészlet, villás-csillag
 ES Juego de combinadas con llave de estrella

12
PCS

CrV



No.	Size / Rozmiar [mm]	pcs / szt.	
51710	6, 8, 10, 11, 12, 13, 14, 15, 17, 18, 19, 22	12	20

1

- EN Combination spanner set
- PL Komplet kluczy płasko-oczkowych
- DE Maulringschlüsselsatz
- RU Набор ключей комбинированных
- CS Souprava plochých a očkových klíčů
- RO Set chei combinate rasucite
- HU Kulcskészlet, villás-csillag
- ES Juego de combinadas con llave de estrella

25 PCS CrV



No.	Size / Rozmiar [mm]	pcs / szt.	
51715	6, 7, 8, 9, 10, 11, 12, 13, 14, 15, 16, 17, 18, 19, 20, 21, 22, 23, 24, 25, 26, 27, 28, 30, 32	25	4

- EN Combination ratchet wrench set
- PL Zestaw kluczy płasko-oczkowych z grzechotką
- DE Ratschenringmaulschlüssel-Satz
- RU Набор комбинированных ключей с трещоткой
- CS Klíče ráčnové sada
- RO Set chei combinate
- HU Racsnis csillag-villás kulcs készlet
- ES Juego de llaves planas con matraca

4 PCS 72T 60Si2Mn CrV



No.	Size / Rozmiar [mm]	pcs / szt.	
52661	10, 13, 17, 19	4	10/20

- EN Double open end spanner set
- PL Komplet kluczy płaskich
- DE Doppelmaulschlüsselsatz
- RU Набор ключей рожковых
- CS Souprava plochých klíčů
- RO Set chei fixe
- HU Kulcskészlet, villás
- ES Juego de llaves fijas

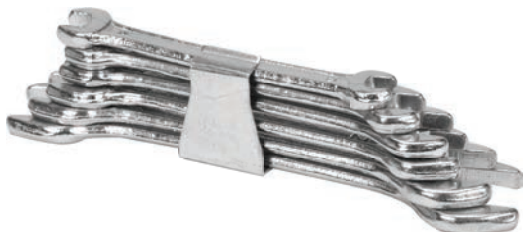

No.	Size / Rozmiar [mm]	pcs / szt.	
50560	6x7, 8x9, 10x11, 12x13, 14x15, 16x17	6	20/80
50590	6x7, 8x9, 10x11, 12x13, 14x15, 16x17, 18x19, 20x22	8	10/40
50610	6x7, 8x9, 10x11, 12x13, 14x15, 16x17, 18x19, 20x22, 24x27, 30x32	10	5/20
50630	6x7, 8x9, 10x11, 12x13, 14x15, 16x17, 18x19, 20x22, 21x23, 24x26, 25x28, 27x32	12	5/15

- EN Combination ratchet wrench
- PL Klucz płasko-oczkowy z grzechotką
- DE Ratschenringmaulschlüssel
- RU Ключ комбинированный с трещоткой
- CS Klíč očkoplochý ráčnový
- RO Cheie combinata cu crichet
- HU Csillag-villás kulcs racsnis
- ES Llave combinada fija abierta y carraca

72T 60Si2Mn CrV



No.	Size / Rozmiar [mm]	
52652	10	10/100
52653	11	10/100
52654	12	10/100
52655	13	10/100
52656	14	10/100
52657	15	10/100
52658	17	10/50
52659	19	10/50
52660	22	10/40

- EN Double open end spanner
- PL Klucz płaski
- DE Doppelmaulschlüssel
- RU Ключ рожковый
- CS Plochý klíč
- RO Cheie fixa
- HU Villáskulcs
- ES Llave fija



No.	Size / Rozmiar [mm]	
50070	6x7	100/1000
50090	8x9	60/600
50100	8x10	60/600
50110	10x11	60/600
50120	10x13	50/500
50130	12x13	50/500
50150	14x15	50/300
50170	13x17	50/300
50190	17x19	30/180
50220	19x22	30/180
50270	24x27	25/100
50330	30x32	15/60

- EN Double open end spanner set
- PL Komplet kluczy płaskich
- DE Doppelmaulschlüsselsatz
- RU Набор ключей рожковых
- CS Souprava plochých klíčů
- RO Set chei fixe
- HU Kulcskészlet, villás
- ES Juego de llaves fijas



No.	Size / Rozmiar [mm]	pcs / szt.	
50580	6x7, 8x9, 10x11, 12x13, 14x15, 16x17, 18x19, 20x22	8	10/40

EN Double open end spanner set
 PL Komplet kluczy płaskich
 DE Doppelmaulschlüsselsatz
 RU Набор ключей рожковых
 CS Souprava plochých klíčů
 RO Set chei fixe
 HU Kulcskészlet, villás
 ES Juego de llaves fijas



VOREL

No.	Size / Rozmiar [mm]	pcs / szt.	
51740	6x7, 8x9, 10x11, 12x13, 14x15, 16x17	6	4/40
51741	6x7, 8x9, 10x11, 12x13, 14x15, 16x17, 18x19, 20x22	8	4/24

EN Bi-hexagonal ring spanner set
 PL Komplet kluczy oczkowych odgiętych
 DE Doppelringschlüsselsatz
 RU Набор ключей накидных изогнутых
 CS Klíče očkové vyhnuté sada
 RO Set chei inelare cu cot
 HU Csillagkulcs készlet
 ES Juego de llaves de estrella acodadas

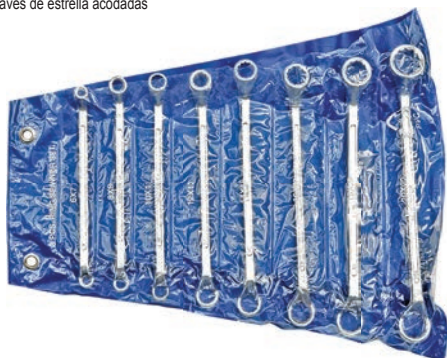

No.	Size / Rozmiar [mm]	pcs / szt.	
52580	6x7, 8x9, 10x11, 12x13, 14x15, 16x17, 18x19, 20x22	8	5/20

EN T-type socket wrench
 PL Klucz nasadowy typu „T”
 DE T-Griff-Steckschlüssel
 RU Ключ торцевой Т-образный
 CS Šerový a nastrčný klíč
 RO Cheie tubulara tip „T”
 HU Kulcs, csap-dugó
 ES Llave mandril vaso



No.	Socket size / Rozmiar nasadki [mm]	L [mm]	
56770	8	190	50
56710	8	380	50
56780	10	190	50
56720	10	380	50
56790	13	190	50
56730	13	380	50

EN Bi-hexagonal ring spanner set
 PL Komplet kluczy oczkowych odgiętych
 DE Doppelringschlüsselsatz
 RU Набор ключей накидных изогнутых



No.	Size / Rozmiar [mm]	pcs / szt.	
52630	6x7, 8x9, 10x11, 12x13, 14x15, 16x17, 18x19, 20x21, 22x23, 24x25, 26x27, 28x32	12	2/8

EN Open end swivel head socket wrench
 PL Klucz płasko-nasadowy, przegubowy
 DE Maul-Steckschlüssel
 RU Ключ рожково-торцевой с шарниром



No.	Size / Rozmiar [mm]	
52680	8	20/200
52700	10	20/200
52730	13	20/200
52740	14	20/200
52750	15	25/100
52770	17	25/100
52790	19	25/50
52820	22	25/50

EN Tubular socket wrench set
 PL Komplet kluczy rurowych
 DE Rohrsteckschlüsselsatz
 RU Набор ключей трубчатых
 CS Klíče trubkové
 RO Chei pt. țevi
 HU Csőkulcs
 ES Llaves de tubería



No.	Size / Rozmiar [mm]	pcs / szt.	
52900	6x7, 8x9, 10x11, 12x13, 14x15, 16x17, 18x19, 20x22	10	6/24



1

10
PCS

1

EN L-type socket wrench
 PL Klucz nasadowy typu „L”
 DE Steckschlüssel gebogen
 RU Ключ торцевой L-типа

CS Nástrčný kľúč fajfkový
 RO Cheie tubulara cu cot tip „L”
 HU Kulcs, dugó-pipa
 ES Llave de vaso „L”



No.	Size / Rozmiar [mm]	
54600	6	80/320
54610	7	80/320
54620	8	50/200
54630	9	40/160
54640	10	40/160
54650	11	25/100
54660	12	25/100
54670	13	25/100
54680	14	20/80
54690	15	20/80
54700	16	12/48
54710	17	12/48
54720	18	10/40
54730	19	10/40
54750	21	6/24
54760	22	10/60
54780	24	10/40

EN Adjustable wrench
 PL Klucz nastawny
 DE Rollgabelschlüssel
 RU Ключ разводной

CS Nastavitelný kľúč
 RO Cheie reglabilă
 HU Állítható
 ES Llave ajustable



VOREL

No.	L [mm]	
54061	200	6/60
54062	250	6/36
54063	300	6/24

EN Multipipe wrenches
 PL Klucze uniwersalne
 DE Universalschlüssel
 RU Ключи универсальные
 CS Univerzální kľúče
 RO Chei universale
 HU Univerzális kulcs
 ES Juego de llaves universales



VOREL

No.	Size [mm]	pcs / szt.	
54000	9-22, 23-32	2	20/40

EN Double ratchet wrench
 PL Klucz nasadowy z grzechotką
 DE Gerüstratsche
 RU Ключ торцевой с трещоткой
 CS Ráčnový kľúč prúchozí dvostranný
 RO Cheie tubulară dublă cu cichet
 HU Kettős racsnis kulcs
 ES Llave de vaso con carraca



32T



VOREL

No.	Size / Rozmiar [mm]	
52935	17x19	2/40
52936	19x22	2/40

EN Adjustable wrench
 PL Klucz nastawny
 DE Rollgabelschlüssel
 RU Ключ разводной

CS Nastavitelný kľúč
 RO Cheie reglabilă
 HU Állítható
 ES Llave ajustable



VOREL

No.	L [mm]	
54065	150	6/120
54066	200	6/60
54067	250	6/36
54068	300	6/24

EN Adjustable wrench
 PL Klucz nastawny
 DE Rollgabelschlüssel
 RU Ключ разводной
 CS Nastavitelný klíč
 RO Cheie reglabilă
 HU Állítható
 ES Llave ajustable



VOREL

No.	L [mm]	
54080	375	6/12
54081	450	2/6

EN Torque wrench
 PL Klucz dynamometryczny wychylny
 DE Drehmomentschlüssel
 RU Ключ динамометрический стрелочный
 CS Dynamometrický klíč
 RO Cheie cu dinamometru
 HU Nyomatékkulcs
 ES Llave dinamométrico inclin.



VOREL

No.	Ø	
57450	1/2" (12.7 mm)	6/24

EN Torque wrench
 PL Klucz dynamometryczny
 DE Drehmomentschlüssel
 RU Ключ динамометрический
 CS Dynamometrický klíč
 RO Cheie cu dinamometru
 HU Nyomatékkulcs
 ES Llave dinamométrico



VOREL

No.	Ø	L [mm]	Torque / Moment obrotowy [Nm]	
57300	3/8" (9.5 mm)	270	13.6-108	20
57350	1/2" (12.7 mm)	465	28.0-210	10

EN Adjustable wrench
 PL Klucz nastawny
 DE Rollgabelschlüssel
 RU Ключ разводной

CS Nastavitelný klíč
 RO Cheie reglabilă
 HU Állítható
 ES Llave ajustable



1



VOREL

No.	L [mm]	
54070	150	6/120
54071	200	6/60
54072	250	6/36
54073	300	6/24

EN Torque wrench
 PL Klucz dynamometryczny wychylny
 DE Drehmomentschlüssel
 RU Ключ динамометрический стрелочный
 CS Dynamometrický klíč
 RO Cheie cu dinamometru
 HU Nyomatékkulcs
 ES Llave dinamométrico inclin.

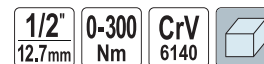

VOREL

No.	Ø	
57451	1/2" (12.7 mm)	16

EN Torque wrench
 PL Klucz dynamometryczny
 DE Drehmomentschlüssel
 RU Ключ динамометрический
 CS Dynamometrický klíč
 RO Cheie cu dinamometru
 HU Nyomatékkulcs
 ES Llave dinamométrica



VOREL

No.	Ø	L [mm]	Torque / Moment obrotowy [Nm]	
57400	3/4" (19.0 mm)	625	68-406	10

2

Sockets, accessories & sets Klucze nasadowe, akcesoria i zestawy



Sockets
Klucze nasadowe



16

Hexagonal sockets 1/2" Klucze nasadowe sześciokątne 1/2"	16
Hexagonal sockets 3/4" Klucze nasadowe sześciokątne 3/4"	16
Universal wrench sockets Nasadki uniwersalne	16

Accessories
Akcesoria

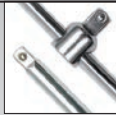

16-17

Extension bars Przedłużki	16
Universal joints Przeguby Cardana	16
Sliding T-bars Pokrętła typu „T”	17
Speed braces Rękojeści wygięte	17

Ratchet handles
Grzechotki



17-18

Socket & tool sets
Zestawy kluczy nasadowych i narzędziowych

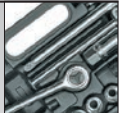

18-23

Socket sets 1/4" Zestawy kluczy nasadowych 1/4"	18
Socket sets 3/8" Zestawy kluczy nasadowych 3/8"	18
Socket sets 1/2" Zestawy kluczy nasadowych 1/2"	18
Socket sets 3/4" Zestawy kluczy nasadowych 3/4"	19
Tool sets Zestawy narzędziowe	19

2

EN Hexagonal socket
PL Nasadka sześciokątna
DE Sechskantenschlüssel
RU Торцевая головка 6-гранная

CS Šestihřanný nástavec
RO Cheie tubulară hexagonală
HU Hatszögű rátét
ES Boquilla hexagonal corta

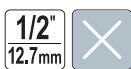

No.	Socket size / Rozmiar nasadki [mm]	Ø	
53100	10	1/2" (12.7 mm)	150/300
53120	12	1/2" (12.7 mm)	150/300
53130	13	1/2" (12.7 mm)	150/300
53140	14	1/2" (12.7 mm)	150/300
53150	15	1/2" (12.7 mm)	150/300
53160	16	1/2" (12.7 mm)	150/300
53170	17	1/2" (12.7 mm)	125/250
53180	18	1/2" (12.7 mm)	100/200
53190	19	1/2" (12.7 mm)	100/200
53220	22	1/2" (12.7 mm)	75/150
53240	24	1/2" (12.7 mm)	50/100
53270	27	1/2" (12.7 mm)	50/100
53300	30	1/2" (12.7 mm)	40/80
53320	32	1/2" (12.7 mm)	40/80

EN Universal wrench socket
PL Nasadka uniwersalna
DE Universal Steckschlüssel
RU Головка универсальная

CS Univerzální šroubovací nástavec
RO Cheie tubulară universală
HU Univerzális dugókulcs
ES Universal llave de cubo



No.	Socket size / Rozmiar nasadki [mm]	Ø	
53002	7-19	3/8" (9.5 mm)	8/48
53003	11-32	1/2" (12.7 mm)	6/24

EN Extension bar
PL Przedłużka
DE Verlängerung
RU Удлинитель для воротка

CS Prodlužovací přípravek
RO Prelungitor
HU Hosszabító
ES Tubo de prolongación



No.	Ø	L [mm]	
53610	1/2" (12.7 mm)	125	50/100
53630	1/2" (12.7 mm)	250	25/50

EN Extension bar
PL Przedłużka
DE Verlängerung
RU Удлинитель для воротка

CS Prodlužovací přípravek
RO Prelungitor
HU Hosszabító
ES Tubo de prolongación



No.	Ø	L [mm]	
53650	3/4" (19.0 mm)	100	60
53670	3/4" (19.0 mm)	200	25

EN Hexagonal socket
PL Nasadka sześciokątna
DE Sechskantenschlüssel
RU Торцевая головка 6-гранная

CS Šestihřanný nástavec
RO Cheie tubulară hexagonală
HU Hatszögű rátét
ES Boquilla hexagonal corta



No.	Socket size / Rozmiar nasadki [mm]	Ø	
53332	10	1/2" (12.7 mm)	10/300
53335	13	1/2" (12.7 mm)	10/300
53336	14	1/2" (12.7 mm)	5/300
53337	15	1/2" (12.7 mm)	5/300
53338	16	1/2" (12.7 mm)	5/300
53339	17	1/2" (12.7 mm)	5/250
53340	18	1/2" (12.7 mm)	10/200
53341	19	1/2" (12.7 mm)	10/200

EN Hexagonal socket
PL Nasadka sześciokątna
DE Sechskantenschlüssel
RU Торцевая головка 6-гранная

CS Šestihřanný nástavec
RO Cheie tubulară hexagonală
HU Hatszögű rátét
ES Boquilla hexagonal corta



No.	Socket size / Rozmiar nasadki [mm]	Ø	
53400	22	3/4" (19.0 mm)	50
53410	24	3/4" (19.0 mm)	50
53420	27	3/4" (19.0 mm)	50
53430	30	3/4" (19.0 mm)	50
53440	32	3/4" (19.0 mm)	50
53450	36	3/4" (19.0 mm)	50
53460	38	3/4" (19.0 mm)	40
53470	41	3/4" (19.0 mm)	25
53480	46	3/4" (19.0 mm)	20
53490	50	3/4" (19.0 mm)	20

EN Universal joint
PL Przegub Cardana
DE Kardangelenk
RU Карданный шарнир
CS Kardanový kloub
RO Articulație Cardanică
HU Kardán csukló
ES Articulación Cardan



No.	Ø	
53600	1/2" (12.7 mm)	50/100

EN Sliding T-bar
 PL Pokrętko typu „T”
 DE Handgriff mit Gleitstück
 RU Вороток Т-образный

CS Otočná račka typ „T”
 RO Măner clupă tipul „T”
 HU „T” alakú hajtókar
 ES Mango tipo „T”



No.	Ø	L [mm]	
53700	1/2" (12.7 mm)	250	25/50

EN Speed brace
 PL Rękojeść wygięta
 DE Kurbelverlängerung
 RU Вороток-колесоворот

CS Ohnutá rukojeť
 RO Măner curbat (manivelă)
 HU Hajlított markolat
 ES Mango encorvado



No.	Ø	L [mm]	
53730	1/2" (12.7 mm)	400	40

EN Ratchet handle
 PL Grzechotka
 DE Hebelumschaltknarre
 RU Трещотка для торцевых головок

CS Řehtačka
 RO Antrenor cu clichet
 HU Racsni
 ES Llave de carraca



No.	Ø	L [mm]	
53561	1/4" (6.3 mm)	135	40/80
53562	3/8" (9.5 mm)	190	25/50
53563	1/2" (12.7 mm)	240	20/40

EN Ratchet handle
 PL Grzechotka
 DE Hebelumschaltknarre
 RU Трещотка с изогнутой ручкой

CS Řehtačka
 RO Antrenor cu clichet
 HU Racsni
 ES Llave de carraca



No.	Ø	L [mm]	Number of teeth / Liczba zębów	
53571	1/4" (6.3 mm)	150	72	6/36
53572	3/8" (9.5 mm)	200	72	6/36
53573	1/2" (12.7 mm)	260	72	6/36

EN Sliding T-bar
 PL Pokrętko typu „T”
 DE Handgriff mit Gleitstück
 RU Вороток Т-образный

CS Otočná račka typ „T”
 RO Măner clupă tipul „T”
 HU „T” alakú hajtókar
 ES Mango tipo „T”



No.	Ø	L [mm]	
53710	3/4" (19.0 mm)	450	20

EN Ratchet handle
 PL Grzechotka
 DE Hebelumschaltknarre
 RU Трещотка для торцевых головок

CS Řehtačka
 RO Antrenor cu clichet
 HU Racsni
 ES Llave de carraca



No.	Ø	L [mm]	
53500	1/4" (6.3 mm)	125	40/80
53520	3/8" (9.5 mm)	195	25/50
53540	1/2" (12.7 mm)	250	20/40

EN Flexible ratchet handle
 PL Grzechotka przegubowa
 DE Gelenk-Hebelumschaltknarre
 RU Трещотка шарнирная

CS Kloubová řehtačka
 RO Antrenor cu clichet, flexibil
 HU Csuklós racsni
 ES Llave de carraca articulada

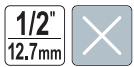

No.	Ø	L [mm]	
53560	1/2" (12.7 mm)	250	25/50

EN Ratchet handle
 PL Grzechotka
 DE Hebelumschaltknarre
 RU Трещотка с пластиковым покрытием

CS Řehtačka
 RO Antrenor cu clichet
 HU Racsni
 ES Llave de carraca



No.	Ø	L [mm]	Number of teeth / Liczba zębów	
53575	1/4" (6.3 mm)	155	72	12/72
53576	3/8" (9.5 mm)	200	72	6/48
53577	1/2" (12.7 mm)	250	72	6/36

- EN Ratchet handle
- PL Grzechołka
- DE Hebelumschaltknarre
- RU Трещотка
- CS Ráčna
- RO Dispozitiv de prindere cu clichet
- HU Racsnis hajtókar
- ES Carraca



No.	Ø	L [mm]	☐
53580	3/4" (19.0 mm)	500	10

- EN Socket set
- PL Komplet nasadek z akcesoriami
- DE Sechskantenschlüssel-Einsatz
- RU Набор торцевых головок
- CS Sada nástrčných klíčů a ráčny
- RO Trusă de scule
- HU Dugókulcs készlet racsnis hajtókarral
- ES Juego de boquillas con accesorios



1/4" (6.3 mm): 4, 4.5, 5, 5.5, 6, 7, 8, 9, 10, 11, 12 mm; 3/8" (9.5 mm): 13, 14, 17 mm; 3/8" (9.5 mm) x 21 mm; 3/8" (9.5 mm) x 70 mm; 1/4" (6.3 mm) x 3/8" (9.5 mm); 1/4" (6.3 mm) x 50 mm; 3/8" (9.5 mm) x 190 mm; 3/8" (9.5 mm)

No.	Ø	pcs / szt.	☐
58210	1/4" (6.3 mm), 3/8" (9.5 mm)	20	10

- EN Socket set
- PL Komplet nasadek z akcesoriami
- DE Sechskantenschlüssel-Einsatz
- RU Набор торцевых головок
- CS Sada nástrčných klíčů a ráčny
- RO Trusă de scule
- HU Dugókulcs készlet racsnis hajtókarral
- ES Juego de boquillas con accesorios



1/2" (12.7 mm): 10, 11, 12, 13, 14, 15, 16, 17, 18, 19, 20, 21, 22, 23, 24, 27, 30, 32 mm; 1/2" (12.7 mm) x 21 mm; 1/2" (12.7 mm) x 125 mm; 1/2" (12.7 mm) x 250 mm; 1/2" (12.7 mm) x 250 mm; 1/2" (12.7 mm) x 240 mm; 1/2" (12.7 mm) x 390 mm

No.	Ø	pcs / szt.	☐
58260	1/2" (12.7 mm)	24	5

- EN Socket set
- PL Komplet nasadek z akcesoriami
- DE Sechskantenschlüssel-Einsatz
- RU Набор торцевых головок
- CS Sada nástrčných klíčů a ráčny
- RO Trusă de scule
- HU Dugókulcs készlet racsnis hajtókarral
- ES Juego de boquillas con accesorios



1/4" (6.3 mm): 4, 4.5, 5, 5.5, 6, 6.5, 7, 8, 9, 10, 11, 12, 13 mm; 1/4" (6.3 mm) x 50 mm; 1/4" (6.3 mm) x 120 mm; 1/4" (6.3 mm)

No.	Ø	pcs / szt.	☐
58160	1/4" (6.3 mm)	16	20

- EN Socket set
- PL Komplet nasadek z akcesoriami
- DE Sechskantenschlüssel-Einsatz
- RU Набор торцевых головок
- CS Sada nástrčných klíčů a ráčny
- RO Trusă de scule
- HU Dugókulcs készlet racsnis hajtókarral
- ES Juego de boquillas con accesorios



1/2" (12.7 mm): 8, 9, 10, 11, 12, 13, 14, 15, 16, 17, 18, 19, 20, 21, 22, 23, 24, 27, 30 mm; 1/2" (12.7 mm) x 125 mm; 1/2" (12.7 mm) x 250 mm; 1/2" (12.7 mm) x 240 mm; 1/2" (12.7 mm)

No.	Ø	pcs / szt.	☐
58240	1/2" (12.7 mm)	24	5

- EN Ratchet handle with socket set
- PL Komplet nasadek z grzechołką
- DE Sechskant-Steckschlüssel-Satz
- RU Трещотка с насадками
- CS Sada nástrčných klíčů a ráčny
- RO Trusă de scule
- HU Dugókulcs készlet racsnis hajtókarral
- ES Matraca con boquillas



No.	Socket size / Rozmiar nasadki [mm]	L [mm]	Ø	☐
58600	5, 6, 7, 8, 9, 10, 11, 12, 13, 14	150	1/4" (6.3 mm)	6/24
58602	10, 11, 12, 13, 14, 15, 17, 19, 22, 24	260	1/2" (12.7 mm)	12

EN Socket set
 PL Komplet nasadek z akcesoriami
 DE Sechskantenschlüssel-Einsatz
 RU Набор торцевых головок
 CS Sada nástrčných klíčů a ráčny
 RO Trusă de scule
 HU Dugókulcs készlet racsnis hajtókkal
 ES Juego de boquillas con accesorios

12 PCS **1/2"** 12.7mm **45T** AS-DRIVE



1/2" (12.7 mm): 10, 11, 12, 13, 14, 15, 17, 19, 21, 24 mm;
 1/2" (12.7 mm);
 1/2" (12.7 mm); 45T

No.	Ø	pcs / szl.	📦
58633	1/2" (12.7 mm)	12	5/10

EN Socket set
 PL Komplet nasadek z akcesoriami
 DE Sechskantenschlüssel-Einsatz
 RU Набор торцевых головок

CS Sada nástrčných klíčů a ráčny
 RO Trusă de scule
 HU Dugókulcs készlet racsnis hajtókkal
 ES Juego de boquillas con accesorios

14 PCS **3/4"** 19mm



3/4" (19.0 mm): 22, 24, 27, 30, 32, 36, 38, 41, 46, 50 mm;
 3/4" (19.0 mm) x 100; 200 mm;
 3/4" (19.0 mm) x 456 mm; 3/4" (19.0 mm) x 495 mm

No.	Ø	pcs / szl.	📦
58140	3/4" (19.0 mm)	14	2

EN Tool set
 PL Zestaw narzędziowy
 DE Sechskant-Steckschlüssel-Satz
 RU Набор торцевых головок

CS Sada nástrčných klíčů a ráčny
 RO Trusă de scule
 HU Dugókulcs készlet racsnis hajtókkal
 ES Juego de herramientas

38 PCS **1/4"** 6.3mm **45T** AS-DRIVE



1/4" (6.3 mm): 3.5, 4, 4.5, 5, 5.5, 6, 7, 8, 9, 10, 11, 12, 13, 14 mm;
 1/4" (6.3 mm); 1/4" (6.3 mm); 1/4" (6.3 mm);
 1/4" (6.3 mm) x 2; 1/4" (6.3 mm); 1/4" (6.3 mm);
 1/4" (6.3 mm); 4, 5, 5, 6.5 mm; 1/4" (6.3 mm); PH1, PH2;
 1/4" (6.3 mm); PZ1, PZ2; 1/4" (6.3 mm);
 1/4" (6.3 mm); T10, T15, T20, T25, T30, T40;
 1/4" (6.3 mm); 3, 4, 5, 6, 8 mm

No.	Ø	pcs / szl.	📦
58640	1/4" (6.3 mm)	38	10

EN Ratchet handle with socket set
 PL Komplet nasadek z grzechotką
 DE Sechskant-Steckschlüssel-Satz
 RU Трещотка с насадками
 CS Sada nástrčných klíčů a ráčny
 RO Trusă de scule
 HU Dugókulcs készlet racsnis hajtókkal
 ES Matraca con boquillas

19 PCS **1/2"** 12.7mm **45T** AS-DRIVE



1/2" (12.7 mm): 8, 9, 10, 11, 12, 13, 14, 15, 16, 17, 19, 21, 22, 23, 24, 27, 30, 32 mm;
 1/2" (12.7 mm); 45T

No.	Ø	pcs / szl.	📦
58634	1/2" (12.7 mm)	19	4/8

EN Socket set
 PL Komplet nasadek z akcesoriami
 DE Sechskant-Steckschlüssel-Einsatz
 RU Набор торцевых головок

CS Sada nástrčných klíčů a ráčny
 RO Trusă de scule
 HU Dugókulcs készlet racsnis hajtókkal
 ES Juego de boquillas con accesorios

20 PCS **3/4"** 19mm



3/4" (19.0 mm): 22, 24, 26, 27, 28, 30, 32, 34, 36, 38, 41, 42, 45, 46, 48, 50 mm;
 3/4" (19.0 mm) x 100; 200 mm;
 3/4" (19.0 mm) x 456 mm;
 3/4" (19.0 mm) x 495 mm

No.	Ø	pcs / szl.	📦
58150	3/4" (19.0 mm)	20	2

EN Tool set
 PL Zestaw narzędziowy
 DE Sechskant-Steckschlüssel-Satz
 RU Набор торцевых головок

CS Sada nástrčných klíčů a ráčny
 RO Trusă de scule
 HU Dugókulcs készlet racsnis hajtókkal
 ES Juego de herramientas

42 PCS **1/4"** 6.3mm **45T** AS-DRIVE



1/4" (6.3 mm): 4, 4.5, 5, 5.5, 6, 7, 8, 9, 10, 11, 12, 13, 14 mm; 1/4" (6.3 mm); 8, 9, 10, 11, 12, 13 mm;
 1/4" (6.3 mm) x 2; 1/4" (6.3 mm); 1/4" (6.3 mm); 1/4" (6.3 mm);
 1/4" (6.3 mm); 45T; 1/4" (6.3 mm); 1/4" (6.3 mm);
 1/4" (6.3 mm); 3, 4, 5 mm; 1/4" (6.3 mm); PH0, PH1, PH2;
 1/4" (6.3 mm); PZ0, PZ1, PZ2; 1/4" (6.3 mm); 6, 7, 8 mm; 1.5, 2, 2.5 mm

No.	Ø	pcs / szl.	📦
58641	1/4" (6.3 mm)	42	10

EN Tool set
 PL Zestaw narzędziowy
 DE Sechskant-Steckschlüssel-Satz
 RU Набор торцовых головок

CS Sada nástrčných klíčů a ráčny
 RO Trusă de scule
 HU Dugókulcs készlet racsnis hajtókarral
 ES Juego de herramientas

56 PCS
 1/4" 6.3mm
 CrV 50BV30
 45T
 AS-DRIVE



1/4" (6.3 mm): 4, 4.5, 5, 5.5, 6, 7, 8, 9, 10, 11, 12, 13 mm; 1/4" (6.3 mm): 6, 7, 8, 9, 10, 11, 12, 13 mm; 1/4" (6.3 mm): E4, E5, E6, E7, E8, E10; CrV 50BV30; 1/4" (6.3 mm) x2; 1/4" (6.3 mm); 1/4" (6.3 mm); 1/4" (6.3 mm); 1/4" (6.3 mm); 1/4" (6.3 mm); 1/4" (6.3 mm) (F) x 3/8" (9.5 mm) (M); 1/4" (6.3 mm); 1/4" (6.3 mm); 1/4" (6.3 mm); PH1, PH2, PH3; 1/4" (6.3 mm); PZ1, PZ2, PZ3; 1/4" (6.3 mm); T8, T10, T15, T20, T25, T30, T40; 1/4" (6.3 mm); 3, 4, 5, 7, 6, 8 mm



No.	Ø	pcs / szt.	☐
58643	1/4" (6.3 mm)	56	10

EN Tool set
 PL Zestaw narzędziowy
 DE Sechskant-Steckschlüssel-Satz
 RU Набор торцовых головок
 CS Sada nástrčných klíčů a ráčny
 RO Trusă de scule
 HU Dugókulcs készlet racsnis hajtókarral
 ES Juego de herramientas

94 PCS
 1/2" 12.7mm
 1/4" 6.3mm
 45T
 AS-DRIVE



1/2" (12.7 mm): 10, 11, 12, 13, 14, 15, 16, 17, 18, 19, 20, 21, 22, 23, 24, 27, 30, 32; 1/4" (6.3 mm): 4, 4.5, 5, 5.5, 6, 7, 8, 9, 10, 11, 12, 13, 14 mm; 1/2" (12.7 mm): 14, 15, 17, 19 mm; 1/4" (6.3 mm): 6, 7, 8, 9, 10, 11, 12, 13 mm; 1/2" (12.7 mm) x2; 1/4" (6.3 mm) x2; 3/8" (9.5 mm) (F) x 1/2" (12.7 mm) (M); 1/4" (6.3 mm); 1/2" (12.7 mm); 1/4" (6.3 mm); 1/2" (12.7 mm); 16, 21 mm; 1/4" (6.3 mm); 1/2" (12.7 mm); 1/4" (6.3 mm); 45T; 1/4" (6.3 mm); 1/2" (12.7 mm) x 5/16" (7.9 mm); 1/4" (6.3 mm) x 1/4" (6.3 mm); 5/16" (7.9 mm); 8, 10, 12 mm; 5/16" (7.9 mm); PH3, PH4; 5/16" (7.9 mm); PZ3, PZ4; 5/16" (7.9 mm); T40, T45, T50, T55; 5/16" (7.9 mm); 8, 10, 12, 14 mm; 1/4" (6.3 mm); 4, 5.5, 7 mm; 1/4" (6.3 mm); PH1, PH2; 1/4" (6.3 mm); PZ1, PZ2; 1/4" (6.3 mm); T8, T10, T15, T20, T25, T30; 1/4" (6.3 mm); 3, 4, 5, 6 mm; 1.5, 2, 2.5 mm



No.	Ø	pcs / szt.	☐
58687	1/4" (6.3 mm), 1/2" (12.7 mm)	94	3

EN Tool set
 PL Zestaw narzędziowy
 DE Sechskant-Steckschlüssel-Satz
 RU Набор торцовых головок
 CS Sada nástrčných klíčů a ráčny
 RO Trusă de scule
 HU Dugókulcs készlet racsnis hajtókarral
 ES Juego de herramientas

22 PCS
 3/8" 9.5mm
 45T
 AS-DRIVE



3/8" (9.5 mm): 6, 7, 8, 9, 10, 11, 12, 13, 14, 15, 16, 17, 18, 19, 20, 21, 22 mm; 3/8" (9.5 mm); 3/8" (9.5 mm); 3/8" (9.5 mm); 45T



No.	Ø	pcs / szt.	☐
58661	3/8" (9.5 mm)	22	10

EN Tool set
 PL Zestaw narzędziowy
 DE Sechskant-Steckschlüssel-Satz
 RU Набор торцовых головок
 CS Sada nástrčných klíčů a ráčny
 RO Trusă de scule
 HU Dugókulcs készlet racsnis hajtókarral
 ES Juego de herramientas

108 PCS
 1/2" 12.7mm
 1/4" 6.3mm
 CrV 50BV30
 45T
 AS-DRIVE



1/2" (12.7 mm): 10, 11, 12, 13, 14, 15, 16, 17, 18, 19, 20, 21, 22, 24, 27, 30, 32 mm; 1/4" (6.3 mm): 4, 4.5, 5, 5.5, 6, 7, 8, 9, 10, 11, 12, 13, 14 mm; 1/2" (12.7 mm): 14, 15, 17, 19, 22 mm; 1/4" (6.3 mm): 6, 7, 8, 9, 10, 11, 12, 13 mm; 1/2" (12.7 mm): E10, E11, E12, E14, E16, E18, E20, E24; 1/4" (6.3 mm): E4, E5, E6, E7, E8; CrV 50BV30; 1/2" (12.7 mm) x2; 1/4" (6.3 mm) x2; 3/8" (9.5 mm) (F) x 1/2" (12.7 mm) (M); 1/2" (12.7 mm); 1/4" (6.3 mm); 1/2" (12.7 mm); 16, 21 mm; 1/4" (6.3 mm); 1/2" (12.7 mm); 1/4" (6.3 mm); 45T; 1/4" (6.3 mm); 1/2" (12.7 mm) (F) x 5/16" (7.9 mm) (F); 5/16" (7.9 mm); 8, 10, 12 mm; 5/16" (7.9 mm); PH3, PH4; 5/16" (7.9 mm); PZ3, PZ4; 5/16" (7.9 mm); T40, T45, T50, T55, T60; 5/16" (7.9 mm); 7, 8, 10, 12, 14 mm; 1/4" (6.3 mm); 4, 5.5, 6.5 mm; 1/4" (6.3 mm); PH1, PH2; 1/4" (6.3 mm); PZ1, PZ2; 1/4" (6.3 mm); T8, T10, T15, T20, T25, T27, T30; 1/4" (6.3 mm); 3, 4, 5, 6 mm; 1.5, 2, 2.5 mm



No.	Ø	pcs / szt.	☐
58685	1/4" (6.3 mm), 1/2" (12.7 mm)	108	3

EN Tool set
 PL Zestaw narzędziowy
 DE Sechskant-Steckschlüssel-Satz
 RU Набор торцовых головок
 CS Sada nástrčných klíčů a ráčny
 RO Trusă de scule
 HU Dugókulcs készlet racsnis hajtókarral
 ES Juego de herramientas

122 PCS	1/2" 12.7mm	1/4" 6.3mm	CrV 50BV30
CrV 6150	45T	AS-DRIVE	

2



1/2" (12.7 mm): 12, 13, 14, 15, 16, 17, 18, 19, 20, 21, 22, 24, 27, 30, 32 mm; 1/4" (6.3 mm): 4, 4.5, 5, 5.5, 6, 7, 8, 9, 10, 11, 12, 13, 14 mm; 1/2" (12.7 mm): 10, 12, 13, 14, 17, 19 mm; 1/4" (6.3 mm): 4, 5, 6, 7, 8, 9 mm; 1/2" (12.7 mm): E10, E12, E14, E16, E18, E20, E22, E24; CrV 50BV30; 1/2" (12.7 mm); 1/4" (6.3 mm); 3/8" (9.5 mm) (F) x 1/2" (12.7 mm) (M); 3/8" (9.5 mm) (F) x 1/4" (6.3 mm) (M); 1/2" (12.7 mm); 1/4" (6.3 mm); 1/2" (12.7 mm): 16, 21 mm; 1/2" (12.7 mm); 1/4" (6.3 mm); 45T; 1/4" (6.3 mm); 1/4" (6.3 mm) x 1/4" (6.3 mm); 1/4" (6.3 mm); 3, 4, 5, 6 mm; 1/4" (6.3 mm); PH0, PH1, PH2; 1/4" (6.3 mm); PZ0, PZ1, PZ2; 1/4" (6.3 mm): 4.0, 5.5, 6.5 mm; 1/4" (6.3 mm): PH1, PH2, PH3; 1/4" (6.3 mm): PZ2, PZ3; 1/4" (6.3 mm): T8, T10, T15, T20, T25; 1/4" (6.3 mm): T10, T15, T20, T25, T40; 1/4" (6.3 mm): 3, 4, 5, 6 mm; 8, 9, 10, 11, 12, 13, 14, 15, 16, 17, 18, 19 mm; 4x100, 6.5x150, PH2x100, PH3x150 mm; CrV 6150; 160 mm; 160 mm; 180 mm; 250 mm; 300 g; 2, 2.5, 3, 4, 5, 6, 7, 8, 10 mm



No.	Ø	pcs / szt.	
58690	1/4" (6.3 mm), 1/2" (12.7 mm)	122	2

EN Tool set
 PL Zestaw narzędziowy
 DE Sechskant-Steckschlüssel-Satz
 RU Набор торцовых головок
 CS Sada nástrčných klíčů a ráčny
 RO Trusă de scule
 HU Dugókulcs készlet racsnis hajtókarral
 ES Juego de herramientas

173 PCS	1/2" 12.7mm	3/8" 9.5mm	1/4" 6.3mm
CrV 50BV30	45T	AS-DRIVE	



1/2" (12.7 mm): 10, 11, 12, 13, 14, 15, 16, 17, 18, 19, 20, 21, 22, 23, 24, 27, 30, 32 mm; 3/8" (9.5 mm): 10, 11, 12, 13, 14, 15, 16, 17, 18, 19 mm; 1/4" (6.3 mm): 4, 4.5, 5, 5.5, 6, 7, 8, 9, 10, 11, 12, 13, 14 mm; 1/2" (12.7 mm): 16, 17, 18, 19, 22 mm; 3/8" (9.5 mm): 10, 11, 12, 13, 14, 15 mm; 1/4" (6.3 mm): 4, 5, 6, 7, 8, 9, 10 mm; 1/2" (12.7 mm): E18, E20, E24; 3/8" (9.5 mm): E10, E11, E12, E14, E16; 1/4" (6.3 mm): E4, E5, E6, E7, E8; CrV 50BV30; 1/2" (12.7 mm) x2; 3/8" (9.5 mm) x2; 1/4" (6.3 mm) x2; 3/8" (9.5 mm) (F) x 1/2" (12.7 mm) (M); 1/2" (12.7 mm); 3/8" (9.5 mm); 1/4" (6.3 mm); 1/2" (12.7 mm); 1/4" (6.3 mm); 18 mm; 1/4" (6.3 mm); 1/2" (12.7 mm); 3/8" (9.5 mm); 1/4" (6.3 mm); 45T; 1/4" (6.3 mm); 1/2" (12.7 mm) x 5/16" (7.9 mm); 3/8" (9.5 mm) x 5/16" (7.9 mm); 1/4" (6.3 mm) x 1/4" (6.3 mm); 5/16" (7.9 mm); 8, 10, 12 mm; 5/16" (7.9 mm); PH3, PH4; 5/16" (7.9 mm); PZ3, PZ4; 5/16" (7.9 mm); T40, T45, T50, T55, T60, T70; 5/16" (7.9 mm): T40, T45, T50, T55, T60, T70; 5/16" (7.9 mm): 7, 8, 10, 12, 14 mm; 1/4" (6.3 mm): T5, T6, T7; 1/4" (6.3 mm): T7, T10, T15, T20, T25, T27, T30, T40, T45; 1/4" (6.3 mm): M5, M6, M8; 1/4" (6.3 mm): RM5, RM6, RM7, RM8, RM9; 1/4" (6.3 mm): 4, 5, 5.5, 6, 7 mm; 1/4" (6.3 mm): PH0, PH1, PH2; 1/4" (6.3 mm): PZ0, PZ1, PZ2; 1/4" (6.3 mm): T8, T9, T10, T15, T20, T25, T27, T30; 1/4" (6.3 mm): T8, T9, T10, T15, T20, T25, T27, T30; 1.25, 1.5, 2, 2.5, 3, 4, 5 mm



No.	Ø	pcs / szt.	
58688	1/4" (6.3 mm), 3/8" (9.5 mm), 1/2" (12.7 mm)	173	1

EN Tool set
 PL Zestaw narzędziowy
 DE Sechskant-Steckschlüssel-Satz
 RU Набор торцовых головок
 CS Sada nástrčných klíčů a ráčny
 RO Trusă de scule
 HU Dugókulcs készlet racsnis hajtókarral
 ES Juego de herramientas

2

216 PCS 1/2" 12.7mm 3/8" 9.5mm 1/4" 6.3mm CrV 50BV30
 CrV 6140 45T AS-DRIVE

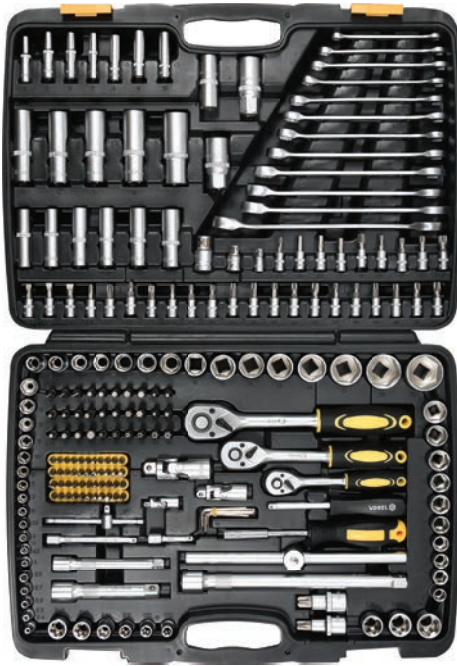

No.	Ø	pcs / szt.	☐
58700	1/4" (6.3 mm), 3/8" (9.5 mm), 1/2" (12.7 mm)	216	1

EN Tool set
 PL Zestaw narzędziowy
 DE Sechskant-Steckschlüssel-Satz
 RU Набор торцовых головок
 CS Sada nástrčných klíčů a ráčny
 RO Trusă de scule
 HU Dugókulcs készlet racsnis hajtókarral
 ES Juego de herramientas

216 PCS 1/2" 12.7mm 3/8" 9.5mm 1/4" 6.3mm CrV 50BV30 45T AS-DRIVE



No.	Ø	pcs / szt.	☐
58691	1/4" (6.3 mm), 3/8" (9.5 mm), 1/2" (12.7 mm)	216	1

1/2" (12.7 mm): 10, 11, 12, 13, 14, 15, 17, 19, 20, 21, 22, 24, 27, 30, 32 mm; 3/8" (9.5 mm): 10, 11, 12, 13, 14, 15, 16, 17, 18, 19 mm; 1/4" (6.3 mm): 4, 4.5, 5, 5.5, 6, 7, 8, 9, 10, 11, 12, 13, 14 mm; 1/2" (12.7 mm): 16, 17, 18, 19, 22 mm; 3/8" (9.5 mm): 10, 11, 12, 13, 14, 15 mm; 1/4" (6.3 mm): 4, 5, 6, 7, 8, 9, 10 mm; 1/2" (12.7 mm): E20, E22, E24; 3/8" (9.5 mm): E10, E11, E12, E14, E16, E18; 1/4" (6.3 mm): E4, E5, E6, E7, E8; CrV 50BV30; 1/2" (12.7 mm) x2; 3/8" (9.5 mm); 1/4" (6.3 mm) x2; 1/2" (12.7 mm); 3/8" (9.5 mm); 1/4" (6.3 mm); 1/2" (12.7 mm): 16, 21 mm; 3/8" (9.5 mm): 18 mm; 1/2" (12.7 mm); 1/4" (6.3 mm); 1/2" (12.7 mm); 3/8" (9.5 mm); 1/4" (6.3 mm); 45T; 1/4" (6.3 mm); 1/4" (6.3 mm); 1/2" (12.7 mm) x 5/16" (7.9 mm); 3/8" (9.5 mm) x 5/16" (7.9 mm); 1/4" (6.3 mm) x 1/4" (6.3 mm); 5/16" (7.9 mm): 6, 6.5, 8 mm; 1/4" (6.3 mm): 4, 5.5, 6.5 mm; CrV 6140; 5/16" (7.9 mm): PH3, PH4; 1/4" (6.3 mm): PH1, PH2; CrV 6140; 5/16" (7.9 mm): PZ3, PZ4; 1/4" (6.3 mm): PZ1, PZ2; CrV 6140; 5/16" (7.9 mm): T25, T27, T30, T35, 2xT40, T45, T50; 1/4" (6.3 mm): T8, T10, T15, T20, T25; CrV 6140; 5/16" (7.9 mm): T27, T30, T35, T40, T45, T50; 1/4" (6.3 mm): T8, 2xT10, 2xT15, 2xT20, 2xT25, T40; CrV 6140; 5/16" (7.9 mm): 5.5, 6, 6.5, 7, 8 mm; 1/4" (6.3 mm): 3, 4, 5, 6 mm; CrV 6140; 1/4" (6.3 mm): 3, 4, 5, 6 mm; CrV 6140; 5/16" (7.9 mm): M5, M6, M8, M10; 1/4" (6.3 mm): M5, M6, M8; CrV 6140; 1/4" (6.3 mm): S1, S2; CrV 6140; 1/4" (6.3 mm): 1, 2, 3 mm; CrV 6140; 1/4" (6.3 mm): 6, 8, 10 mm; CrV 6140; 1/4" (6.3 mm): 4, 6, 8 mm; CrV 6140; 1/4" (6.3 mm): 6, 6.5, 8 mm; CrV 6140; 1/4" (6.3 mm): PH3, PH4; CrV 6140; 1/4" (6.3 mm): PZ3, PZ4; CrV 6140; 1/2" (12.7 mm): T55, T60; 1/4" (6.3 mm): T25, T27, T30, T35, 2xT40, T45, T50; CrV 6140; 1/4" (6.3 mm): T27, T30, T35, T40, T45, T50; CrV 6140; 1/4" (6.3 mm): 5.5, 6, 6.5, 7, 8 mm; CrV 6140; 1/4" (6.3 mm): M5, M6, M8, M10; CrV 6140; 8, 10, 11, 12, 13, 14, 15, 16, 17, 18, 19, 22 mm; 1.27, 1.5, 2, 2.5, 3, 4, 5 mm

1/2" (12.7 mm): 10, 11, 12, 13, 14, 15, 17, 19, 20, 21, 22, 24, 27, 30, 32 mm; 3/8" (9.5 mm): 10, 11, 12, 13, 14, 15, 16, 17, 18, 19 mm; 1/4" (6.3 mm): 4, 4.5, 5, 5.5, 6, 7, 8, 9, 10, 11, 12, 13, 14 mm; 1/2" (12.7 mm): 16, 17, 18, 19, 22 mm; 3/8" (9.5 mm): 10, 11, 12, 13, 14, 15 mm; 1/4" (6.3 mm): 4, 5, 6, 7, 8, 9, 10 mm; 1/2" (12.7 mm): E20, E22, E24; 3/8" (9.5 mm): E10, E11, E12, E14, E16, E18; 1/4" (6.3 mm): E4, E5, E6, E7, E8; CrV 50BV30; 1/2" (12.7 mm) x2; 3/8" (9.5 mm); 1/4" (6.3 mm) x2; 1/2" (12.7 mm); 3/8" (9.5 mm); 1/4" (6.3 mm); 1/2" (12.7 mm): 16, 21 mm; 3/8" (9.5 mm): 18 mm; 1/2" (12.7 mm); 1/4" (6.3 mm); 1/2" (12.7 mm); 3/8" (9.5 mm); 1/4" (6.3 mm); 45T; 1/4" (6.3 mm); 1/4" (6.3 mm); 1/2" (12.7 mm) x 5/16" (7.9 mm); 3/8" (9.5 mm) x 5/16" (7.9 mm); 1/4" (6.3 mm) x 1/4" (6.3 mm); 5/16" (7.9 mm): 6, 6.5, 8 mm; 1/4" (6.3 mm): 4, 5.5, 6.5 mm; 5/16" (7.9 mm): PH3, PH4; 1/4" (6.3 mm): PH1, PH2; 5/16" (7.9 mm): PZ3, PZ4; 1/4" (6.3 mm): PZ1, PZ2; 5/16" (7.9 mm): T25, T27, T30, T35, 2xT40, T45, T50; 1/4" (6.3 mm): T8, T10, T15, T20, T25; 5/16" (7.9 mm): T27, T30, T35, T40, T45, T50; 1/4" (6.3 mm): T8, 2xT10, 2xT15, 2xT20, 2xT25, T40; 5/16" (7.9 mm): 5.5, 6, 6.5, 7, 8 mm; 1/4" (6.3 mm): 3, 4, 5, 6 mm; 1/4" (6.3 mm): 3, 4, 5, 6 mm; 5/16" (7.9 mm): M5, M6, M8, M10; 1/4" (6.3 mm): M5, M6, M8; 1/4" (6.3 mm): S1, S2; 1/4" (6.3 mm): 1, 2, 3 mm; 1/4" (6.3 mm): 6, 8, 10 mm; 1/4" (6.3 mm): 4, 6, 8 mm; 1/4" (6.3 mm): 6, 6.5, 8 mm; 1/4" (6.3 mm): PH3, PH4; 1/4" (6.3 mm): PZ3, PZ4; 1/2" (12.7 mm): T55, T60; 1/4" (6.3 mm): T25, T27, T30, T35, 2xT40, T45, T50; 1/4" (6.3 mm): T27, T30, T35, T40, T45, T50; 1/4" (6.3 mm): 5.5, 6, 6.5, 7, 8 mm; 1/4" (6.3 mm): M5, M6, M8, M10; 8, 10, 11, 12, 13, 14, 15, 16, 17, 18, 19, 22 mm; 1.27, 1.5, 2, 2.5, 3, 4, 5 mm

EN Tool set
 PL Zestaw narzędziowy
 DE Sechskant-Steckschlüssel-Satz
 RU Набор торцовых головок

CS Sada nástrčných klíčů a ráčny
 RO Trusă de scule
 HU Dugókulcs készlet racsnis hajtókarral
 ES Juego de herramientas

225 PCS 1/2" 12.7mm 3/8" 9.5mm 1/4" 6.3mm CrV 6140 45T AS-DRIVE METRIC SAE



1/2" (12.7 mm): 10, 13, 15, 16, 17, 18, 19, 20, 21, 22, 23, 24, 27, 30, 32 mm; 3/8" (9.5 mm): 10, 11, 12, 13, 14, 15, 16, 17, 18, 19 mm; 1/4" (6.3 mm): 3.5, 4, 4.5, 5, 5.5, 6, 7, 8, 9, 10, 11, 12, 13, 14 mm; 1/2" (12.7 mm): 10, 11, 12, 13, 14, 15, 17, 19, 21 mm; 3/8" (9.5 mm): 6, 7, 8, 9, 10 mm; 1/2" (12.7 mm): 7/16" (11.1 mm), 1/2" (12.7 mm), 9/16" (14.3 mm), 5/8" (15.9 mm), 11/16" (17.5 mm), 3/4" (19.0 mm), 13/16" (20.6 mm), 7/8" (22.2 mm); 1/4" (6.3 mm): 1/4" (6.3 mm), 9/32" (7.1 mm), 5/16" (7.9 mm), 11/32" (8.7 mm), 3/8" (9.5 mm); 1/2" (12.7 mm): 17, 19, 21 mm; 1/2" (12.7 mm): E16, E18, E20, E22, E24; 3/8" (9.5 mm): E10, E11, E12, E14; 1/4" (6.3 mm): E4, E5, E6, E7, E8; 1/2" (12.7 mm) x2, 3/8" (9.5 mm) x2, 1/4" (6.3 mm) x2; 3/8" (9.5 mm) (F) x 1/2" (12.7 mm) (M), 1/2" (12.7 mm) (F) x 3/8" (9.5 mm) (M); 1/2" (12.7 mm), 3/8" (9.5 mm), 1/4" (6.3 mm); 1/2" (12.7 mm): 16, 21 mm, 3/8" (9.5 mm): 18 mm; 1/4" (6.3 mm); 1/2" (12.7 mm), 3/8" (9.5 mm), 1/4" (6.3 mm); 45T; 1/4" (6.3 mm); 1/4" (6.3 mm); 1/2" (12.7 mm) x 5/16" (7.9 mm), 3/8" (9.5 mm) x 5/16" (7.9 mm), 3/8" (9.5 mm) x 1/4" (6.3 mm), 1/4" (6.3 mm) x 1/4" (6.3 mm); 3/8" (9.5 mm) x 1/4" (6.3 mm), 1/4" (6.3 mm) x 1/4" (6.3 mm) x2; 1/4" (6.3 mm) x 1/4" (6.3 mm); 5/16" (7.9 mm): 8, 10 mm; 1/4" (6.3 mm): 3, 4, 5.5, 6.5, 7, 8, 9 mm; CrV 6140; 5/16" (7.9 mm): PH3, PH4; 1/4" (6.3 mm): PH0, PH1, PH2, PH3; CrV 6140; 5/16" (7.9 mm): PZ3, PZ4; 1/4" (6.3 mm): PZ0, PZ1, PZ2, PZ3; CrV 6140; 5/16" (7.9 mm): T20, T25, T27, T30, T40, T45, T50, T55 (L=75 mm); T40, T45, T50, T55, T60, T70 (L=30 mm); 1/4" (6.3 mm): T8, T9, T10, T15, T20, T25, T27, T30; 5/16" (7.9 mm): T40, T45, T50, T55, T60, T70; 1/4" (6.3 mm): T8, T9, T10, T15, T20, T25, T27, T30; CrV 6140; 5/16" (7.9 mm): 10, 12, 14 mm; 1/4" (6.3 mm): 3, 4, 5, 6, 7, 8 mm; CrV 6140; 1/4" (6.3 mm): 4, 5, 6, 7, 8 mm; CrV 6140; 1/4" (6.3 mm): M5, M6, M8, M10; CrV 6140; 1/4" (6.3 mm): S1, S2; CrV 6140; 1/4" (6.3 mm): 1, 2, 3, 4; CrV 6140; 1/4" (6.3 mm): 6, 8, 10; CrV 6140; 1/4" (6.3 mm): 4, 6, 8, 10 mm; CrV 6140; 8, 9, 10, 11, 12, 13, 14, 15, 16, 17, 19, 22 mm; 6x38, PH2x38; 180 mm; 250 mm; 2, 2.5, 3, 4, 5, 6, 7, 8, 10, 12 mm



No.	Diagram	pcs / szt.	Icon
58693	1/4" (6.3 mm), 3/8" (9.5 mm), 1/2" (12.7 mm)	225	1

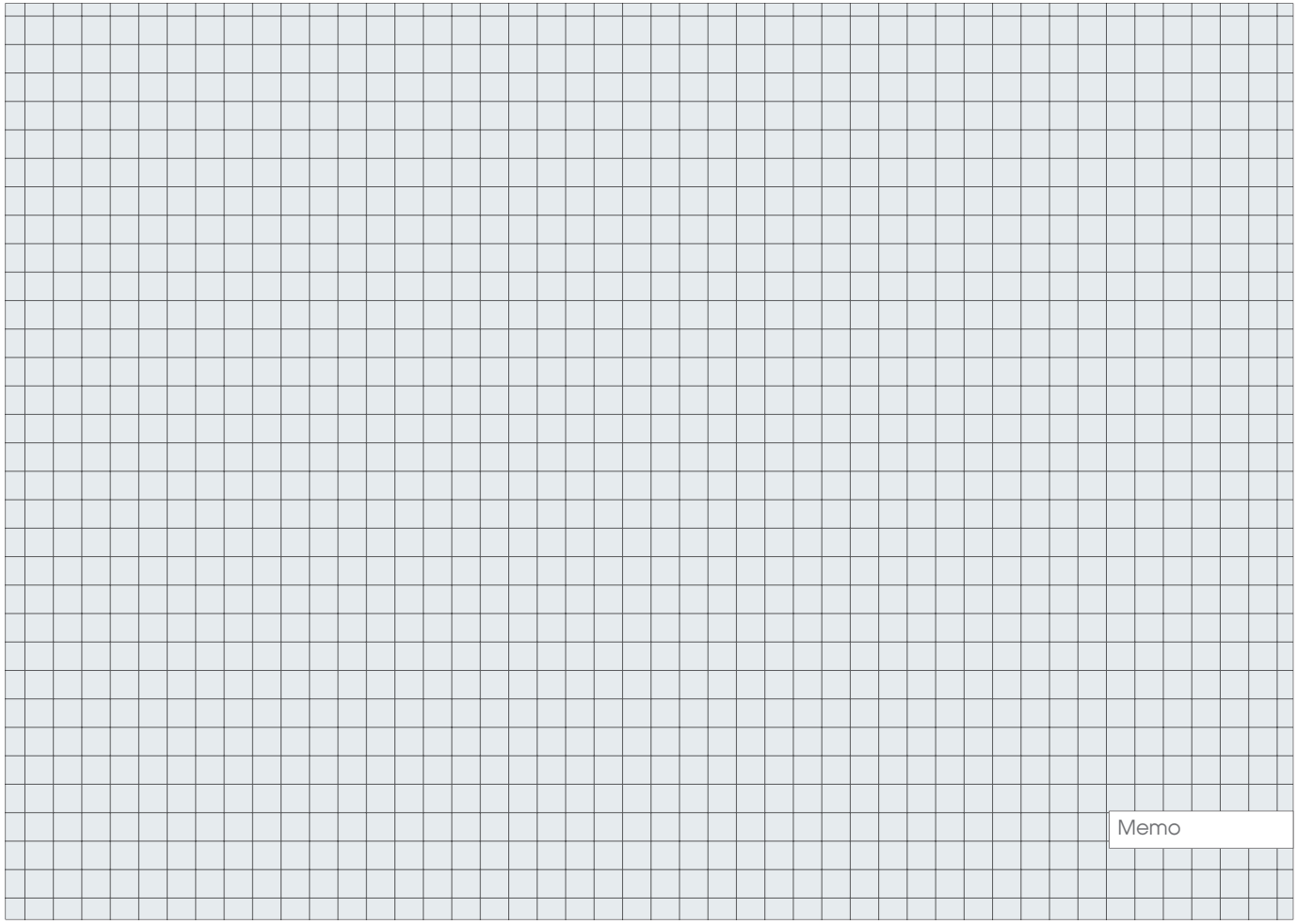

3

Screwdrivers & screwdriver bits Wkrętaki i końcówki wkrętakowe

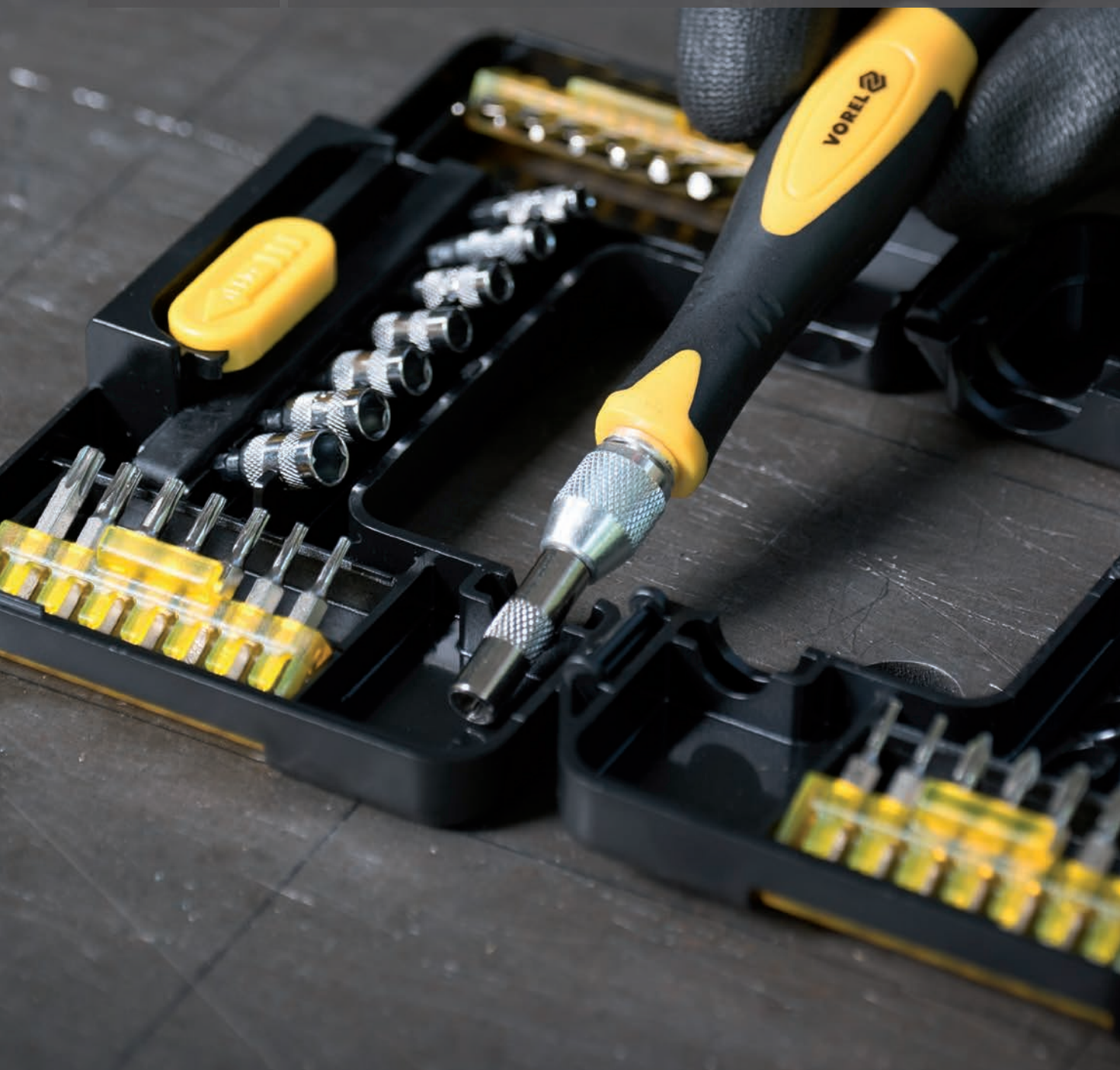

Screwdrivers, 3 colour handle Wkrętaki, trójkolorowa rączka



26-28

Slotted screwdrivers

Wkrętaki płaskie..... 26

Phillips screwdrivers

Wkrętaki krzyżakowe..... 26

Pozidrive screwdrivers

Wkrętaki „Pozidrive”..... 26

Torx screwdrivers

Wkrętaki „Torx”..... 26

Screwdriver sets

Komplety wkrętaków..... 26

Ratchet screwdrivers

Wkrętaki z grzechotką..... 28

Go-through screwdrivers Wkrętaki do pobijania



28

Slotted screwdrivers

Wkrętaki płaskie..... 28

Phillips screwdrivers

Wkrętaki krzyżakowe..... 28

Screwdrivers HI-TEC & sets Wkrętaki HI-TEC i zestawy



28-30

Slotted screwdrivers

Wkrętaki płaskie..... 28

Phillips screwdrivers

Wkrętaki krzyżakowe..... 29

Screwdriver sets

Komplety wkrętaków..... 30

Special & impact screwdrivers Wkrętaki specjalne i udarowe

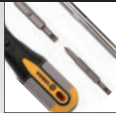

30-34

Two way screwdrivers

Wkrętaki dwustronne..... 30

Ratchet screwdriver sets with bits

Zestawy wkrętaków z grzechotką i bitami..... 31

Impact screwdrivers

Wkrętaki udarowe..... 32

Telescopic screwdrivers

Wkrętaki teleskopowe..... 33

T-bar screwdrivers

Wkrętaki T-gryf..... 34

Screwdriver sets Zestawy wkrętaków



34-35

Precision screwdrivers sets Zestawy wkrętaków precyzyjnych



35-36

Screwdriver bits Kończówki wkrętakowe

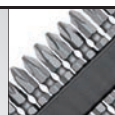

36-40

Screwdriver bit sets

Zestawy końcówek wkrętakowych..... 36

Screwdriver bit holders

Uchwyty do końcówek wkrętakowych..... 40

Nut setter sets

Zestawy nasadek magnetycznych do wkrętarek..... 40

Hex & Torx keys & sets Klucze imbusowe i zestawy



41-43

T-handle keys & sets

Klucze imbusowe typu „T” i zestawy..... 41

Hex keys

Klucze imbusowe „Hex”..... 42

Hex key sets

Zestawy kluczy imbusowych „Hex”..... 42

Torx & Torx Tamperproof key sets

Zestawy kluczy imbusowych „Torx”
i „Torx Tamperproof”..... 43

EN Slotted screwdriver
 PL Wkrętak płaski
 DE Schraubendreher schlitz
 RU Отвёртка шлицевая

CS Šroubovák
 RO Şurubelniţă
 HU Csavarhúzó
 ES Destornillador



No.	⊖ [mm]	L [mm]	Product quantity in packing / Liczba produktów w opakowaniu	
60912	2	75	12	96/384
60950	3	75	12	96/384
60951	3	100	12	96/384
60952	4	100	12	96/384
60913	4	150	12	96/384
60914	4	200	12	60/240
60915	5	38	12	60/240
60953	5	75	12	60/240
60954	5	100	12	60/240
60955	5	150	12	60/240
60916	5	200	12	36/144
60917	6	38	12	60/240
60956	6	100	12	36/144
60957	6	150	12	36/144
60958	6	200	12	36/144
60959	8	150	6	24/96
60918	8	250	6	24/96

EN Screwdriver
 PL Wkrętak
 DE Schraubendreher
 RU Отвёртка крестовая

CS Šroubovák
 RO Şurubelniţă
 HU Csavarhúzó
 ES Destornillador



No.	⊕	L [mm]	Product quantity in packing / Liczba produktów w opakowaniu	
60931	PZ0	75	12	96/384
60932	PZ0	100	12	96/384
60933	PZ1	75	12	60/240
60934	PZ1	100	12	60/240
60935	PZ1	200	12	36/144
60936	PZ2	100	12	36/144
60937	PZ2	150	12	36/144
60938	PZ2	200	12	36/144
60939	PZ3	150	6	24/96

EN Screwdriver set
 PL Komplet wkrętaków
 DE Schraubendrehersatz
 RU Набор отвёрток
 CS Zámečnické šroubováky
 RO Şurubelnițe de lăcătușerie
 HU Lakatos csavarhúzó
 ES Juego de destornilladores



No.	pcs / szt.	
60970	10	6/24

EN Phillips screwdriver
 PL Wkrętak krzyżakowy
 DE Kreuzschlitzschraubendreher
 RU Отвёртка крестовая
 CS Šroubovák křížový
 RO Şurubelniţă în cruce
 HU Csavarhúzó kereszt
 ES Destornillador cruz



No.	⊕	L [mm]	Product quantity in packing / Liczba produktów w opakowaniu	
60920	PH00	65	12	96/384
60961	PH0	75	12	96/384
60962	PH0	100	12	96/384
60921	PH1	38	12	60/240
60963	PH1	75	12	60/240
60964	PH1	100	12	60/240
60965	PH1	150	12	60/240
60922	PH1	250	12	36/144
60923	PH2	38	12	60/240
60966	PH2	100	12	36/144
60967	PH2	150	12	36/144
60968	PH2	200	12	36/144
60924	PH2	250	12	36/144
60969	PH3	150	6	24/96

EN Screwdriver
 PL Wkrętak
 DE Schraubendreher
 RU Отвёртка

CS Šroubovák
 RO Şurubelniţă
 HU Csavarhúzó
 ES Destornillador



No.	⊕	L [mm]	Product quantity in packing / Liczba produktów w opakowaniu	
60880	T5	75	12	96/384
60881	T6	75	12	96/384
60882	T7	75	12	96/384
60883	T8	75	12	96/384
60884	T9	75	12	96/384
60885	T10	100	12	60/240
60886	T15	100	12	60/240
60887	T20	100	12	60/240
60888	T25	100	12	36/144
60889	T27	100	12	36/144
60890	T30	100	12	36/144
60891	T40	100	6	24/96



⊖ 3x75, 5x100, 6x100, 6x150, 8x150 mm; CrV 6150;

⊕ PH0x75, PH1x75, PH2x100, PH2x150, PH3x150 mm; CrV 6150

EN Screwdriver set
 PL Komplet długich wkrętaków
 DE Schraubendrehersatz
 RU Набор отвёрток

CS Zámečnické šroubováky
 RO Şurubelnițe de lăcătușerie
 HU Lakatos csavarhózó
 ES Juego de destornilladores

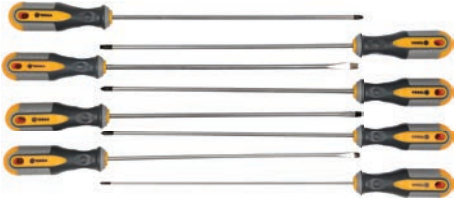
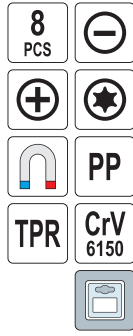

⊖ 5.5, 6.5, 8.0 mm (L=325 mm); CrV 6150;
 ⊕ PH0, PH1, PH2 (L=325 mm); CrV 6150;
 ⊗ T25, T30 (L=325 mm); CrV 6150



No.	pcs / szt.	📦
60990	8	10

EN Screwdriver set
 PL Komplet wkrętaków
 DE Schraubendrehersatz
 RU Набор отвёрток
 CS Zámečnické šroubováky
 RO Şurubelnițe de lăcătușerie
 HU Lakatos csavarhózó
 ES Juego de destornilladores

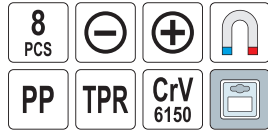

⊖ 3.0x75, 5.5x75, 6.5x38, 6.5x100 mm; CrV 6150;
 ⊕ PH0x75, PH1x75, PH2x38, PH2x100 mm; CrV 6150



No.	pcs / szt.	📦
60782	8	12/24

EN Screwdriver set
 PL Komplet wkrętaków
 DE Schraubendrehersatz
 RU Набор отвёрток

CS Zámečnické šroubováky
 RO Şurubelnițe de lăcătușerie
 HU Lakatos csavarhózó
 ES Juego de destornilladores

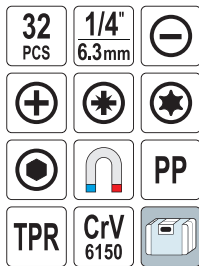

⊖ 4.0x75, 6.5x100, 8.0x150 mm; CrV 6150; ⊕ PH1x75, PH2x100 mm; CrV 6150; ⊗ PZ1x75, PZ2x100 mm; CrV 6150;
 ⊖ 2.0x50, 2.5x50, 3.0x50 mm; CrV 6150; ⊕ PH00x50, PH0x50, PH1x50 mm; CrV 6150; ⊕ 1/4" (6.3 mm); PH0, PH1, PH2 (L=25 mm); CrV 6150; ⊕ 1/4" (6.3 mm); PZ0, PZ1, PZ2 (L=25 mm); CrV 6150;
 ⊕ 1/4" (6.3 mm); T10, T15, T20, T25, T30 (L=25 mm); CrV 6150; ⊕ 1/4" (6.3 mm); 2, 2.5, 3, 4, 5, 6 mm (L=25 mm); CrV 6150; ⊕ 1/4" (6.3 mm)



No.	pcs / szt.	📦
60785	32	10

EN Screwdriver set
 PL Komplet wkrętaków
 DE Schraubendrehersatz
 RU Набор отвёрток
 CS Zámečnické šroubováky
 RO Şurubelnițe de lăcătușerie
 HU Lakatos csavarhózó
 ES Juego de destornilladores

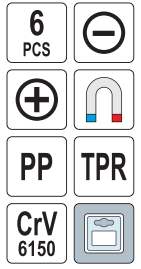

⊖ 5.5x75, 6.5x38, 6.5x100 mm; CrV 6150;
 ⊕ PH1x75, PH2x38, PH2x100 mm; CrV 6150



No.	pcs / szt.	📦
60783	6	10/20

EN Screwdriver set
 PL Komplet wkrętaków
 DE Schraubendrehersatz
 RU Набор отвёрток
 CS Zámečnické šroubováky
 RO Şurubelnițe de lăcătușerie
 HU Lakatos csavarhózó
 ES Juego de destornilladores

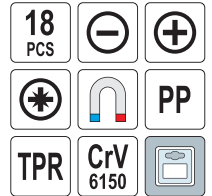

⊖ 5.5x75, 6.5x38, 6.5x100, 8.0x150 mm; CrV 6150; ⊕ PH1x75, PH2x38, PH2x100, PH3x150 mm; CrV 6150;
 ⊖ 2.5x50, 3.0x50 mm; CrV 6150; ⊕ PH00x50, PH0x50 mm; CrV 6150; ⊗ T5x50, T6x50, T7x50, T8x50, T9x50, T10x50 mm; CrV 6150



No.	pcs / szt.	📦
60781	18	10

EN Screwdriver set
 PL Komplet wkrętaków
 DE Schraubendrehersatz
 RU Набор отвёрток
 CS Zámečnické šroubováky
 RO Şurubelnițe de lăcătușerie
 HU Lakatos csavarhózó
 ES Juego de destornilladores

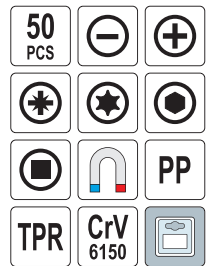

⊖ 4.0x75, 6.5x68, 6.5x100, 8.0x150 mm; CrV 6150; ⊕ PH1x75, PH2x38, PH2x100, PH3x150 mm; CrV 6150;
 ⊖ 2.0x50, 2.5x50, 3.0x50 mm; CrV 6150; ⊕ PH00x50, PH0x50 mm; CrV 6150; ⊗ T6x50, T8x50, T10x50 mm; CrV 6150; ⊕ 1/4" (6.3 mm); 3, 4, 5, 6 mm (L=25 mm); CrV 6150; ⊕ 1/4" (6.3 mm); PH0, PH1, PH2, PH3 (L=25 mm); CrV 6150; ⊕ 1/4" (6.3 mm); PZ0, PZ1, PZ2, PZ3 (L=25 mm); CrV 6150;
 ⊕ 1/4" (6.3 mm); 2, 2.5, 3, 4, 5x2, 5.5, 6 mm (L=25 mm); CrV 6150; ⊕ 1/4" (6.3 mm); T8, T10, T15, T20, T25, T27, T30, T40 (L=25 mm); CrV 6150; ⊕ 1/4" (6.3 mm); S0, S1, S2, S3 (L=25 mm); CrV 6150;
 ⊕ 1/4" (6.3 mm)



No.	pcs / szt.	📦
60780	50	6

EN Slotted screwdriver
 PL Wkrętak płaski
 DE Schraubendreher schlitz
 RU Отвёртка

CS Šroubovák
 RO Şurubelniţă
 HU Csavarhúzó
 ES Destornillador



No.	⊖ [mm]	L [mm]	Driver / Zabierak	
61110	6	100	tak	12/144
61120	6	150	nie	12/144
61140	6	200	nie	12/144
61150	6	250	nie	12/144
61160	8	150	nie	6/72

EN Phillips screwdriver
 PL Wkrętak krzyżakowy
 DE Kreuzschlitzschraubendreher
 RU Отвёртка крестовая

CS Šroubovák křížový
 RO Şurubelniţă în cruce
 HU Csavarhúzó kereszt
 ES Destornillador cruz



No.	⊕	L [mm]	
61210	PH0	63	12/240
61220	PH0	75	12/240
61230	PH0	100	12/240
61240	PH0	150	12/240

EN Phillips screwdriver
 PL Wkrętak krzyżakowy
 DE Kreuzschlitzschraubendreher
 RU Отвёртка крестовая
 CS Šroubovák křížový
 RO Şurubelniţă în cruce
 HU Csavarhúzó kereszt
 ES Destornillador cruz



No.	⊕	L [mm]	Driver / Zabierak	
61300	PH2	100	nie	12/144
61320	PH2	150	nie	12/144
61340	PH2	200	nie	12/144
61350	PH2	250	nie	12/144

EN Screwdriver
 PL Wkrętak
 DE Schraubendreher
 RU Отвёртка
 CS Šroubovák
 RO Şurubelniţă
 HU Csavarhúzó
 ES Destornillador



No.	⊕	L [mm]	
61290	PH2	38	12/288

EN Phillips screwdriver
 PL Wkrętak krzyżakowy
 DE Kreuzschlitzschraubendreher
 RU Отвёртка крестовая

CS Šroubovák křížový
 RO Şurubelniţă în cruce
 HU Csavarhúzó kereszt
 ES Destornillador cruz



No.	⊕	L [mm]	
61250	PH1	75	12/240
61260	PH1	100	12/240
61270	PH1	150	12/240
61280	PH1	200	12/240

EN Screwdriver
 PL Wkrętak
 DE Schraubendreher
 RU Отвёртка
 CS Šroubovák
 RO Şurubelniţă
 HU Csavarhúzó
 ES Destornillador



No.	⊕	L [mm]	
61360	PH3	150	6/72

- EN Screwdriver set
- PL Komplet wkręteków
- DE Schraubendrehersatz
- RU Набор отверток
- CS Zámečnické šroubováky
- RO Șurubelnițe de lăcătușerie
- HU Lakatos csavarhúzó
- ES Juego de destornilladores



No.	pcs / szt.	Box icon
61550	5	5/20

- EN Two-way screwdriver
- PL Wkrętek dwustronny
- DE Umsteckschraubendreher
- RU Отвертка двухсторонняя
- CS Dvoustranný šroubovák
- RO Șurubelniță dublu capăt
- HU Kétoldalas csavarhúzó
- ES Destornillador de dos caras



6 mm-PH2 (L=115 mm); CrV 6150



No.	pcs / szt.	Box icon
64952	6/120	

- EN Screwdriver
- PL Wkrętek
- DE Schraubendreher
- RU Отвертка
- CS Šroubovák
- RO Șurubelniță
- HU Csavarhúzó
- ES Destornillador



No.	pcs / szt.	Box icon
65041	7	25/100

- EN Two-way screwdriver
- PL Wkrętek dwustronny
- DE Umsteckschraubendreher
- RU Отвертка двухсторонняя
- CS Dvoustranný šroubovák
- RO Șurubelniță dublu capăt
- HU Kétoldalas csavarhúzó
- ES Destornillador de dos caras

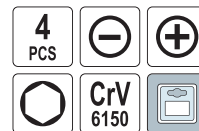

5 mm-PH1; CrV 6150;
6 mm-PH2; CrV 6150;
6-8 mm; CrV 6150



No.	pcs / szt.	Box icon
64654	4	12/72

- EN Precision screwdriver bits
- PL Zestaw końcówek śrubokrętowych
- DE Schraubendreherbitsatz
- RU Набор специальных бит
- CS Sada bitov
- RO Truse bit
- HU Bitkészlet
- ES Juego de llaves especiales

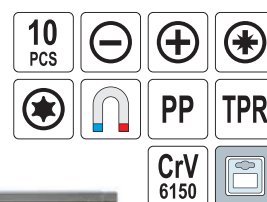

5-6 mm (L=150 mm); CrV 6150; PH1-PH2 (L=150 mm); CrV 6150; PZ1-PZ2 (L=150 mm); CrV 6150; T20-T25 (L=150 mm); CrV 6150; 5-6 mm (L=150 mm); CrV 6150



No.	pcs / szt.	Box icon
64960	6	12/48

- EN Precision screwdriver bits
- PL Zestaw końcówek śrubokrętowych
- DE Schraubendreherbitsatz
- RU Набор специальных бит
- CS Sada bitov
- RO Truse bit
- HU Bitkészlet
- ES Juego de llaves especiales

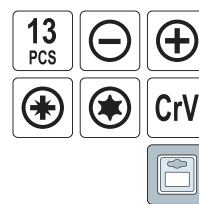

1/4" (6.3 mm): 4, 5, 6 mm (L=25 mm); CrV;
1/4" (6.3 mm): PH1, PH2, PH3 (L=25 mm); CrV;
1/4" (6.3 mm): PZ1, PZ2, PZ3 (L=25 mm); CrV;
1/4" (6.3 mm): T10, T15, T20 (L=25 mm); CrV



No.	pcs / szt.	Box icon
65035	13	6/24

EN Ratchet screwdriver set with bits
 PL Zestaw wkrętak z grzechotką i bitami
 DE Schraubendreher mit Ratche
 RU Отвёртка реверсивная с набором бит
 CS Šroubovák z řehačkou
 RO Şurubelniţă cu clichet
 HU Racsfnis csavarbehajtó
 ES Juego con destornillador y carraca

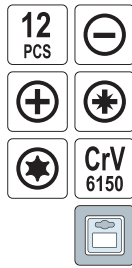

□ 1/4" (6.3 mm): 3.5, 4, 5.5 mm (L=25 mm);
 ⊕ 1/4" (6.3 mm): PH0, PH1, PH2 (L=25 mm);
 ⊕ 1/4" (6.3 mm): PZ0, PZ1, PZ2 (L=25 mm);
 ⊕ 1/4" (6.3 mm): T20, T25 (L=25 mm)



No.	pcs / szt.	
64658	12	12/72

EN Precision screwdriver bits
 PL Zestaw końcówek śrubokrętowych
 DE Schraubendreherbitsatz
 RU Набор специальных бит
 CS Sada bitov
 RO Truse bit
 HU Bitkészlet
 ES Juego de llaves especiales

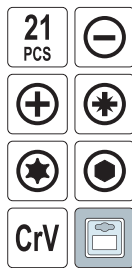

□ 1/4" (6.3 mm): (L=60 mm); □ 1/4" (6.3 mm): 4, 5, 6, 7 mm (L=25 mm); CrV;
 ⊕ 1/4" (6.3 mm): PH1, PH2, PH3 (L=25 mm); CrV; ⊕ 1/4" (6.3 mm): PZ1, PZ2, PZ3 (L=25 mm); CrV;
 ⊕ 1/4" (6.3 mm): T10, T15, T20, T25, T27, T30 (L=25 mm); CrV; ○ 1/4" (6.3 mm): 3, 4, 5, 6 mm (L=25 mm); CrV



No.	pcs / szt.	
65015	21	9/36

EN Ratchet screwdriver set with bits
 PL Zestaw wkrętak z grzechotką i bitami
 DE Schraubendreher mit Ratche
 RU Отвёртка реверсивная с набором бит
 CS Šroubovák z řehačkou
 RO Şurubelniţă cu clichet
 HU Racsfnis csavarbehajtó
 ES Juego con destornillador y carraca



□ 1/4" (6.3 mm): 4, 5, 6, 7, 6.9, 10, 11, 12 mm; □ 1/4" (6.3 mm): (L=25 mm); CrV 6150; □ 1/4" (6.3 mm): 4, 5, 6 mm (L=25 mm); CrV 6150; ⊕ 1/4" (6.3 mm): PH0, PH1, PH2, PH3 (L=25 mm); CrV 6150;
 ⊕ 1/4" (6.3 mm): PZ0, PZ1, PZ2, PZ3 (L=25 mm); CrV 6150; ⊕ 1/4" (6.3 mm): T10, T15, T20 (L=25 mm); CrV 6150



No.	pcs / szt.	
65105	25	6/36

EN Ratchet screwdriver set with bits
 PL Zestaw wkrętak z grzechotką i bitami
 DE Schraubendreher mit Ratche
 RU Отвёртка реверсивная с набором бит
 CS Šroubovák z řehačkou
 RO Şurubelniţă cu clichet
 HU Racsfnis csavarbehajtó
 ES Juego con destornillador y carraca

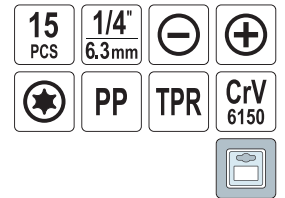

□ 1/4" (6.5 mm): 6, 7, 8, 9, 10 mm;
 □ 1/4" (6.3 mm): (L=25 mm); CrV 6150;
 □ 1/4" (6.3 mm): 3, 4, 6 mm (L=25 mm); CrV 6150;
 ⊕ 1/4" (6.3 mm): PH0, PH1, PH2 (L=25 mm); CrV 6150;
 ⊕ 1/4" (6.3 mm): T15, T20 (L=25 mm); CrV 6150



No.	pcs / szt.	
65034	15	6/24

EN Ratchet screwdriver set with bits
 PL Zestaw wkrętak z grzechotką i bitami
 DE Schraubendreher mit Ratche
 RU Отвёртка реверсивная с набором бит
 CS Šroubovák z řehačkou
 RO Şurubelniţă cu clichet
 HU Racsfnis csavarbehajtó
 ES Juego con destornillador y carraca

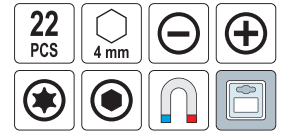

□ 1.5, 2.0, 2.5, 3.0 mm; CrV; ⊕ PH0000, PH00, PH0, PH1; CrV; ⊕ T6, T7, T8, T9, T10, T15, T20; CrV; ○ 1.5, 2.0, 2.5, 3.0, 4.0 mm; CrV; □ 115 mm; CrV



No.	pcs / szt.	
64402	22	6/36

EN Ratchet screwdriver set with bits
 PL Wkrętak z grzechotką i wymiennymi końcówkami
 DE Schraubendreher mit Ratche
 RU Отвёртки с набором бит
 CS Šroubovák z řehačkou
 RO Şurubelniţă cu clichet
 HU Racsfnis csavarbehajtó
 ES Juego con destornillador y carraca

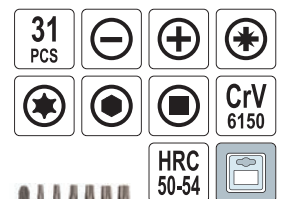

□ 1/4" (6.3 mm): 3, 3.5, 4, 5, 5.5, 6 mm (L=25 mm); ⊕ 1/4" (6.3 mm): PH0, PH1, PH2, PH3 (L=25 mm); ⊕ 1/4" (6.3 mm): PZ0, PZ1, PZ2, PZ3 (L=25 mm); ⊕ 1/4" (6.3 mm): T10, T15, T20, T25, T27, T30 (L=25 mm); ○ 1/4" (6.3 mm): 2, 2.5, 3, 4, 5, 6 mm (L=25 mm); □ 1/4" (6.3 mm): S0, S1 (L=25 mm); ⊕ 2.0x50 mm; ⊕ PH00 x 50 mm



No.	pcs / szt.	
64655	31	6/36

EN Ratchet screwdriver set with bits
 PL Zestaw wkrętek z grzechotką i bitami
 DE Schraubendreher mit Ratche
 RU Отвёртка реверсивная с набором бит
 CS Šroubovák z řehtačkou
 RO Şurubelniţă cu clichet
 HU Racsznis csavarbehajtó
 ES Juego con destornillador y carraca

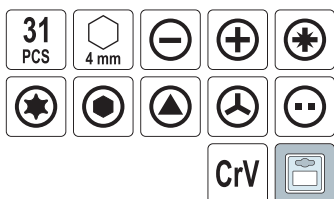

□ 1.0, 1.5, 2.0, 2.5, 3.0 mm; CrV; ⚙ PH000, PH00, PH0, PH1, PH2; CrV; ⚙ PZ0, PZ1; CrV; ⚙ T4, T5, T6, T7, T8, T10; CrV; ○ 0.7, 0.9, 1.3, 1.5, 2.0, 3.0 mm; CrV; △ 3.0 mm; CrV; ▽ 2.6 mm; CrV; ▭ 115 mm; CrV



No.	pcs / szt.	📦
65025	31	6/24

EN Ratchet screwdriver set with bits
 PL Zestaw wkrętek z grzechotką i bitami
 DE Schraubendreher mit Ratche
 RU Отвёртка реверсивная с набором бит
 CS Šroubovák z řehtačkou
 RO Şurubelniţă cu clichet
 HU Racsznis csavarbehajtó
 ES Juego con destornillador y carraca

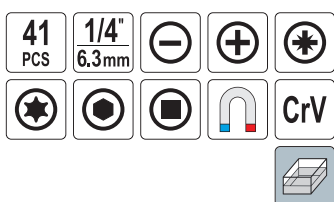

⌄ 1/4 (6.3 mm): 5, 6, 7, 8, 9, 10 mm (L=20 mm); CrV; ⌄ 3.0, 4.0, 5.0, 6.0 mm, 1/8" (3.2 mm), 5/32" (4.0 mm), 3/16" (4.8 mm), 1/4" (6.3 mm); CrV; ⚙ PH0, PH1, PH2, PH3; CrV; ⚙ PZ0, PZ1, PZ2, PZ3; CrV; ⚙ T15, T20, T25, T30; CrV; ○ 3.0, 4.0, 5.0, 6.0 mm, 1/8" (3.2 mm), 5/32" (4.0 mm), 3/16" (4.8 mm), 1/4" (6.3 mm); CrV; □ S0, S1, S2, S3 mm; CrV; ⚙ 1/4" (6.3 mm); CrV; ▭ 1/4" (6.3 mm); (L=60 mm); CrV



No.	pcs / szt.	📦
64385	41	6/24

EN Impact screwdriver
 PL Wkrętkak udarowy
 DE Schlagschrauber
 RU Отвёртка ударная
 CS Narazový šroubovák kovový
 RO Şurubelniţă metalică cu percutor
 HU Kézi ütvecsavarhúzó
 ES Destornillador de percusión

No.	pcs / szt.	📦
65120	5	25

EN Ratchet screwdriver set with bits
 PL Wkrętkak z grzechotką i wymiennymi końcówkami
 DE Schraubendreher mit Ratche
 RU Отвёртки с набором бит
 CS Šroubovák z řehtačkou
 RO Şurubelniţă cu clichet
 HU Racsznis csavarbehajtó
 ES Juego con destornillador y carraca

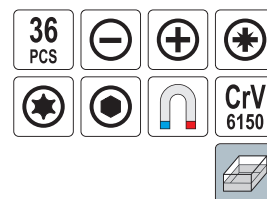

⌄ 1/4" (6.3 mm): 4, 4.5, 5, 6, 7, 8, 9, 10, 11, 12, 13 mm; ⌄ 1/4 (6.3 mm): 3, 3.5, 4, 5.5 mm (L=25 mm); ⚙ 1/4" (6.3 mm): PH0, PH1, PH2, PH3 (L=25 mm); ⚙ 1/4" (6.3 mm): PZ0, PZ1, PZ2, PZ3 (L=25 mm); ⚙ 1/4" (6.3 mm): T10, T15, T20, T25, T27, T30 (L=25 mm); ○ 1/4" (6.3 mm): 3, 4 mm (L=25 mm); ▭ 50 mm



No.	pcs / szt.	📦
64660	36	6/24

EN Ratchet screwdriver set with bits
 PL Zestaw wkrętek z grzechotką i bitami
 DE Schraubendreher mit Ratche
 RU Отвёртка реверсивная с набором бит
 CS Šroubovák z řehtačkou
 RO Şurubelniţă cu clichet
 HU Racsznis csavarbehajtó
 ES Juego con destornillador y carraca

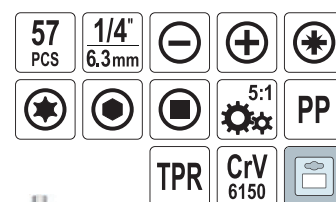

⌄ 1/4" (6.3 mm): 3 x2, 4 x2, 5 x3, 6 x5, 7 x2 mm (L=25 mm); CrV 6150; ⚙ 1/4" (6.3 mm): PH0 x2, PH1 x2, PH2 x7, PH3 x3 (L=25 mm); CrV 6150; ⚙ 1/4" (6.3 mm): PZ0, PZ1 x2, PZ2 x2, PZ3 x2 (L=25 mm); CrV 6150; ⚙ 1/4" (6.3 mm): T10, T15, T20, T25 x2, T27, T30 (L=25 mm); CrV 6150; ○ 1/4" (6.3 mm): 3, 4 x2, 5 x2, 6 x2 mm (L=25 mm); CrV 6150; □ 1/4" (6.3 mm): S0, S1 x2, S2 x2, S3 x2 (L=25 mm); CrV 6150



No.	pcs / szt.	📦
65033	57	6/12



EN Ratchet screwdriver set with bits
 PL Zestaw wkrętak z grzechotką i bitami
 DE Schraubendreher mit Rathe
 RU Отвёртка реверсивная с набором бит
 CS Šroubovák z řehotkou
 RO Şurubelniţă cu clichet
 HU Racsnis csavarbehajtó
 ES Juego con destornillador y carraca

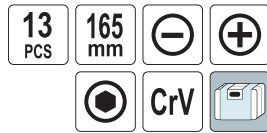

- □ 5/16" (7.9mm) x 1/2" (12.7mm);
- 5, 6, 8, 9 mm (L=35 mm);
- ⊕ PH1, PH2, PH3, PH4 (L=35 mm);
- □ 4, 5, 6, 8 mm (L=35 mm)



No.	pcs / szt.	□
65123	13	20

EN Telescopic screwdriver, magnetic
 PL Wkrętak magnetyczny, teleskopowy
 DE Schraubendreher
 RU Отвёртка магнитная с битами
 CS Magnetický řoubavak -teleskop
 RO Şurubelniţă telescopică cu magnet
 HU Mágneses csavarbehajtó-teleszkop
 ES Destornillador magnético-telescop



No.	pcs / szt.	□
65045	7	25/100

EN Screwdriver with magnetic telescopic pick-up tool
 PL Wkrętak z teleskopowym chwytakiem magnetycznym
 DE Schraubendreher mit auschiebbarem magnetischem Halter
 RU Отвёртка магнитная с битами
 CS Magnetický řoubavak-teleskop
 RO Şurubelniţă cu magnet-teleskop
 HU Mágneses csavarbehajtó-teleszkop
 ES Destornillador magnético-telescop



No.	pcs / szt.	□
65046	13	5/50

EN Impact screwdriver
 PL Wkrętak udarowy
 DE Schlagschrauber
 RU Отвёртка ударная
 CS Narazový šroubovák kovový
 RO Şurubelniţă metalică cu percutor
 HU Kézi ütvecsavarhúzó
 ES Destornillador de percusión

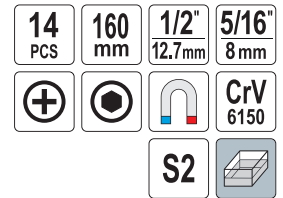

- □ 5/16" (7.9mm) x 1/2" (12.7mm);
- 4, 5, 6, 8, 9 mm (L=35 mm); S2;
- ⊕ PH1, PH2, PH3 (L=35 mm); S2;
- □ 4, 5, 6, 8 mm (L=35 mm)



No.	pcs / szt.	□
65124	14	20

EN Screwdriver with magnetic telescopic pick-up tool
 PL Wkrętak z teleskopowym chwytakiem magnetycznym
 DE Schraubendreher mit auschiebbarem magnetischem Halter
 RU Отвёртка магнитная с битами
 CS Magnetický řoubavak-teleskop
 RO Şurubelniţă cu magnet-teleskop
 HU Mágneses csavarbehajtó-teleszkop
 ES Destornillador magnético-telescop

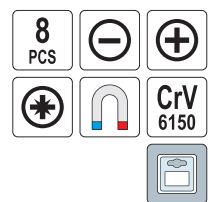

- 1/4" (6.3 mm); 3, 4, 5.5 mm (L=25 mm);
- ⊕ 1/4" (6.3 mm); PH1, PH2 (L=25 mm);
- ⊕ 1/4" (6.3 mm); PZ1, PZ2 (L=25 mm)



No.	pcs / szt.	□
64650	8	12/72

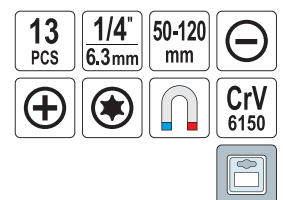

- 4, 5, 6, 7 mm (L= 25 mm); CrV;
- ⊕ PH1, PH2, PH3 (L= 25 mm); CrV;
- ⊕ T10, T15, T20, T25, T30 (L= 25 mm); CrV;
- 50-120 mm

3

EN T-bar screwdriver
 PL Wkrętak T-gryf
 DE T-griff Schraubendrehersatz
 RU Отвёртка с T-образной ручкой и насадками
 CS Šroubovák T-gryf
 RO Set surubelnita tip „T”
 HU Csavarbehajtó, T-gryf
 ES Destornillador T-grifo

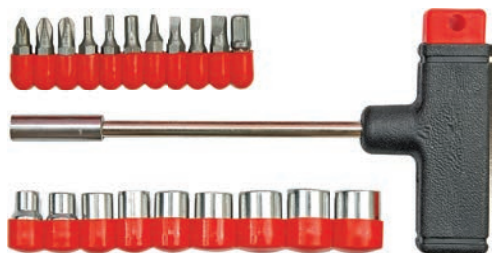

No.	pcs / szt.	Icon
65100	21	10/80

EN Screwdriver set
 PL Komplet wkrętaków
 DE Schraubendrehersatz
 RU Набор отвёрток
 CS Zámečnické šroubováky
 RO Șurubelnițe de lăcătușerie
 HU Lakatos csavarhózó
 ES Juego de destornilladores



No.	pcs / szt.	Icon
64060	6	20/60

EN Screwdriver set
 PL Komplet wkrętaków
 DE Schraubendrehersatz
 RU Набор отвёрток
 CS Zámečnické šroubováky
 RO Șurubelnițe de lăcătușerie
 HU Lakatos csavarhózó
 ES Juego de destornilladores



No.	pcs / szt.	Icon
64070	7	20/80

EN T-bar screwdriver
 PL Wkrętak T-gryf
 DE T-griff Schraubendrehersatz
 RU Отвёртка с T-образной ручкой и насадками
 CS Šroubovák T-gryf
 RO Set surubelnita tip „T”
 HU Csavarbehajtó, T-gryf
 ES Destornillador T-grifo

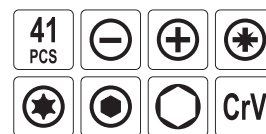

□ 1/4" (6.3 mm): 4, 5, 6, 7 mm (L=25 mm); ⚙ 1/4" (6.3 mm): PH1, PH2, PH3 (L=25 mm);
 ⚙ 1/4" (6.3 mm): T10, T15, T20, T25, T30, T40 (L=25 mm); ⚙ 1/4" (6.3 mm): PZ1, PZ2, PZ3
 (L=25 mm); ○ 1/4" (6.3 mm): 4, 5, 6 mm (L=25 mm); ⚙ 1/4" (6.3 mm): 5, 6, 7, 8, 9, 10, 11, 12, 13 mm; CrV;
 ⚙ 1/4" (6.3 mm): 3/16" (4.8 mm), 7/32" (5.6 mm), 1/4" (6.3 mm) 9/32" (7.1 mm), 5/16" (7.9 mm), 11/32" (8.7 mm), 3/8"
 (9.5 mm) 7/16" (11.1 mm), 1/2" (12.7 mm); CrV; ⚙ 1/4" (6.3 mm) x 6 mm; ⚙ 1/4" (6.3 mm)



No.	pcs / szt.	Icon
65150	41	24

EN Screwdriver set
 PL Komplet wkrętaków
 DE Schraubendrehersatz
 RU Набор отвёрток
 CS Zámečnické šroubováky
 RO Șurubelnițe de lăcătușerie
 HU Lakatos csavarhózó
 ES Juego de destornilladores



No.	pcs / szt.	Icon
64050	6	20/80

EN Screwdriver set
 PL Komplet wkrętaków
 DE Schraubendrehersatz
 RU Набор отвёрток
 CS Zámečnické šroubováky
 RO Șurubelnițe de lăcătușerie
 HU Lakatos csavarhózó
 ES Juego de destornilladores



No.	pcs / szt.	Icon
64090	6	10/60

EN Ratchet screwdriver set with bits
 PL Zestaw wkrętak z grzechotką i bitami
 DE Schraubendreher mit Ratche
 RU Отвёртка реверсивная с набором бит
 CS Šroubovák z fehtačkou
 RO Şurubelniţă cu clichet
 HU Racsnis csavarbehajtó
 ES Juego con destornillador y carraca

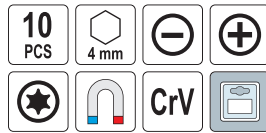

□ 1.0, 1.5, 2.0 mm; CrV;
 ⊕ PH00, PH0, PH1; CrV;
 ⊕ T6, T7, T8; CrV



No.	pcs / szt.	☐
64400	10	8/144

EN Ratchet screwdriver set with bits
 PL Zestaw wkrętak z grzechotką i bitami
 DE Schraubendreher mit Ratche
 RU Отвёртка реверсивная с набором бит
 CS Šroubovák z fehtačkou
 RO Şurubelniţă cu clichet
 HU Racsnis csavarbehajtó
 ES Juego con destornillador y carraca

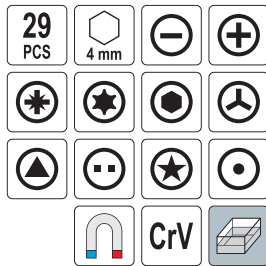

□ 0.7, 1.0, 1.2, 1.5, 1.8 mm; CrV; ⊕ PH000, PH00, PH0, PH1; CrV; ⊕ PZ000, PZ00, PZ0, PZ1; CrV; ○ 0.7, 0.9, 1.3, 1.5, 2.0 mm; CrV; ⊕ T4, T5, T6, T7, T8; CrV; ⊕ 3.0 mm; CrV; △ 3.0 mm; CrV; ▽ 2.6 mm; CrV; ☆ 2.0 mm; CrV; ○ 1.0 mm; CrV



No.	pcs / szt.	☐
64401	29	12/48

EN Precision screwdriver set
 PL Zestaw wkrętaków precyzyjnych
 DE Präzisions-Feinmechanikersatz
 RU Набор прецизионных отверток

CS Šroubováký sada pro jemnou mechaniku
 RO Set surubelnite
 HU Órás csavarhúzó készlet
 ES Destornilladores precisos

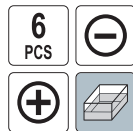

⊖ 1.4, 2.0, 2.4, 3.0 mm;
 ⊕ PH0, PH1

No.	pcs / szt.	☐
64310	6	20/100

EN Precision screwdriver bits and holder
 PL Zestaw końcówek śrubokrętowych z uchwytem
 DE Schraubendreherbitsatz mit Bithalter
 RU Отвёртка с набором специальных бит
 CS Sada bitů s držákem
 RO Truse bit + capete şurubel niţă
 HU Csavarhúzó bit készlet
 ES Juego de destornillador con puntas

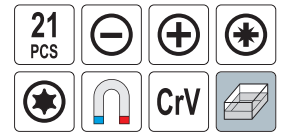

No.	pcs / szt.	☐
64370	21	10/60

EN Precision screwdriver bits and holder
 PL Zestaw końcówek śrubokrętowych z uchwytem
 DE Schraubendreherbitsatz mit Bithalter
 RU Отвёртка с набором специальных бит
 CS Sada bitů s držákem
 RO Truse bit + capete şurubel niţă
 HU Csavarhúzó bit készlet
 ES Juego de destornillador con puntas

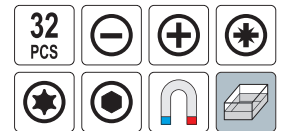

□ 1/4" (6.3 mm): 1.0, 1.5, 2.0, 2.5, 3.0, 3.5, 4.0 mm;
 ⊕ 1/4" (6.3 mm): PH000, PH00, PH0, PH1;
 ⊕ 1/4" (6.3 mm): PZ0, PZ1;
 ⊕ 1/4" (6.3 mm): T4, T5, T6, T7, T8, T9, T10, T15, T20;
 ○ 1/4" (6.3 mm): 0.7, 0.9, 1.3, 1.5, 2.0, 2.5, 3.0, 4.0 mm



No.	pcs / szt.	☐
64371	32	10/20

EN Precision screwdriver set
 PL Zestaw wkrętaków precyzyjnych
 DE Präzisions-Feinmechanikersatz
 RU Набор прецизионных отверток

CS Šroubováký sada pro jemnou mechaniku
 RO Set surubelnite
 HU Órás csavarhúzó készlet
 ES Destornilladores precisos

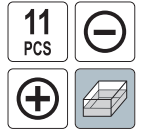

⊖ 0.9, 1.2, 1.4, 1.8, 2.4, 3.0 mm;
 ⊕ PH00, PH0, PH1

No.	pcs / szt.	☐
64330	11	25/100

EN Precision screwdriver and hook set
 PL Zestaw precyzyjnych wkręteków i haczyków
 DE Präzisions-Schraubendreher- und Haken-Satz
 RU Набор точных отверток и крючков
 CS Sada přesných šroubováků a háčků
 RO Set surubelnite de precizie
 HU Precíziós csavarhúzó és kampó készlet
 ES Set de destornilladores precisos y ganchos

12 PCS 165 mm

⊖ ⊕

★ CrV

📦



⊖ 2.5, 3.5 mm; ⊕ PH00, PH0; ★ T6, T7, T8, T10; 📏 45°, 90°, 135°, 180°



No.	pcs / szt.	📦
64555	12	10/40

EN Precision screwdriver bits and holder
 PL Zestaw końcówek śrubokrętowych z uchwytem
 DE Schraubendreherbitsatz mit Bithalter
 RU Отвертка с набором специальных бит
 CS Sada bitů s držákem
 RO Truse bit + capete șurubel niță
 HU Csavarhúzó bit készlet
 ES Juego de destornillador con puntas

32 PCS

⊖ ⊕

★

⬆ ⬇ ⬅

★

⊙ CrV 6150

📦



⊖ 1/16" (1.6 mm), 5/64" (2.0 mm), 3/32" (2.4 mm), 1/8" (3.2 mm), 9/64" (3.6 mm), 5/32" (4.0 mm); ⊕ PH000, PH00, PH0, PH1, PH2; ○ 0.035" (0.9 mm), 1/16" (1.6 mm), 0.05" (1.8 mm), 5/64" (2.0 mm), 3/32" (2.4 mm), 1/8" (3.2 mm), 5/32" (4.0 mm); ⚙️ T4, T5, T6, T7, T8, T10, T15, T20; ☆ 5/64" (2.0 mm); ◊ 0.035" (0.9 mm); △ 1/8" (3.2 mm); ⚡ 1/8" (3.2 mm); ⚡ 7/64" (2.8 mm)



No.	pcs / szt.	📦
64396	32	10/50

EN Precision screwdriver set
 PL Wkrętki precyzyjne
 DE Präzisions-Schraubendrehersatz
 RU Набор отверток для точных работ
 CS Precizní šroubováky
 RO Șurubelnite precise
 HU Precíziós csavarhúzó
 ES Destornilladores precisos

6 PCS

📏

CrV

📦



No.	Tip size / Rozmiar grotu	pcs / szt.	📦
64553	1.4, 2.4, 3.0, PH00, PH0, PH1	6	10/60
64554	T5, T6, T7, T8, T9, T10	6	10/60

EN Precision screwdriver bits and holder
 PL Zestaw końcówek śrubokrętowych z uchwytem
 DE Schraubendreherbitsatz mit Bithalter
 RU Отвертка с набором специальных бит
 CS Sada bitů s držákem
 RO Truse bit + capete șurubel niță
 HU Csavarhúzó bit készlet
 ES Juego de destornillador con puntas

22 PCS

⊖ ⊕

★

⬆ ⬇ ⬅

★

⊙ CrV 6150

📦



⊖ 1/16" (1.6 mm), 5/64" (2.0 mm), 3/32" (2.4 mm), 1/8" (3.2 mm), 5/32" (4.0 mm); ⊕ PH000, PH00, PH0, PH1; ⚙️ T5, T6, T7, T8, T9, T10, T15, T20; △ 3.0 mm; ⚡ 3.0 mm; ⚡ 2.6 mm; 📏



No.	pcs / szt.	📦
64395	22	10/50

EN Mobile phone repair tool set
 PL Zestaw do naprawy telefonów komórkowych
 DE Mobiltelefon Reparatur Satz
 RU Набор инструмента для ремонта мобильных телефонов
 CS Nástroje na opravu mobilních telefonů
 RO Set surubelnite service telefoane mobile
 HU Mobiltelefon-javítás szerszámkészlet
 ES Herramientas de la reparación del teléfono móvil fijadas

32 PCS 4 mm

⊖ ⊕

★

⬆ ⬇ ⬅

★

⊙ CrV

📦



⊖ 1.0, 2.0 mm; CrV; ⊕ PH000, PH00, PH0, PH1; CrV; ⚙️ T2, T3, T4, T5, T6, T8, T10; CrV; ⚙️ T7, CrV; ◊ 1.5, 2.0 mm; CrV; ⚡ Y000, Y00, Y0, CrV; ☆ 0.8 x2, 1.2, 1.5 mm; CrV; △ 3.0 mm; CrV; 📏 4x75 mm; CrV



No.	pcs / szt.	📦
64384	32	6/48

EN Screwdriver bit set
 PL Zestaw końcówek śrubokrętowych
 DE Schraubendreherbitsatz
 RU Набор бит крестовых
 CS Sada bitů
 RO Truse bit
 HU Bitkészlet
 ES Puntas de destornilladora

3 PCS

⊖ ⊕

CrV 6150

📦



No.	⊖ [mm]	L [mm]	📏	Max. torque / Maks. moment obrotowy [Nm]	pcs / szt.	📦
65480	4	25	1/4" (6.3 mm)	1.4	3	144/288
65481	5	25	1/4" (6.3 mm)	3.2	3	144/288
65482	6	25	1/4" (6.3 mm)	5.8	3	144/288
65483	8	25	1/4" (6.3 mm)	11.5	3	144/288

EN Screwdriver bit set
 PL Zestaw końcówek śrubokrętowych
 DE Schraubendreherbitsatz
 RU Набор бит крестовых
 CS Sada bitů
 RO Truse bit
 HU Bitkészlet
 ES Puntas de destornilladora



STHOR

No.	⊕	L [mm]	⬡	Max. torque / Maks. moment obrotowy [Nm]	pcs / szt.	📦
65451	PH0	25	1/4" (6.3 mm)	1.0	3	144/288
65452	PH1	25	1/4" (6.3 mm)	3.5	3	144/288
65453	PH2	25	1/4" (6.3 mm)	8.2	3	144/288
65454	PH3	25	1/4" (6.3 mm)	19.5	3	144/288

EN Screwdriver bit set
 PL Zestaw końcówek śrubokrętowych
 DE Schraubendreherbitsatz
 RU Набор бит крестовых
 CS Sada bitů
 RO Truse bit
 HU Bitkészlet
 ES Puntas de destornilladora



STHOR

No.	⊕	L [mm]	⬡	Max. torque / Maks. moment obrotowy [Nm]	pcs / szt.	📦
65470	PZ1	25	1/4" (6.3 mm)	3.5	3	144/288
65471	PZ2	25	1/4" (6.3 mm)	8.2	3	144/288
65472	PZ3	25	1/4" (6.3 mm)	19.5	3	144/288

EN Screwdriver bit set
 PL Zestaw końcówek śrubokrętowych
 DE Schraubendreherbitsatz
 RU Набор бит крестовых

CS Sada bitů
 RO Truse bit
 HU Bitkészlet
 ES Puntas de destornilladora



STHOR

No.	⊕	L [mm]	⬡	Max. torque / Maks. moment obrotowy [Nm]	pcs / szt.	📦
65456	PH1	50	1/4" (6.3 mm)	3.5	3	144/288
65457	PH2	50	1/4" (6.3 mm)	8.2	3	144/288
65458	PH3	50	1/4" (6.3 mm)	19.5	3	144/288

EN Screwdriver bit set
 PL Zestaw końcówek śrubokrętowych
 DE Schraubendreherbitsatz
 RU Набор битов
 CS Sada bitů
 RO Truse bit
 HU Bitkészlet
 ES Puntas de destornilladora



STHOR

No.	⊕	L [mm]	⬡	Max. torque / Maks. moment obrotowy [Nm]	pcs / szt.	📦
65461	PH1, PH2, PH3	25	1/4" (6.3 mm)	3.5, 8.2, 19.5	3	144/288

EN Screwdriver bit set
 PL Zestaw końcówek śrubokrętowych
 DE Schraubendreherbitsatz
 RU Набор бит крестовых

CS Sada bitů
 RO Truse bit
 HU Bitkészlet
 ES Puntas de destornilladora



STHOR

No.	⊙ [mm]	L [mm]	⬡	Max. torque / Maks. moment obrotowy [Nm]	pcs / szt.	📦
65501	3	25	1/4" (6.3 mm)	6.6	3	144/288
65502	4	25	1/4" (6.3 mm)	16.0	3	144/288
65503	5	25	1/4" (6.3 mm)	30.0	3	144/288
65504	6	25	1/4" (6.3 mm)	52.0	3	144/288
65505	8	25	1/4" (6.3 mm)	55.0	3	144/288

EN Screwdriver bit set
 PL Zestaw końcówek śrubokrętowych
 DE Schraubendreherbitsatz
 RU Набор бит крестовых

CS Sada bitů
 RO Truse bit
 HU Bitkészlet
 ES Puntas de destornilladora



STHOR

No.	⊕	L [mm]	⬡	Max. torque / Maks. moment obrotowy [Nm]	pcs / szt.	📦
65475	PZ1	50	1/4" (6.3 mm)	3.5	3	144/288
65476	PZ2	50	1/4" (6.3 mm)	8.2	3	144/288
65477	PZ3	50	1/4" (6.3 mm)	19.5	3	144/288

EN Screwdriver bit set
 PL Zestaw końcówek śrubokrętowych
 DE Schraubendreherbitsatz
 RU Набор битов
 CS Sada bitů
 RO Truse bit
 HU Bitkészlet
 ES Puntas de destornilladora

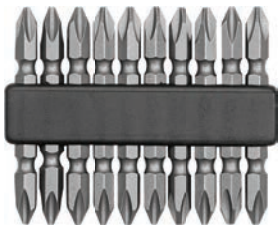

No.	+	L [mm]	pcs / szt.	📦
65700	PH2	60	10	25/100

EN Screwdriver bit set
 PL Zestaw końcówek śrubokrętowych
 DE Schraubendreherbitsatz
 RU Набор битов
 CS Sada bitů
 RO Truse bit
 HU Bitkészlet
 ES Puntas de destornilladora



1/4" (6.3 mm): 3, 4, 5, 5.5, 6, 7 mm (L=25 mm); CrV; 1/4" (6.3 mm): PH0, PH1 x2, PH2 x2, PH3 (L=25 mm); CrV; 1/4" (6.3 mm): PZ0, PZ1 x2, PZ2 x2, PZ3 (L=25 mm); CrV; 1/4" (6.3 mm): T10, T15, T20, T25, T27, T30 (L=25 mm); CrV; 1/4" (6.3 mm): 2, 3, 4, 5, 5.5, 6 mm (L=25 mm); CrV; 1/4" (6.3 mm); (L=60 mm); CrV



No.	pcs / szt.	📦
66302	31	10/30

EN Screwdriver bit set
 PL Zestaw końcówek śrubokrętowych
 DE Schraubendreherbitsatz
 RU Набор битов
 CS Sada bitů
 RO Truse bit
 HU Bitkészlet
 ES Puntas de destornilladora

1/4" (6.3 mm): 3, 4, 5, 5.5, 6, 7 mm (L=25 mm); 4, 6 mm (L=50 mm); CrV;
 1/4" (6.3 mm): PH0, PH1 x2, PH2 x5, PH3 (L=25 mm); PH1, PH2, PH3 (L=50 mm); CrV;
 1/4" (6.3 mm): PZ0, PZ1 x2, PZ2 x5, PZ3 (L=25 mm), PZ1, PZ2, PZ3 (L=50 mm); CrV;
 1/4" (6.3 mm): T10, T15, T20, T25, T27, T30, T40 (L=25 mm); T15, T20, T25 (L=50 mm); CrV;
 1/4" (6.3 mm): 2, 2.5, 3, 4, 5, 5.5, 6 mm (L=25 mm); 4, 5, 6 mm (L=50 mm); CrV;
 1/4" (6.3 mm): S0, S1, S2, S3 (L=25 mm); CrV



No.	pcs / szt.	📦
66310	56	8/16

EN Screwdriver bit set
 PL Końcówki śrubokrętowe do gipsów
 DE Schraubendreherbitsatz
 RU Насадки для быстрого завинчивания саморезов по гипсокартону
 CS Koncovky šroubovákové na sádku
 RO Capete pt. ghips pt. șrubelniță
 HU Csavarhúzóvégek gipszhez
 ES Puntas con limitador



1/4" (6.3 mm): PH2 (L=25 mm)



No.	pcs / szt.	📦
65800	2	12/144

EN Screwdriver bit set
 PL Zestaw końcówek śrubokrętowych
 DE Schraubendreherbitsatz
 RU Набор битов
 CS Sada bitů
 RO Truse bit
 HU Bitkészlet
 ES Puntas de destornilladora

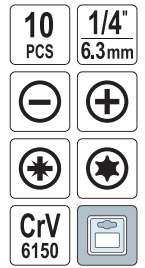

1/4" (6.3 mm): 5, 6 mm (L=25 mm); CrV; 1/4" (6.3 mm): PH0, PH1, PH2 (L=25 mm); CrV;
 1/4" (6.3 mm): PZ1, PZ2 (L=25 mm); CrV; 1/4" (6.3 mm): T15, T20 (L=25 mm); CrV;
 1/4" (6.3 mm); (L=60 mm); CrV



No.	pcs / szt.	📦
65705	10	5/80

EN Screwdriver bit set
 PL Zestaw końcówek śrubokrętowych
 DE Schraubendreherbitsatz
 RU Набор битов
 CS Sada bitů
 RO Truse bit
 HU Bitkészlet
 ES Puntas de destornilladora

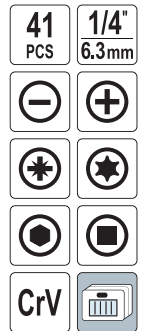

1/4" (6.3 mm): 3, 4, 5, 5.5, 6, 7 mm (L=25 mm); CrV; 1/4" (6.3 mm): PH0, PH1 x2, PH2 x4, PH3 (L=25 mm); CrV; 1/4" (6.3 mm): PZ0, PZ1 x2, PZ2 x4, PZ3 (L=25 mm); CrV; 1/4" (6.3 mm): T10, T15, T20, T25, T27, T30, T40 (L=25 mm); CrV; 1/4" (6.3 mm): 2, 2.5, 3, 4, 5, 5.5, 6 mm (L=25 mm); CrV; 1/4" (6.3 mm): S0, S1, S2, S3 (L=25 mm); CrV; 1/4" (6.3 mm); (L=60 mm); CrV



No.	pcs / szt.	📦
66301	41	10/40

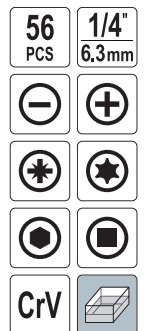

EN Screwdriver bit set
 PL Zestaw końcówek śrubokrętowych
 DE Schraubendreherbitsatz
 RU Набор битов
 CS Sada bitů
 RO Truse bit
 HU Bitkészlet
 ES Puntas de destornilladora

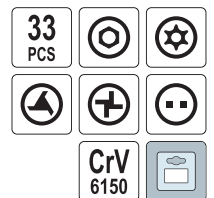

1/4" (6.3 mm): T8, T10, T15, T20, T25, T27, T30, T35, T40 (L=25 mm); 5/64" (2.0 mm), 3/32" (2.4 mm), 7/64" (2.8 mm), 1/8" (3.2 mm), 9/64" (3.6 mm), 5/32" (4.0 mm) (L=25 mm); 1/4" (6.3 mm): 2, 2.5, 3, 4, 5, 6 mm (L=25 mm); 1/4" (6.3 mm): 1, 2, 3, 4 (L=25 mm); 1/4" (6.3 mm): 6, 8, 10 (L=25 mm); 1/4" (6.3 mm): 4, 6, 8, 10 (L=25 mm); 1/4" (6.3 mm); (L=60 mm)



No.	pcs / szt.	📦
66330	33	12/60

EN Screwdriver bit set
 PL Zestaw końcówek śrubokrętowych
 DE Schraubendreherbitsatz
 RU Набор битов

CS Sada bitů
 RO Truse bit
 HU Bitkészlet
 ES Puntas de destornilladora



No.	pcs / szt.	
66400	40	10

EN Screwdriver bit set
 PL Zestaw końcówek śrubokrętowych
 DE Schraubendreherbitsatz
 RU Набор битов

CS Sada bitů
 RO Truse bit
 HU Bitkészlet
 ES Puntas de destornilladora



3/8" (9.5 mm): T20, T25, T30, T40, T45, T50, T55 (L=30 mm); 3/8" (9.5 mm): T20, T25, T30, T40, T45, T50, T55 (L=75 mm);
 4, 5, 6, 7, 8, 10, 12 mm (L=30 mm); 4, 5, 6, 7, 8, 10, 12 mm (L=75 mm); M5, M6, M8, M10, M12 (L=30 mm); M5, M6, M8, M10, M12 (L=75 mm)



No.	pcs / szt.	
66410	40	10

EN Screwdriver bit set
 PL Zestaw końcówek śrubokrętowych
 DE Schraubendreherbitsatz
 RU Набор битов

CS Sada bitů
 RO Truse bit
 HU Bitkészlet
 ES Puntas de destornilladora



3/8" (9.5 mm): T20, T25, T30, T40, T45, T50, T55 (L=30 mm); 3/8" (9.5 mm): T20, T25, T30, T40, T45, T50, T55 (L=75 mm); 1/2" (12.7 mm) x 3/8" (9.5 mm)



No.	pcs / szt.	
66580	15	20

EN Screwdriver bit set
 PL Zestaw końcówek śrubokrętowych
 DE Schraubendreherbitsatz
 RU Набор битов

CS Sada bitů
 RO Truse bit
 HU Bitkészlet
 ES Puntas de destornilladora

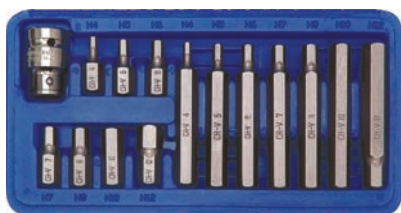

3/8" (9.5 mm): 4, 5, 6, 7, 8, 10, 12 (L=30 mm); 3/8" (9.5 mm): 4, 5, 6, 7, 8, 10, 12 (L=75 mm); 1/2" (12.7 mm) x 3/8" (9.5 mm)



No.	pcs / szt.	
66720	15	20

3/8" (9.5 mm): T20, T25, T30, T40, T45, T50, T55 (L=30 mm); 3/8" (9.5 mm): T20, T25, T30, T40, T45, T50, T55 (L=75 mm); 3/8" (9.5 mm): 4, 5, 6, 7, 8, 10, 12 mm (L=30 mm); 3/8" (9.5 mm): 4, 5, 6, 7, 8, 10, 12 mm (L=75 mm); 3/8" (9.5 mm): M5, M6, M8, M10, M12 (L=30 mm); 3/8" (9.5 mm): M5, M6, M8, M10, M12 (L=75 mm); 1/2" (12.7 mm) x 3/8" (9.5 mm), 3/8" (9.5 mm) x 3/8" (9.5 mm)

EN Screwdriver bit set
 PL Zestaw końcówek śrubokrętowych
 DE Schraubendreherbitsatz
 RU Набор битов

CS Sada bitů
 RO Truse bit
 HU Bitkészlet
 ES Puntas de destornilladora



3/8" (9.5 mm): T25, T30, T40, T45, T50, T55 (L=30 mm);
 1/2" (12.7 mm) x 3/8" (9.5 mm)



No.	pcs / szt.	
66570	7	24/72

EN Screwdriver bit set
 PL Zestaw końcówek śrubokrętowych
 DE Schraubendreherbitsatz
 RU Набор битов

CS Sada bitů
 RO Truse bit
 HU Bitkészlet
 ES Puntas de destornilladora



3/8" (9.5 mm): 4, 5, 6, 8, 10, 12 mm (L=30 mm); 1/2" (12.7 mm) x 3/8" (9.5 mm)



No.	pcs / szt.	
66710	7	24/72

EN Screwdriver bit set
 PL Zestaw końcówek śrubokrętowych
 DE Schraubendreherbitsatz
 RU Набор битов

CS Sada bitů
 RO Truse bit
 HU Bitkészlet
 ES Puntas de destornilladora



3/8" (9.5 mm): M5, M6, M8, M10, M12 (L=30 mm); 1/2" (12.7 mm) x 3/8" (9.5 mm)



No.	pcs / szt.	
66760	6	24/72

EN Screwdriver bit set
 PL Zestaw końcówek śrubokrętowych
 DE Schraubendreherbitsatz
 RU Набор битов

CS Sada bitů
 RO Truse bit
 HU Bitkészlet
 ES Puntas de destornilladora

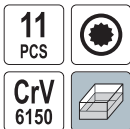

3/8" (9.5 mm): M5, M6, M8, M10, M12 (L=30 mm); 3/8" (9.5 mm): M5, M6, M8, M10, M12 (L=75 mm);
 1/2" (12.7 mm) x 3/8" (9.5 mm)



No.	pcs / szt.	Box
66770	11	20

EN Screwdriver bit set
 PL Zestaw końcówek śrubokrętowych
 DE Schraubendreherbitsatz
 RU Набор битов

CS Sada bitů
 RO Truse bit
 HU Bitkészlet
 ES Puntas de destornilladora



No.	pcs / szt.	Box
66112	10	25/100

EN Screwdriver bit set
 PL Zestaw końcówek śrubokrętowych
 DE Schraubendreherbitsatz
 RU Набор битов

CS Sada bitů
 RO Truse bit
 HU Bitkészlet
 ES Puntas de destornilladora



No.	pcs / szt.	Box
66200	20	12/48

EN Screwdriver bit set
 PL Komplet końcówek nasadowych
 DE Bit-Steckschlüsselsatz
 RU Набор торцевых головок

CS Sada nastrčných koncoviek
 RO Set de capete tubulare
 HU Csökcúlszékészlet
 ES Juego de puntas de calar

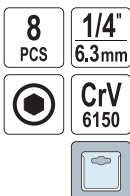

1/4" (6.3 mm): 5, 6, 7, 8, 9, 10, 11, 13 mm; CrV 6150



No.	pcs / szt.	Box
66113	8	25/50

EN Screwdriver bit set
 PL Zestaw końcówek śrubokrętowych
 DE Schraubendreherbitsatz
 RU Набор битов

CS Sada bitů
 RO Truse bit
 HU Bitkészlet
 ES Puntas de destornilladora



No.	pcs / szt.	Box
66080	7	20/200

EN Screwdriver bit holder
 PL Uchwyt do końcówek śrubokrętowych
 DE Bithalter
 RU Магнитный держатель

CS Držák na šroubovákovekoncevky
 RO Capete șurubelniță
 HU Szár a csavarhúzóvégekhez
 ES Mandril para puntas

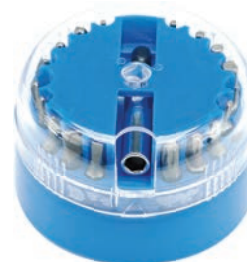

No.	pcs / szt.	Box
66210	20	12/48

EN Angle adapter
 PL Adapter kątowy
 DE Winkelschrauber
 RU Адаптер угловой для бит

CS Úhel elektrická vrtačka připojení adaptéru
 RO Dispozitiv unghiular de insurubat
 HU Sarokcsavarozó adapter
 ES Ángulo magnético bit driver adaptador



No.	Box
65850	30/300

EN Angle adapter
 PL Adapter kątowy
 DE Winkelschrauber
 RU Адаптер угловой для бит

CS Úhel elektrická vrtačka připojení adaptéru
 RO Dispozitiv unghiular de insurubat
 HU Sarokcsavarozó adapter
 ES Ángulo magnético bit driver adaptador

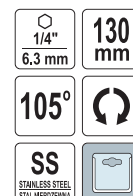

No.	1/4" (6.3 mm)	L [mm]	Box
65840		130	60

EN T-handle hex key
 PL Klucz sześciokątny typu "T"
 DE T-Griff Sechskant Stiftschlüssel
 RU Ключ HEX T-образный с рукояткой
 CS Imbusový klíč s T-rukojetí
 RO Cheie Hexagonala Tip "T"
 HU Imbuskulcs T-markolattal
 ES Llave allen con mango en "T" para tornillos con hexágono interno

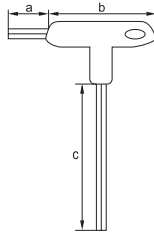

No.	⊙ [mm]	a [mm]	b [mm]	c [mm]	📦
56640	2.0	10	59	100	24/240
56641	2.5	12	59	100	24/240
56642	3.0	13	59	100	24/240
56643	4.0	13	76	150	24/192
56644	5.0	14	76	150	24/192
56645	6.0	14	76	150	24/192
56646	7.0	16	95	200	12/72
56647	8.0	18	95	200	12/72
56648	10.0	20	95	200	12/72

EN T-handle hex key set
 PL Zestaw kluczy sześciokątnych typu "T"
 DE T-Griff Sechskant Stiftschlüsselsatz
 RU Набор ключей Hex с T-образной рукояткой
 CS Sada imbusů "T" rukojetí
 RO Set chei hexagonale tip "T"
 HU Imbuskulcs T-markolattal készlet
 ES Juego de llaves Allen con mango en "T"

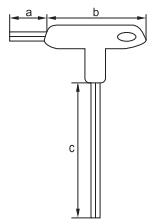

No.	⊙ [mm]	a [mm]	b [mm]	c [mm]	pcs / szt.	📦
56649	2.5, 3, 4,	12, 13, 13,	59, 59, 76,	100, 100,	8	12/24
	5, 6, 7,	14, 14, 16,	76, 76, 95,	150, 150,		
	150, 200,	18, 20	95, 95	200, 200,		
	8, 10					

EN T-handle hex key with ball
 PL Klucz sześciokątny typu "T" z kulka
 DE T-Griff Sechskant Stiftschlüssel mit Kugel
 RU Ключ HEX T-образный с шаровой головкой
 CS T-tyč imbusového klíče s kulovou hlavou
 RO Cheie hexagonala cu bila tip "T"
 HU Imbuskulcs T-markolattal gömbfej
 ES Llave allen con el tipo de pelota "T"

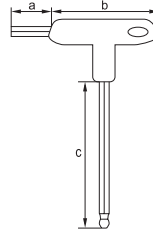
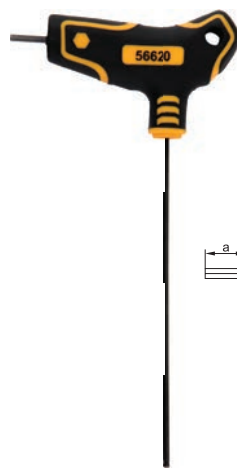

No.	⊙ [mm]	a [mm]	b [mm]	c [mm]	📦
56620	2.0	10	59	100	24/240
56621	2.5	12	59	100	24/240
56622	3.0	13	59	100	24/240
56623	4.0	13	76	150	24/192
56624	5.0	14	76	150	24/192
56625	6.0	14	76	150	24/192
56626	7.0	16	95	200	12/72
56627	8.0	18	95	200	12/72
56628	10.0	20	95	200	12/72

EN T-handle hex key set with ball
 PL Zestaw kluczy sześciokątnych typu "T" z kulka
 DE T-Griff Sechskant Stiftschlüsselsatz mit Kugel
 RU Набор ключей Hex с T-образной рукояткой
 CS Sada imbusů s kulčkou a "T" rukojetí
 RO Set chei hexagonale cu bila tip "T"
 HU Imbuskulcs T-markolattal készlet
 ES Juego de llaves Allen con mango en "T"

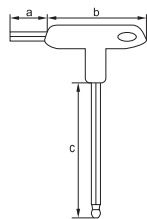

No.	⊙ [mm]	a [mm]	b [mm]	c [mm]	pcs / szt.	📦
56629	2.5, 3, 4,	12, 13, 13,	59, 59, 76,	100, 100,	8	12/24
	5, 6, 7,	14, 14, 16,	76, 76, 95,	150, 150,		
	150, 200,	18, 20	95, 95	200, 200,		
	8, 10					

EN T-handle Torx key
 PL Klucz Torx typu "T"
 DE T-Griff Torx-Schlüssel
 RU Ключ Torx T-образный с рукояткой
 CS Torx klíč s T-rukojetí
 RO Cheie Torx tip "T"
 HU Torx kulcs T-markolattal
 ES Torx llave en forma de "T" con un mango

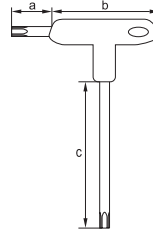
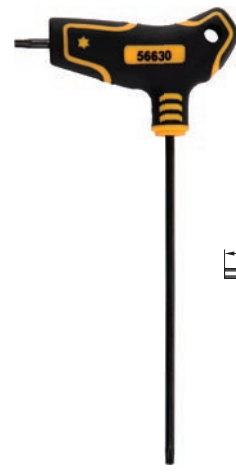

No.	⊙ [mm]	a [mm]	b [mm]	c [mm]	📦
56630	T10	10	59	100	24/240
56631	T15	12	59	100	24/240
56632	T20	13	59	100	24/192
56633	T25	13	76	150	24/192
56634	T27	14	76	150	24/192
56635	T30	14	76	150	24/192
56636	T40	16	95	200	12/72
56637	T45	18	95	200	12/72
56638	T50	20	95	200	12/72

EN T-handle Torx key set
 PL Zestaw kluczy Torx typu "T"
 DE T-Griff Torx-Schlüsselsatz
 RU Набор ключей Torx с T-образной рукояткой
 CS Klíče typ "T" Torx sada
 RO Set chei Torx tip "T"
 HU T-nyelű Torx kulcs készlet
 ES T-tipo llave Torx set

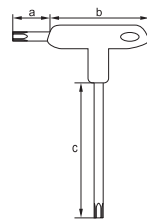

No.	⊙ [mm]	a [mm]	b [mm]	c [mm]	pcs / szt.	📦
56639	T10, T15,			100, 100,	9	12/24
	T20, T25,	10, 12, 13,	59, 59, 59,	100, 150,		
	T27, T30,	13, 14, 14,	76, 76, 76,	150, 150,		
	T40, T45,	16, 18, 20	95, 95, 95	200, 200,		
	T50			200		
				200		

EN Hex key
 PL Klucz sześciokątny
 DE Sechskant-Stiftschlüssel
 RU Шестигранник
 CS Imbusový klíč
 RO Cheie imbus
 HU Imbisz kulcs
 ES Llave hexagonal



3



No.	⌀ [mm]	
56040	4	1000/2000
56050	5	400/800
56060	6	400/800
56070	7	300/600
56080	8	200/400
56100	10	100/200
56120	12	50/100
56130	13	50/100
56140	14	50/100
56170	17	25/50

EN Hex key set
 PL Zestaw kluczy imbusowych
 DE Sechskant-Stiftschlüsselsatz
 RU Набор шестигранников
 CS Imbusové klíče
 RO Cheie imbus
 HU Imbisz kulcs
 ES Juego de llaves Hex

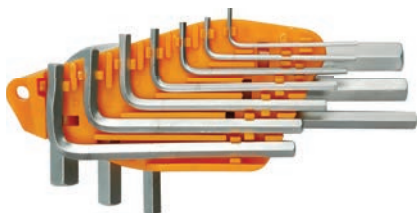
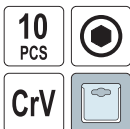

VOREL

No.	⌀ [mm]	pcs / szt.	
56393	1.5, 2, 2.5, 3, 4, 5, 5.5, 6, 8, 10	10	10/60

EN Hex key set
 PL Zestaw kluczy imbusowych
 DE Sechskant-Stiftschlüsselsatz
 RU Набор шестигранников
 CS Imbusové klíče
 RO Cheie imbus
 HU Imbisz kulcs
 ES Juego de llaves Hex

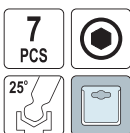

No.	⌀ [mm]	pcs / szt.	
56470	2.5, 3, 4, 5, 6, 8, 10	7	20/40

EN Hex key set
 PL Zestaw kluczy imbusowych
 DE Sechskant-Stiftschlüsselsatz
 RU Набор шестигранников
 CS Imbusové klíče
 RO Cheie imbus
 HU Imbisz kulcs
 ES Juego de llaves hex



No.	⌀ [mm]	pcs / szt.	
56380	2, 2.5, 3, 4, 5, 6, 8, 10	8	20/100
56390	1.5, 2, 2.5, 3, 4, 5, 6, 7, 8, 10	10	20/100

EN Hex key set
 PL Zestaw kluczy imbusowych
 DE Sechskant-Stiftschlüsselsatz
 RU Набор шестигранников
 CS Imbusové klíče
 RO Cheie imbus
 HU Imbisz kulcs
 ES Juego de llaves hex



VOREL

No.	⌀ [mm]	pcs / szt.	
56391	1.5, 2, 2.5, 3, 3.5, 4, 5, 6, 8, 10	10	20/100
56392	2, 2.5, 3, 4, 5, 6, 8, 10	8	20/100

EN Hex key set
 PL Zestaw kluczy imbusowych
 DE Sechskant-Stiftschlüsselsatz
 RU Набор шестигранников
 CS Imbusové klíče
 RO Cheie imbus
 HU Imbisz kulcs
 ES Juego de llaves Hex



No.	⌀ [mm]	pcs / szt.	
56400	2, 2.5, 3, 4, 5, 6, 8, 10, 12, 14	10	20/40

EN Hex key set
 PL Zestaw kluczy imbusowych
 DE Sechskant-Stiftschlüsselsatz
 RU Набор шестигранников
 CS Imbusové klíče
 RO Cheie imbus
 HU Imbisz kulcs
 ES Juego de llaves Hex



VOREL

No.	⌀ [mm]	pcs / szt.	
56473	1.5, 2, 2.5, 3, 4, 5, 6, 8	8	10/60

EN Hex key set
 PL Zestaw kluczy imbusowych
 DE Sechkant-Stiftschlüsselsatz
 RU Набор шестигранников
 CS Imbusové klíče
 RO Chei imbus
 HU Imbisz kulcs
 ES Juego de llaves Hex

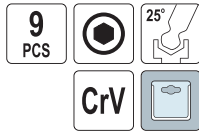

No.	⌀ [mm]	pcs / szt.	
56475	2.5, 3, 4, 5, 5.5, 6, 7, 8, 10	9	10/60

EN Hex key set
 PL Zestaw kluczy imbusowych
 DE Sechkant-Stiftschlüsselsatz
 RU Набор шестигранников
 CS Imbusové klíče
 RO Chei imbus
 HU Imbisz kulcs
 ES Juego de llaves Hex

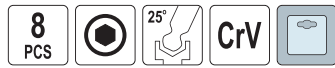

No.	⌀ [mm]	pcs / szt.	
56505	1.5, 2, 2.5, 3, 4, 5, 6, 8	8	25/100

EN Torx key set
 PL Zestaw kluczy Torx
 DE Torx Schlüsselsatz
 RU Набор ключи Torx
 CS Souprava klíčů Torx
 RO Set de chei Torx
 HU Kulcskészlet Torx
 ES Juego de llaves Torx

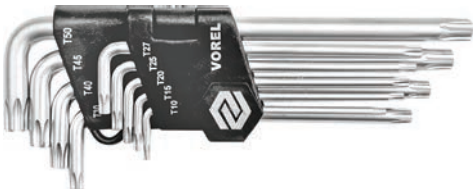

No.	⌀	pcs / szt.	
56478	T10, T15, T20, T25, T27, T30, T40, T45, T50	9	20/40

EN Torx key set
 PL Zestaw kluczy Torx
 DE Torx Schlüsselsatz
 RU Набор ключи Torx
 CS Souprava klíčů Torx
 RO Set de chei Torx
 HU Kulcskészlet Torx
 ES Juego de llaves Torx



No.	⌀	pcs / szt.	
56507	T9, T10, T15, T20, T25, T27, T30, T40	8	25/100

EN Hex key set
 PL Zestaw kluczy imbusowych
 DE Sechkant-Stiftschlüsselsatz
 RU Набор шестигранников
 CS Imbusové klíče
 RO Chei imbus
 HU Imbisz kulcs
 ES Juego de llaves Hex

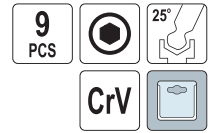

No.	⌀ [mm]	pcs / szt.	
56477	2, 2.5, 3, 4, 5, 5.5, 6, 8, 10	9	10/60

EN Hex key set
 PL Zestaw kluczy imbusowych
 DE Sechkant-Stiftschlüsselsatz
 RU Набор шестигранников
 CS Imbusové klíče
 RO Chei imbus
 HU Imbisz kulcs
 ES Juego de llaves Hex



No.	⌀ [mm]	pcs / szt.	
56506	1.5, 2, 2.5, 3, 4, 5, 6, 8	8	25/100

EN Torx key set
 PL Zestaw kluczy Torx
 DE Torx Schlüsselsatz
 RU Набор ключи Torx
 CS Souprava klíčů Torx
 RO Set de chei Torx
 HU Kulcskészlet Torx
 ES Juego de llaves Torx



No.	⌀	pcs / szt.	
56600	T10, T10, T15, T20, T25, T27, T30, T40	8	50/100



4

Pliers & pipe wrenches Szczypce i klucze do rur



Pliers, heavy duty blue handle Szczypce, uchwyt niebieski

46



Combination pliers Szczypce uniwersalne.....	46
Side cutting pliers Szczypce tnące, boczne.....	46
Long nose pliers Szczypce wydłużone, proste.....	46
Bent nose pliers Szczypce wydłużone, wygięte.....	46

Pliers, 2 colour handle Szczypce, dwukolorowa rączka

46-47



Combination pliers Szczypce uniwersalne.....	46
Side cutting pliers Szczypce tnące, boczne.....	46
Long nose pliers Szczypce wydłużone, proste.....	46
Bent nose pliers Szczypce wydłużone, wygięte.....	46
Round nose pliers Szczypce okrągłe.....	47
Wire stripping pliers Szczypce do ściągania izolacji.....	47
End cutting pliers Szczypce tnące, czołowe.....	47
Water pump pliers Szczypce nastawne.....	47

Chrome plated pliers Szczypce chromowane

47



Water pump pliers Szczypce nastawne.....	47
--	----

Pincers & pliers Szczypce i obcęgi

47



End cutting pliers Szczypce tnące, czołowe.....	47
Carpenter's pincers Obcęgi.....	47
Tower pincers Szczypce tynkarskie.....	47

Profile connection pliers Szczypce do łączenia profili

48



Pliers „Juco” Szczypce „Juco”

48



Combination pliers Szczypce uniwersalne.....	48
Side cutting pliers Szczypce tnące, boczne.....	48

Mini pliers Szczypce „Mini”

48-49



Combination pliers Szczypce uniwersalne.....	48
Side cutting pliers Szczypce tnące, boczne.....	48
Long nose pliers Szczypce wydłużone, proste.....	48
Bent nose pliers Szczypce wydłużone, wygięte.....	49
Flat nose pliers Szczypce płaskie.....	49
Round nose pliers Szczypce okrągłe.....	49
End cutting pliers Szczypce tnące, czołowe.....	49
Mini pliers sets Zestawy szczypiec „Mini”.....	49

Circlip pliers Szczypce Segera

49-50



Lock grip pliers & sets Szczypce zaciskowe i zestawy

50-51



Water pump pliers Szczypce nastawne

51



Pipe wrenches Klucze do rur

52-53



Pipe wrenches Stillson type Klucze do rur typu Stillson.....	52
Adjustable pipe wrenches Klucze do rur nastawne.....	52
Adjustable wrenches Klucze nastawne francuskie.....	53

Chain pipe wrenches Klucze do rur łańcuchowe

53



EN Combination pliers
 PL Szczypce uniwersalne
 DE Kombinationszange
 RU Плоскогубцы универсальные
 CS Univerzální kleště
 RO Patent universal
 HU Kombináltfogó
 ES Alicates universal



VOREL

No.	L [mm]	
40010	160	6/60
40011	180	6/60
40012	200	6/60

EN Long nose pliers
 PL Szczypce wydłużone proste
 DE Radiozange
 RU Тонкогубцы
 CS Prodloužené kleště rovné
 RO Patent drept alungit
 HU Rádiófogó, egyenes
 ES Alicates de punta



VOREL

No.	L [mm]	
40013	160	6/120
40014	200	6/60

EN Combination pliers
 PL Szczypce uniwersalne
 DE Kombinationszange
 RU Плоскогубцы универсальные
 CS Univerzální kleště
 RO Patent universal
 HU Kombináltfogó
 ES Alicates universal



VOREL

No.	L [mm]	
40041	160	6/60
40042	180	6/60
40043	200	6/60

EN Long nose pliers
 PL Szczypce wydłużone proste
 DE Radiozange
 RU Тонкогубцы
 CS Prodloužené kleště rovné
 RO Patent drept alungit
 HU Rádiófogó, egyenes
 ES Alicates de punta



VOREL

No.	L [mm]	
40044	160	6/120
40045	180	6/60

EN Diagonal side cutting pliers
 PL Szczypce tnące boczne
 DE Seitenschneider
 RU Бокорезы
 CS Rezačí kleště boční
 RO Patent de tăiat lateral
 HU Oldal csípőfogó
 ES Alicates corte lateral



VOREL

No.	L [mm]	
40017	160	6/60
40018	180	6/60

EN Bent nose pliers
 PL Szczypce wydłużone wygięte
 DE Telefonzange
 RU Тонкогубцы изогнутые
 CS Prodloužené kleště ohnuté
 RO Patent curbă alungit
 HU Rádió- és telefonfogó, hajlított
 ES Alicates curvos



VOREL

No.	L [mm]	
40015	160	6/120
40016	200	6/60

EN Diagonal side cutting pliers
 PL Szczypce tnące boczne
 DE Seitenschneider
 RU Бокорезы
 CS Rezačí kleště boční
 RO Patent de tăiat lateral
 HU Oldal csípőfogó
 ES Alicates corte lateral



VOREL

No.	L [mm]	
40047	160	6/120
40048	180	6/60

EN Bent nose pliers
 PL Szczypce wydłużone wygięte
 DE Telefonzange
 RU Тонкогубцы изогнутые
 CS Prodloužené kleště ohnuté
 RO Patent curbă alungit
 HU Rádió- és telefonfogó, hajlított
 ES Alicates curvos



VOREL

No.	L [mm]	
40050	160	6/120
40051	180	6/60

EN Round nose pliers
 PL Szczypce okrągłe
 DE Rundzange
 RU Крупоножцы
 CS Kruhové kleště
 RO Patent rotund
 HU Kerekcsőrű fogó
 ES Alicates redondos

160
 PCS



No.	L [mm]	
40054	160	6/120

EN End cutting pliers
 PL Szczypce tnące czolowe
 DE Vornsneider
 RU Кусачки торцевые
 CS Kleště štípací čelní
 RO Cleste retezat
 HU Homlokcsípő fogó
 ES Cortacables frontales

160
 mm



No.	L [mm]	
40055	160	6/60

EN Water pump pliers
 PL Szczypce tnące czolowe
 DE Wasserpumpenzange
 RU Кусачки торцевые
 CS Hydraulické kleště nastaviteľné
 RO Cleste instalator tip papagal
 HU Állítható csőfogó
 ES Alicates de fontanero

250
 mm

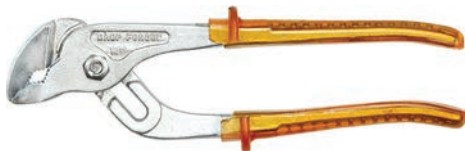

No.	L [mm]	
41500	250	6/60

EN Carpenter's pincers
 PL Obcegi
 DE Kneifzange
 RU Клещи строительные
 CS Kleště
 RO Clește
 HU Harapófogó
 ES Tenazas



No.	L [mm]	
41151	180	6/60
41152	200	6/60

EN Wire stripping pliers
 PL Szczypce do ściągania izolacji
 DE Abisolierzange
 RU Клещи для снятия изоляции
 CS Kleště na sundávání izolace
 RO Patent pt. decablat
 HU Szigeteléseltávolító fogó
 ES Pinzas pelacables

160
 mm



No.	L [mm]	
40056	160	6/60

EN Water pump pliers
 PL Szczypce tnące
 DE Wasserpumpenzange
 RU Клещи переставные
 CS Hydraulické kleště nastaviteľné
 RO Cleste instalator tip papagal
 HU Állítható csőfogó
 ES Alicates de fontanero

250
 mm



No.	L [mm]	
40057	250	6/60

EN End cutting pliers
 PL Szczypce tnące czolowe
 DE Vornsneider
 RU Кусачки торцевые
 CS Kleště štípací čelní
 RO Cleste retezat
 HU Homlokcsípő fogó
 ES Cortacables frontales

180
 mm



No.	L [mm]	
41121	180	6/60

EN Tower pincers
 PL Obcegi tynkarskie
 DE Beisszange
 RU Клещи штукатурные
 CS Kleště štípací čelní
 RO Clește pt. cuie
 HU Rabitzfogó
 ES Tenazas de enlucido

250
 mm



No.	L [mm]	
41381	250	6/60

EN Profile connection pliers
 PL Szczypce do łączenia profili
 DE Profil Verbundzange
 RU Клещи для соединения профилей
 CS Kleště do spojování profilů
 RO Cleste sertizat profile rigips
 HU Profilösszekítő fogó
 ES Alicates para unir perfiles

280 mm 65Mn



VOREL

No.	L [mm]	
04300	280	6/36

EN Combination pliers
 PL Szczypce uniwersalne
 DE Kombinationszange
 RU Плоскогубцы универсальные
 CS Univerzální kleště
 RO Patent universal
 HU Kombináltfogó
 ES Alicates universal

1000 V



JUKO

No.	L [mm]	Voltage / Napiecie [V]	
40160	160	1000	10/50
40180	180	1000	10/50
40200	200	1000	10/50

EN Combination pliers
 PL Szczypce uniwersalne
 DE Kombinationszange
 RU Плоскогубцы универсальные
 CS Univerzální kleště
 RO Patent universal
 HU Kombináltfogó
 ES Alicates universal

120 mm



VOREL

No.	L [mm]	
42300	120	12/120

EN Long nose pliers
 PL Szczypce wydłużone proste
 DE Radiozange
 RU Тонкогубцы
 CS Prodloužené kleště rovné
 RO Patent drept alungit
 HU Rádiófogó, egyenes
 ES Alicates de punta

125 mm



VOREL

No.	L [mm]	
42303	125	12/120

EN Profile connection pliers
 PL Szczypce do łączenia profili
 DE Profil Verbundzange
 RU Клещи для соединения профилей
 CS Kleště do spojování profilů
 RO Cleste sertizat profile rigips
 HU Profilösszekítő fogó
 ES Alicates para unir perfiles

300 mm



VOREL

No.	L [mm]	
04301	300	6/24

EN Diagonal side cutting pliers
 PL Szczypce tnące boczne
 DE Seitenschneider
 RU Бокорезы
 CS Řezací kleště boční
 RO Patent de tăiat lateral
 HU Oldal cspőfogó
 ES Alicates corte lateral

160 mm 1000 V



JUKO

No.	L [mm]	Voltage / Napiecie [V]	
40700	160	1000	10/50

EN Diagonal side cutting pliers
 PL Szczypce tnące boczne
 DE Seitenschneider
 RU Бокорезы
 CS Řezací kleště boční
 RO Patent de tăiat lateral
 HU Oldal cspőfogó
 ES Alicates corte lateral

110 mm



VOREL

No.	L [mm]	
42301	110	12/120

EN Long nose pliers
 PL Szczypce wydłużone proste
 DE Radiozange
 RU Тонкогубцы
 CS Prodloužené kleště rovné
 RO Patent drept alungit
 HU Rádiófogó, egyenes
 ES Alicates de punta

150 mm



VOREL

No.	L [mm]	
42305	150	12/120

EN Long nose pliers
 PL Szczypce wydłużone proste
 DE Radiozange
 RU Тонкогубцы
 CS Prodloužené kleště rovné
 RO Patent drept alungit
 HU Rádiófógó, egyenes
 ES Alicates de punta



No.	L [mm]	
42305	150	12/120

EN Flat nose pliers
 PL Szczypce płaskie
 DE Flachzange
 RU Плоскогубцы удлиненные
 CS Kleště ploché
 RO Clește cu vârf ascuțit
 HU Rádiófógó, egyenes
 ES Alicates de bocas planas



No.	L [mm]	
42306	120	12/120

EN End cutting pliers
 PL Szczypce tnące czołowe
 DE Vornschneider
 RU Кусачки торцевые
 CS Kleště štípací čelní
 RO Clește retezat
 HU Homlokcsípő fogó
 ES Cortacables frontales



No.	L [mm]	
42302	110	12/120

EN Mini pliers set
 PL Zestaw miniszczypiec
 DE Mini-Zangensatz
 RU Пассатижи в наборе
 CS Elektronické kleště
 RO Set mini patenti
 HU Elektronikai fogó
 ES Alicates electronicas



No.	pcs / szt.	
42309	6	4/40

EN Bent nose pliers
 PL Szczypce wydłużone wygięte
 DE Telefonzange
 RU Тонкогубцы изогнутые
 CS Prodloužené kleště ohnuté
 RO Patent curbat alungit
 HU Rádió- és telefonfogó hajlítót
 ES Alicates curvos



No.	L [mm]	
42304	125	12/120

EN Round nose pliers
 PL Szczypce okrągłe
 DE Rundzange
 RU Круглогубцы
 CS Kruhové kleště
 RO Patent rotund
 HU Kerekcsőrű fogó
 ES Alicates redondos



No.	L [mm]	
42307	125	12/120

EN Mini pliers set
 PL Zestaw miniszczypiec
 DE Mini-Zangensatz
 RU Пассатижи в наборе
 CS Elektronické kleště
 RO Set mini patenti
 HU Elektronikai fogó
 ES Alicates electronicas



No.	pcs / szt.	
42308	4	5/50

EN Circclip pliers, external straight
 PL Szczypce Segera, zewnętrzne proste
 DE Seegeringzange aussen. ger.
 RU Съемник стопорных колец (разжим)
 CS Kleště Segera vnější rovné
 RO Clește Seger exterior drept
 HU Segerfogó külső, egyenes
 ES Alicates Seger exter. de punta



No.	L [mm]	
43050	160	6/60
43055	180	6/60
43060	200	6/60

EN Circlip pliers, external bent
 PL Szczypce Segera, zewnętrzne wygięte
 DE Seegeringzange aussen. geb.
 RU Съёмник стопорных колец (разжим)

CS Kleště Segera vnější ohnuté
 RO Clește Seger exterior curbat
 HU Segerfogó külső, hajlítot
 ES Alicates seger exter. curvos



VOREL

No.	L [mm]	Icon
43051	160	6/60
43056	180	6/60
43061	200	6/60

EN Circlip pliers, internal bent
 PL Szczypce Segera, wewnętrzne wygięte
 DE Seegeringzange inner. geb.
 RU Съёмник стопорных колец (сжим)

CS Kleště Segera vnitřní ohnuté
 RO Patent Seger interior curbat
 HU Segerfogó belső, hajlítot
 ES Alicates Seger inter. curvos



VOREL

No.	L [mm]	Icon
43053	160	6/60
43058	180	6/60
43063	200	6/60

EN Lock grip pliers
 PL Szczypce Morse'a
 DE Gripzange
 RU Зажим ручной

CS Kleště Morse'a
 RO Clește Morse
 HU Morse fogó
 ES Alicates Morse



No.	L [mm]	Icon
44100	250	6/60

EN Locking pliers set
 PL Zestaw szczypiec Morse'a
 DE Gripzangen-Set
 RU Набор клещей Морса
 CS Sada kleští siko
 RO Set clești autoblocanți
 HU Morse fogókészlet
 ES Juego de pinzas morsa

VOREL

No.	L [mm]	pcs / szt.	Icon
44110	140, 165, 185, 225	4	5/20

EN Circlip pliers, internal straight
 PL Szczypce Segera, wewnętrzne proste
 DE Seegeringzange inner. ger.
 RU Съёмник стопорных колец (сжим)

CS Kleště Segera vnitřní rovné
 RO Clește Seger interior drept
 HU Segerfogó belső, egyenes
 ES Alicates seger inter. de punta



VOREL

No.	L [mm]	Icon
43052	160	6/60
43057	180	6/60
43062	200	6/60

EN Circlip pliers set
 PL Szczypce Segera
 DE Seegeringzange
 RU Съёмник стопорных колец
 CS Kleště Segera
 RO Clește pt. inele de siguranța
 HU Segerfogó
 ES Alicates Seger



No.	L [mm]	pcs / szt.	Icon
43510	150	5	12/60

EN Lock grip pliers
 PL Szczypce Morse'a
 DE Gripzange
 RU Зажим ручной

CS Kleště Morse'a
 RO Clește Morse
 HU Morse fogó
 ES Alicates Morse



No.	L [mm]	Icon
44102	250	6/60



L=140, 165, 225 mm;
 L=180 mm

EN Lock grip pliers
 PL Szczypce spawalnicze
 DE Schweisserzange
 RU Клещи зажимные сварочные
 CS Svářečské kleště
 RO Cleste autoblocant pt. sudura
 HU Hegesztő fogó
 ES Alicates de soldar

0-70 mm 275 mm
 C TYPE



No.	L [mm]	Type / Typ	6/36
44300	275	C	6/36

EN Lock grip pliers
 PL Szczypce spawalnicze
 DE Schweisserzange
 RU Клещи зажимные сварочные
 CS Svářečské kleště
 RO Cleste autoblocant pt. sudura
 HU Hegesztő fogó
 ES Alicates de soldar

0-60 mm 225 mm
 U TYPE



No.	L [mm]	Type / Typ	6/36
44400	225	U	6/36

EN Mini locking pliers set
 PL Zestaw szczypiec spawalniczych mini
 DE Mini-Schweißzangen-Satz
 RU Набор сварочных мини-клещей
 CS Sada svařovacích kleští mini
 RO Set mini clești autoblocanti
 HU Mini testcsipesz készlet
 ES Juego de mini pinzas para soldar

4 PCS HRC 45-48

L=110 mm;
 L=125 mm;
 L=130 mm x2



No.	L [mm]	pcs / szt.	6/24
44330	110, 125, 130, 130	4	6/24

EN Welding locking pliers „C” type
 PL Szczypce zaciskowe klamrowe typu „C”
 DE Klemm- und Klammerzange vom Typ „C”
 RU Клещи зажимные сварочные
 CS Kleště samosvorné upínací typu „C”
 RO Clește de strângere cu clemă tip „C”
 HU „C” fogó
 ES Pinzas de tornillo (de apriete) de grapa tipo „C”

0-70 mm 280 mm
 C TYPE



No.	L [mm]	Type / Typ	5/30
44301	280	C	5/30

EN Lock grip pliers
 PL Szczypce spawalnicze
 DE Schweisserzange
 RU Клещи зажимные сварочные
 CS Svářečské kleště
 RO Cleste autoblocant pt. sudura
 HU Hegesztő fogó
 ES Alicates de soldar

0-65 mm 250 mm 95 mm
 SM TYPE



No.	L [mm]	Type / Typ	6/36
44500	250	SM	6/36

EN Water pump pliers
 PL Szczypce hydrauliczne nastawne
 DE Wasserpumpenzange
 RU Клещи переставные
 CS Keleště siko
 RO Cleste papagal
 HU Vízpumpafogó
 ES Alicates de fontanero ajustables

250 mm 7 POSITIONS POZICIE



No.	L [mm]	10/50
41510	250	10/50

EN Pipe wrench
 PL Klucz do rur
 DE Rohrschlüssel
 RU Ключ трубный
 CS Klíč součásti na trubky
 RO Chei pt. țevi
 HU Csőkulcs
 ES Llave de fontanero



No.	L [mm]	
55250	250	6/48
55300	300	6/36
55350	350	6/24

EN Adjustable pipe wrench
 PL Klucz nastawny do rur
 DE Rohrschlüssel
 RU Ключ трубный
 CS Nastavitelný klíč na trubky
 RO Cheie reglabilă pt. țevi
 HU Állítható csőkulcs
 ES Llave de vaso para tubería

45°



No.	Max. pipe diameter / Maks. średnica rury	L [mm]	
55100	1" (25 mm)	330	12/36
55150	1-1/2" (38 mm)	390	10/20
55200	2" (50 mm)	540	6/12

EN Adjustable pipe wrench
 PL Klucz nastawny do rur
 DE Rohrschlüssel
 RU Ключ трубный
 CS Nastavitelný klíč na trubky
 RO Cheie reglabilă pt. țevi
 HU Állítható csőkulcs
 ES Llave de vaso para tubería

90°



VOREL

No.	Max. pipe diameter / Maks. średnica rury	L [mm]	
55215	1" (25 mm)	310	24
55216	1-1/2" (38 mm)	420	1/16
55217	2" (50 mm)	560	1/8

EN Pipe wrench
 PL Klucz do rur
 DE Rohrschlüssel
 RU Ключ трубный
 CS Klíč součásti na trubky
 RO Chei pt. țevi
 HU Csőkulcs
 ES Llave de fontanero



VOREL

No.	L [mm]	
55620	195	6/36
55625	245	6/30
55630	275	6/24
55635	310	6/18
55645	395	4/12
55660	490	2/6
55690	750	2/4

EN Adjustable pipe wrench
 PL Klucz nastawny do rur
 DE Rohrschlüssel
 RU Ключ трубный
 CS Nastavitelný klíč na trubky
 RO Cheie reglabilă pt. țevi
 HU Állítható csőkulcs
 ES Llave de vaso para tubería

45°



VOREL

No.	Max. pipe diameter / Maks. średnica rury	L [mm]	
55210	1" (25 mm)	320	1/24
55211	1-1/2" (38 mm)	425	1/16
55212	2" (50 mm)	560	1/8

EN Adjustable pipe wrench
 PL Klucz nastawny do rur
 DE Rohrschlüssel
 RU Ключ трубный
 CS Nastavitelný klíč na trubky
 RO Cheie reglabilă pt. țevi
 HU Állítható csőkulcs
 ES Llave de vaso para tubería

S



VOREL

No.	Max. pipe diameter / Maks. średnica rury	L [mm]	
55220	1" (25 mm)	315	1/24
55221	1-1/2" (38 mm)	425	1/16
55222	2" (50 mm)	560	1/8

EN Adjustable wrench
 PL Klucz nastawny francuski
 DE Stahlschraubenschlüssel /franzose/
 RU Ключ разводной

CS Nastavitelný klíč francúz
 RO Cheie reglabilă franceză
 HU Állítható franciakułcs
 ES Llave ajustable inglesa



No.	Jaws opening capacity / Zakres rozwarcia szczęk [mm]	Jaws width / Szerokość szczęk [mm]	
54497	0-25	60	10
54498	0-35	70	10
54499	0-45	80	10
54500	0-55	90	5
54510	0-65	100	5

EN Chain pipe wrench
 PL Klucz łańcuchowy do rur
 DE Kettenrohrzange
 RU Ключ цепной для труб
 CS Klíč řetězový na trubky
 RO Cheie reglabila pt. tevi cu lant
 HU Láncos csőfogó
 ES Llave de cadena

300 mm

485 mm

4" 100mm

INDUCTION HARDENED TEETH ZĘBY HARTOWANE INDUKCYJNIE



4



No.	Max. cutting diameter / Maks. średnica cięcia	L [mm]	
55792	4" (100.0 mm)	300	10/30

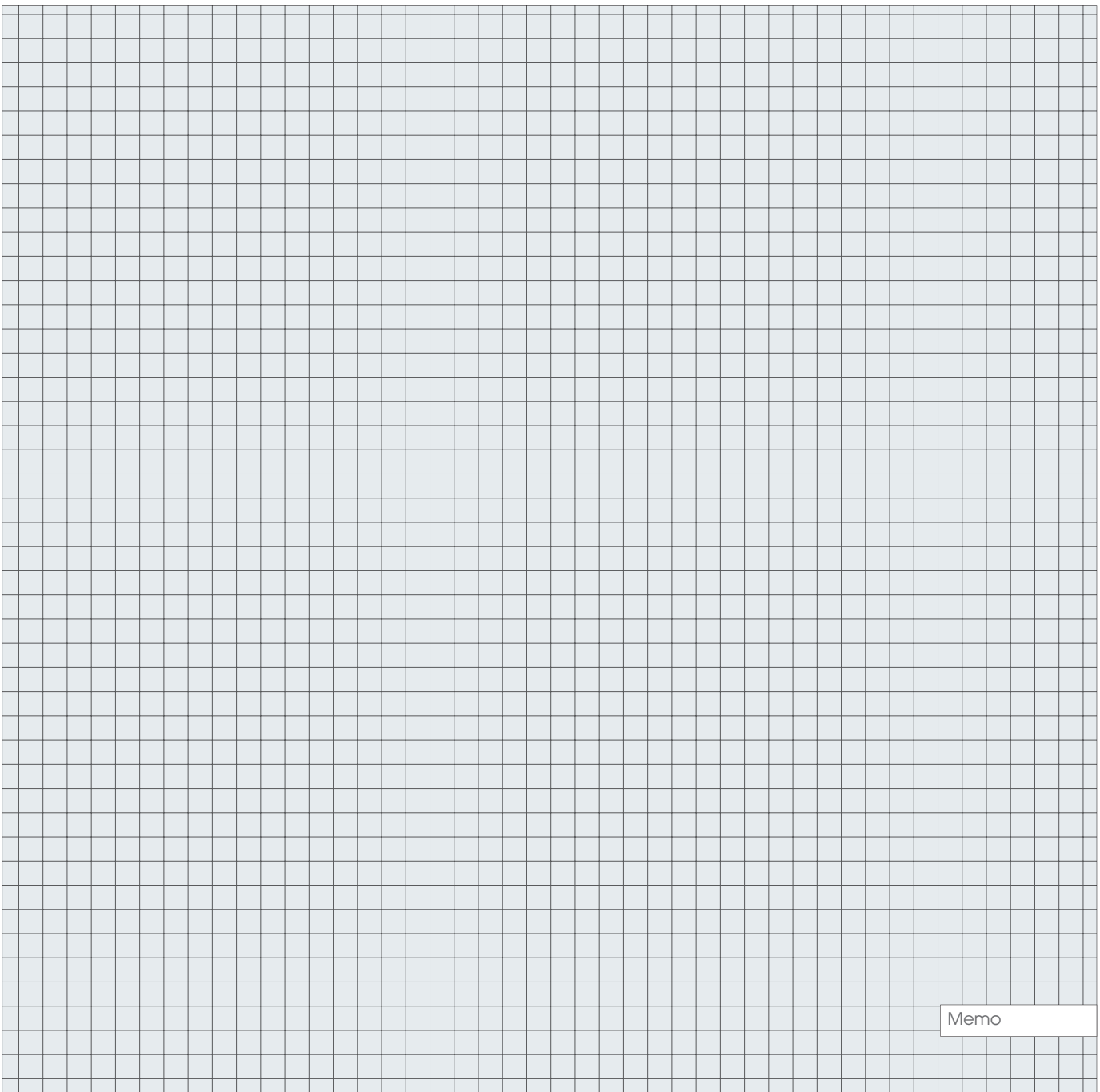

Memo

5

Electrician tools Narzędzia dla elektryków

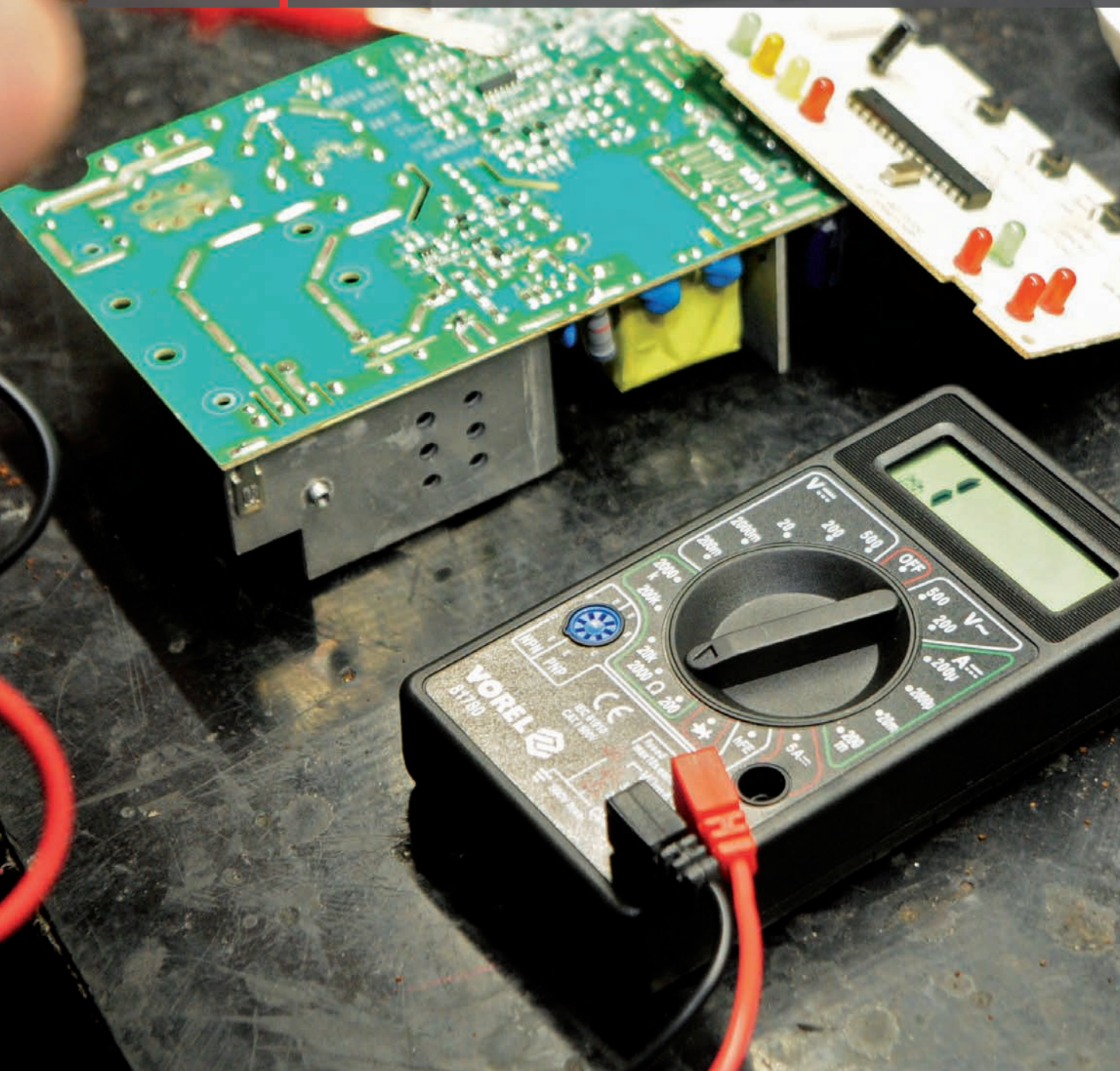

Crimping pliers
Szczypce do zaciskania
konektorów

.....56



Wire strippers
Ściągacze izolacji

.....56-57



Electrical cutters
Obcinaki elektryczne

.....57-58



Voltage testers
Próbniki napięcia

.....58



Digital universal meters
Cyfrowe mierniki uniwersalne

.....58-59



- EN Ratchet crimping pliers
- PL Szczypce do zaciskania konektorów
- DE Kabelschuhzange
- RU Клещи для опрессовки наконечников
- CS Kleště pro svěření zaciskania konektorů
- RO Clește sertizat conectori
- HU Krimpelő fogó
- ES Pinzas de apretar de conectores



No.	mm ²	AWG	
45500	0.5-2.5	20-14	12/36

- EN Ratchet crimping pliers
- PL Szczypce do zaciskania konektorów
- DE Kabelschuhzange
- RU Клещи для опрессовки наконечников
- CS Kleště pro svěření zaciskania konektorů
- RO Clește sertizat conectori
- HU Krimpelő fogó
- ES Pinzas de apretar de conectores

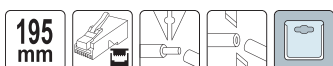

No.	RJ	
45504	RJ45, RJ10, RJ11, 8P, 6P, 4P	10/50

- EN Solderless terminal kit
- PL Zaciskacz z konektorami w kasie
- DE Kabelschuhzange u. Kabelschuhe
- RU Клещи для бжима + изолированные наконечники
- CS Svěřka z konektorama v kazetě
- RO Set cleste mufare plus conectori
- HU Présszerszám csatlakozókkal egy dobozban
- ES Apretador con conectores en caja



No.	mm ²	AWG	mm ²	AWG	pcs / szt.	
45050	1.5-6.0	22-10	1.5-6.0	22-10	100	25/50

- EN Ratchet crimping pliers
- PL Szczypce do zaciskania konektorów
- DE Kabelschuhzange
- RU Клещи для опрессовки наконечников
- CS Kleště pro svěření zaciskania konektorů
- RO Clește sertizat conectori
- HU Krimpelő fogó
- ES Pinzas de apretar de conectores



No.	RJ	
45503	RJ45, RJ11	10/40

- EN Wire stripper
- PL Ściągacz izolacji
- DE Abisolierzange
- RU Съёмник изоляции
- CS Odizolovací klejte
- RO Decablator
- HU Blankoló fogó
- ES Extractor de aislado

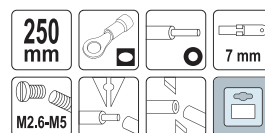

No.	mm ²	AWG	mm ²	AWG	
45000	1.5-6.0	22-10	0.75-6.0	22-10	12/120

- EN Wire stripper
- PL Ściągacz izolacji
- DE Abisolierzange
- RU Съёмник изоляции
- CS Odizolovací klejte
- RO Decablator
- HU Blankoló fogó
- ES Extractor de aislado

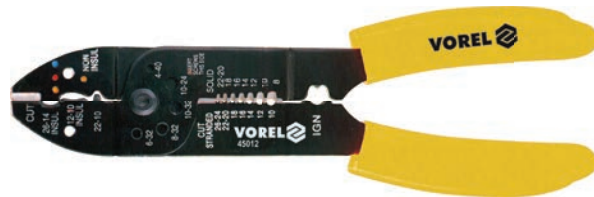

No.	mm ²	AWG	mm ²	AWG	mm ²	AWG	
45012	0.64-2.6	26-10	0.8-2.6	22-10	0.64-2.6	26-10	12/72

EN Wire stripper
 PL Ściągacz izolacji
 DE Abisolierzange
 RU Съёмник изоляции
 CS Odizolovací klejte
 RO Decablator
 HU Blankoló fogo
 ES Extractor de aislado

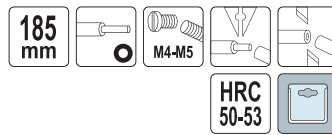

No.	mm ²	AWG	Box
45010	0.8-2.6	22-10	12/120

EN Wire stripper / crimper
 PL Automacyjny ściągacz izolacji
 DE Automatische Abisolierzange
 RU Клещи для удаления изоляции
 CS Automatický stahovač izolace
 RO Clește automat desizolat
 HU Automatikus szigeteléslehúzó
 ES Pelacables automatico

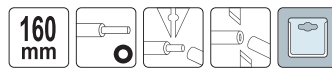

No.	mm ²	AWG	Box
45151	1.0-3.2	17-12	10/40

EN Automatic wire stripper with cutter
 PL Automacyjny ściągacz z obcinakiem
 DE Automatische Abisolierzange + Schneider
 RU Клещи-автомат для снятия изоляции
 CS Automatický stahovač izolace
 RO Decablator automat
 HU Automatikus szigeteléslehúzó
 ES Pelacables automatico

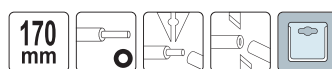

No.	mm ²	AWG	Box
45201	0.5-4.0	20-13	10/50

EN Wire stripper / crimper
 PL Automacyjny ściągacz izolacji
 DE Automatische Abisolierzange
 RU Клещи для удаления изоляции
 CS Automatický stahovač izolace
 RO Clește automat desizolat
 HU Automatikus szigeteléslehúzó
 ES Pelacables automatico

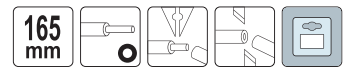

No.	mm ²	AWG	Box
45100	0.5-6.0	20-10	20/100

EN Universal wire stripper
 PL Uniwersalny ściągacz izolacji
 DE Universal Abisolierzange
 RU Универсальный съёмник изоляции
 CS Univerzální odizolovací klejte
 RO Decablator universal
 HU Blankoló fogo
 ES Extractor de aislado universal

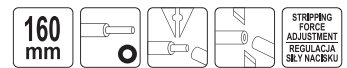

No.	mm ²	AWG	Box
45160	0.25	30	10/40

EN Electrical cutter
 PL Obcinak elektryczny
 DE Seitenschneider
 RU Шипцы для резки проводов
 CS Elektrické upichovávky ze stahovadlem
 RO Clește tăietor electrician
 HU Kábelvágó
 ES Cortacables eléctricos

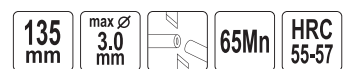

No.	L [mm]	Box
45020	135	12/120

5

- EN Electrician scissors
- PL Nożyczki dla elektryków
- DE Elektrische Schere
- RU Ножницы универсальные
- CS Elektrické nůžky
- RO Foarfece - electrician
- HU Univerzális olló
- ES Tijeras eléctricos

140 mm SS2Cr13 PP



No.	L [mm]	
76320	140	12/120

- EN Voltage tester
- PL Próbnik napięcia
- DE Spannungsprüfer
- RU Отвёртка индикаторная
- CS Zkoušeč napětí
- RO Creion de tensiune
- HU Fáziskereső
- ES Comprobador de corriente

190 mm 125-250 V~



No.	L [mm]	
65235	190	12/600

- EN Digital universal multimeter
- PL Cyfrowy miernik uniwersalny
- DE Digital-Multimeter
- RU Универсальный цифровой измеритель
- CS Digitální multimetr univerzální
- RO Multimetru digital universal
- HU Digitális multiméter
- ES Manómetro digital universal

LCD 1999 0-600V A.C. 0-600V D.C. 0-10 A A.C. 0-10 A D.C. 0-200 MΩ 0-20 μF 0-20 kHz hFE PNP NPN DATA HOLD 9 V



No.	Digit height / Wysokość cyfr [mm]	
81783	25	20

- EN Voltage tester
- PL Próbnik napięcia
- DE Spannungsprüfer
- RU Отвёртка индикаторная
- CS Zkoušeč napětí
- RO Creion de tensiune
- HU Fáziskereső
- ES Comprobador de corriente

140 mm 125-250 V~



No.	L [mm]	
65233	140	12/1200

- EN Digital universal multimeter
- PL Cyfrowy miernik uniwersalny
- DE Digital-Multimeter
- RU Универсальный цифровой измеритель
- CS Digitální multimetr univerzální
- RO Multimetru digital universal
- HU Digitális multiméter
- ES Manómetro digital universal

LCD 1999 0-500V A.C. 0-500V D.C. 0-5 A D.C. 0-2 MΩ hFE PNP NPN 9 V



No.		
81780		12/72

- EN Digital universal multimeter
- PL Cyfrowy miernik uniwersalny
- DE Digital-Multimeter
- RU Универсальный цифровой измеритель
- CS Digitální multimetr univerzální
- RO Multimetru digital universal
- HU Digitális multiméter
- ES Manómetro digital universal

LCD 1999 0-600V A.C. 0-600V D.C. 0-10 A A.C. 0-10 A D.C. 0-200 MΩ 0-20 μF 0-20 kHz °C -40 +40 hFE PNP NPN DATA HOLD 9 V



No.	Digit height / Wysokość cyfr [mm]	
81784	25	20

EN Digital universal multimeter
 PL Cyfrowy miernik uniwersalny
 DE Digital-Multimeter
 RU Универсальный цифровой измеритель
 CS Digitální multimetr univerzální
 RO Multimetru digital universal
 HU Digitális multiméter
 ES Manómetro digital universal



LCD 1999	0-600V A.C.	0-600V D.C.
0-10 A D.C.	0-2 MΩ	h _{FE} PNP NPN
▶	•••	DATA HOLD
LED BACKLIGHT PODSWETLENIE	9 V 6F22!	☐



No.	☐
81773	50

EN Digital universal multimeter
 PL Cyfrowy miernik uniwersalny
 DE Digital-Multimeter
 RU Универсальный цифровой измеритель
 CS Digitální multimetr univerzální
 RO Multimetru digital universal
 HU Digitális multiméter
 ES Manómetro digital universal



LCD 1999	0-750V A.C.	0-1000V D.C.
0-20 A A.C.	0-20 A D.C.	0-200 MΩ
0-200 μF	h _{FE} PNP NPN	▶
•••	DATA HOLD	ADJUSTABLE DISPLAY REGULOWANY WYŚWIETLACZ
AUTO POWER OFF AUTOMATYCZNE WYŁĄCZANIE	9 V 6F22!	☐



No.	☐
81775	40

EN Digital universal multimeter
 PL Cyfrowy miernik uniwersalny
 DE Digital-Multimeter
 RU Универсальный цифровой измеритель
 CS Digitální multimetr univerzální
 RO Multimetru digital universal
 HU Digitális multiméter
 ES Manómetro digital universal



LCD 1999	0-500V A.C.	0-500V D.C.
0-10 A D.C.	0-20 MΩ	▶
•••	1.5V 9V 12V BATTERY TEST TEST BATERII	DATA HOLD
LED BACKLIGHT PODSWETLENIE	9 V 6F22!	☐



No.	☐
81774	50

EN Clamp universal multimeter
 PL Cęgowy miernik uniwersalny
 DE Universal Zangenamperemeter
 RU Универсальный цифровой измеритель
 CS Digitální multimetr univerzální
 RO Multimetru digital universal
 HU Digitális multiméter
 ES Manómetro digital universal



LCD 1999	0-450V A.C.
0-600V D.C.	0-400A A.C.
0-200 KΩ	▶
•••	DATA HOLD
2x AAA	☐



No.	☐
81801	5/60

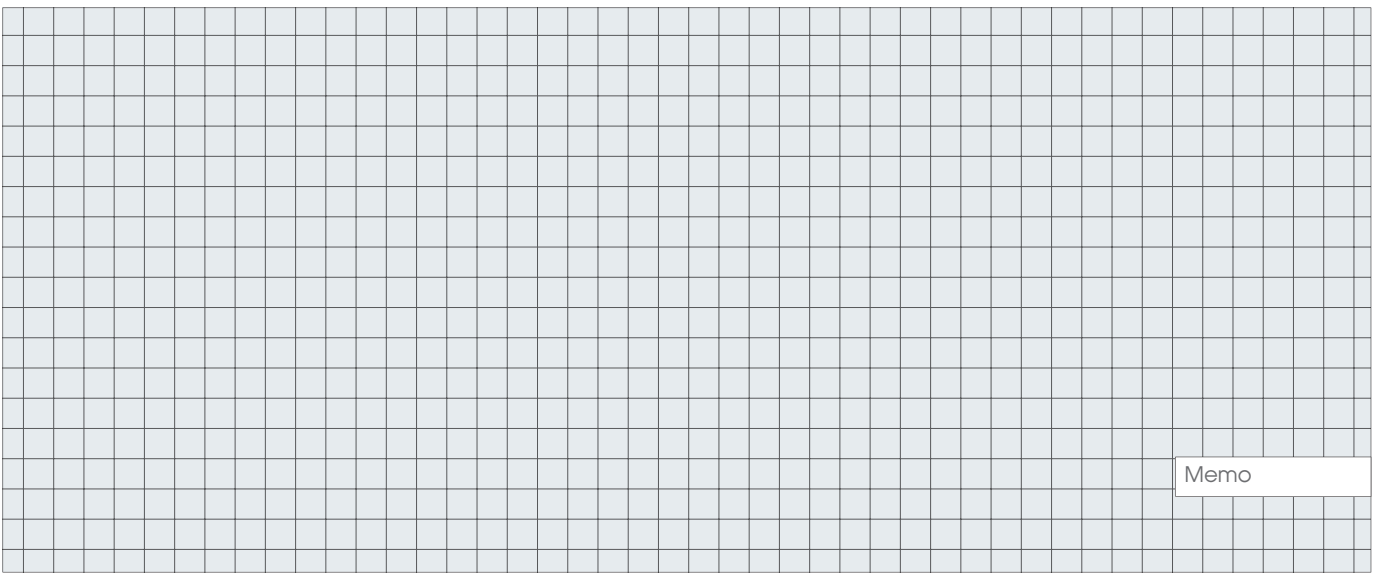

Memo

5

6

Hammers, chisels, punches & axes Młotki, dłuta, przecinaki i siekiery



Machinist hammers Młotki ślusarskie



62-63

Machinist hammers with wooden handle

Młotki ślusarskie z rączką drewnianą 62

Machinist hammers with fibreglass handle

Młotki ślusarskie z rączką z włókna szklanego 62

Machinist hammers „Juco”

Młotki ślusarskie „Juco” 62

Brick hammers „Juco”

Młotki murarskie „Juco” 63

Welder’s hammers „Juco”

Młotki spawalnicze „Juco” 63

Stoning hammers Młotki kamieniarskie



63

Stoning hammers „Juco”

Młotki kamieniarskie „Juco” 63

Hammers with tubular steel handle Młotki z trzonkiem rurowym



63-64

Claw hammers

Młotki szewskie 63

Roofing hammers

Młotki ciesielskie 63

Mason’s hammers

Młotki murarskie 64

Hammers with fibreglass handle Młotki z rączką z włókna szklanego



64

Claw hammers

Młotki szewskie 64

Roofing hammers

Młotki ciesielskie 64

Rubber mallets Młotki gumowe



64-65

Rubber mallets with wooden handle

Młotki gumowe z rączką drewnianą 64

Rubber mallets with tubular steel handle

Młotki gumowe z rączką stalową 64

Rubber mallets with fibreglass handle

Młotki gumowe z rączką z włókna szklanego 64

Soft faced mallets

Młotki blacharskie gumowo-plastykowe 65

Wooden mallets Młotki drewniane



65

Chisels, cold chisels, punches & wrecking bars

Dłuta, przecinaki, przebijaki i łomy



65-67

Wood chisels with wooden handle

Dłuta stolarskie z rączką drewnianą 65

Wood chisels with plastic handle

Dłuta stolarskie z rączką z tworzywa 65

Curving chisels

Dłuta snycerskie 65

Cold chisels

Przecinaki 66

Cold chisels „Juco”

Przecinaki „Juco” 66

Punches

Przebijaki 66

Wrecking bars

Łomy 67

Wrecking bars „Juco”

Łomy „Juco” 67

Axes Siekiery



68-69

Axes with wooden handle

Siekiery z trzonkiem drewnianym 68

Axes with fibreglass handle

Siekiery z trzonkiem z włókna szklanego 68

Axes „Juco”

Siekiery „Juco” 68

Hammer and axe wedges

Zestawy klinujące do młotków i siekier 69

Picaxes Kilofy



70

Pickaxes

Kilofy 70

Wood splitters „Juco”

Kliny do rozłupywania drewna „Juco” 70

EN Machinist hammer
 PL Młotek ślusarski
 DE Schlosserhammer
 RU Молоток слесарный

CS Zámečnické kladívko
 RO Ciocan de lăcătușerie
 HU Vaskalapács
 ES Martillo



No.	m [g]	
30010	100	12/120
30020	200	12/72
30030	300	12/60
30040	400	6/48
30050	500	6/36
30060	600	6/36
30080	800	6/24
30100	1000	6/24
30150	1500	6/12
30200	2000	6/12

EN Machinist hammer
 PL Młotek ślusarski
 DE Schlosserhammer
 RU Молоток слесарный

CS Zámečnické kladívko
 RO Ciocan de lăcătușerie
 HU Vaskalapács
 ES Martillo

DIN 1042



No.	m [kg]	
30531	3	1
30532	4	1
30533	5	1
30534	6	1
30535	8	1
30536	10	1

EN Machinist hammer
 PL Młotek ślusarski
 DE Schlosserhammer
 RU Молоток слесарный

CS Zámečnické kladívko
 RO Ciocan de lăcătușerie
 HU Vaskalapács
 ES Martillo

DIN 1041



JUCO

No.	m [g]	
31010	100	10
31030	300	10
31050	500	10
31070	700	10
31100	1000	10
31150	1500	6
31200	2000	6

EN Machinist hammer
 PL Młotek ślusarski
 DE Schlosserhammer
 RU Молоток слесарный

CS Zámečnické kladívko
 RO Ciocan de lăcătușerie
 HU Vaskalapács
 ES Martillo



VOREL

No.	m [g]	
30410	100	6/120
30420	200	6/60
30430	300	6/60
30440	400	6/48
30450	500	6/36
30460	600	6/36
30480	800	6/24
30500	1000	6/24
30510	1500	6/12
30520	2000	6/12

EN Machinist hammer with fibreglass + PVC handle
 PL Młotek ślusarski, rączka z włókna szklanego
 DE Schlosserhammer Fiberglasstiel
 RU Молоток со стеклопластиковой ручкой

CS Zámečnické kladívko
 RO Ciocan de lăcătușerie
 HU Vaskalapács
 ES Martillo



VOREL

No.	m [g]	
30310	100	6/120
30320	200	6/36
30330	300	6/36
30340	400	6/36
30350	500	6/36
30360	600	6/36
30380	800	6/24
30390	1000	6/24
30395	1500	6/12
30400	2000	6/12

EN Machinist hammer
 PL Młotek ślusarski
 DE Schlosserhammer
 RU Молоток слесарный

CS Zámečnické kladívko
 RO Ciocan de lăcătușerie
 HU Vaskalapács
 ES Martillo

DIN 1042



JUCO

No.	m [g]	
31300	3000	1
31400	4000	1
31500	5000	1
31600	6000	1
31800	8000	1
32000	10000	1

EN Machinist hammer
 PL Młotek ślusarski
 DE Schlosserhammer
 RU Молоток слесарный

CS Zámečnické kladívko
 RO Ciocan de lăcătușerie
 HU Vaskalapács
 ES Martillo



JUCO

No.	m [g]	
29992	300	5
29993	500	5
29994	700	5
29995	1000	5
29996	1500	5
29997	2000	5

EN Welder's hammer
 PL Młotek spawalnicy
 DE Schweisserhammer
 RU Молоток сварщика

CS Svářečské kladívko
 RO Ciocan de sudură
 HU Hegesztő kalapács
 ES Martillo para soldar



JUCO

No.	m [g]	
32110	350	5

EN Claw hammer with tubular steel handle
 PL Młotek szewski, rączka ze stali
 DE Klauenhammer
 RU Молоток-гвоздодел с металлической обрезиненной рукояткой
 CS Ševcovské kladívko
 RO Ciocan de cizmărie
 HU Cipész kalapács
 ES Martillo sacador mango de acero



VOREL

No.	m [g]	
32625	600	6/24

EN Brick hammer
 PL Młotek murarski
 DE Maurerhammer
 RU Молоток каменщика
 CS Zednické kladívko
 RO Ciocan de zidărie
 HU Kőműves kalapács
 ES Martillo albañil



JUCO

No.	m [g]	
32720	700	5

EN Safety stoning hammer
 PL Młotek kamieniarski
 DE Fäustel
 RU Кувалда двухбухвая

CS Palička kovová
 RO Ciocan pt. zidarie
 HU Kőtörő kalapács
 ES Martillo



JUCO

No.	m [g]	
32201	1500	6
32202	2000	6
32203	3000	1
32204	4000	1
32205	5000	1
32206	6000	1
32207	8000	1
32208	10000	1

EN Roofing hammer with tubular steel handle
 PL Młotek ciesielski, rączka ze stali
 DE Lattenhammer
 RU Молоток кровельщика
 CS Tesařské kladívko
 RO Ciocan de dulgherie
 HU Ácskalapács
 ES Martillo sacador mango de acero



VOREL

No.	m [g]	
32685	600	6/24

EN Mason's hammer type „B” with tubular steel handle
PL Młotek murarski berliński, rączka ze stali
DE Berliner Mauerhammer
RU Молоток каменщика

CS Zednické kladívko berlínské
RO Ciocan de zidărie tip Berlin
HU Kőműves kalapács, berlini típus
ES Martillo berlin mango de acero



VOREL

No.	m [g]	
32705	600	6/24

6

EN Claw hammer
PL Młotek szewski
DE Klauenhammer
RU Молоток-гвоздодер
CS Kladivo ševcovské
RO Cican pt. cismani
HU Cipész kalapács
ES Martillo sacador



VOREL

No.	m [g]	
32627	600	6/24

EN Rubber mallet
PL Młotek gumowy
DE Gummihammer
RU Киянка резиновая

CS Pryžové kladívko
RO Ciocan de cauciuc
HU Gumikalapács
ES Mazo de goma



No.	Head diameter / Šrednica obucha [mm]	
33550	45	36/72
33650	55	12/60
33900	70	12/24

EN Rubber mallet with fibreglass + PVC handle
PL Młotek gumowy, rączka z włókna szklanego
DE Gummihammer Fibreglasstiel
RU Киянка резиновая с фиберглассовой ручкой

CS Pryžové kladívko
RO Ciocan de cauciuc
HU Gumikalapács
ES Mazo de goma



VOREL

No.	Head diameter / Šrednica obucha [mm]	
33535	45	12/48
33555	50	6/48
33655	56	6/30
33905	66	6/24
33925	76	6/18

EN Mason's hammer type „R” with tubular steel handle
PL Młotek murarski reński, rączka ze stali
DE Maurerhammer rheinische Form
RU Молоток каменщика

CS Zednické kladívko renské
RO Ciocan de zidărie
HU Kőműves kalapács, rajnai típus
ES Martillo rin mango de acero



VOREL

No.	m [g]	
32715	600	6/24

EN Roofing hammer with fibreglass + PVC handle
PL Młotek ciesielski, rączka z włókna szklanego
DE Lattenhammer Fibreglasstiel
RU Молоток кровельщика
CS Kladivo tesařské, ručka ze skleněných vláken
RO Ciocan de dulgherie
HU Ácskalapács
ES Martillo de carpintero con mango de fibra de vidrio



VOREL

No.	m [g]	
32687	600	6/24

EN Rubber mallet with steel handle
PL Młotek gumowy z rączką stalową
DE Gummihammer Stahlstiel
RU Киянка резиновая

CS Pryžové kladívko
RO Ciocan de cauciuc
HU Gumikalapács
ES Mazo de goma



VOREL

No.	Head diameter / Šrednica obucha [mm]	
33557	50	12/60
33657	56	12/48
33907	66	6/24

EN Rubber mallet with fibreglass + PVC handle
PL Młotek gumowy, rączka z włókna szklanego
DE Gummihammer Fibreglasstiel
RU Киянка резиновая с фиберглассовой ручкой



EN Soft faced mallet
 PL Młotek blacharski, guma - plastik
 DE Ausbeulhammer
 RU Молоток рихтовочный комбинированный с деревянной ручкой

CS Klempířské kladívko
 RO Ciocan pt. tabla
 HU Bádogos kalapács
 ES Mazo goma-plástico

35 mm



No.	Head diameter / Šířka obucha [mm]	
33950	35	30/60

EN Wooden mallet
 PL Młotek drewniany blacharski
 DE Holzhammer für Bleche
 RU Молоток жестящика, деревянный

CS Palice dřevěná klempířská
 RO Ciocan din lemn de tinichigiu
 HU Bádogos fakalapács
 ES Martillo de madera de hojalatero



No.	L [mm]	
33532	285	20

EN Chisel
 PL Dłuto
 DE Stechbeitel
 RU Стамеска с ударной головкой
 CS Rezbářské dláto
 RO Dalță de tâmplărie
 HU Asztalos véső
 ES Cíncel con mango transparente



No.	Size / Rozmiar [mm]	
25510	6	5/60
25511	8	5/60
25512	10	5/60
25513	12	5/60
25514	14	5/60
25515	15	5/60
25516	18	5/60
25517	20	5/60
25518	22	5/60
25519	25	5/60
25520	32	5/60
25521	38	5/60

EN Carpenter's wooden mallet
 PL Młotek drewniany stolarski
 DE Tischlerhammer aus Holz
 RU Молоток деревянный столярный

CS Palice dřevěná stolařská
 RO Ciocan din lemn de tâmplar
 HU Asztalos fakalapács
 ES Martillo de madera de carpintero



No.	L [mm]	
33530	320	20

EN Wood chisel set
 PL Zestaw dłut stolarskich
 DE Stech-Beitelsatz
 RU Набор стамесок

CS Zámečnické dláta
 RO Dalte de tâmplărie
 HU Asztalos véső
 ES Cinceles de carpintero

4 PCS



No.	pcs / szt.	
25500	4	10/40

EN Wood chisel set
 PL Zestaw dłut do drewna
 DE Stechbeitelsatz
 RU Набор стамесок по дереву

CS Zámečnické dláta
 RO Set dalți
 HU Asztalos véső
 ES Juego de cinceles

4 PCS



No.	Size / Rozmiar [mm]	pcs / szt.	
25530	6, 12, 18, 24	4	10/40

EN Curving chisel set
 PL Zestaw dłut snycerskich
 DE Holzschnittwerkzeugsatz
 RU Набор фигурных стамесок для резьбы по дереву
 CS Rezbářské dláta
 RO Dalte curbate cu mâner din lemn
 HU Finom véső
 ES Cinceles mango de madera

6 PCS



No.	pcs / szt.	
25700	6	15/60

EN Octagonal cold chisel with protection
PL Przecinak płaski z osłoną
DE Flachmeissel mit Handschutz
RU Зубило с протектором

CS Plochý sekáč /z krytem/
RO Dalta zidarie cu protectie
HU Hidegvágó /lapos /védőfejjel/
ES Cincel plano /con protector/



6

No.	W [mm]	L [mm]	
35250	20	250	12/72
35300	25	300	12/48

EN Cold chisel with protection
PL Przecinak z osłoną
DE Flachmeissel mit Handschutz
RU Зубило с протектором
CS Sekáč /z krytem/
RO Dalta cu protectie
HU Hidegvágó /védőfejjel/
ES Cincel /con protector/



VOREL

No.	Thickness / Grubość [mm]	W [mm]	L [mm]	
35450	18	50	215	6/36
35451	19	75	215	6/36
35452	25	100	215	6/36

EN Octagonal point chisel with protection
PL Przebijak murarski z osłoną
DE Spitzmeissel mit Handschutz
RU Керн с протектором
CS Sekáč zednický s ochranným
RO Dorn cu protectie pt. constructii
HU Falvész kézvédővel
ES Cincel de cerrajería con protector

300 mm



No.	L [mm]	
35430	300	12/48

EN Cold chisel with protection
PL Przecinak z osłoną
DE Flachmeissel mit Handschutz
RU Зубило с протектором

CS Sekáč /z krytem/
RO Dalta cu protectie
HU Hidegvágó /védőfejjel/
ES Cincel /con protector/



VOREL

No.	W [mm]	L [mm]	
35351	25	300	12/36
35352	25	350	10/30
35353	25	400	12/24
35355	25	500	5/20

EN Forged cold chisel
PL Przecinak ślusarski
DE Flachmeissel
RU Зубило слесарное

CS Zámečnický sekáč
RO Dalta forjată pt. metal
HU Lakatos hidegvágó
ES Cincel de cerrajería



JUCO

No.	Thickness / Grubość [mm]	W [mm]	L [mm]	m [kg]	
35372	10	20	200	0.25	10
35373	12	23	250	0.46	10
35374	12	23	300	0.53	10
35376	10	30	400	0.90	10

EN Forged cold chisel with protection
PL Przecinak murarski z osłoną
DE Meissel mit Handschutz
RU Зубило с протектором

CS Zámečnický sekáč /z krytem/
RO Dalta forjată cu protectie
HU Fém hidegvágó, kézvédővel
ES Cincel de cerrajería mm con protector



JUCO

No.	Thickness / Grubość [mm]	L [mm]	m [kg]	
35359	17	250	0.56	5
35360	17	300	0.65	5
35362	17	350	0.76	5
35364	19	400	1.00	5
35366	19	450	1.13	5
35368	19	500	1.22	5

EN Wrecking bar CS Páčidlo
 PL Łom RO Ranga
 DE Nageleisen HU Szögkihúzó
 RU Лом ES Palanqueta



VOREL

No.	W [mm]	L [mm]	
34243	18	500	5/10
34245	18	700	10
34247	18	1000	10

EN Square type wrecking bar
 PL Łom kwadratowy, hartowane końcówki
 DE Nageleisen gehärtete Spitze
 RU Лом квадратный с закаленными концами
 CS Páčidlo hranaté, kalené konce
 RO Ranga patrata
 HU Négyzetű keresztmetszetű feszítővas, edzett véggel
 ES Palanqueta



VOREL

No.	Thickness / Grubość [mm]	W [mm]	L [mm]	
34254	12	22	400	12/24
34256	16	30	600	6/12

EN Wrecking bar CS Páčidlo
 PL Łom RO Ranga pt. scos cuie
 DE Nageleisen HU Szögkihúzó
 RU Лом-гвоздоде́р ES Palanqueta



No.	L [mm]	
34600	600	24
34750	750	24
34900	900	24

EN Wrecking bar CS Stavební páčidlo
 PL Łom budowlany RO Ranga Profi
 DE Baubrechstange HU Szögkihúzó
 RU Лом круглый ES Palanqueta de obra



JUCO

No.	Ø [mm]	L [mm]	m [kg]	
34220	27	1000	3.6	1
34222	27	1200	4.8	1
34225	27	1500	5.7	1

EN Flat wrecking bar CS Páčidlo ploché kalené
 PL Łom płaski hartowany RO Ranga plata
 DE Nageleisen gehärtete Spitze HU Lapos feszítővas
 RU Лом плоский закаленный ES Palanca plana



VOREL

No.	Thickness / Grubość [mm]	W [mm]	L [mm]	
34251	6	35	450	6/24

EN Wrecking bar CS Páčidlo
 PL Łom RO Ranga pt. scos cuie
 DE Nageleisen HU Szögkihúzó
 RU Лом-гвоздоде́р ES Palanca



No.	L [mm]	
34300	300	60

EN Wrecking bar CS Šestiúhlé páčidlo
 PL Łom sześciokątny RO Ranga pt. scos cuie Profi
 DE Brechstange HU Hatszögű feszítővas
 RU Лом-гвоздоде́р шестигранный ES Palanqueta



JUCO

No.	Thickness / Grubość [mm]	L [mm]	m [kg]	
34204	17	400	0.82	5
34205	17	500	1.1	5
34206	17	600	1.2	5
34207	17	700	1.4	5
34208	17	800	1.6	5
34210	19	1000	2.5	5
34212	19	1200	3	5



EN Drop forged hatchet CS Sekera ocelová kovaná
 PL Siekiera ze stali kutej RO Toporişca lama forjată
 DE Handbeil HU Kovácsolt acél fejűse
 RU Топор кованый ES Hacha de metalo forjado



FLO

No.	m [g]	
33080	800	12/24

EN Axe CS Sekyrka
 PL Siekiera RO Toporişca
 DE Handbeil HU Szekerce
 RU Топор ES Hacha



FLO

No.	m [g]	
33067	600	24
33087	800	20
33107	1000	12
33127	1250	12
33147	1400	12
33177	1600	12

EN Axe CS Sekyrka
 PL Siekiera RO Toporişca
 DE Handbeil HU Szekerce
 RU Топор ES Hacha

DIN
5131
7294



JUCO

No.	m [g]	DIN	
33024	400	5131	5
33026	600	5131	5
33028	800	5131	5
33030	1000	5131	5
33032	1250	7294	5
33035	1500	7294	5
33038	1800	7294	5
33039	2000	7294	5
33040	2500	7294	5

EN Axe CS Sekera
 PL Siekiera RO Secure
 DE Handbeil HU Szekerce
 RU Топор ES Hacha



FLO

No.	m [g]	
32930	1000	10

EN Axe with fibreglass + PVC handle CS Sekyrka
 PL Siekiera, rączka z włókna szklanego RO Toporişca cu coada din fibra de sticlă
 DE Handbeil Fiberglasstiel HU Szekerce
 RU Топор с фиберглассовой ручкой ES Hacha con mango de fibra de vidrio



VOREL

No.	m [g]	
33065	600	20
33085	800	20
33105	1000	12
33125	1250	6

EN Axe CS Sekyrka
 PL Siekiera RO Toporişca
 DE Handbeil HU Szekerce
 RU Топор ES Hacha

DIN
5131
7294



JUCO

No.	m [g]	DIN	
33000	400	5131	5
33001	600	5131	5
33002	800	5131	5
33003	1000	5131	5
33004	1250	7294	5
33005	1500	7294	5
33006	1800	7294	5
33007	2000	7294	5
33008	2500	7294	5

EN Axe set
 PL Zestaw siekier tradycyjnych
 DE Satz traditioneller Äxte
 RU Набор традиционных топоров

CS Sada klasičických seker
 RO Set topoare
 HU Hagymányos balta készlet
 ES Set de hechas tradicionales



JUCO

No.	m [kg]	
32999	0.4, 1.5	5

EN Hammer-axe for wood splitting
 PL Siekiero-młot
 DE Spaltaxt
 RU Топор-колун

CS Sekera-kladivo
 RO Secure-ciocan
 HU Szekerce-kalapács
 ES Hacha martillo para partir madera



JUCO

No.	m [kg]	
32927	2.1	1
32928	3.2	1

EN Canadian axe
 PL Siekiera kanadyjska
 DE Handbeil „Kanadische Form“
 RU Топор канадского типа

CS Sekera kanadská
 RO Topor canadian
 HU Hosszú nyelű, hasító fejsze
 ES Hacha canada

1.8 kg



JUCO

No.	m [kg]	
33022	1.8	5

EN Hammer wedges
 PL Zestaw klinujących
 DE Keilesatz
 RU Набор клинов
 CS Sada klínků
 RO Set cultivator
 HU Ékelő készlet
 ES Juego de sujeción



JUCO

No.	For hammer / Do mlotka [kg]	For axe / Do siekiery	
99460	0.1-0.5	-	50
99461	0.7-2.0	-	50
99462	3.0-4.0	0.4	50

EN Axe
 PL Siekiera z klinem
 DE Handbeil
 RU Топор

CS Sekerka
 RO Secure
 HU Szekerce
 ES Hacha



JUCO

No.	m [kg]	
32924	2	5

EN Hammer-axe for wood splitting
 PL Siekiero-młot
 DE Spaltaxt
 RU Топор-колун

CS Sekera-kladivo
 RO Secure-ciocan
 HU Szekerce-kalapács
 ES Hacha martillo para partir madera



JUCO

No.	m [kg]	
32925	2.5	1
32926	4.0	1

EN Hammer wedges
 PL Zestaw klinujących
 DE Keilesatz
 RU Набор клинов

CS Sada klínků
 RO Set cultivator
 HU Ékelő készlet
 ES Juego de sujeción

10 PCS

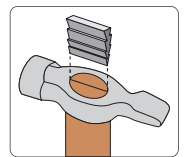

VOREL

No.	pcs / szt.	
99472	10	6/72

EN Hammer wedges
 PL Zestaw klinujących
 DE Keilesatz
 RU Набор клинов
 CS Sada klínků
 RO Set cultivator
 HU Ékelő készlet
 ES Juego de sujeción



JUCO

No.	For hammer / Do mlotka [kg]	For axe / Do siekiery [kg]	
99463	5-6	0.6-1.0	50
99464	8-10	1.2-2.5	50

EN Pick axe
 PL Kilof bez trzonka
 DE Spitzhacke ohne Stiel
 RU Кирка двухсторонняя без черенка

CS Násada na krumpáč
 RO Coadă tarnacop
 HU Csákánynyél
 ES Palo para pico

2.5 kg 



VOREL 

No.	m [kg]	
32901	2.5	8

EN Pick axe
 PL Kilof oprawiony
 DE Spitzhacke
 RU Кирка двухсторонняя с черенком

CS Krumpáč osazený
 RO Târâncop cu coadă
 HU Ékelet csákány
 ES Piqueta

2.5 kg 



VOREL 

No.	m [kg]	
32900	2.5	6

EN Wooden handle for pick axe
 PL Trzonek do kilofa
 DE Stiel für Spitzhacke
 RU Черенок для кирки

CS Násada na krumpáč
 RO Coadă tarnacop
 HU Csákánynyél
 ES Palo para pico

90 cm 



No.	L [cm]	For / Dia	
32902	90	32901	10

EN Wood splitter
 PL Klin do rozłupywania drewna
 DE Spaltkeil
 RU Клин для раскалывания бревен

CS Klín na štípání polen
 RO Pana pt. lemn
 HU Fahasító ék
 ES Cuaña para partir madera





JUCO

No.	m [kg]	
32922	2	1
32923	3	1

Memo

Memo

7

Clamps & vices Ściski i imadła



Clamps Ściski



74-76

F-clamps & sets

Ściski stolarskie i zestawy..... 74

Quick release clamps

Ściski szybkozaciskowe..... 74

Battenboard clamps

Ściski do klejenia płyt stolarskich..... 75

Spring clamps

Ściski sprężynowe..... 75

Corner clamps

Ściski kątowe..... 75

Frame clamps

Ściski taśmowe..... 75

C-clamps

Ściski typu „C”..... 76

Ratchet floor clamps

Pasy ściągające do paneli podłogowych..... 76

Vices Imadła

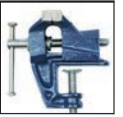

76-77

Baby vices

Imadła stołowe..... 76

Bench vices

Imadła ślusarskie..... 77

Hinged pipe vices

Imadła zaciskowe do rur..... 77

EN F-clamp
 PL Ścisk stolarski
 DE Schraubzwinge
 RU Струбцина
 CS Truhlářské upínadlo
 RO Presa lemn
 HU Asztalos szorító
 ES Tornillo de apriete



7 **VOREL**

No.	Size / Rozmiar [mm]	
37100	50x100	12/60
37101	50x150	12/60
37102	50x200	12/60
37103	50x250	12/60
37104	50x300	12/60
37106	80x200	10/30
37107	80x250	10/30
37108	80x300	10/20
37109	80x500	10/20
37110	120x300	10/20
37111	120x500	10
37112	120x800	10
37113	120x1000	6
37114	120x1200	6
37115	120x1500	6

EN F-clamp
 PL Ścisk stolarski
 DE Schraubzwinge
 RU Струбцина
 CS Truhlářské upínadlo
 RO Presa lemn
 HU Asztalos szorító
 ES Tornillo de apriete

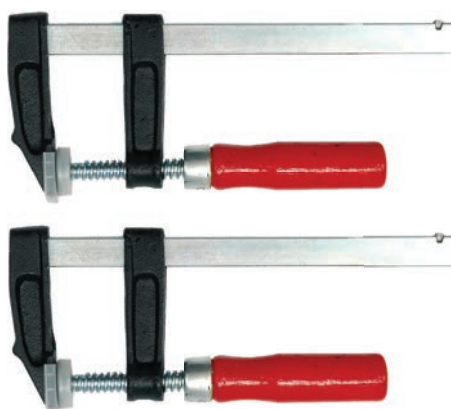

No.	Size / Rozmiar [mm]	pcs / szt.	
38150	50x150	2	10/30
38200	50x200	2	10/30

EN F-clamp
 PL Ścisk stolarski
 DE Schraubzwinge
 RU Струбцина
 CS Truhlářské upínadlo
 RO Presa lemn
 HU Asztalos szorító
 ES Tornillo de apriete

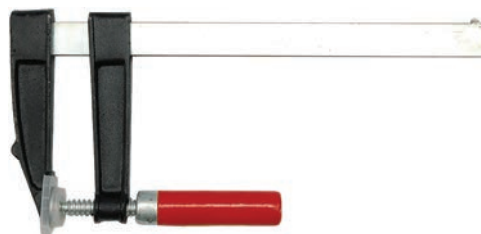

No.	Size / Rozmiar [mm]	
37150	50x150	12/60
37200	50x200	12/60
37250	50x250	12/60
37300	50x300	12/60
37380	80x300	15/30
37400	80x500	15/30
37430	120x300	10/20
37500	120x500	10/20
37800	120x800	10
37900	120x1000	10

EN Quick release clamp
 PL Ścisk szybkozaciskowy
 DE Schnellklemme
 RU Быстрозажимная струбцина
 CS Svěrká rychloupínací
 RO Clemă cu prindere rapidă
 HU Gyors asztalos szorító
 ES Apretador rápido



VOREL

No.	L [mm]	Max. expand range / Maks. zasięg rozpięcia [mm]	Max. clamping range / Maks. zasięg ściskania [mm]	Max. jaws depth / Maks. głębokość szczęk [mm]	
38401	150	141-312	0-152	63	12/36
38402	200	141-355	0-203	63	6/36
38403	250	141-405	0-254	63	6/30
38404	300	141-464	0-304	63	6/30
38406	350	141-555	0-355	63	6/24
38407	450	141-617	0-457	63	6/24
38408	600	141-769	0-609	63	6/18
38409	750	141-922	0-762	63	6/12

EN Squeezing clamp
 PL Ścisik z prowadnicą aluminiową do klejenia płyt
 DE Aluminium-Fugzwinge
 RU Струбцина-вайма
 CS Dverový upínač
 RO Menghina pt. tamplarie
 HU Táblásító szorító
 ES Prensa sargento de aluminio

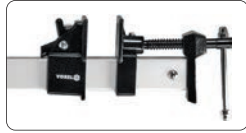

VOREL

No.	L [mm]	
38642	900	10
38641	1500	10
38643	2400	3/10

EN Spring clamp
 PL Ścisik sprężynowy
 DE Federklemme
 RU Струбцина пружинная
 CS Pružinové upínadlo
 RO Cleste presa pt. lemn
 HU Rugós szorító
 ES Pinza



No.	L [mm]	
38500	100	24/240
38515	150	12/120
38525	200	10/100

EN Corner clamp
 PL Ścisik stolarski kątowy
 DE Gehrungszwinge
 RU Струбцина угловая
 CS Truhlářské upínadlo úhlové
 RO Cleste presa colt
 HU Asztalos szorító, sarok
 ES Tornillo de angulo



VOREL

No.	Size / Rozmiar [mm]	
38751	65x70	6/12

EN Pipe clamps
 PL Ścisik do klejenia płyt mocowanie na rurę
 DE Holz kleben Rohrschelle
 RU Струбцина трубная
 CS Trubková zvierka
 RO Menghina tamplarie pt. tevi
 HU Végtelen csavaros fém szorító
 ES Prensa sargento para carpintería

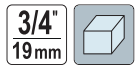

VOREL

No.	
38620	12

EN Corner clamp
 PL Ścisik stolarski kątowy
 DE Gehrungszwinge
 RU Струбцина угловая
 CS Truhlářské upínadlo úhlové
 RO Cleste presa colt
 HU Asztalos szorító, sarok
 ES Tornillo de angulo



No.	Size / Rozmiar [mm]	
38750	75	10/100

EN Frame clamp
 PL Ścisik taśmowy
 DE Bandzwinge
 RU Ленточный зажим
 CS Pásová svorka
 RO Clema pt. cadru
 HU Szalagos szorító
 ES Tensor de cinta



VOREL

No.	Tape length / Długość taśmy [m]	
38531	4	20

- EN C clamp
 PL Ścisk typu „C”
 DE C-Schraubzwinke
 RU Струбцина тип „G”
- CS Sverka tvaru „C”
 RO Menghina tip „C”
 HU Pillanatszorító
 ES Tornillo tipo „C”



No.	Jaws range / Rozstaw szczęk [mm]	Force pressure / Siła nacisku [kg]	
38430	50	140	50
38431	75	190	50
38432	100	270	30
38433	125	320	20
38434	150	360	18
38435	200	390	10
38436	250	420	6

- EN Ratchet floor clamp
 PL Pas ściągający do paneli podłogowych
 DE Spanngurt für Laminatpannele
 RU Ремень для стяжки напольных панелей
 CS Stahovací pás na podlažní panele
 RO Curea elastică strâns plăci parchet
 HU Padlópanelhez rögzítő pánt
 ES Cinta tirante para placas de suelo



No.	Tape length / Długość taśmy [m]	
82355	5	10/20

- EN Baby vice - swivel base
 PL Imadło stołowe obrotowe
 DE Bankschraubstock drehbar
 RU Тиски настольные поворотные
 CS Stolní svěrák otáčivý
 RO Menghină rotativă de masă
 HU Satu, asztali, forgó
 ES Tornillo de apriete giratorio



No.	Jaws width / Szerokość szczęk [mm]	
36014	40	12/24
36015	50	10/20
36016	60	9/18
36018	75	6/12

- EN C-clamp set
 PL Ściski modelarskie
 DE Mini-Schraubzwingensatz
 RU Набор струбцин G-типа
- CS Modelářské upínadlo
 RO Presa lemni tip „C” set
 HU Modellező szorítók
 ES Tornillos tipo „C”



No.	Jaws range / Rozstaw szczęk [mm]	
38830	25, 50, 75	12/48

- EN Baby vice - fixed base
 PL Imadło stołowe
 DE Bankschraubstock
 RU Тиски настольные неповоротные
 CS Stolní svěrák
 RO Menghină de masă
 HU Satu, asztali
 ES Tornillo de apriete



No.	Jaws width / Szerokość szczęk [mm]	
36000	25	15/60
36004	40	12/48
36005	50	18/36
36006	60	12/24
36008	70	10/20

- EN Baby vice - fixed base
 PL Imadło stołowe
 DE Bankschraubstock
 RU Тиски настольные поворотные
 CS Stolní svěrák
 RO Menghină de masă
 HU Satu, asztali
 ES Tornillo de apriete

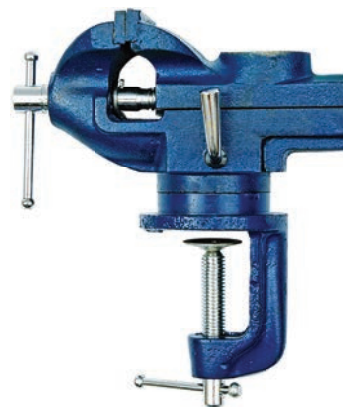

No.	Jaws width / Szerokość szczęk [mm]	
36650	65	10

EN Bench vice - fixed base
 PL Imadło ślusarskie
 DE Schlosserschraubstock
 RU Тиски слесарные с наковальней

CS Zámečnický svěrák
 RO Menghină de lăcătuşerie
 HU Satu, lakatos
 ES Tornillo de apriete

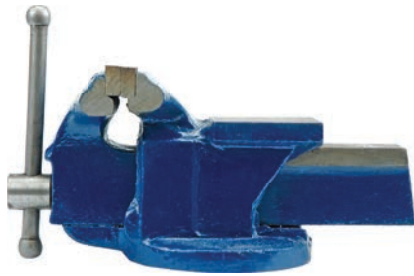

No.	Jaws width / Szerokość szczęk [mm]	
36032	100	1
36033	125	1
36034	150	1/1

EN Hinged pipe vice
 PL Imadło zaciskowe do rur
 DE Rohrschraubstock
 RU Тиски для труб
 CS Uprínací svěrák na trubky
 RO Menghină pt. țevi
 HU Satu, csőszorító
 ES Tornillo de apriete para tubos



No.	Mounting element diameter / Średnica mocowanego elementu [mm]	
36570	13-50	6

EN Bench vice - swivel base
 PL Imadło ślusarskie obrotowe
 DE Schlosserschraubstock drehbar
 RU Тиски слесарные поворотные

CS Zámečnický svěrák otáčivé
 RO Menghină de lăcătuşerie rotativă
 HU Satu, lakatos forgó
 ES Tornillo de apriete giratorio



No.	Jaws width / Szerokość szczęk [mm]	
36037	100	1
36038	125	1
36039	150	1

7

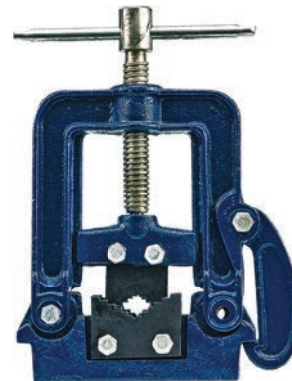

Memo

8

Cutting tools Narzędzia tnące



Drill bits Wiertła

81-90



Twist drill bits HSS & sets
Wiertła do metalu HSS i zestawy..... 81

Twist drill bits HSS-G & sets
Wiertła do metalu HSS-G i zestawy..... 82

Step drills & sets
Wiertła stopniowe i zestawy..... 82

Universal drills & sets
Wiertła uniwersalne i zestawy..... 83

Masonry drill bits & sets
Wiertła do betonu i zestawy..... 84

Wood drill bits
Wiertła do drewna..... 84

SDS Masonry drill bits & sets
Wiertła do betonu SDS i zestawy..... 85

SDS Chisels
Przecinaki i dłuta SDS..... 86

Hollow drill sets
Wiertła koronowe do betonu..... 88

Hole saw kits
Zestawy otwornic..... 88

Tungsten carbide hole saws
Otwornice z węglikiem wolframu..... 89

Drills for glass, ceramic tiles & sets
Wiertła do szkła, ceramiki, gresu i zestawy..... 89

Jigs & patterns
Wzorniki i szablony..... 90

Tools for dowel joints Narzędzia do połączeń kołkowych

90



Taps & dies Narzędzia do gwintowania

90-92



Hand taps CZ TOOLS
Gwintowniki CZ TOOLS..... 90

Machine taps CZ TOOLS
Gwintowniki maszynowe CZ TOOLS..... 91

Circular dies CZ TOOLS
Narzynki CZ TOOLS..... 91

Tap & die sets CZ TOOLS
Zestawy gwintowników i narzynek CZ TOOLS..... 91

Tap wrenches & die holders
Pokręta do gwintowników i narzynek..... 91

Tap & die sets
Zestawy gwintowników i narzynek..... 92

Screw extractor sets
Wykrętaki do zerwanych śrub..... 92

Router bits, rotary rasps & sets Frezy do drewna, metalu i zestawy

92



Diamond tools Narzędzia diamentowe

93-94



Diamond blades for cutting construction materials
Tarcze diamentowe do cięcia materiałów budowlanych..... 93

Diamond rod saws
Brzeszczoty diamentowe..... 94

Tungsten carbide tipped tools Narzędzia z ostrzem z węglika wolframu

94



Tungsten carbide saws for wood
Tarcze z węglikiem do drewna..... 94

Tungsten carbide saws for aluminium
Tarcze z węglikiem do aluminium..... 94

Cutting & grinding discs Tarcze do cięcia i szlifowania

94-95



Metal cutting discs
Tarcze do cięcia metalu..... 94

Metal grinding discs
Tarcze do szlifowania metalu..... 95

Stone cutting discs
Tarcze do cięcia kamienia..... 95

Stone grinding discs
Tarcze do szlifowania kamienia..... 95

Flap discs Ściernice listkowe talerzowe

95



Grinding discs Tarcze do szlifierek stołowych

96



Shears Nożyce

96-98



Tin snips
Nożyce do blachy..... 96

Bolt cutters
Nożyce do prętów..... 97

Saws & blades Piły i brzeszczoty

98-104



Hand saws
Piły do drewna..... 98

Bow saws
Piły kabląkowe..... 99

Bow saw blades
Brzeszczoty do pił kabląkowych..... 99

Compass saws
Piły otwornice..... 99

Saws for gas concrete
Piły do gazobetonu..... 99

Hacksaw frames
Piły do metalu..... 99

Cross cut saws
Piły poprzeczne..... 101

Miter saws Piły kątowe.....	101
Miter boxes Skrzynki uciosowe.....	101
Blades Brzeszczoty.....	102
Jig saw blades Brzeszczoty do wyrzynarek.....	104
Brushes, knives & files Szczotki, noże i pilniki	104-117
Wire brushes Szczotki druciane.....	104
Cup brushes Szczotki tarczowe.....	105
Rubber discs Tarcze gumowe do elektronarzędzi.....	106
Pocket knives Noże składane.....	108
Window scrapers Skrobaki do szyb.....	111
Glass cutters Nożyki do cięcia szkła.....	111
Marking out tools Narzędzia traserskie.....	111
Scrapers Cykliny.....	112
Wood carving knife sets Zestawy nożyków precyzyjnych.....	112
Scissors Nożyczki.....	112
Leatherwork accessories Akcesoria kaletnicze.....	112
Wood planes Strugi.....	113
Steel files Pilniki do metalu.....	114
Diamond whetstones & sets Oselki diamentowe i zestawy.....	115
Rasps Tarniki do drewna.....	115
Rasps for plaster Tarniki do gipsu.....	116



Abrasive products Artykuły ściernie

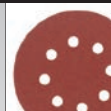

.....	117-120
Sharpening stones Oselki.....	117
Waterproof sand papers Papiery ściernie wodoodporne.....	117
Abrasive clothes Piłna ściernie.....	118
Abrasive meshes Siatki ściernie.....	118
No end abrasive bands Taśmy ściernie bezkońcowe.....	118
Abrasive sponges Kostki ściernie.....	118
Abrasive sheets and discs Arkusze i krążki ściernie.....	119
Sanding blocks Błoki ściernie.....	119
Polishing sets Zestawy polerskie.....	120

EN Twist drill bit
 PL Wiertło do metalu
 DE Spiralbohrer
 RU Сверло по металлу
 CS Vrták na kov
 RO Burghiu pt. metal
 HU Fúrószer fémhez
 ES Broca para metalo



STHOR

No.	Ø [mm]	pcs / szt.	
20100	1.0	10	200/10000
20150	1.5	10	200/8000
20200	2.0	10	200/8000
20250	2.5	10	200/4000
20280	2.8	10	200/4000
20300	3.0	10	200/4000
20320	3.2	10	100/4000
20350	3.5	10	100/4000
20400	4.0	10	100/4000
20420	4.2	10	100/2500
20450	4.5	10	100/2500
20500	5.0	10	100/2500
20550	5.5	10	100/2000
20600	6.0	10	50/1200
20650	6.5	10	50/1200
20700	7.0	10	50/1200
20800	8.0	5	50/600
20850	8.5	5	50/600
20900	9.0	5	50/600
21000	10.0	5	50/250
21100	11.0	5	50/250
21200	12.0	5	50/250
21250	12.5	5	50/250
21300	13.0	5	50/250
21400	14.0	5	50/200
21600	16.0	5	10/100

EN Twist drill set
 PL Komplet wiertel do metalu
 DE Spiralbohrersatz
 RU Набор сверл по металлу
 CS Vrtáky na kov
 RO Burghie pt. metal
 HU Fúrószer fémhez
 ES Broca para metalo



STHOR

No.	Ø [mm]	pcs / szt.	
22330	1, 1.5, 2, 2.5, 3, 3.5, 4, 4.5, 5, 5.5, 6, 6.5, 7, 7.5, 8, 8.5, 9, 9.5, 10	19	30
22340	1, 1.5, 2.0, 2.5, 3.0, 3.5, 4.0, 4.5, 5, 5.5, 6, 6.5, 7, 7.5, 8, 8.5, 9, 9.5, 10, 10.5, 11, 11.5, 12, 12.5, 13	25	20

EN Twist drill set
 PL Komplet wiertel do metalu
 DE Spiralbohrersatz
 RU Набор сверл по металлу
 CS Vrtáky na kov
 RO Burghie pt. metal
 HU Fúrószer fémhez
 ES Broca para metalo



STHOR

No.	Ø [mm]	pcs / szt.	
22130	1.5, 2, 2.5, 3, 3.2, 3.5, 4, 4.5, 4.8, 5, 5.5, 6, 6.5	13	25/100
22180	2, 2.5, 3, 3.5, 4, 4.5, 5, 5.5, 6, 6.5, 7, 7.5, 8	13	25/50

EN Twist drill set
 PL Komplet wiertel do metalu
 DE Spiralbohrersatz
 RU Набор сверл по металлу
 CS Vrtáky na kov
 RO Burghie pt. metal
 HU Fúrószer fémhez
 ES Broca para metalo



STHOR

No.	Ø [mm]	pcs / szt.	
22190	1, 1.5, 2, 2.5, 3, 3.5, 4, 4.5, 5, 5.5, 6, 6.5, 7, 7.5, 8, 8.5, 9, 9.5, 10	19	30
22250	1, 1.5, 2, 2.5, 3, 3.5, 4, 4.5, 5, 5.5, 6, 6.5, 7, 7.5, 8, 8.5, 9, 9.5, 10, 10.5, 11, 11.5, 12, 12.5, 13	25	20

EN Twist drill set
 PL Komplet wiertel do metalu
 DE Spiralbohrersatz
 RU Набор сверл по металлу
 CS Vrtáky na kov
 RO Burghie pt. metal
 HU Fúrószer fémhez
 ES Broca para metalo



STHOR

No.	Ø [mm]	pcs / szt.	
22300	1.5, 2.0, 2.5, 3.0, 3.2, 3.5, 4.0, 4.5, 4.8, 5.0, 5.5, 6.0, 6.5	13	25/100
22310	2.0, 2.5, 3.0, 3.5, 4.0, 4.5, 5.0, 5.5, 6.0, 6.5, 7.0, 7.5, 8.0	13	25/50

EN HSS twist drill bit
 PL Wiertło do metalu HSS
 DE Spirallbohrer HSS
 RU Сверло по металлу HSS
 CS Vrták na kov HSS
 RO Burghiu pt. metal HSS
 HU Fúrószár fémhez HSS
 ES Broca para metalo HSS

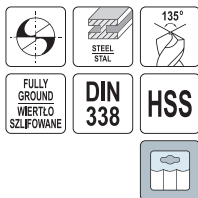

STHOR

No.	Ø [mm]	pcs / szt.	Box
21900	1.0	10	20/1000
21905	1.5	10	20/1000
21910	2.0	10	20/800
21915	2.5	10	20/800
21919	3.0	10	20/500
21921	3.2	10	20/400
21924	3.5	10	20/400
21927	4.0	10	10/400
21929	4.2	10	10/250
21932	4.5	10	10/250
21934	4.8	10	10/250
21936	5.0	10	10/250
21941	5.5	10	10/200
21944	6.0	10	10/120
21948	6.5	10	5/120
21950	7.0	5	10/120
21951	7.5	5	10/120
21952	8.0	5	10/120
21955	8.5	5	10/120
21956	9.0	5	10/120
21958	10.0	5	10/50
21961	11.0	5	10/50
21963	12.0	5	10/50
21966	13.0	3	16/48

EN Step drill
 PL Wiertło stopniowe
 DE Stufenbohrer
 RU Сверло ступенчатое
 CS Stupňovitý vrták
 RO Burghiu din titan cu gaurire in trepte
 HU Lépcsős fúró
 ES Broca cónica escalonada

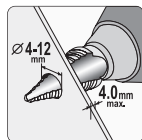

STHOR

No.	Ø [mm]	Box
22610	4, 6, 8, 10, 12	25/200

EN Twist drill set
 PL Zestaw wiertel do metalu
 DE Metallspiralbohrersatz
 RU Набор сверл по металлу
 CS Souprava vrtáků na kov
 RO Set de burghie pt. metal
 HU Fúrószárkészlet fémhez
 ES Juego de brocas para metal

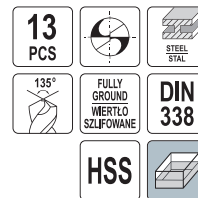

STHOR

No.	Ø [mm]	pcs / szt.	Box
21998	2, 2.5, 3, 3.5, 4, 4.5, 5, 5.5, 6, 6.5, 7, 7.5, 8	13	10/50

EN Twist drill set
 PL Zestaw wiertel do metalu
 DE Metallspiralbohrersatz
 RU Набор сверл по металлу
 CS Souprava vrtáků na kov
 RO Set de burghie pt. metal
 HU Fúrószárkészlet fémhez
 ES Juego de brocas para metal

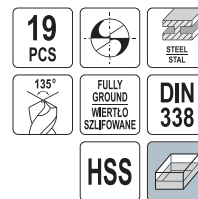

STHOR

No.	Ø [mm]	pcs / szt.	Box
21999	1, 1.5, 2, 2.5, 3, 3.5, 4, 4.5, 5, 5.5, 6, 6.5, 7, 7.5, 8, 8.5, 9, 9.5, 10	19	5/30

EN Twist drill set
 PL Komplet wiertel do metalu
 DE Metallspiralbohrersatz
 RU Набор сверл по металлу
 CS Souprava vrtáků na kov
 RO Set de burghie pt. metal
 HU Fúrószárkészlet fémhez
 ES Juego de brocas para metal

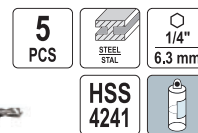

STHOR

No.	Ø [mm]	pcs / szt.	Box
21650	4, 5, 6, 8, 10	5	30/60

EN Step drill
 PL Wiertło stopniowe
 DE Stufenbohrer
 RU Сверло ступенчатое
 CS Stupňovitý vrták
 RO Burghiu din titan cu gaurire in trepte
 HU Lépcsős fúró
 ES Broca cónica escalonada

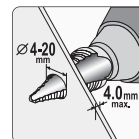

STHOR

No.	Ø [mm]	Box
22611	4, 6, 8, 10, 12, 14, 16, 18, 20	25/100

EN Step drill
 PL Wiertło stopniowe
 DE Stufenbohrer
 RU Свёрло ступенчатое
 CS Stupňovitý vrták
 RO Burghiu din titan cu gaurire în trepte
 HU Lépcsős fúró
 ES Broca cónica escalonada

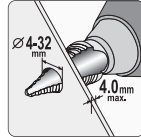
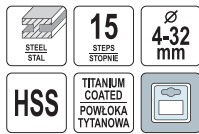

STHOR

No.	Ø [mm]	
22612	4, 6, 8, 10, 12, 14, 16, 18, 20, 22, 24, 26, 28, 30, 32	10/80

EN Step drills
 PL Zestaw wiertel stopniowych
 DE Stufenbohrer Set
 RU Набор универсальных шулки

CS Stupňovité vrtáky sada
 RO Set burghie în trepte
 HU Lépcsős fúró készlet
 ES Juego de brocas cónicas escalonadas

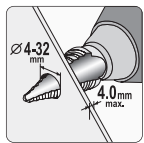

STHOR

No.	Ø [mm]	
22616	4-12 (4, 6, 8, 10, 12 mm), 4-20 (4, 6, 8, 10, 12, 14, 16, 18, 20, 22, 24, 26, 28, 30, 32 mm), 4-32 (4, 6, 8, 10, 12, 14, 16, 18, 20, 22, 24, 26, 28, 30, 32 mm)	20

EN Universal drills
 PL Komplet wiertel uniwersalnych
 DE Universalbohrer-Set
 RU Набор универсальных сверл
 CS Sada víceúčelový vrtáky
 RO Set burghie universal
 HU Keményfém többcélyú fúró készlet
 ES Sets de brocas multimaterial



STHOR

No.	Ø [mm]	pcs / szt.	
21695	4, 5, 6, 8, 10	5	25/100

EN Universal drill
 PL Wiertło uniwersalne
 DE Universalbohrer
 RU Универсальное сверло с шестигранным хвостовиком

CS Víceúčelový vrták
 RO Burghiu universal cu coada hexagonala
 HU Kőzet és többcélyú fúró
 ES Broca multimaterial

STHOR

No.	Ø [mm]	L [mm]	
21680	3	75	150/600
21682	4	80	150/600
21684	5	85	100/400
21686	6	110	100/400
21688	7	110	100/400
21690	8	120	100/400
21691	10	120	50/200
21692	12	150	50/200

EN Step drill
 PL Wiertło stopniowe
 DE Stufenbohrer
 RU Свёрло ступенчатое
 CS Stupňovitý vrták
 RO Burghiu din titan cu gaurire în trepte
 HU Lépcsős fúró
 ES Broca cónica escalonada

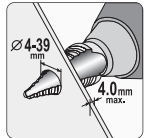

STHOR

No.	Ø [mm]	
22613	4, 6, 9, 12, 15, 18, 21, 24, 27, 30, 33, 36, 39	10/40

EN Step drills
 PL Zestaw wiertel stopniowych
 DE Stufenbohrer Set
 RU Набор универсальных шулки

CS Stupňovité vrtáky sada
 RO Set burghie în trepte
 HU Lépcsős fúró készlet
 ES Juego de brocas cónicas escalonadas

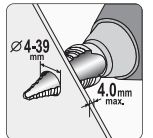
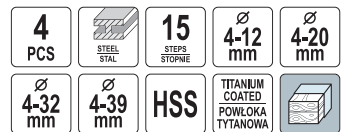

STHOR

No.	Ø [mm]	
22617	4-12 (4, 6, 8, 10, 12 mm), 4-20 (4, 6, 8, 10, 12, 14, 16, 18, 20 mm), 4-32 (4, 6, 8, 10, 12, 14, 16, 18, 20, 22, 24, 26, 28, 30, 32 mm), 4-39 (4, 6, 9, 12, 15, 18, 21, 24, 27, 30, 33, 36, 39 mm)	20

EN Universal drills
 PL Komplet wiertel uniwersalnych
 DE Universalbohrer-Set
 RU Набор универсальных сверл
 CS Sada víceúčelový vrtáky
 RO Set burghie cu coada hexagonala
 HU Keményfém többcélyú fúró készlet
 ES Sets de brocas multimaterial



STHOR

No.	pcs / szt.	
22640	4	25/100



- EN Masonry drill set
- PL Wiertła do betonu
- DE Betonspiralbohrersatz
- RU Сверла по бетону в наборе
- CS Souprava vrtáků do betonu
- RO Set de burghie pt. beton
- HU Fúrószerkészlet betonhoz
- ES Brocas para hormigón



5
PCS

No.	Ø [mm]	pcs / szt.	
23331	4, 5, 6, 8, 10	5	50/100

- EN Wood drill set
- PL Wiertła do drewna
- DE Holzbohrersatz
- RU Набор сверел по дереву
- CS Vrtáky do dřeva
- RO Burghie pt. lemn
- HU Fafúroszár készlet
- ES Brocas para madera

5
PCS



No.	Ø [mm]	pcs / szt.	
22350	4, 5, 6, 8, 10	5	25/200

- EN Wood drill set
- PL Wiertła do drewna
- DE Holzbohrersatz
- RU Набор сверел по дереву
- CS Vrtáky do dřeva
- RO Burghie pt. lemn
- HU Fafúroszár készlet
- ES Brocas para madera

8
PCS



No.	Ø [mm]	pcs / szt.	
22381	3, 4, 5, 6, 7, 8, 9, 10	8	10/80

- EN Masonry drill bit
- PL Wierćko do betonu
- DE Betonbohrer
- RU Сверло по бетону
- CS Vrták na beton
- RO Burghiu pt. beton
- HU Fúrószer betonhoz
- ES Broca para hormigón

CONCRETE
BETON



STHOR

No.	Ø [mm]	L [mm]	
23311	4	75	200/1600
23312	5	85	200/800
23313	6	100	200/1000
23314	7	100	200/1000
23315	8	120	100/500
23325	8	400	50/200
23316	10	120	100/500
23326	10	400	50/100
23317	12	150	50/250
23327	12	400	50/100
23318	14	150	50/150
23329	16	400	25/50

- EN Wood drill set
- PL Wiertła do drewna
- DE Holzbohrersatz
- RU Набор сверел по дереву
- CS Vrtáky do dřeva
- RO Burghie pt. lemn
- HU Fafúroszár készlet
- ES Brocas para madera

8
PCS



STHOR

No.	Ø [mm]	pcs / szt.	
22380	3, 4, 5, 6, 7, 8, 9, 10	8	20/100

- EN Wood drill set
- PL Wiertła do drewna
- DE Holzbohrersatz
- RU Набор сверел по дереву
- CS Vrtáky do dřeva
- RO Burghie pt. lemn
- HU Fafúroszár készlet
- ES Brocas para madera

6
PCS



STHOR

No.	Ø [mm]	L [mm]	pcs / szt.	
22460	6, 8, 10, 12, 13, 14	300	6	25

EN Wood drill set
 PL Wiertła do drewna
 DE Holzbohrersatz
 RU Набор сверел по дереву
 CS Vrtáky do dřeva
 RO Burghie pt. lemn
 HU Fafúrószár készlet
 ES Brocas para madera



6
PCS

WOOD
DREWNIO

230
mm

STHOR

No.	Ø [mm]	L [mm]	pcs / szt.	
22465	10, 12, 14, 16, 18, 20	230	6	10

EN Flat wood bits
 PL Wiertła do drewna, łopatkowe
 DE Holz-Flachfräsbohrersatz
 RU Набор сверел по дереву
 CS Vrtáky do dřeva
 RO Burghie pt. lemn
 HU Fafúrószár készlet
 ES Brocas para madera



6
PCS

WOOD
DREWNIO

No.	Ø [mm]	pcs / szt.	
22500	10, 12, 16, 18, 20, 25	6	10/100

EN Hand gimlet set
 PL Zestaw świderków ręcznych
 DE Handbohrer
 RU Буров по дереву
 CS Nebozez kovový
 RO Burghiu de palma
 HU Kézi fúró
 ES Broca manual



3
PCS

VOREL

No.	Ø [mm]	pcs / szt.	
22430	1.5, 2, 3	3	15/360

EN Hand gimlet set
 PL Zestaw świderków ręcznych
 DE Handbohrer
 RU Буров по дереву
 CS Nebozez kovový
 RO Burghiu de palma
 HU Kézi fúró
 ES Broca manual



4
PCS

VOREL

No.	Ø [mm]	pcs / szt.	
22431	2, 3, 4, 5	4	20/200

EN Wood drill set
 PL Wiertła do drewna
 DE Holzbohrersatz
 RU Набор сверел по дереву
 CS Vrtáky do dřeva
 RO Burghie pt. lemn
 HU Fafúrószár készlet
 ES Brocas para madera



6
PCS

WOOD
DREWNIO

460
mm

STHOR

No.	Ø [mm]	L [mm]	pcs / szt.	
22466	10, 12, 14, 16, 18, 20	460	6	10

EN Masonry drill bit
 PL Wiertło do betonu
 DE Betonbohrer
 RU Бур по бетону
 CS Vrták na beton
 RO Burghiu pt. beton
 HU Fúrószár betonhoz
 ES Broca para hormigon

CONCRETE
BETON

SDS
PLUS



STHOR

No.	Ø [mm]	L [mm]	
23620	5	110	10/500
23640	6	110	10/500
23650	6	160	10/500
23660	6	210	10/300
23670	8	110	10/500
23680	8	160	10/400
23690	8	210	10/250
23692	8	300	10/200
23693	8	460	10/100
23694	8	600	10/100
23710	10	160	10/300
23720	10	210	10/250
23722	10	300	10/150
23723	10	460	10/100
23724	10	600	10/100
23730	12	160	10/300
23740	12	460	10/100
23750	12	266	10/150
23752	12	600	10/60
23800	14	166	10/200
23820	14	460	10/80
23830	14	266	10/150
23832	14	600	10/50
23840	16	200	10/160
23850	16	300	8/96
23860	16	460	8/48
23862	16	600	8/48
23880	18	300	8/72
23882	18	460	6/48
23883	18	600	6/48
23920	20	300	5/50
23930	20	460	5/50
23932	20	600	5/30
23960	22	460	5/25
23962	22	600	5/25
23980	25	300	5/50
23982	25	600	5/15
23990	25	460	5/25
23992	28	600	2/10
23999	30	600	5/10

EN Masonry drill bit
PL Wiertło do betonu
DE Betonbohrer
RU Бур по бетону

CS Vrták na beton
RO Burghiu pt. beton
HU Fúrószár betonhoz
ES Broca para hormigon



STHÖR

No.	Ø [mm]	L [mm]	
23371	16	300	10/50
23390	16	600	5/30
23411	16	900	4/20
23372	18	300	10/50
23391	18	600	5/30
23412	18	900	4/20
23373	20	300	8/40
23392	20	600	4/20
23413	20	900	2/10
23374	22	300	6/30
23393	22	600	4/20
23414	22	900	2/10
23375	24	300	6/30
23394	24	600	4/20
23415	24	900	2/10
23376	25	300	6/30
23395	25	600	4/20
23416	25	900	2/10
23377	26	300	6/30
23396	26	600	2/10
23417	26	900	2/10
23397	28	600	2/10
23418	28	900	5
23379	30	300	4/20
23398	30	600	2/10
23419	30	900	5
23380	32	300	4/20
23399	32	600	2/10
23420	32	900	5
23381	35	300	4/20
23400	35	600	2/10
23421	35	900	5
23382	37	300	4/20
23422	37	900	5
23402	38	600	1/5
23423	38	900	5
23403	40	600	5
23424	40	900	5

EN Flat chisel
PL Dłuto wąskie
DE Flachmeißel
RU Зубило узкое

CS Sekáč
RO Daltă spatulată
HU Lapos véső
ES Cincel plano



STHÖR

No.	Ø [mm]	Working width / Szerokość robocza [mm]	L [mm]	
23591	14	20	250	25/50

EN Masonry drill set
PL Komplet wiertel do betonu
DE Betonbohrersatz
RU Набор буров по бетону
CS Souprava vrtáků do betonu
RO Set de burghie pt. beton
HU Fúrószárkészlet betonhoz
ES Juego de brocas



STHÖR

No.	Ø [mm]	pcs / szt.	
23988	5, 6, 8, 10, 12	5	15/60

EN Point chisel
PL Szpicak
DE Spitzmeißel
RU Зубило пиковое

CS Špičák
RO Dorn
HU Hegyes véső
ES Cincel punta



STHÖR

No.	Ø [mm]	Working width / Szerokość robocza [mm]	L [mm]	
23590	14	1.5	250	25/50

EN Point chisel
PL Grot SDS Max
DE Spitzmeißel
RU Зубило пиковое

CS Špičák
RO Dorn
HU Hegyes véső
ES Cincel punta



STHÖR

No.	Ø [mm]	Working width / Szerokość robocza [mm]	L [mm]	
23601	18	1.5	280	20/40
23602	18	1.5	400	15/30

EN Flat chisel
PL Dłuto wąskie SDS Max
DE Flachmeißel
RU Зубило узкое

CS Sekáč
RO Daltă spatulată
HU Lapos véső
ES Cincel plano



STHÖR

No.	Ø [mm]	Working width / Szerokość robocza [mm]	L [mm]	
23603	18	25	280	20/40
23604	18	25	400	10/20

EN Spade chisel
 PL Dłuto szerokie
 DE Spatmeißel
 RU Зубило плоское широкое

CS Sekáč plochý
 RO Dalta
 HU Széles véső
 ES Cincel pala



STHOR

No.	Ø [mm]	Working width / Szerokość robocza [mm]	L [mm]	
23592	14	40	250	25/50

EN Spade chisel
 PL Dłuto szerokie SDS Max
 DE Spatmeißel
 RU Зубило плоское широкое

CS Sekáč plochý
 RO Dalta
 HU Széles véső
 ES Cincel pala



STHOR

No.	Ø [mm]	Working width / Szerokość robocza [mm]	L [mm]	
23605	18	40	280	20/40
23606	18	50	400	10/20

EN Groove chisel
 PL Bruzdownik
 DE Nutenmeißel
 RU Зубило-штробер

CS Sekáč drážkovací
 RO Dalta canal
 HU Horonyvéső
 ES Cincel acanalado



STHOR

No.	Ø [mm]	Working width / Szerokość robocza [mm]	L [mm]	
23608	18	25	400	20/20

EN Hammer drill & chisel set
 PL Komplet wiertel i przecinaków do betonu
 DE Bohrer und Meißel Satz
 RU Набор буров и зубил

CS Souprava vrtáků + sekáče
 RO Set de burghie + dalte tăietor
 HU Fúrószárkészlet + hidegvágó
 ES Juego de cinceles y brocas

VOREL

No.	pcs / szt.	
23586	14	6

EN Flat chisel
 PL Dłuto płaskie
 DE Spatmeißel
 RU Долото плоское
 CS Sekáč plochý
 RO Punctator tip dalta
 HU Széles lapos véső
 ES Cincel plano



STHOR

No.	Ø [mm]	Working width / Szerokość robocza [mm]	L [mm]	
23594	14	60	250	25/50

EN Groove chisel
 PL Bruzdownik
 DE Nutenmeißel
 RU Зубило-штробер
 CS Sekáč drážkovací
 RO Dalta canal
 HU Horonyvéső
 ES Cincel acanalado



STHOR

No.	Ø [mm]	Working width / Szerokość robocza [mm]	L [mm]	
23593	14	22	250	25/50

EN Hammer drill & chisel set
 PL Komplet wiertel i przecinaków do betonu
 DE Bohrer und Meißel Satz
 RU Набор буров и зубил

CS Souprava vrtáků + sekáče
 RO Set de burghie + dalte tăietor
 HU Fúrószárkészlet + hidegvágó
 ES Juego de cinceles y brocas

12
PCS



SDS
PLUS



VOREL

No.	pcs / szt.	
23585	12	8



14
PCS



SDS
PLUS



- EN Adapter
- PL Adapter
- DE Adapter
- RU Адаптер
- CS Adaptor
- RO Adaptor
- HU Adaptor
- ES Adaptador



STORZ

No.	L [mm]	
23460	60	100/200

- EN Hollow drill set
- PL Wiertło koronowe do muru
- DE Bohrkronen
- RU Коронка по бетону
- CS Korunový vrták na zeď - pouzdro šestiúhelník
- RO Burghiu cu coroană pt. beton - mandrină hexagonală
- HU Koronafúró falhoz – hatszögletű szárral
- ES Broca widia para muro



VOREL

No.	Ø [mm]	
03245	65	24
03246	80	20

- EN Hole saw set
- PL Wycinarka otworów do drewna
- DE Lochsägensatz
- RU Пилы кольцевые по дереву в наборе
- CS Vytínač otvorů
- RO Tăietor (ferăstrău rotund) pt. orificii
- HU Lyukasztó
- ES Sierra de corona para madera

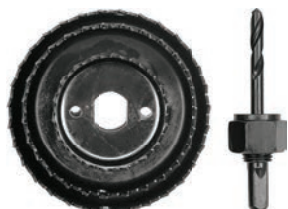

VOREL

No.	Ø [mm]	pcs / szt.	
22565	51, 76, 89	4	12/48

- EN Hole saw set
- PL Zestaw wycinarek do otworów w drewnie
- DE Lochsägensatz
- RU Пилы кольцевые по дереву в наборе
- CS Vytínač otvorů
- RO Tăietor (ferăstrău rotund) pt. orificii
- HU Lyukasztó
- ES Juego de sierras de corona



VOREL

No.	Ø [mm]	pcs / szt.	
22570	19, 21, 28, 31, 37, 43, 51, 64	11	12/36

- EN Hollow drill set
- PL Wiertło koronowe do muru
- DE Bohrkronen
- RU Коронка по бетону
- CS Korunový vrták na zeď - pouzdro šestiúhelník
- RO Burghiu cu coroană pt. beton - mandrină hexagonală
- HU Koronafúró falhoz – hatszögletű szárral
- ES Broca widia para muro



VOREL

No.	Ø [mm]	
03240	65	24
03241	80	20

- EN Drywall circle cutter
- PL Wycinarka do płyt gipsowych
- DE Schnitzzirkel für Gipsplatten
- RU Резак круговой по гипсокартону
- CS Vystřihovačka pro sádrové desky
- RO Tăietore pt. plăci de ghips
- HU Gipszfalkivágó
- ES Compas cortador para planchas de escayola



VOREL

No.	Ø [mm]	
03990	30-400	12/48

- EN Hole saw set
- PL Wycinarka otworów do drewna
- DE Lochsägensatz
- RU Пилы кольцевые по дереву в наборе
- CS Vytínač otvorů
- RO Tăietor (ferăstrău rotund) pt. orificii
- HU Lyukasztó
- ES Sierra de corona para madera

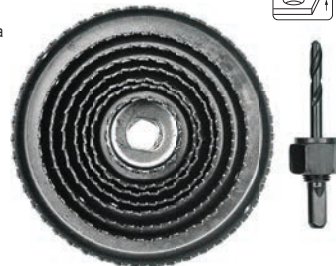
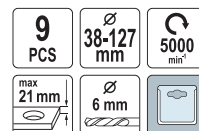

VOREL

No.	Ø [mm]	pcs / szt.	
22572	38, 51, 57, 67, 76, 89, 102, 127	9	6/24

- EN Hole saw set
- PL Zestaw wycinarek do otworów w drewnie
- DE Lochsägensatz
- RU Пилы кольцевые по дереву в наборе
- CS Vytínač otvorů
- RO Tăietor (ferăstrău rotund) pt. orificii
- HU Lyukasztó
- ES Juego de sierras de corona

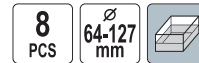

VOREL

No.	Ø [mm]	pcs / szt.	
22571	64, 76, 87, 102, 127	8	6/24

EN Hole saw for wood with hardened teeth
 PL Wyrzynarka do drewna, hartowane zęby
 DE Lochsägensatz
 RU Пилы кольцевые по дереву закалённые зубья
 CS Vyřezávací pila kalená
 RO Set freze circulare cu dinti caliti
 HU Szúrófűrész edzett
 ES Sierra de corona curtido

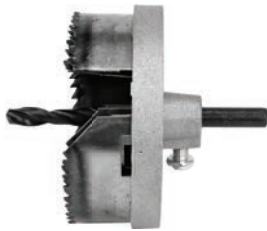
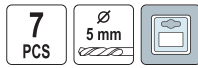

No.	Ø [mm]	Max. drilling depth / Maks. głębokość wiercenia [mm]	Icon
28680	26, 32, 38, 45, 50, 56, 63	17	10/100
28690	26, 32, 38, 45, 50, 56, 63	43	10/80

EN Hole saw set
 PL Zestaw wycinarek do otworów
 DE Lochsägensatz
 RU Пилы кольцевые по дереву
 CS Vytínač otvorů
 RO Set freze
 HU Lyukasztó
 ES Cortador de agujeros



No.	Ø [mm]	pcs / szt.	Icon
28725	60, 67, 74, 81, 95	8	6/24

EN Tungsten carbide coated hole saw set
 PL Zestaw wycinarek wolframowych
 DE Lochbohrersatz
 RU Коронки вольфрамовые

CS Sada děrovacích vrtáků pro keramiku
 RO Set freze + maner
 HU Körkivógó készlet wolfram borítással
 ES Juego de punzones de wolframio



No.	Ø [mm]	Icon
03300	33, 53, 67, 73	20
03301	33, 53, 67, 83	20

EN Drill for glass
 PL Wiertło do szkła i ceramiki
 DE Bohrer für Glas
 RU Сверло по стеклу

CS Vrták do skla
 RO Burghiu pt. sticlă
 HU Üvegfúró
 ES Broca para vidrio



No.	Ø [mm]	L [mm]	Icon
21700	3	60	125/500
21701	4	60	125/500
21702	5	70	125/500
21703	6	75	125/500
21704	8	80	125/500
21705	10	100	125/500
21706	12	100	100/400

EN Hole saw for wood
 PL Wyrzynarka do drewna
 DE Lochsägensatz
 RU Пилы кольцевые по дереву
 CS Vyřezávací pila
 RO Set freze decupat lemn
 HU Szúrófűrész
 ES Sierra de corona

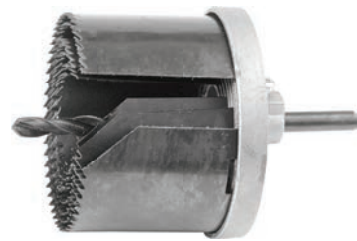
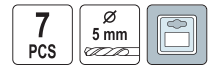

No.	Ø [mm]	Max. drilling depth / Maks. głębokość wiercenia [mm]	Icon
28710	26, 32, 38, 45, 50, 56, 63	20	10/100
28720	26, 32, 38, 45, 50, 56, 63	43	10/80

EN PVC hole cutter
 PL Otwornica do PCV
 DE PVC Lochmesser
 RU Сверло по дереву, гипсокартону, ПВХ
 CS Otvornice na PVC
 RO Dispozitiv decupat PVC
 HU Lyukasztó PVC
 ES Cortador de agujeros de PVC

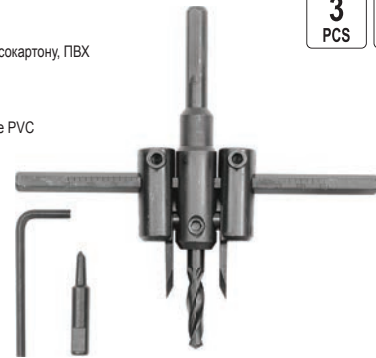

No.	Ø [mm]	pcs / szt.	Icon
28733	30-120	3	6/80

EN Tile and glass drill
 PL Wiertło do szkła i glazury
 DE Glass- und Fließbohrer
 RU Сверло по плитке и стеклу

CS Vrták do skla a glazury
 RO Burghiu pt. sticlă și glazură
 HU Üveg- és csempefúró
 ES Broca para cristal y azulejos



No.	Ø [mm]	L [mm]	Icon
05540	4	80	50/100
05560	6	90	50/100
05580	8	95	50/100
05600	10	100	50/100



EN Glass and tile drills
 PL Zestaw wiertel do szkła i ceramiki
 DE Glas- und Fliesenbohrer
 RU Набор сверл по стеклу и керамике
 CS Vrtáky do skla a keramiky
 RO Set burghie pt. sticla si ceramica
 HU Üveg és kerámi fúrók
 ES Juego de brocas, ceramica



STWOR

No.	Ø [mm]	pcs / szt.	
21709	4, 5, 6, 8, 10	5	25/100

EN Depth collars for drills
 PL Ograniczniki głębokości wiercenia
 DE Bohrtiefenbegrenzersatz
 RU Ограничители глубины сверления
 CS Omezovače hloubky vrtání
 RO Limitator adancime pt. burghiu
 HU Mélységűtközők
 ES Topes de profundidad para brocas



VOREL

No.	Ø [mm]	pcs / szt.	
24070	3, 4, 5, 6, 8, 10, 12, 16	8	20/120

EN Dowel set
 PL Zestaw narzędzi do połączeń kołkowych
 DE Werkzeugsatz für Dübelverbindungen
 RU Набор инструментов для дюбельных соединений
 CS Sada nářadí pro kolikové spoje
 RO Set burghiu + cepi de lemn
 HU Készlet fatipilis rögzítésekhez
 ES Kit de herramientas para clavijas

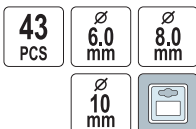

INCLUDED:

- 30 pcs of wood dowel pins: 6 x 30 mm, 8 x 40 mm, 10 x 40 mm
- 6 pcs of dowelling centre points: 6, 8, 10 mm
- 3 pcs of drill stops: 6, 8, 10 mm
- 3 pcs of brad point drill bits: 6, 8, 10 mm
- Hex key

W ZESTAWIE:

- 30 kołków drewnianych rowkowanych: 6 x 30 mm, 8 x 40 mm, 10 x 40 mm
- 6 znaczników: 6, 8, 10 mm
- 3 ograniczniki głębokości wiercenia: 6, 8, 10 mm
- 3 wiertła do drewna: 6, 8, 10 mm
- Klucz imbusowy



VOREL

No.	Ø [mm]	pcs / szt.	
24080	6, 8, 10	43	6/24

EN Tool drill guide
 PL Szablon do wyznaczania otworów
 DE Schablone zur Markierung von Löchern
 RU Шаблон для разметки отверстий
 CS Šablona pro značení otvorů
 RO Instrument ghidare pt. gaurire
 HU Nyílászablon
 ES Plantilla para determinar perforaciones

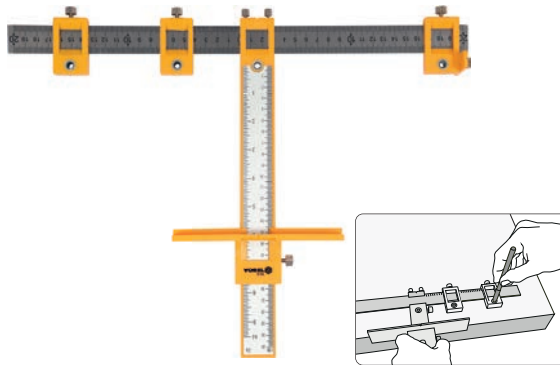

VOREL

No.	L [mm]	
18180	200 (ramię poziome), 250 (listwa pionowa)	40

EN Dowelling centre points
 PL Znaczniki do wyznaczania otworów
 DE Holzdübel-Markierspitzen
 RU Набор кернов для мебельных шкантов
 CS Značící hroty pro kolikování
 RO Cep pt. centrare
 HU Típi jelölő
 ES Centradores

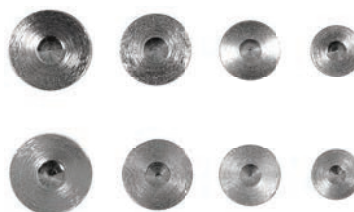

VOREL

No.	Ø [mm]	pcs / szt.	
24060	6 x 2, 8 x 2, 10 x 2, 12 x 2	8	20/120

EN Hand taps
 PL Gwintowniki
 DE Handgewindebohrer
 RU Метчик
 CS Závitníky
 RO Tarozi
 HU Menetfúró
 ES Machos de roscar



No.	Size / Rozmiar	pcs / szt.	
24300	M3	3	25/100
24310	M4	3	25/100
24320	M5	3	25/100
24330	M6	3	25/100
24340	M7	3	25/100
24350	M8	3	25/100
24370	M10	3	25/100
24390	M12	3	25/100
24410	M14	3	20
24430	M16	3	20
24450	M18	3	20
24470	M20	3	20

EN Machine taps
 PL Gwintownik maszynowy
 DE Maschinengewindebohrer
 RU Метчик машинный

CS Strojní závitník
 RO Tarod de mașină
 HU Gépi menetfűrő
 ES Macho mecanico



cztool

No.	Size / Rozmiar	
24960	M3	25/100
24961	M4	25/100
24962	M5	25/100
24963	M6	25/100
24964	M8	25/100
24965	M10	25/100
24966	M12	25/100

EN Hand tap set
 PL Komplet gwintowników
 DE Innengewindebohrersatz
 RU Набор метчиков
 CS Souprava závitníků
 RO Set de tarozi
 HU Menetfűrő készlet
 ES Juego de machos de roscar



cztool

No.	Size / Rozmiar	pcs / szt.	
24940	M3, M4, M5, M6, M7, M8, M10, M12	25	60

EN Ratchet tap wrench
 PL Grzechotka do gwintownika
 DE Gewindebohrerratsche
 RU Вороток для метчиков с трещоткой
 CS Řečtačka na závitník
 RO Cheie cu clichet pt. tarod
 HU Racsnis hajtószer menetfűrőhöz
 ES Carraca para macho de roscar



No.	Size / Rozmiar	
24700	M3-M8	25/100
24710	M5-M12	25/100

EN Circular die
 PL Narzynka
 DE Schneideisen
 RU Плашка
 CS Kruhová závitová čelist
 RO Filieră
 HU Menetvágó
 ES Cojinete de roscar



cztool

No.	Size / Rozmiar	
24500	M3	25/100
24510	M4	25/100
24520	M5	25/100
24530	M6	25/100
24550	M8	25/100
24570	M10	25/100
24590	M12	25/100
24610	M14	25/100
24630	M16	15/60
24650	M18	15/60
24670	M20	15/60

EN Tap and die set
 PL Komplet gwintowników i narzynek
 DE Gewindeschneidwerkzeugsatz
 RU Набор плашек и метчиков
 CS Souprava závitníků a kruhových závitových čelistí
 RO Set de tarozi și filiere
 HU Menetfűrő és menetvágó készlet
 ES Juego de machos de roscar y cojinetes

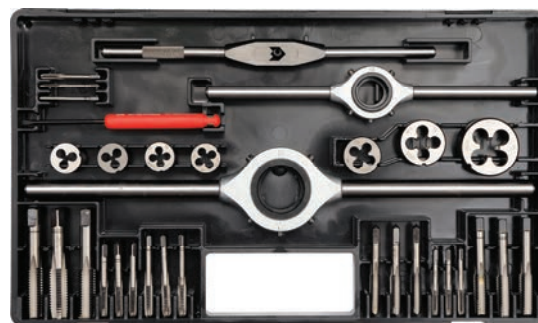

cztool

No.	Size / Rozmiar	pcs / szt.	
24900	M3, M4, M5, M6, M8, M10, M12	32	5

EN Tap wrench
 PL Pokrętko do gwintownika
 DE Windeisen
 RU Вороток для метчиков
 CS Ovládací kolečko na závitník
 RO Cheie (măner) pt. tarod
 HU Hajtószer menetfűrőhöz
 ES Llave giramachos



No.	Size / Rozmiar	
24730	M4-M8	30
24740	M9-M12	25
24750	M13-M18	20

- EN Die holder
- PL Oprawka do narzynek
- DE Schneisenhalter
- RU Плашкодержатель
- CS Závrtová objímka
- RO Portfilieră
- HU Menetvágó tartó
- ES Portacójinete



No.	Size / Rozmiar	
24800	M3-M6	30
24810	M7-M9	25
24813	M10-M11	25
24820	M12-M14	30
24823	M15-M16	20

- EN Screw extractor set
- PL Wykrętki do zerwaných šrub
- DE Schraubenausdreheratz
- RU Набор для извлечения обломанных болтов
- CS Vrtáky do přetržených šroubu
- RO Capete pt. deşurubat şuruburi rupte
- HU Törtcsavar kiszedő készlet
- ES Destornillador para tornillos arrancados



No.	Size / Rozmiar	pcs / szt.	
24000	1/8" (3.2 mm) - 1/4" (6.3 mm), 1/4" (6.3 mm) - 5/16" (7.9 mm), 5/16" (7.9 mm) - 7/16" (11.1 mm), 7/16" (11.1 mm) - 9/16" (14.3 mm), 9/16" (14.3 mm) - 3/4" (19.0 mm)	5	12/120

- EN Router bit set
- PL Zestaw frezów do drewna
- DE Oberfräsersatz
- RU Набор фрез по дереву
- CS Souprava frézů do dřeva
- RO Set de freze pt. lemn
- HU Medtjo frez komplextas
- ES Juego de frezas para madera



No.	Ø [mm]	Toolholder size / Rozmiar uchwyty narzędziowego [mm]	pcs / szt.	
22551	15, 20, 25, 30, 35	8	5	5/20

- EN Tap and die set
- PL Komplet gwintowników i narzynek
- DE Gewindeschneidwerkzeugsatz
- RU Набор плашек и метчиков
- CS Souprava závitníků a kruhových závitových čelistí
- RO Set de tarozi și filiere
- HU Menetfűrő és menetvágó készlet
- ES Juego de machos de rosar y cojinetes



No.	Size / Rozmiar	
24295	M3, M4, M5, M6, M8, M10, M12, M3-M12, M3-M12	10/20

- EN Router bit set
- PL Zestaw frezów do drewna
- DE Oberfräsersatz
- RU Набор фрез по дереву
- CS Souprava frézů do dřeva
- RO Set de freze pt. lemn
- HU Medtjo frez komplextas
- ES Juego de frezas para madera



No.	Toolholder size / Rozmiar uchwyty narzędziowego [mm]	pcs / szt.	
22550	8	12	5/20

- EN Rotary file set
- PL Tamiki trzpieniowe
- DE Profil-Fräser Satz
- RU Набор фрез
- CS Hrotové rašple
- RO Raşpeluri cu coadă
- HU Fareszelőkészlet, csapszárás
- ES Rotatorio archivos



No.	pcs / szt.	
25405	6	50/300

EN Diamond blade segmented
 PL Tarcza diamentowa "segment"
 DE Diamanttrennscheibe
 RU Диск алмазный сегментированный

CS Diamantový kotouč segmentový
 RO Disc diamentat segmentat
 HU Szegmens gyémántkorong
 ES Disco de diamante de segmentos



No.	Ø [mm]	max C [min ⁻¹]	
08711	115	12000	20/200
08712	125	11000	20/160
08714	180	8000	15/60
08715	230	6500	10/40

EN Diamond blade continuous rim
 PL Tarcza diamentowa pełna
 DE Diamanttrennscheibe
 RU Диск алмазный сплошной

CS Diamantový kotouč /plný/
 RO Disc diamentat margine continua
 HU Gyémántkorong /teljes/
 ES Disco de diamante /entero/



No.	Ø [mm]	max C [min ⁻¹]	
08731	115	12000	20/200
08732	125	11000	20/160
08734	180	8000	15/60
08735	230	6500	10/40

EN Diamond blade „Turbo“
 PL Tarcza diamentowa „Turbo“
 DE Diamanttrennscheibe „Turbo“
 RU Отрезной алмазный диск „TURBO“

CS Diamantový kotouč /Turbo/
 RO Disc diamentat Turbo
 HU Gyémántkorong /Turbo/
 ES Disco de diamante /Turbo/



No.	Ø [mm]	max C [min ⁻¹]	
08751	115	12000	20/200
08752	125	11000	20/160
08754	180	8000	15/60
08755	230	6500	10/40

EN Diamond blade segmented
 PL Tarcza diamentowa "segment"
 DE Diamanttrennscheibe
 RU Диск алмазный сегментированный

CS Diamantový kotouč segmentový
 RO Disc diamentat segmentat
 HU Szegmens gyémántkorong
 ES Disco de diamante de segmentos



No.	Ø [mm]	Mounting hole diameter / Średnica mocowania [mm]	Cutting segment thickness / Grubość segmentu tnącego [mm]	Cutting segment height / Wysokość segmentu tnącego [mm]	max C [min ⁻¹]	
08780	115	22.2	1.9	7	13200	20/120
08781	125	22.2	2.0	7	12000	20/120
08782	180	22.2	2.3	7	8400	15/45
08783	230	22.2	2.4	7	6600	10/30

EN Diamond blade continuous rim
 PL Tarcza diamentowa pełna
 DE Diamanttrennscheibe
 RU Диск алмазный сплошной

CS Diamantový kotouč /plný/
 RO Disc diamentat margine continua
 HU Gyémántkorong /teljes/
 ES Disco de diamante /entero/



No.	Ø [mm]	Mounting hole diameter / Średnica mocowania [mm]	Cutting segment thickness / Grubość segmentu tnącego [mm]	Cutting segment height / Wysokość segmentu tnącego [mm]	max C [min ⁻¹]	
08785	115	22.2	1.9	5	13200	20/120
08786	125	22.2	2.0	5	12000	20/120
08787	180	22.2	2.3	5	8400	15/45
08788	230	22.2	2.4	5	6600	10/30

EN Diamond blade „Turbo“
 PL Tarcza diamentowa „Turbo“
 DE Diamanttrennscheibe „Turbo“
 RU Отрезной алмазный диск „TURBO“

CS Diamantový kotouč /Turbo/
 RO Disc diamentat Turbo
 HU Gyémántkorong /Turbo/
 ES Disco de diamante /Turbo/



No.	Ø [mm]	Mounting hole diameter / Średnica mocowania [mm]	Cutting segment thickness / Grubość segmentu tnącego [mm]	Cutting segment height / Wysokość segmentu tnącego [mm]	max C [min ⁻¹]	
08790	115	22.2	2.0	7.0	13200	20/120
08791	125	22.2	2.1	7.0	12000	20/120
08792	180	22.2	2.4	7.5	8400	15/45
08793	230	22.2	2.6	7.5	6600	10/30

- EN Diamond rod saw
- PL Brzeszczot diamentowy
- DE Diamantsägekordel
- RU Полотно алмазное
- CS Lanko pivoie diamentowe
- RO Panze diamentate
- HU Fűrészlap-pálca, gyémántbevonatú
- ES Hoja de sierra de diamante



No.	L [mm]	
27575	300	20/100

- EN TCT circular saw blade for aluminium
- PL Pila tarczowa do aluminium z węglikiem wolframu
- DE Hartmetallbestückt Kreissägeblatt für Aluminium
- RU Диск пильный по алюминию
- CS Kotoúčová pila na hliník s karbidem wolframu
- RO Disc circular pt. aluminii
- HU Wolframkarbidos körfűrészlap, alumíniumhoz
- ES Disco de sierra con carbono

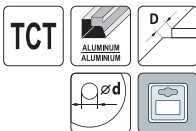

No.	Ø [mm]	Ød [mm]	max C [min ⁻¹]	Cutting segment thickness / Grubość segmentu tnącego [mm]	Metal disc thickness / Grubość tarczy [mm]	T	
08853	210	30	6500	2.2	1.6	72	10/20
08854	250	30	5400	3.0	1.8	100	10/20
08855	300	30	4500	3.2	2.0	100	10

- EN Metal cutting disc
- PL Tarcza do cięcia metalu
- DE Trennscheibe für metall
- RU Диск отрезной по металлу
- CS Souprava kotoúčů pro řezání kovu
- RO Set de pânze de tăiat metal
- HU Vágókorong készlet fémhez
- ES Disco cortador para metalo plano



No.	Ø [mm]	Mounting hole diameter / Średnica mocowania [mm]	Cutting segment thickness / Grubość segmentu tnącego [mm]	max C [min ⁻¹]	
08630	115	22	1.0	12000	25/200
08633	115	22	2.5	13300	25/200
08631	125	22	1.0	11000	25/200
08635	125	22	2.5	12200	25/200
08639	230	22	1.6	6600	25/50
08640	230	22	3.2	6600	25/50
08641	230	22	2.5	6600	25/50
08642	300	32	3.2	5100	10/20
08644	350	32	3.5	4400	10/20
08646	400	32	4.0	3800	10/20

- EN TCT circular saw blade for wood
- PL Pila tarczowa do drewna z węglikiem wolframu
- DE Kreissägeblatt HM-Bestückt
- RU Диск пильный с карбидом вольфрама
- CS Kotoúčová pila na dřevo z karbidem wolframu
- RO Ferăstrău circular cu dinți din wolfram pt. lemn
- HU Wolframkarbidos körfűrész fához
- ES Disco de sierra con carbono de tungsteno



No.	Ø [mm]	Ød [mm]	max C [min ⁻¹]	Cutting segment thickness / Grubość segmentu tnącego [mm]	Metal disc thickness / Grubość tarczy [mm]	T	
08811	140	20	9600	2.0	1.3	16	25/50
08819	160	20	8300	2.0	1.4	18	25/50
08820	160	30	8300	2.0	1.4	24	25/50
08821	160	30	8300	2.0	1.4	36	25/50
08822	160	20	8300	2.0	1.4	48	25/50
08825	184	30	7400	2.2	1.4	24	10/20
08827	184	30	7400	2.2	1.4	40	10/20
08828	185	20	7400	2.2	1.4	18	10/20
08829	200	30	6500	2.2	1.6	24	10/20
08831	210	30	6500	2.2	1.6	40	10/20
08832	210	30	6500	2.2	1.6	60	10/20
08833	250	30	5400	3.0	1.8	24	10/20
08834	250	30	5400	3.0	1.8	40	10/20
08835	250	30	5400	3.0	1.8	60	10/20
08837	300	30	4500	3.2	2.0	40	10
08838	300	30	4500	3.2	2.0	60	10
08845	350	30	3800	3.2	2.2	40	10
08851	400	30	3300	3.2	2.2	60	10

- EN Metal cutting disc
- PL Tarcza do cięcia metalu
- DE Trennscheibe für Metall
- RU Диск отрезной по металлу
- CS Souprava kotoúčů pro řezání kovu
- RO Set de pânze de tăiat metal
- HU Vágókorong készlet fémhez
- ES Disco cortador para metalo plano



No.	Ø [mm]	Mounting hole diameter / Średnica mocowania [mm]	Cutting segment thickness / Grubość segmentu tnącego [mm]	max C [min ⁻¹]	
08170	115	22	1.0	13200	25/200
08174	115	22	3.0	13200	25/200
08171	125	22	1.0	12200	25/200
08175	125	22	3.0	12200	25/200

EN Metal grinding disc - depressed centre
 PL Tarcza do szlifowania metalu wypukła
 DE Metall-Schleifscheibe gewölbt
 RU Диск шлифовальный по металлу

CS Kotouč pro broušení kovu
 RO Disc pt. șlefuit metal
 HU Vágókorong fémhez
 ES Disco de pulir de metal



No.	Ø [mm]	Mounting hole diameter / Średnica mocowania [mm]	Cutting segment thickness / Grubość segmentu tnącego [mm]	max ω [min ⁻¹]	
08663	115	22	6.0	13300	25/100
08665	125	22	6.8	11000	25/100
08669	230	22	6.8	6600	25/50

EN Stone cutting disc
 PL Tarcza do cięcia kamienia
 DE Stein-Trennscheibe
 RU Диск отрезной по камню
 CS Kotouč pro řezání kamene
 RO Disc pt. tăiat piatră
 HU Vágókorong kőhöz
 ES Disco cortador de piedra



No.	Ø [mm]	Mounting hole diameter / Średnica mocowania [mm]	Cutting segment thickness / Grubość segmentu tnącego [mm]	max ω [min ⁻¹]	
08671	115	22	3.2	13200	25/200
08672	125	22	3.2	12200	25/200
08674	230	22	3.2	6600	25/50

EN Abrasive disc
 PL Ściernica listkowa talerzowa
 DE Lameller
 RU Диск лепестковый
 CS Kotouč brusný lamelový
 RO Disc abraziv
 HU Lamellás csiszoló
 ES Disco abrasivo



No.	Grit / Ziarnistość	Ø [mm]	max ω [min ⁻¹]	
07974	P40	115	13300	50/200
07984	P40	125	12300	50/200
07975	P60	115	13300	50/200
07985	P60	125	12300	50/200
07976	P80	115	13300	50/200
07986	P80	125	12300	50/200
07977	P100	115	13300	50/200
07987	P100	125	12300	50/200
07978	P120	115	13300	50/200
07988	P120	125	12300	50/200

EN Metal grinding disc - depressed centre
 PL Tarcza do szlifowania metalu wypukła
 DE Metall-Schleifscheibe gewölbt
 RU Диск шлифовальный по металлу выпуклый
 CS Kotouč pro broušení kovu
 RO Disc pt. șlefuit metal
 HU Vágókorong fémhez
 ES Disco de pulir de metal



No.	Ø [mm]	Mounting hole diameter / Średnica mocowania [mm]	Cutting segment thickness / Grubość segmentu tnącego [mm]	max ω [min ⁻¹]	
08190	115	22	6	13200	25/100
08191	125	22	6	12200	25/100

EN Stone grinding disc - depressed centre
 PL Tarcza do szlifowania kamienia wypukła
 DE Stein- Schleifscheibe gewölbt
 RU Диск шлифовальный по камню
 CS Kotouč pro broušení kamene
 RO Disc pt. șlefuit piatră
 HU Csiszolókorong kőhöz
 ES Disco de pulir de piedra



No.	Ø [mm]	Mounting hole diameter / Średnica mocowania [mm]	Cutting segment thickness / Grubość segmentu tnącego [mm]	max ω [min ⁻¹]	
08683	125	22	6.8	11000	25/100



EN Grinding disc
 PL Tarcza do szlifierki stołowej
 DE Schleifscheibe
 RU Круг для настольного точильного станка
 CS Brusný kotouč
 RO Discul abraziv
 HU Kőszőrűkő
 ES Disco abrasivo



VOREL

No.	Ø [mm]	Mounting hole diameter / Średnica mocowania [mm]	Thickness / Grubość [mm]	max C [min ⁻¹]	
08876	200	20	40	3850	5

EN Figure tin snips
 PL Nożyce do blachy
 DE Blechscherer
 RU Ножницы по металлу
 CS Nůžky na plech
 RO Foarfece pt. tablă
 HU Lemezvágó olló
 ES Tijeras para hojalata



VOREL

No.	L [mm]	Max. cutting capacity in cold-rolled steel / Maks. grubość cięcia w stali walcowanej na zimno [mm]	
48000	250	1.5	6/36

EN Figure tin snips
 PL Nożyce do blachy
 DE Blechscherer
 RU Ножницы по металлу
 CS Nůžky na plech
 RO Foarfece pt. tablă
 HU Lemezvágó olló
 ES Tijeras para hojalata



VOREL

No.	L [mm]	Max. cutting capacity in cold-rolled steel / Maks. grubość cięcia w stali walcowanej na zimno [mm]	
48080	250	1	6/36

EN Grinding disc
 PL Tarcza do szlifierki stołowej
 DE Schleifscheibe
 RU Круг для настольного точильного станка
 CS Brusný kotouč
 RO Discul abraziv
 HU Kőszőrűkő
 ES Disco abrasivo



VOREL

No.	Ø [mm]	Mounting hole diameter / Średnica mocowania [mm]	Thickness / Grubość [mm]	max C [min ⁻¹]	Grit / Ziarnistość	
08860	125	12.7	17	5850	gruboziairny	10
08861	125	12.7	17	5850	drobnoziairny	10
08864	150	12.7	16	5350	gruboziairny	10
08865	150	12.7	17	5350	drobnoziairny	10
08868	150	31.8	25	5350	gruboziairny	10
08869	150	31.8	25	5350	drobnoziairny	10
08873	200	15.9	20	3850	drobnoziairny	10
08875	200	31.8	30	3850	drobnoziairny	10

EN Figure tin snips
 PL Nożyce do blachy
 DE Blechscherer
 RU Ножницы по металлу
 CS Nůžky na plech
 RO Foarfece pt. tablă
 HU Lemezvágó olló
 ES Tijeras para hojalata



VOREL

No.	L [mm]	Max. cutting capacity in cold-rolled steel / Maks. grubość cięcia w stali walcowanej na zimno [mm]	
48060	250	1.2	6/48

EN Figure tin snips
 PL Nożyce do blachy
 DE Blechscherer
 RU Ножницы по металлу
 CS Nůžky na plech
 RO Foarfece pt. tablă
 HU Lemezvágó olló
 ES Tijeras para hojalata



No.	L [mm]	
48100	250	6/60

EN Figure tin snips
 PL Nożyce do blachy
 DE Blechscherer
 RU Ножницы по металлу
 CS Nůžky na plech
 RO Foarfece pt. tablă
 HU Lemezvágó olló
 ES Tijeras para hojalata



VOREL

No.	L [mm]	Max. cutting capacity in cold-rolled steel / Maks. grubość cięcia w stali walcowanej na zimno [mm]	
48082	250	1	6/36

EN Figure tin snips
 PL Nożyce do blachy
 DE Blechscherer
 RU Ножницы по металлу
 CS Nůžky na plech
 RO Foarfece pt. tablă
 HU Lemezvágó olló
 ES Tijeras para hojalata



VOREL

No.	L [mm]	Max. cutting capacity in cold-rolled steel / Maks. grubość cięcia w stali walcowanej na zimno [mm]	
48050	250	1.5	6/36

EN Figure tin snips
 PL Nożyce do blachy
 DE Blechscherer
 RU Ножницы по металлу
 CS Nůžky na plech
 RO Foarfece pt. tablă
 HU Lemezvágó olló
 ES Tijeras para hojalata



VOREL

No.	L [mm]	Max. cutting capacity in cold-rolled steel / Maks. grubość cięcia w stali walcowanej na zimno [mm]	
48081	250	1	6/36

EN Figure tin snips
 PL Nożyce do blachy
 DE Blechscherer
 RU Ножницы по металлу
 CS Nůžky na plech
 RO Foarfece pt. tablă
 HU Lemezvágó olló
 ES Tijeras para hojalata



No.	L [mm]	pcs / szt.	
48330	250	3	5/20

EN Figure tin snips
 PL Nożyce do blachy
 DE Blechscherer
 RU Ножницы по металлу
 CS Nůžky na plech
 RO Foarfece pt. tablă
 HU Lemezvágó olló
 ES Tijeras para hojalata



No.	L [mm]	
48200	250	6/60

EN Figure tin snips
 PL Nożyce do blachy
 DE Blechscherer
 RU Ножницы по металлу
 CS Nůžky na plech
 RO Foarfece pt. tablă
 HU Lemezvágó olló
 ES Tijeras para hojalata



VOREL

No.	L [mm]	Max. cutting capacity in cold-rolled steel / Maks. grubość cięcia w stali walcowanej na zimno [mm]	
48070	250	1.2	6/48

EN Figure tin snips
 PL Nożyce do blachy
 DE Blechscherer
 RU Ножницы по металлу

CS Nůžky na plech
 RO Foarfece pt. tablă
 HU Lemezvágó olló
 ES Tijeras para hojalata



No.	L [mm]	
48150	250	6/60

EN Bolt cutter
 PL Nożyce do drutu
 DE Drahtschere
 RU Болторез

CS Nůžky na drát
 RO Cleste pt. buioane
 HU Drótvágó olló
 ES Tijeras para alambre



No.	L [mm]	
49200	200	15/60

EN Bolt cutter
 PL Nożyce do prętów
 DE Bolzenschneider
 RU Болторез

CS Nůžky na tyče
 RO Clește pt. buloane
 HU Kábelvágó olló
 ES Tijeras para barras



No.	L [mm]	
49450	450	20
49600	600	1/10

EN Miter shears
 PL Nożyce wielofunkcyjne do węzy, rurek, listew
 DE Mitre Scheren
 RU Ножницы угловые для пластмассовых и резиновых профилей
 CS Úhlové nůžky
 RO Foarfeca de mana pt. taiat garnituri
 HU Gérvágó olló
 ES Tijeras multifuncionales para mangueras, tubos, molduras

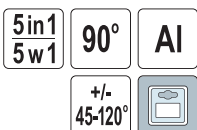

8



No.	Hose diameter / Średnica węza [mm]	
48350	17, 20, 27	6/24

EN Hand saw for wood
 PL Pila do drewna
 DE Handsäge
 RU Пила по дереву

CS Pila na dřevo
 RO Fierastrău „coada de vulpe” - pt. lemn
 HU Fafűrész, egyenes
 ES Sierra de mano



No.	L [mm]	
28380	400	10/40
28381	450	10/40
28382	500	10/40

EN Hand saw for wood
 PL Pila do drewna
 DE Handsäge
 RU Пила по дереву

CS Pila na dřevo
 RO Fierastrău „coada de vulpe” - pt. lemn
 HU Fafűrész, egyenes
 ES Sierra de mano

No.	L [mm]	
28394	400	12/60
28395	450	12/60

EN Bolt cutter
 PL Nożyce do prętów profesjonalne
 DE Bolzenschneider
 RU Болторез „ПРОФИ”
 CS Nůžky na tyče
 RO Clește pt. buloane
 HU Kábelvágó olló
 ES Tijeras para barras



No.	L [mm]	Max. cutting diameter / Maks. średnica cięcia [mm]	
49770	350	6	1/24
49771	450	8	1/12
49772	600	10	1/12
49773	750	12	6
49774	900	14	4
49775	1050	16	2

EN Hand saw for wood
 PL Pila płatnica
 DE Handsäge
 RU Пила по дереву
 CS Pila na dřevo
 RO Fierastrău „coada de vulpe” - pt. lemn
 HU Fafűrész, egyenes
 ES Sierra de mano

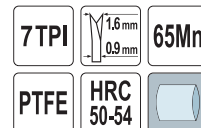

No.	L [mm]	
28385	400	12/48
28386	450	10/40
28387	500	10/40



- EN Bow saw
 PL Pila kabląkowa
 DE Bùgelsäge
 RU Лучковая пила по дереву
- CS Oblouková pila
 RO Ferăstrău de curbură
 HU Keretes fűrész
 ES Sierra de arco



No.	L [mm]	
28740	525	24
28750	750	24

- EN Bow saw
 PL Pila kabląkowa
 DE Bùgelsäge
 RU Лучковая пила по дереву
- CS Oblouková pila
 RO Ferăstrău de curbură
 HU Keretes fűrész
 ES Sierra de arco



No.	L [mm]	
28746	610	12/24
28755	760	12/24

- EN Compass saw
 PL Pila otwornica
 DE Astsäge
 RU Пила выкружная
- CS Pila otvornice
 RO Ferăstrău coadă de șoarece
 HU Lyukfűrész
 ES Sierra compas

300 mm



No.	L [mm]	
28650	300	30/120

- EN Saw for gas concrete
 PL Pila do gazobetonu
 DE Gasbetonsäge
 RU Пила по газобетону с твердосплавным зубом
 CS Pila na plynobeton
 RO Fierastrau cu placute vidia pt. BCA
 HU Fűrész gázbetonhoz
 ES Sierra para gas hormigon



No.	L [mm]	T	
28011	600	15	6/12
28012	660	34	6/12

- EN Bow saw
 PL Pila kabląkowa
 DE Bùgelsäge
 RU Лучковая пила по дереву
 CS Oblouková pila
 RO Ferăstrău de curbură
 HU Keretes fűrész
 ES Sierra de arco



No.	L [mm]	
28745	530	12/24

- EN Spare blade for bow saw
 PL Brzeszczot
 DE Bùgelsägeblatt
 RU Полотно для лучковой пилы по сырому дереву
 CS Ostrí na dřevo
 RO Panza fierastrau tip arc
 HU Fűrészlap fához
 ES Hoja de sierra



No.	L [mm]	W [mm]	
28771	530	20	60/240
28772	610	20	60/240
28773	760	20	60/240

- EN Saw for gas concrete
 PL Pila do gazobetonu
 DE Gasbetonsäge
 RU Пила по газобетону с твердосплавным зубом
 CS Pila na plynobeton
 RO Fierastrau cu placute vidia pt. BCA
 HU Fűrész gázbetonhoz
 ES Sierra para gas hormigon

600 mm



No.	L [mm]	T	
28000	600	33	5
28010	600	17	5

- EN Hacksaw frame
 PL Pila do metalu
 DE Metallsägebogen
 RU Ножовка по металлу
 CS Pila na kov
 RO Ferăstrău pt. metal
 HU Fémfűrész
 ES Sierra de metalo

300 mm



No.	L [mm]	
27000	300	12/48

EN Hacksaw frame
 PL Pila do metalu
 DE Metallsägebogen
 RU Ножовка по металлу
 CS Pila na kov
 RO Ferăstrău pt. metal
 HU Fémfűrész
 ES Sierra de metalo



No.	L [mm]	
27100	250-300	12/60

EN Hacksaw frame
 PL Pila do metalu
 DE Metallsägebogen
 RU Ножовка по металлу
 CS Pila na kov
 RO Ferăstrău pt. metal
 HU Fémfűrész
 ES Sierra de metalo

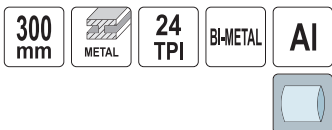

No.	L [mm]	
27322	300	6/36

EN Hacksaw frame
 PL Pila do metalu
 DE Metallsägebogen
 RU Ножовка по металлу
 CS Pila na kov
 RO Ferăstrău pt. metal
 HU Fémfűrész
 ES Sierra de metalo



No.	L [mm]	
27600	150	30/150

EN Multi-functional hand saw with multiple blades
 PL Pila wielofunkcyjna z zestawem akcesoriów
 DE Multifunktionale magische Säge
 RU Многофункциональная волшебная пила

CS Multifunkční ruční dřevěná pila
 RO Fierastrau multifunctional cu lame de rezerva
 HU Varázs fűrész
 ES Sierra mágica multifuncional

INCLUDED:

- Multi-functional hand saw
- 6 universal blades 150 mm for wood, metal and plastics
- 2 diamond blades: round blade for glass and tiles, flat blade 6 mm
- 2 tile cutters
- Frame with round blade for cutting glass and with teeth for breaking glass or tiles
- Wing bolt
- Flat blade 175 x 20 mm for wood and plastics

W ZESTAWIE:

- Pila modelarska
- 6 uniwersalnych brzeszczotów 150 mm do drewna, metalu i tworzyw
- 2 brzeszczoty diamentowe: okrągły do ceramiki i szkła oraz płaski 6 mm
- 2 rysiki do ceramiki
- Rama z okrągłym nożem do cięcia szkła oraz wycięciami do łamania szkła lub ceramiki
- Nakrętka skrzydełkowa
- Brzeszczot płaski 175 x 20 mm do agresywnego cięcia drewna i tworzyw



No.		
27610		30

EN Hacksaw frame
 PL Pila do metalu
 DE Metallsägebogen
 RU Ножовка по металлу
 CS Pila na kov
 RO Ferăstrău pt. metal
 HU Fémfűrész
 ES Sierra de metalo



No.	L [mm]	
27200	300	20/60

EN Hacksaw frame
 PL Pila do metalu
 DE Metallsägebogen
 RU Ножовка по металлу
 CS Pila na kov
 RO Ferăstrău pt. metal
 HU Fémfűrész
 ES Sierra de metalo



No.	L [mm]	
27495	300	5

EN Hack saw set
 PL Zestaw pil do metalu
 DE Metallsägen
 RU Набор пил по металлу
 CS Sada pil na kov
 RO Set bomfaiere
 HU Fémfűrész készlet
 ES Sierras de metal, juego



No.	L [mm]	pcs / szt.	
27333	150, 300, 300	3	6/36



EN Cross - cut saw CS Pila břichatka
 PL Pila poprzeczna RO Joagar
 DE Bauchsäge HU Keresztvágó fűrész
 RU Пила двуручная ES Sierra para corte cruzado

100 cm



VOREL

No.	L [cm]	Type / Typ	
28790	100	L-1000	10

EN Precision miter saw – 2 angles
 PL Pila kątowa uchylna - 2 kąty cięcia
 DE Präzisionsgehrungssäge Kippbar
 RU Стусло металлическое наклонное „ПРОФИ”
 CS Úhlová pila sklápěcí
 RO Fierastru de tăiat la unghi în două plane
 HU Kézfűrész, döntőt
 ES Sierra de ángulo deslizable 2 ángulos de corte

550 mm



VOREL

No.	Saw blade length / Długość brzoźczotu [mm]	Horizontal cutting angle / Kąt cięcia w płaszczyźnie poziomej [°]	
29050	550	45, 55, 60, 72, 90	1

EN Plastic miter box CS Ustřihací skřítka z umělé hmoty
 PL Skrzynka uciosowa RO Cutie din plastic pt. tăiat oblic
 DE Schneidlade HU Vágószablon műanyag
 RU Стусло пластмассовое ES Gria de ingletar de plástico

PS



VOREL

No.	Dimensions / Wymiary [mm]	
29311	250x45	70
29312	285x60	50

EN Precision miter saw
 PL Pila kątowa
 DE Präzisions-Gehrungssäge
 RU Стусло металлическое „ПРОФИ”
 CS Úhlová pila
 RO Fierastru pt. tăiat la unghi
 HU Kézfűrész
 ES Sierra de ángulo

550 mm

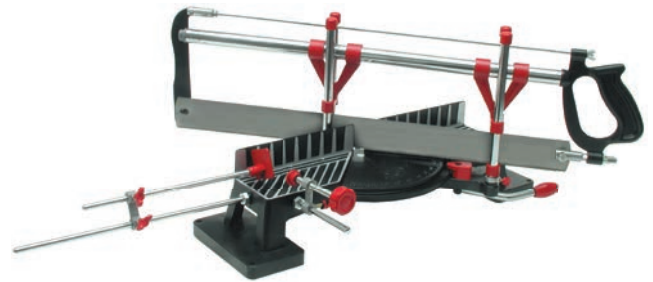

VOREL

No.	Saw blade length / Długość brzoźczotu [mm]	Horizontal cutting angle / Kąt cięcia w płaszczyźnie poziomej [°]	
29000	550	22.5, 30, 36, 45, 90	1

EN Wooden miter box
 PL Drewniana skrzynka uciosowa
 DE Gehrungsschneidlade
 RU Стусло деревянное
 CS Ustřihací skřítka dřevěná
 RO Cutie din lemn pt. tăiat oblic
 HU Vágószablon fa
 ES Gria de ingletar de madera

WOOD DRESSING



VOREL

No.	Dimensions / Wymiary [mm]	
29210	300x80	10
29220	450x105	12

EN Plastic miter box CS Ustřihací skřítka z umělé hmoty
 PL Skrzynka uciosowa RO Cutie din plastic pt. tăiat oblic
 DE Schneidlade HU Vágószablon műanyag
 RU Стусло пластмассовое ES Gria de ingletar de plástico

PS



VOREL

No.	Dimensions / Wymiary [mm]	
29313	280x90	30

EN Plastic miter box
 PL Skrzynka uciosowa
 DE Schneidlade
 RU Крыно пластмассовое

CS Ustřihací skříňka z umělé hmoty
 RO Cutie din plastic pt. tăiat oblic
 HU Vágósablon műanyag
 ES Gria de ingletar de plástico



No.	Dimensions / Wymiary [mm]	
29317	230x50	50
29318	250x65	50
29319	290x85	30

8

EN Sabre saw blades
 PL Brzeszczoty do pily szablastej
 DE Säbelsägeblatt
 RU Пильное полотно
 CS Pilový plátek do pily ocasky
 RO Pânză de ferăstrău sabie
 HU Szablyafűrészlap
 ES Hoja de sierra sable



No.	pcs / szt.	
27850	7	10/100

EN Hacksaw spare blades
 PL Brzeszczoty
 DE Metallsägeblatt
 RU Полотно двустороннее

CS Čepele
 RO Pânze
 HU Fémfűrészlap
 ES Hojas



No.	Type / Typ	L [mm]	W [mm]	pcs / szt.	
27500	RAMb	300	25	72	10

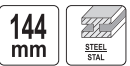

No.	Type / Typ	L [mm]	W [mm]	pcs / szt.	
27502	RAMa	300	12	144	10



No.	Type / Typ	L [mm]	W [mm]	pcs / szt.	
27506	RAMf	300	20	72	10

EN Plastic miter box
 PL Skrzynka uciosowa
 DE Schneidlade
 RU Крыно пластмассовое
 CS Ustřihací skříňka z umělé hmoty
 RO Cutie din plastic pt. tăiat oblic
 HU Vágósablon műanyag
 ES Gria de ingletar de plástico



No.	Dimensions / Wymiary [mm]	
29323	325x125	18

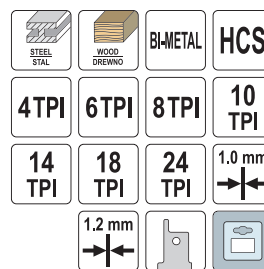

No.	Type / Typ	L [mm]	W [mm]	pcs / szt.	
27501	RAMc	300	12	144	10



No.	Type / Typ	L [mm]	W [mm]	pcs / szt.	
27505	RAMe	300	20	72	10



No.	Type / Typ	L [mm]	W [mm]	pcs / szt.	
27510	RAMd	300	25	72	10

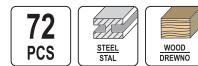

EN Hacksaw spare blades CS Čepele
 PL Brzeszczoły RO Pânze
 DE Metallsägeblatt HU Fémfűrészlap
 RU Полотно двустороннее ES Hojas



No.	Type / Typ	L [mm]	W [mm]	pcs / szt.	
27511	RAMb	300	25	3	50



No.	Type / Typ	L [mm]	W [mm]	pcs / szt.	
27513	RAMd	300	25	3	50

EN Spare blade for precision miter saw for metal
 PL Brzeszczot do metalu
 DE Metallsägeblatt
 RU Полотно для ножовки по металлу
 CS Pílový list na kovy
 RO Panza fierastrau metale o fata taietoare
 HU Fémfűrész lap
 ES Hoja de sierra para metalo



No.	L [mm]	pcs / szt.	
27520	300	12	20/120

EN Spare blade for precision miter saw for wood & PVC
 PL Brzeszczot do drewna i PCV
 DE PVC und Holzsägeblatt
 RU Полотно по дереву и ПВХ
 CS Pílový list na dřevo a PVC
 RO Panza fierastrau pt. lemn si PVC
 HU Fűrészlap fához és PVC-hez
 ES Hoja de sierra para madera y PVC



No.	L [mm]	W [mm]	Thickness / Grubość [mm]	TPI	
29090	550	45	0.7	18	50

EN Hacksaw spare blade RAMb
 PL Brzeszczot RAMb do metalu
 DE Metallsägeblatt RAMb
 RU Полотно двустороннее RAMb
 CS Čepele RAMb
 RO Panza RAMb
 HU Fémfűrészlap RAMf
 ES Hoja de sierra para metalo RAMb



No.	Type / Typ	L [mm]	W [mm]	
27530	RAMb	300	25	70/700

EN Hacksaw spare blade RAMf
 PL Brzeszczot RAMf do drewna i metalu
 DE Metallsägeblatt RAMf
 RU Полотно двустороннее RAMf
 CS Čepele RAMf
 RO Panza RAMf
 HU Fémfűrészlap RAMf
 ES Hoja de sierra para metalo RAMf



No.	Type / Typ	L [mm]	W [mm]	
27533	RAMf	300	20	70/700

EN Hacksaw spare blades
 PL Brzeszczoły
 DE Metallsägeblatt
 RU Полотно по металлу для мини-ножовки
 CS Čepele
 RO Pânze
 HU Fémfűrészlap
 ES Hojas



No.	L [mm]	pcs / szt.	
27800	150	10	8/120

EN Spare blade for precision miter saw for metal
 PL Brzeszczot do metalu
 DE Metallsägeblatt
 RU Полотно по металлу

CS Pílový list na kovy
 RO Panza fierastrau pt. metal
 HU Fémfűrész lap
 ES Hoja de sierra para metalo



No.	L [mm]	W [mm]	Thickness / Grubość [mm]	TPI	
29100	550	45	0.7	32	50

GB Jig saw blades
 PL Brzeszczyty do wyrzynarki elektrycznej
 DE Stichsägeblätter
 RU Полотно для электролобзика

CZ Pilový list do přímočaré pily
 RO Panza fierastrau circular
 HU Dekopírlap
 ES Recambio sierra de calar



VOREL 6TPI 1.5 mm

No.	L [mm]	Working length / Długość robocza [mm]	pcs / szt.	
27811	100	75	5	100/400

VOREL 6TPI 1.2 mm

No.	L [mm]	Working length / Długość robocza [mm]	pcs / szt.	
27813	100	75	5	100/400

VOREL 10TPI 1.5 mm

No.	L [mm]	Working length / Długość robocza [mm]	pcs / szt.	
27815	100	75	5	100/400

5 PCS

VOREL 6TPI 1.2 mm

No.	L [mm]	Working length / Długość robocza [mm]	pcs / szt.	
27830	100	75	5	100/400

VOREL 6TPI 1.5 mm

No.	L [mm]	Working length / Długość robocza [mm]	pcs / szt.	
27831	100	75	5	100/400

VOREL 21TPI 1.0 mm

No.	L [mm]	Working length / Długość robocza [mm]	pcs / szt.	
27832	76	50	5	100/400

VOREL 10TPI 1.5 mm

No.	L [mm]	Working length / Długość robocza [mm]	pcs / szt.	
27833	100	75	5	100/400

VOREL

No.	L [mm]	Working length / Długość robocza [mm]	pcs / szt.	
27834	100, 100, 76, 100, 70	75, 75, 50, 75, 45	5	100/400

5 PCS

VOREL 10TPI 1.5 mm

No.	L [mm]	Working length / Długość robocza [mm]	pcs / szt.	
27810	100	75	5	100/400

VOREL 8TPI 1.2 mm

No.	L [mm]	Working length / Długość robocza [mm]	pcs / szt.	
27812	100	75	5	100/400

VOREL 21TPI 1.0 mm

No.	L [mm]	Working length / Długość robocza [mm]	pcs / szt.	
27814	76	50	5	100/400

VOREL

No.	L [mm]	Working length / Długość robocza [mm]	pcs / szt.	
27820	100, 100, 100, 76, 100	75, 75, 75, 50, 75	5	100/400

GB Jig saw blades
 PL Brzeszczyty do wyrzynarki elektrycznej
 DE Stichsägeblätter
 RU Полотно для электролобзика
 CZ Pilový list do přímočaré pily
 RO Panza fierastrau circular
 HU Dekopírlap
 ES Recambio sierra de calar

EN Steel wire brush
 PL Szczotka druciana
 DE Stahdrahtbürste
 RU Щетка проволочная стальная
 CS Drátěný kartáč
 RO Perie de sármă
 HU Drótkéfe
 ES Cepillo de acero



VOREL

No.	Row quantity / Liczba rzędów	
06930	3	12/120
06940	4	12/120
06950	5	12/120
06960	6	12/120

3 PCS BRASS MOSIADZ STEEL STAL NYLON

EN Plastic handle wire brush set
 PL Komplet szczotek drucianych
 DE Stahlbürstensatz
 RU Набор 3-х мини-щеток
 CS Kartáče
 RO Perie set
 HU 3 db-os kefekészlet
 ES Juego de 3 cepillos



VOREL

No.	L [mm]	
06963	170	24/240
06964	220	24/72

EN Brass wire brush
 PL Szczotka druciana mosiężna
 DE Messingdrahtbürste
 RU Щетка проволочная латунная
 CS Drátěný kartáč mosazný
 RO Perie de sârmă din alamă
 HU Réz drótkefe
 ES Cepillo de latón



VOREL

No.	Ø [mm]	max. ω [min ⁻¹]	Icon
06965			25/100

EN Circular brush - crimped wire
 PL Szczotka tarczowa, drut karbowany
 DE Stahldraht - Kegelhürste
 RU Щетка-крацевка с гайкой

CS Kotoučový kartáč, rýhovaný drát
 RO Perie rotundă, sârmă ondulată
 HU Tarcás drótkefe, sodrott dróttal
 ES Cepillo redondo de alambre ondulado



VOREL

No.	Ø [mm]	max. ω [min ⁻¹]	Icon
06972	100	12500	12/72
06973	115	12500	12/72

EN Circular brush - twisted wire
 PL Szczotka tarczowa z gwintem, drut splatany
 DE Stahldraht - Zopf-scheibenbürste
 RU Щетка-крацевка-усиленная

CS Kotoučový kartáč, pletený drát
 RO Perie rotativă, sârmă împletită
 HU Tarcás drótkefe, egyenes dróttal
 ES Cepillo redondo de alambre conico



VOREL

No.	Ø [mm]	max. ω [min ⁻¹]	Icon
06977	100	12500	12/48

EN Circular brush - twisted wire
 PL Szczotka tarczowa, drut splatany
 DE Stahldraht - Zopfscheibenbürste
 RU Дисковая щетка витая

CS Kotoučový kartáč
 RO Perie rotativă
 HU Tarcás drótkefe
 ES Cepillo redondo de alambre conico



VOREL

No.	Ø [mm]	max. ω [min ⁻¹]	Icon
06981	100	11000	12/72
06982	115	11000	12/48
06983	150	9000	12/36

EN Cup brush - crimped wire
 PL Szczotka czolowa z gwintem, drut karbowany
 DE Stahldraht - Topfbürste
 RU Щетка-крацевка чашка с гайкой

CS Čelní kartáč, rýhovaný drát
 RO Perie frontală, sârmă ondulată
 HU Homlok drótkefe, sodrott dróttal
 ES Cepillo de copa de alambre ondulado



VOREL

No.	Ø [mm]	max. ω [min ⁻¹]	Icon
06970	75	1200	12/72
06971	100	8500	6/24

EN Cup brush - twisted wire
 PL Szczotka czolowa z gwintem, drut splatany
 DE Stahldraht - Zopfopfbürste
 RU Щетка - крацевка круговая крученая щетка крацевка (чашка)

CS Čelní kartáč, pletený drát
 RO Perie frontală, sârmă împletită
 HU Homlok drótkefe, sodrott dróttal
 ES Cepillo de copa de alambre conico



VOREL

No.	Ø [mm]	max. ω [min ⁻¹]	Icon
06974	65	12500	12/36
06975	80	8500	12/36
06976	100	8500	6/24

EN Circular brush - crimped wire
 PL Szczotka tarczowa, drut karbowany
 DE Stahldraht - Scheibenbürste
 RU Щетка-крацевка латунированная сталь

CS Kotoučový kartáč
 RO Perie rotativă
 HU Tarcás drótkefe
 ES Cepillo redondo de alambre ondulado



VOREL

No.	Ø [mm]	max. ω [min ⁻¹]	Icon
06978	125	6000	12/72
06979	150	6000	12/36
06980	200	4500	12/24

EN Circular brush - crimped wire
 PL Szczotka tarczowa z trzpieniem, drut karbowany
 DE Stahldraht - Scheibenbürste mit Dorn
 RU Щетка-крацевка со стержнем

CS Kotoučový kartáč, z hrotem, rýhovaný drát
 RO Perie rotundă cu soadă sârmă ondulată
 HU Tarcás drótkefe, nyéllel, sodrott dróttal
 ES Cepillo redondo con mandril de alambre ondulado



VOREL

No.	Ø [mm]	max. ω [min ⁻¹]	Icon
06985	75	4500	10/120
06986	100	4500	12/120

- EN Cup brush – crimped wire
 PL Szczotka czolowa z trzpieniem, drut karbowany
 DE Stahldraht - Topfbürste
 RU Щетка-крацовка со стержнем чашка
 CS Čelní kartáč, z hrotem, ryhovaný drát
 RO Perie frontală cu coadă, sârmă ondulată
 HU Homlok drótkefe, nyéllal, sodrott dróttal
 ES Cepillo de copa con mandril, de alambre ondulado



No.	Ø [mm]	max C [min ⁻¹]	
06987	50	4500	10/180
06988	75	4500	12/96

- EN Steel wire brush set
 PL Szczotki druciane okrągłe
 DE Stahldraht - Bürstensatz
 RU Набор щеток
 CS Drátěné kartáče kulaté
 RO Perii de sârmă rotunde
 HU Kerek drótkefe
 ES Cepillos de alambre redondos



No.	max C [min ⁻¹]	
06990	4500	20/120

- EN Circular brush - twisted wire
 PL Szczotka tarczowa z trzpieniem, drut spleatany
 DE Stahldraht-Scheibenbürste
 RU Щетка круговая со стержнем
 CS Okružní kartáč, z hrotem, pletený drát
 RO Perie rotundă pt. bormasina
 HU Tarcás drótkefe, nyéllal, egyenes dróttal
 ES Cepillo redondo



No.	Ø [mm]	max C [min ⁻¹]	
06993	75	12500	30/180

- EN Rotoflex profi
 PL Rotoflex przegubowy
 DE Rotoflex profi
 RU Насадка резиновая с фиксатором угла наклона, с липучкой, для дрели
 CS Kloubový rotoflex
 RO Suport disc abraziv, fixare scai
 HU Csuklós rotoflex
 ES Rotoflex articulado



No.	Ø [mm]	max C [min ⁻¹]	
08300	125	2000	20

- EN Wire brush set
 PL Szczotki druciane z trzpieniem, drut karbowany
 DE Stahldraht-Bürstensatz
 RU Набор щеток-крацовок со стержнем
 CS Okružní kartáč drátěný se stopkou
 RO Set perii sarma ondulata
 HU Tarcás drótkefe, nyéllal, sodrott dróttal
 ES Cepillos de alambre con mandril



No.	Ø [mm]	max C [min ⁻¹]	
06989	25, 50, 50	4500	12/60

- EN Cup brush – crimped wire
 PL Szczotka czolowa z trzpieniem, drut karbowany
 DE Stahldraht - Topfbürste
 RU Щетка-крацовка „КИСТЬ” со стержнем
 CS Čelní kartáč, z hrotem, ryhovaný drát
 RO Perie frontală cu coadă, sârmă ondulată
 HU Homlok drótkefe, nyéllal, sodrott dróttal
 ES Cepillo de copa con mandril, de alambre ondulado



No.	Ø [mm]	max C [min ⁻¹]	
06992	24	4500	12/96

- EN Cup brush - twisted wire
 PL Szczotka czolowa z trzpieniem, drut spleatany
 DE Stahldraht - Zapfrundbürste
 RU Щетка-крацовка витая со стержнем
 CS Čelní kartáč, z hrotem, pletený drát
 RO Perie frontală cu coadă, sârmă împletită
 HU Homlok drótkefe, nyéllal, egyenes dróttal
 ES Cepillo de copa con mandril de alambre conico



No.	Ø [mm]	max C [min ⁻¹]	
06995	22	4500	24/192
06994	75	12500	12/96

- EN Rubber disc with velcro
 PL Przystawka z rzepem
 DE Klett - Haftstützeller mit Dorn
 RU Насадка резиновая с шестигранным хвостовиком, для дрели
 CS Přídavné zařízení ze zipem
 RO Disc-Suport cu scai pt. hârtie abrazivă rotundă
 HU Kistál tapadókoronggal
 ES Disco de goma con velcro



No.	Ø [mm]	max C [min ⁻¹]	
08312	125	2000	12/120

EN Rubber disc with arbor
 PL Przystawka-dysk z trzpieniem
 DE Klett - Haftsteller + Ersatzdorn
 RU Насадка резиновая с шестигранным хвостовиком, для дрели

CS Nástavec-kotouč s upínacím trmem
 RO Disc cu știft, ajutăj
 HU Csiszoló korong nyéllel
 ES Disco de goma con mandril



No.	Ø [mm]	max. C [min ⁻¹]	
08314	125	3250	20/120

EN Rubber disc for angle grinder and drill machine
 PL Tarcza do szlifierek kątowych i wiertarek
 DE Klett - Haftstützsteller mit Gewindeflansch und Ersatzdorn
 RU Насадка шлифовальная, гайка M14 с липучкой+ переход
 CS Kotouč do úhelníků ze zipem
 RO Suport disc abraziv, fixare scai
 HU Euro lemez élhez, tapadókoronggal
 ES Disco de goma para ancul con mandril



No.	Ø [mm]	max. C [min ⁻¹]	
08316	125	12200	30/120

EN „Multi-disk“ rubber disc with velcro
 PL Tarcza gumowa „multi-dysk“ z rzepem
 DE Gummihafstützteller
 RU Насадка резиновая поворотная с липучкой, для дрели
 CS Terč multi-dysk ze zipem
 RO Suport disc abraziv, fixare scai
 HU Multidisk tárcsa tapadókorong
 ES Multi-disco con velcro



No.	Ø [mm]	max. C [min ⁻¹]	
08350	125	2000	20

EN Rubber disc for angle grinder with velcro
 PL Euro dysk do kątowniki z rzepem
 DE Klett - Haftstützsteller mit Gewindeflansch
 RU Насадка пластиковая жесткая под круг на липучке
 CS Euro disk do úhelníků ze zipem
 RO Euro disc cu scai pt. polizor unghiular
 HU Euro lemez élhez, tapadókoronggal
 ES Disco de goma para angul con velcro



No.	Ø [mm]	max. C [min ⁻¹]	
08500	125	10000	20
08510	150	8500	20

EN Rubber disc for angle grinder with velcro
 PL Euro dysk do kątowniki z rzepem
 DE Klett - Haftsteller + Gewindeflansch
 RU Насадка пластиковая жесткая под круг на липучке

CS Euro disk do úhelníků ze zipem
 RO Suport disc abraziv, fixare scai
 HU Euro lemez élhez, tapadókoronggal
 ES Disco de goma para angul con velcro



No.	Ø [mm]	max. C [min ⁻¹]	
08315	125	12200	30/120

EN Rubber disc for angle grinder with velcro
 PL Tarcza do kątowniki z rzepem
 DE Klett - Gummihafstützteller mit Gewindeflansch
 RU Насадка шлифовальная под круг на липучке
 CS otouč do úhelníků ze zipem
 RO Suport disc abraziv, fixare scai
 HU Euro lemez élhez, tapadókoronggal
 ES Disco para el pulidor angular con sujetador velcro



No.	Ø [mm]	max. C [min ⁻¹]	
08318	125	12500	25/100

EN Rubber disc with velcro
 PL Przystawka z rzepem
 DE Klett - Haftstützteller mit Dorn
 RU Насадка резиновая с хвостовиком и липучкой для дрели
 CS Přídavné zařízení ze zipem
 RO Suport disc abraziv, fixare scai
 HU Kistál tapadókoronggal
 ES Disco de goma con velcro



No.	Ø [mm]	max. C [min ⁻¹]	
08400	125	2000	20
08410	150	2000	20

EN Rubber disc for angle grinder
 PL Euro dysk do kątowniki z trzpieniem
 DE Klett - Haftstützteller mit Gewindeflansch und Ersatzdorn
 RU Насадка шлифовальная, гайка M14 с липучкой + переход
 CS Euro disk do úhelníků
 RO Euro disc cu scai pt. polizor unghiular
 HU Euro lemez élhez, tapadókoronggal
 ES Disco de goma para ancul con mandril



No.	Ø [mm]	max. C [min ⁻¹]	
08501	125	10000	20

- EN Rubber disc for angle grinder with velcro
- PL Tarcza do kątówki z rzepem nr 2
- DE Klett - Gummihafstüttzeller mit Gewindeflansch
- RU Насадка шлифовальная под круг на липучке
- CS Kotouč do úhelníků ze zipem číslo 2
- RO Disc de păslă cu scai nr. 2 pt. polizor unghiular
- HU Euro lemez élhez, tapadókoronggal, 2 sz.
- ES Disco de goma para angul con velcro



PRO
FILL

No.	Ø [mm]	max C [min ⁻¹]	
08511	125	10000	20

- EN Polishing felt disc
- PL Filc polerski na rzep
- DE Filzpolierdisc
- RU Полировальная насадка из фетра на липучке
- CS Leštící plstěnc na zip
- RO Disc pasla de lustruit cu scai
- HU Polirozó filc tapadókoronggal
- ES Fieltro de pulir con velcro



PRO
FILL

No.	Ø [mm]	max C [min ⁻¹]	
08522	125	10000	100

- EN Lock knife
- PL Nóż składany sierpak
- DE Klappmesser
- RU Нож складной
- CS Dřevěný nůž srpek
- RO Cutit secera maner lemn
- HU Hajlított pengéjű kés, fanyelű
- ES Cuchillo falciforme de madera



VOREL

No.	Blade length / Długość ostrza [mm]	
76621	75	10/100

- EN Cable knife
- PL Nóż monterski
- DE Montagemesser
- RU Нож электрика
- CS Montážní nůž
- RO Cutit pt. decablat
- HU Szerelőkés
- ES Cuchillo de montaje



No.	
76640	50

- EN Polishing felt disc
- PL Rzep do tarczy gumowej /przylepiec/
- DE Klett disk für Gummistüttzeller
- RU Круг с липучкой
- CS Zip do pryžového kotouče /suchý zip/
- RO Disc pasla de lustruit cu scai
- HU Tapadókorong gumitárcsához
- ES Velcro para disco de goma



VOREL

No.	Ø [mm]	
08520	150	10/100
08521	125	10/100

- EN Folding knife
- PL Nóż składany
- DE Klappmesser
- RU Нож складной
- CS Kapesní nůž
- RO Briceag
- HU Zsebkés
- ES Navaja



VOREL

No.	Blade size / Rozmiar ostrza [mm]	
76526	61x33x0.5	12/72

- EN Electrician's knife
- PL Nóż monterski składany
- DE Montagemesser
- RU Нож складной
- CS Montážní nůž
- RO Cutit pt. decablat
- HU Szerelőkés
- ES Cuchillo de montaje



VOREL

No.	Blade length / Długość ostrza [mm]	
76622	85	10/100

- EN Cable knife
- PL Nóż monterski
- DE Montagemesser
- RU Нож электрика
- CS Montážní nůž
- RO Cutit pt. decablat
- HU Szerelőkés
- ES Cuchillo de montaje



No.	
76650	50

EN Cable knife
 PL Nóż sierpak
 DE Klappmesser
 RU Нож садовый
 CS Dřevěný nůž srpek
 RO Cutit secera maner lemn
 HU Hajlított pengéjű kés, fanyelű
 ES Cuchillo falciforme de madera



No.	Blade size / Rozmiar ostrza [mm]	For / Dia
76660	50	

EN Spare blades for utility knife
 PL Ostrza zapasowe do nożyka
 DE Ersatz-Kurzklingen für Cuttermesser
 RU Запасные лезвия для ножа
 CS Lomené ostrí náhradní
 RO Lame rezerva pt. cutter metallic
 HU Törhető tartalékpenge
 ES Filos de recambio para cuchillo



No.	Blade size / Rozmiar ostrza [mm]	For / Dia
76010	61x19	76000, 76011, 76015

EN Utility knife
 PL Nożyk z ostrzem trapezowym
 DE Cuttermesser
 RU Нож универсальный
 CS Univerzální nůž s lichoběžníkovou čepelí
 RO Cujiț cu lamă trapezoidală retractabilă
 HU Univerzális kés
 ES Cuchillo con hoja trapezoidal



No.	Blade size / Rozmiar ostrza [mm]	Blade width / Szerokość ostrza [mm]
76015	61x19	12/72

EN Metal utility knife
 PL Nożyk z lamany ostrzem
 DE Abbrechklingen-Messer
 RU Нож строительный
 CS Nůž ulamovací
 RO Cujiț universal (cutter)
 HU Univerzális kés
 ES Cuchillo de papelería



No.	Blade width / Szerokość ostrza [mm]	Blade size / Rozmiar ostrza [mm]
76160	9	24/288

EN Utility knife
 PL Nożyk z ostrzem trapezowym
 DE Cuttermesser
 RU Нож универсальный

CS Univerzální nůž s lichoběžníkovou čepelí
 RO Cujiț cu lamă trapezoidală retractabilă
 HU Univerzális kés
 ES Cuchillo con hoja trapezoidal



No.	Blade size / Rozmiar ostrza [mm]	Blade width / Szerokość ostrza [mm]
76000	61x19	25/200

EN Cutting knife with blade compartment
 PL Nóż instalacyjny z magazynkiem
 DE Universalmesser
 RU Нож обрешителный
 CS Univerzální nůž
 RO Cutter cu maner metallic si compartiment pt. rezerva
 HU Univerzális kés
 ES Cutter con cargador



No.	Blade size / Rozmiar ostrza [mm]	Blade width / Szerokość ostrza [mm]
76011	61x19	12/72

EN Metal utility knife
 PL Nożyk z lamany ostrzem
 DE Abbrechklingen-Messer
 RU Нож строительный
 CS Nůž ulamovací
 RO Cujiț universal (cutter)
 HU Univerzális kés
 ES Cuchillo de papelería



No.	Blade width / Szerokość ostrza [mm]	Blade size / Rozmiar ostrza [mm]
76101	9	60/360

EN Metal utility knife
 PL Nożyk z lamany ostrzem
 DE Abbrechklingen-Messer
 RU Нож строительный
 CS Nůž ulamovací
 RO Cujiț universal (cutter)
 HU Univerzális kés
 ES Cuchillo de papelería



No.	Blade width / Szerokość ostrza [mm]	Blade size / Rozmiar ostrza [mm]
76184	18	12/120

EN Metal utility knife
 PL Nożyk z łamanym ostrzem
 DE Abbrechklingen-Messer
 RU Нож строительный
 CS Nůž ulamovací
 RO Cuițit universal (cutter)
 HU Univerzális kés
 ES Cuchillo de papelería



No.	Blade width / Szerokość ostrza [mm]	
76180	18	40/400

EN Metal utility knife
 PL Nożyk z łamanym ostrzem
 DE Abbrechklingen-Messer
 RU Нож строительный
 CS Nůž ulamovací
 RO Cuițit universal (cutter)
 HU Univerzális kés
 ES Cuchillo de papelería



No.	Blade width / Szerokość ostrza [mm]	
76181	18	50/400

EN Metal utility knife
 PL Nożyk z łamanym ostrzem
 DE Abbrechklingen-Messer
 RU Нож строительный
 CS Nůž ulamovací
 RO Cuițit universal (cutter)
 HU Univerzális kés
 ES Cuchillo de papelería



No.	Blade width / Szerokość ostrza [mm]	
76183	18	24/144

EN Metal utility knife
 PL Nożyk z łamanym ostrzem
 DE Abbrechklingen-Messer
 RU Нож строительный
 CS Nůž ulamovací
 RO Cuițit universal (cutter)
 HU Univerzális kés
 ES Cuchillo de papelería



No.	Blade width / Szerokość ostrza [mm]	
76190	25	12/72

EN Metal utility knife
 PL Nożyk z łamanym ostrzem
 DE Abbrechklingen-Messer
 RU Нож строительный
 CS Nůž ulamovací
 RO Cuițit universal (cutter)
 HU Univerzális kés
 ES Cuchillo de papelería



No.	Blade width / Szerokość ostrza [mm]	
76185	18	60/600

EN Metal utility knife
 PL Nożyk z łamanym ostrzem
 DE Abbrechklingen-Messer
 RU Нож строительный
 CS Nůž ulamovací
 RO Cuițit universal (cutter)
 HU Univerzális kés
 ES Cuchillo de papelería



No.	Blade width / Szerokość ostrza [mm]	
76182	18	24/240

EN Metal utility knife
 PL Nożyk z łamanym ostrzem
 DE Abbrechklingen-Messer
 RU Нож строительный
 CS Nůž ulamovací
 RO Cuițit universal (cutter)
 HU Univerzális kés
 ES Cuchillo de papelería

SK5

AUTO LOCK BLOKADA

ABS

TPR

METAL SLIDING BAR METALOWA PROWADNICA



No.	Blade width / Szerokość ostrza [mm]	
76186	18	12/144

EN Spare blades
 PL Ostrza zapasowe do nożyka
 DE Abbrechklingen
 RU Лезвия для универсальных ножей
 CS Lomené ostří náhradní
 RO Lame de rezervă rupte
 HU Törhető tartalékpenge
 ES Fila partido de recambio

5 PCS



No.	Blade width / Szerokość ostrza [mm]	pcs / szt.	
76214	25	5	36/288

EN Spare blades
 PL Ostrza zapasowe do nożyka
 DE Abbrechklingen
 RU Запасные лезвия
 CS Lomené ostří náhradní
 RO Lame de rezerva pt. cutter
 HU Törhető tartalékpenge
 ES Filo partido de recambio



No.	Blade width / Szerokość ostrza [mm]	pcs / szt.	
76210	9	5	100/600
76220	18	5	100/600

EN Utility knife set
 PL Komplet nożyków
 DE Universal-Messersatz
 RU Набор ножей пистолетных

CS Sada ulamovacích noží
 RO Set cuttere
 HU Univerzális kés és műanyag kaparó készlet
 ES Cuchillos de papelería



No.	pcs / szt.	
76250	5	30/150

EN Glass cutter
 PL Nóż do szkła
 DE Glasschneider
 RU Стеклопез
 CS Nůž do skla
 RO Diamant pt. sticlă
 HU Kés üveghez
 ES Cuchillo para cristal



No.		
05100		12/240

EN Scriber
 PL Rysik traserski
 DE Reißnadel
 RU Чертилка по металлу
 CS Rysovací jehla
 RO Ac detrasat
 HU Karctu
 ES Trazador



VOREL

No.	L [mm]	
35210	140	12/72

EN Utility knife set
 PL Komplet nożyków
 DE Universal-Messersatz
 RU Набор ножей пистолетных
 CS Sada ulamovacích noží
 RO Set cuttere
 HU Univerzális kés készlet
 ES Cuchillos de papelería



No.	pcs / szt.	
76230	3	100/300

EN Window scraper
 PL Skrobak do szyb
 DE Fensterabstreicher
 RU Скребок для стекла
 CS Škrabák na skla
 RO Răzuitor pt. geamuri
 HU Kaparó üveghez
 ES Rascador de cristales



No.	Blade width / Szerokość ostrza [mm]	
06820	60	50/200

EN Oil glass cutter
 PL Nóż olejowy do szkła
 DE Ölglasschneider
 RU Стеклопез масляный
 CS Rezák na sklo
 RO Diamant pt. taiat sticlă cu ulei
 HU Olajkés üveghez
 ES Cuchillo de aceite para cristales



No.		
05050		6/120

EN Automatic center punch
 PL Punktak automatyczny
 DE Automatischer Körner
 RU Автоматический кернер
 CS Automatické důlčičkem
 RO Punctator automat
 HU Automatikus központ puncs
 ES Centro automático punch



VOREL

No.	L [mm]	
35240	140	12/72

- EN Double edge scraper
- PL Cyklina ręczna, drewniana
- DE Schaber
- RU Циклевка с деревянной ручкой
- CS Dřevěná hoblarka ruční
- RO Rascheta dubla (maner lemn)
- HU Kézi, fa simító
- ES Rascador manual de madera



No.	Blade size / Rozmiar ostrza [mm]	
06840	40	10
06860	60	10

- EN Scissors
- PL Nożyczki
- DE Haushaltsschere
- RU Ножницы
- CS Nůžky
- RO Foarfece
- HU Olló
- ES Tijeras



No.	L [mm]	
76311	170	12/144

- EN Scissors set
- PL Komplet nożyczek
- DE Haushaltsscherensatz
- RU Ножницы бытовые в наборе
- CS Nůžky
- RO Foarfece
- HU Olló
- ES Tijeras



No.	L [mm]	pcs / szt.	
76314	140, 170, 190, 220, 250	5	12/24

- EN Leather hole punch & grommet setting tool kit
- PL Zestaw kaletniczy
- DE Taschenr Satz
- RU Набор для установки кнопок и люверсов
- CS Děrovačka na pásky
- RO Set clesti prelucrare piele
- HU Szegecselő és lyukasztó készlet
- ES Kit de cuero herramientas neumáticas de perforación y ojal



No.		
43603		5/20

- EN Wood carving knife set
- PL Komplet nożyków precyzyjnych z ostrzami
- DE Präzisionsmessersatz
- RU Набор ножей для резьбы по дереву
- CS Sada přesných noží s bříty
- RO Set cutite prelucrare lemn
- HU Modellező készlet pengékkel
- ES Juego de cutters precisos con cuchillos



No.	pcs / szt.	
76305	16	25/100

- EN Scissors
- PL Nożyczki
- DE Haushaltsschere
- RU Ножницы
- CS Nůžky
- RO Foarfece
- HU Olló
- ES Tijeras



No.	L [mm]	
76312	220	12/144

- EN Leather hole punch
- PL Dziurkacz nastawny
- DE Einstellbarer Locher
- RU Дырокол pistolенный
- CS Děrovací kleště nastavitelné
- RO Perforator ajustabil
- HU Állítható lyukasztó
- ES Pinza perforadora ajustable

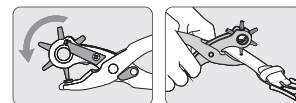

No.	L [mm]	
43600	220	6/36

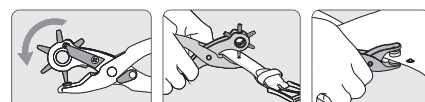

EN Pliers for plastic snaps
 PL Praska do zaciskania nap
 DE Zange für Plastic Moschettoni
 RU Клещи для пластиковых защелками
 CS Pliers pro plastovou nezapadne
 RO Plastic pliers pt. sporturi
 HU Fogó műanyag pattan
 ES Alicates para la snaps de plástico



VOREL

No.	Hole diameter / Średnica otworu [mm]	
76710	10, 12, 14	30/60

EN Punch set
 PL Komplet przebijaaków do skóry
 DE Lederlochereset
 RU Набор пробойников для кожи
 CS Sada průbojníků na kůži
 RO Set preducele
 HU Bőryukasztó készlet
 ES Juego de perforar en piel



No.	Hole diameter / Średnica otworu [mm]	
76700	2, 2.5, 3.2, 4, 4.8, 5.5, 6.4, 8, 9.5, 11.1, 12.7, 14, 15.8, 19, 22	5/20

EN Wood plane
 PL Strug drewniany
 DE Putzhobel
 RU Рубанок отборник деревянный
 CS Dřevěný hoblík
 RO Rindea de lemn
 HU Fagyalu
 ES Cepillo de madera



No.	Blade width / Szerokość ostrza [mm]	
25860	45	30

EN Block plane
 PL Metalowy strug do drewna
 DE Metallhobel für Holz
 RU Металлический рубанок по дереву
 CS Kovový hoblík do dřeva
 RO Rindea
 HU Fémgyalu
 ES Cepillo metálico para madera



VOREL

No.	Blade width / Szerokość ostrza [mm]	
25885	42	50

EN Punch set
 PL Komplet przebijaaków do skóry
 DE Lederlochereset
 RU Набор пробойников для кожи
 CS Sada průbojníků na kůži
 RO Set preducele
 HU Bőryukasztó készlet
 ES Juego de perforar en piel



No.	Hole diameter / Średnica otworu [mm]	
76705	2.5, 3, 4, 5, 6, 7, 8, 9, 10	10/80

EN Rabbet plane
 PL Strug kątnik czolowy
 DE Simshobel
 RU Фальцгребель двойной деревянный
 CS Hoblík čelní drážkovník
 RO Rindea frontală unghiulară
 HU Párkánygyalu, homlok
 ES Cepillo de ranura



No.	Blade width / Szerokość ostrza [mm]	L [mm]	
25830	30	245	20

EN Mini block plane
 PL Metalowy strug modelarski
 DE Metallhobel für Modellbau
 RU Металлический рубанок для моделирования
 CS Kovový modelářský hoblík
 RO Mini rindea
 HU Mini fémgyalu
 ES Cepillo mini



VOREL

No.	Blade width / Szerokość ostrza [mm]	
25881	26	10/50

EN Block plane
 PL Metalowy strug do drewna
 DE Metallhobel für Holz
 RU Металлический рубанок по дереву
 CS Kovový hoblík do dřeva
 RO Rindea
 HU Fémgyalu
 ES Cepillo metálico para madera



VOREL

No.	Blade width / Szerokość ostrza [mm]	
25886	42	36

EN Block plane
 PL Metalowy strug do drewna
 DE Metallhobel für Holz
 RU Металлический рубанок по дереву
 CS Kovový hoblík do dřeva
 RO Rindea
 HU Fémgyalu
 ES Cepillo metálico para madera



No.	Blade width / Szerokość ostrza [mm]	Box icon
25887	44	30

EN Steel file
 PL Piłnik do metalu
 DE Werkstatt-Feile
 RU Напильник слесарный
 CS Piłnik na kov
 RO Pliă de lăcătuşerie
 HU Lakatos reszelő
 ES Lima para metal



No.	L [mm]	Box icon
25161	200	25/100

EN Steel file
 PL Piłnik do metalu
 DE Werkstatt-Feile
 RU Напильник слесарный
 CS Piłnik na kov
 RO Pliă de lăcătuşerie
 HU Lakatos reszelő
 ES Lima para metal



No.	L [mm]	Box icon
25163	200	25/100

EN Steel file set
 PL Zestaw piłników do metalu
 DE Feilensatz
 RU Набор напильников
 CS Piłniky na kov
 RO Pile de lăcătuşerie
 HU Lakatos reszelő készlet
 ES Juego de limas para metal

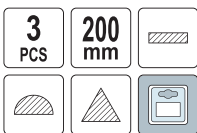

No.	L [mm]	pcs / szt.	Box icon
25165	200	3	10/20

EN Steel file
 PL Piłnik do metalu
 DE Werkstatt-Feile
 RU Напильник слесарный
 CS Piłnik na kov
 RO Pliă de lăcătuşerie
 HU Lakatos reszelő
 ES Lima para metal

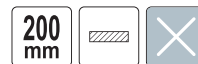

No.	L [mm]	Box icon
25160	200	25/100

EN Steel file
 PL Piłnik do metalu
 DE Werkstatt-Feile
 RU Напильник слесарный
 CS Piłnik na kov
 RO Pliă de lăcătuşerie
 HU Lakatos reszelő
 ES Lima para metal



No.	L [mm]	Box icon
25162	200	25/100

EN Steel file
 PL Piłnik do metalu
 DE Werkstatt-Feile
 RU Напильник слесарный
 CS Piłnik na kov
 RO Pliă de lăcătuşerie
 HU Lakatos reszelő
 ES Lima para metal



No.	L [mm]	Box icon
25164	200	25/100

EN Steel file set
 PL Zestaw piłników do metalu
 DE Feilensatz
 RU Набор напильников
 CS Piłniky na kov
 RO Pile de lăcătuşerie
 HU Lakatos reszelő készlet
 ES Juego de limas para metal

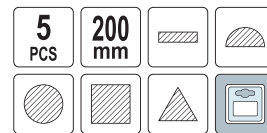

No.	L [mm]	pcs / szt.	Box icon
25166	200	5	10/20

EN Needle file set
 PL Zestaw pilników do metalu „igłaki”
 DE Schlüsselfeileinsatz
 RU Набор напильней

CS Pilníky na kov jehlové
 RO Set de pile lemni - metal
 HU Tűreszelő készlet fémhez
 ES Limas de metalu aguñas



No.	L [mm]	Toolholder size / Rozmiar uchwyty narzędziowego [mm]	pcs / szt.	
25370	150	4	5	20/200
25380	150	4	10	25/100
25390	150	4	12	25/100

EN Needle file set
 PL Zestaw pilników do metalu „igłaki”
 DE Schlüsselfeileinsatz
 RU Набор напильней
 CS Pilníky na kov jehlové
 RO Set de pile lemni - metal
 HU Tűreszelő készlet fémhez
 ES Limas de metalu aguñas

6
PCS



VOREL

No.	L [mm]	pcs / szt.	
25351	140	6	20/160
25352	160	6	20/160
25353	180	6	20/120

EN Diamond whetstone
 PL Osełka diamentowa
 DE Diamant Schleifstein
 RU Алмазный брусок

CS Diamond brousek
 RO Piatra abraziva diamantata
 HU Kétoldalas gyémánt fenőkő
 ES Piedra de afilar diamantada

P400 150x50 mm

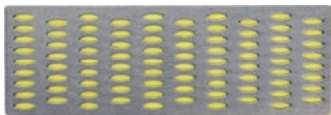

VOREL

No.	Grit / Ziamistość	W [mm]	L [mm]	
26131	P400	50	150	20/100

EN Diamond whetstone set
 PL Zestaw oselek diamentowych
 DE Diamant Schleifstein
 RU Алмазный брусок
 CS Diamond brousek
 RO Piatra abraziva diamantata
 HU Kétoldalas gyémánt fenőkő
 ES Piedra de afilar diamantada

3
PCS 75x25 mm

P180 P260

P360



VOREL

No.	Grit / Ziamistość	W [mm]	L [mm]	
26140	P180, P260, P360	25	75	25/100

EN Needle file set
 PL Zestaw pilników igłaków
 DE Nadelfeileinsatz
 RU Набор напильников надфили
 CS Sada jehlových pilníků
 RO Set pile conice
 HU Tűreszelő készlet
 ES Juego de limas de aguña

6
PCS



No.	pcs / szt.	
25360	6	20/200

EN Diamond whetstone
 PL Osełka diamentowa
 DE Diamant Schleifstein
 RU Алмазный брусок

CS Diamond brousek
 RO Piatra abraziva diamantata
 HU Kétoldalas gyémánt fenőkő
 ES Piedra de afilar diamantada

P600 150x50 mm

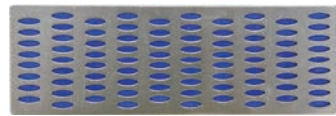

VOREL

No.	Grit / Ziamistość	W [mm]	L [mm]	
26130	P600	50	150	20/100

EN Diamond whetstone
 PL Osełka diamentowa
 DE Diamant Schleifstein
 RU Алмазный брусок

CS Diamond brousek
 RO Piatra abraziva diamantata
 HU Kétoldalas gyémánt fenőkő
 ES Piedra de afilar diamantada

P300 150x50 mm

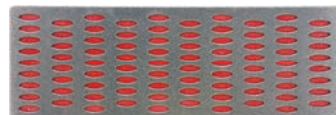

VOREL

No.	Grit / Ziamistość	W [mm]	L [mm]	
26132	P300	50	150	20/100

EN Wood rasp
 PL Tarnik do drewna
 DE Holzraspel
 RU Рашпиль по дереву
 CS Rašple do dřeva
 RO Raspe
 HU Fareszelő
 ES Escarpelo para madera

200 mm



VOREL

No.	L [mm]	
25170	200	25/100

EN Wood rasp
 PL Tarnik do drewna
 DE Holzraspel
 RU Рашиль по дереву
 CS Rašple do dřeva
 RO Raspe
 HU Fareszelő
 ES Escarpelo para madera



VOREL

No.	L [mm]	
25171	200	25/100

EN Wood rasp set
 PL Komplet tarników do drewna
 DE Holzraspelsatz
 RU Рашили для дерева

CS Sada rašplí do dřeva
 RO Set raspe
 HU Fareszelő készlet
 ES Juego de escarpelos para madera



VOREL

No.	L [mm]	pcs / szt.	
25173	200	3	10/20

EN Rasp for plaster
 PL Tarnik do gipsu
 DE Gipskartonplatten Rasp
 RU Рашиль для гипсокартона
 CS Rašple pro omítky
 RO Rindea
 HU Reszelt vakolat
 ES Eliminador de yeso



VOREL

No.	Working width / Szerokość robocza [mm]	L [mm]	
25300	40	60	10/60

EN Rasp for plaster
 PL Tarnik do gipsu
 DE Gipskartonplatten Rasp
 RU Рашиль для гипсокартона
 CS Rašple pro omítky
 RO Rindea
 HU Reszelt vakolat
 ES Eliminador de yeso



VOREL

No.	Working width / Szerokość robocza [mm]	L [mm]	
25307	40	140	15/60

EN Wood rasp
 PL Tarnik do drewna
 DE Holzraspel
 RU Рашиль по дереву
 CS Rašple do dřeva
 RO Raspe
 HU Fareszelő
 ES Escarpelo para madera



VOREL

No.	L [mm]	
25172	200	25/100

EN Wood rasp set
 PL Komplet tarników do drewna
 DE Holzraspelsatz
 RU Рашили для дерева

CS Sada rašplí do dřeva
 RO Set raspe
 HU Fareszelő készlet
 ES Juego de escarpelos para madera



No.	L [mm]	pcs / szt.	
25230	200	3	15/60

EN Blade for rasp
 PL Tarka zapasowa do tarnika
 DE Sägeblatraspel
 RU Лезвие для рашиля по гипсокартону
 CS Čepel do škrabacích
 RO Lama pt. rasp
 HU Penge reszelő
 ES Hoja para raspar

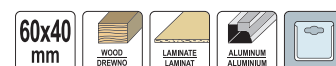

VOREL

No.	Working width / Szerokość robocza [mm]	L [mm]	For / Dla	
25301	40	60	25300	10/120

EN Rasp for plaster
 PL Tarnik do gipsu
 DE Gipskartonplatten Rasp
 RU Рашиль для гипсокартона
 CS Rašple pro omítky
 RO Rindea
 HU Reszelt vakolat
 ES Eliminador de yeso



VOREL

No.	Working width / Szerokość robocza [mm]	L [mm]	
07930	50	140	6/36

EN Rasp for plaster
 PL Tarnik do gipsu
 DE Gipskartonplatten Rasp
 RU Рашпиль для гипсокартона
 CS Rašple pro omítky
 RO Rindea
 HU Reszelt vakolat
 ES Eliminador de yeso

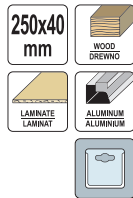

No.	Working width / Szerokość robocza [mm]	L [mm]	
25310	40	250	15/60

EN Sharpening stone
 PL Osełka owalna
 DE Abziehstein
 RU Брусок
 CS Obťahovací brousek
 RO Pila abraziva pt. ascuțit
 HU Feńőkő
 ES Piedra de afilar



No.	L [mm]	
26210	225	50/100

EN Rotary sharpener
 PL Ostrzarka do wiertarki
 DE Bohrschärfer-Bohrmaschinenaufsatz
 RU Точило для ножей и ножниц

CS Brousek na nože a nůžky
 RO Rezerva pt dispozitiv de ascuțit burghie
 HU Élezőkő fűrógépbe fogható
 ES Muela afilar cuchillos y tijeras



No.	
26225	80/240

EN Waterproof sand paper
 PL Papier ścierny wodoodporny
 DE Schleifpapier wasserfest
 RU Бумага наждачная-водостойкая

CS Smirkový papír vodní
 RO Hartie abraziva rezistentă la apa
 HU Csiszolópapír vízes
 ES Papel de lija resistente al agua

No.	Grit / Ziarnistość	Size / Rozmiar [mm]	pcs / szt.	
07060	P60	230x280	50	1000
07080	P80	230x280	50	50/1000
07100	P100	230x280	50	1000
07120	P120	230x280	50	1000
07180	P180	230x280	50	1000
07240	P240	230x280	50	1000
07320	P320	230x280	50	50/1000
07400	P400	230x280	50	1000
07506	P600	230x280	50	1000
07508	P800	230x280	50	1000
07510	P1000	230x280	50	1000
07512	P1200	230x280	50	1000

EN Sharpening stone
 PL Osełka
 DE Abziehstein
 RU Брусок
 CS Obťahovací brousek
 RO Pila abraziva pt. ascuțit
 HU Feńőkő
 ES Piedra de afilar



No.	L [mm]	
26150	150	25/50
26200	200	25/50

EN Knife sharpener
 PL Ostrzarka do noży
 DE Messerschärfer
 RU Точилка для ножей
 CS Brousek na nože
 RO Culiț ascuțitoare
 HU Késélező
 ES Afilador de cuchillos



No.	
26220	12/96

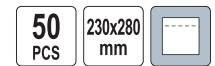
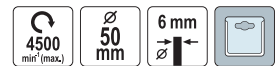
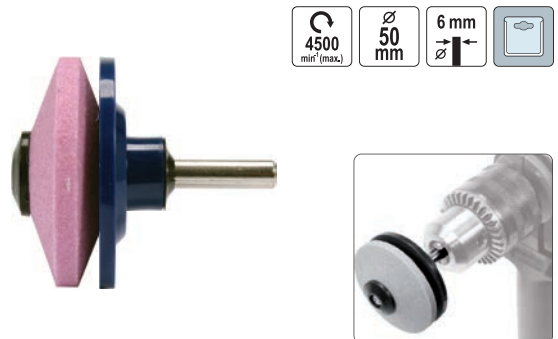

- EN Abrasive cloth
- PL Piótno ściernie
- DE Schleifgewebe
- RU Бумага наждачная на тканевой основе
- CS Brusné pletivo
- RO Pânză abrazivă
- HU Csiszolóvászon
- ES Paño abrasivo



No.	Grit / Ziarnistość	Size / Rozmiar [mm]	pcs / szt.	
07530	P36	230x280	50	500
07540	P46	230x280	50	500
07560	P60	230x280	50	500
07580	P80	230x280	50	500
07610	P100	230x280	50	500
07620	P120	230x280	50	500
07630	P150	230x280	50	500

- EN No end abrasive band
- PL Taśma ścierna bezkońcowa
- DE Schleifband
- RU Лента шлифовальная бесконечная
- CS Pás brusný nekonečný
- RO Banda abraziva
- HU Végtelenített csiszolószalag
- ES Banda abrasiva sin extremos



No.	Grit / Ziarnistość	Size / Rozmiar [mm]	pcs / szt.	
07664	P40	75x533	5	20/60
07665	P60	75x533	5	20/60
07666	P80	75x533	5	20/60
07667	P100	75x533	5	20/60
07668	P120	75x533	5	20/60

- EN Abrasive sponge
- PL Gąbka ścierna
- DE Schleifschwamm
- RU Шлифовальная сетка
- CS Hubka brusná
- RO Burete abraziv
- HU Dörzsszivacs
- ES Esponja abrasiva



No.	Grit / Ziarnistość	Size / Rozmiar [mm]	
07910	P46	124x98x12	100
07911	P60	124x98x12	100
07912	P80	124x98x12	100
07913	P100	124x98x12	100
07914	P120	124x98x12	100
07915	P150	124x98x12	100
07916	P180	124x98x12	100

- EN Abrasive mesh
- PL Siatka ścierna
- DE Schleifgitter
- RU Шлифовальная сетка
- CS Brusné pletivo
- RO Plasă abrazivă
- HU Csiszolóháló
- ES Red abrasiva nacional



No.	Grit / Ziarnistość	Size / Rozmiar [mm]	
07879	P40	105x280	50
07880	P60	105x280	50
07881	P80	105x280	50
07882	P100	105x280	50
07883	P120	105x280	50
07884	P150	105x280	50
07885	P180	105x280	50
07886	P220	105x280	50

- EN Abrasive sponge
- PL Kostka ścierna
- DE Schleifschwamm
- RU Губка для шлифования
- CS Hubka brusná
- RO Burete abraziv
- HU Dörzsszivacs
- ES Esponja abrasiva



No.	Grit / Ziarnistość	Size / Rozmiar [mm]	
08288	P60	68x100x25	100
08289	P80	68x100x25	100
08290	P100	68x100x25	100
08291	P120	68x100x25	100
08292	P150	68x100x25	100
08293	P180	68x100x25	100

- EN Abrasive sponge
- PL Kostka ścierna
- DE Schleifschwamm
- RU Губка для шлифования
- CS Hubka brusná
- RO Burete abraziv
- HU Dörzsszivacs
- ES Esponja abrasiva



No.	Grit / Ziarnistość	Size / Rozmiar [mm]	
08301	P60	125x90x65x25	100
08302	P80	125x90x65x25	100
08303	P100	125x90x65x25	100
08304	P120	125x90x65x25	100
08306	P150	125x90x65x25	100
08307	P180	125x90x65x25	100
08308	P220	125x90x65x25	100

EN Abrasive disc with velcro
 PL Krażek ścierny z rzepem
 DE Fiberschleifscheiben ungelocht
 RU Круг шлифовальный на липучке
 CS Brusný kotouč /zip/
 RO Disc abraziv (scai)
 HU Csiszoló tárcsa /tapadókoronggal/
 ES Juego de discos abrasivos /velcro/



No.	Grit / Ziamistość	Ø [mm]	pcs / szt.	
08553	P36	125	5	50/200
08554	P40	125	5	50/200
08556	P60	125	5	50/200
08558	P80	125	5	50/200
08560	P100	125	5	50/200
08562	P120	125	5	50/200
08565	P150	125	5	50/200

EN Abrasive sheets with holes
 PL Arkusze ścierny z otworami
 DE Schleifbogen gelocht
 RU Шлифовальная бумага перфорированная
 CS Brusné archy /z otvorami/
 RO Hartie abraziva cu orificii
 HU Csiszolóív /lyukakkal/
 ES Ojas abrasivas /con agujer/

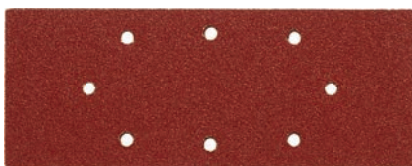

No.	Grit / Ziamistość	Size / Rozmiar [mm]	pcs / szt.	
08534	P40	93x240	5	50/200
08536	P60	93x240	5	50/200
08538	P80	93x240	5	50/200
08540	P100	93x240	5	50/200
08542	P120	93x240	5	50/200
08545	P150	93x240	5	50/200

EN Sanding block
 PL Blok ścierny
 DE Handschleifer
 RU Брусок для шлифования
 CS Brusný blok
 RO Suport smirghel
 HU Csiszolóblokk
 ES Bloque abrasivo



No.	Size / Rozmiar [mm]	
07970	210x100	20/80

EN Abrasive disc with holes with velcro
 PL Krażek ścierny z otworami
 DE Fiberschleifscheiben gelocht
 RU Круг шлифовальный перфорированный для липучки
 CS Brusný kotouč z otvorami
 RO Disc abraziv cu orificii
 HU Csiszoló tárcsa /tapadókoronggal/
 ES Juego de discos abrasivos con agujeros

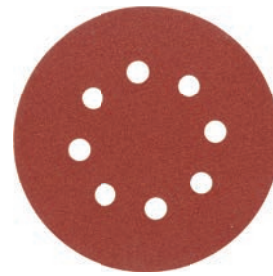

No.	Grit / Ziamistość	Ø [mm]	pcs / szt.	
08573	P36	125	5	50/200
08574	P40	125	5	50/200
08576	P60	125	5	50/200
08578	P80	125	5	50/200
08580	P100	125	5	50/200
08582	P120	125	5	50/200
08585	P150	125	5	50/200

EN Sanding block
 PL Blok ścierny
 DE Handschleifer
 RU Брусок для шлифования
 CS Brusný blok
 RO Suport smirghel
 HU Csiszolóblokk
 ES Bloque abrasivo



No.	Size / Rozmiar [mm]	
07950	160x85	20/100

EN Hand grinding block
 PL Blok ścierny z rzepem
 DE Schleifblock mit Klett
 RU Абразивный блок с липучкой
 CS Brusná kostka se suchým zipem
 RO Suport de slefuire manual
 HU Csiszolóblokk, tépózáras
 ES Bloque abrasivo con velcro



No.	Ø [mm]	
07955	125	10/60

EN Hand grinding block
 PL Blok ścierny z rzepem
 DE Schleifblock mit Klett
 RU Абразивный блок с липучкой
 CS Brusná kostka se suchým zipem
 RO Suport de slefuire manual
 HU Csiszolóblokk, tépőzáras
 ES Bloque abrasivo con velcro



No.	Ø [mm]	
07956	150	10/60

8

EN Sanding block
 PL Blok ścierny skręcany
 DE Handschleifer
 RU Тёрка для шлифования
 CS Brusný blok
 RO Suport smirghel
 HU Csiszolóblokk
 ES Bloque abrasivo



No.	Size / Rozmiar [mm]	
07960	220x100	30

EN Polishing set
 PL Zestaw polerski
 DE Polierset
 RU Полировальный набор

CS Čistící a leštící souprava
 PL Set pt. lustruit
 HU Tisztító és polírozó készlet
 ES Conjunto de limpieza e polimento



No.		
25420		30/60

EN Hand grinding block
 PL Blok ścierny z rzepem
 DE Schleifblock mit Klett
 RU Абразивный блок с липучкой
 CS Brusná kostka se suchým zipem
 RO Suport de slefuire manual
 HU Csiszolóblokk, tépőzáras
 ES Bloque abrasivo con velcro



No.	Ø [mm]	
07957	150	10/120

EN Sanding block
 PL Blok ścierny zatrask
 DE Handschleifer
 RU Тёрка для шлифования
 CS Brusný blok
 RO Suport smirghel
 HU Csiszolóblokk
 ES Bloque abrasivo



No.	Size / Rozmiar [mm]	
07962	210x100	30

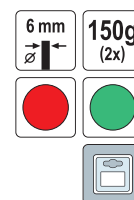
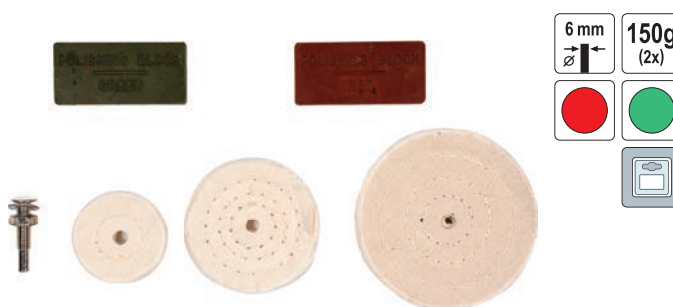

Memo

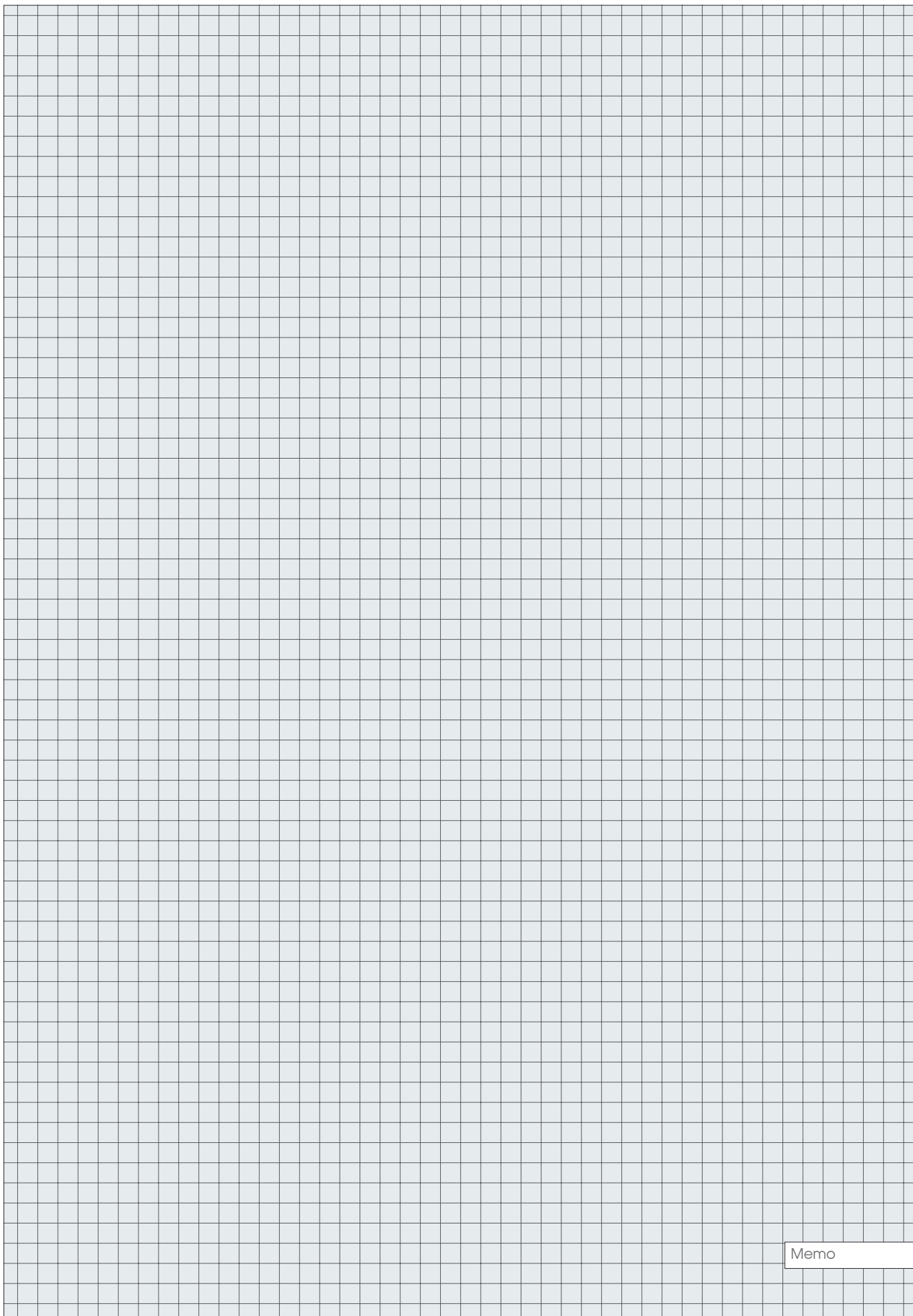

Memo



9

Plumbing tools Narzędzia hydrauliczne



Ratchet die stocks
Komplety gwintownic ręcznych

124

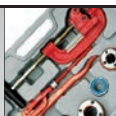

Hinged pipe vices
Imadła zaciskowe do rur

124

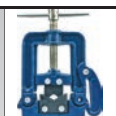

Water pump pliers
Szczypce nastawne

124



Pipe wrenches
Klucze do rur

124-125



Pipe wrenches Stillson type
Klucze do rur typu Stillson.....

124

Adjustable pipe wrenches
Klucze do rur nastawne.....

125

Adjustable wrenches
Klucze nastawne francuskie.....

125

Chain pipe wrenches
Klucze do rur łańcuchowe

125



Pipe cutters
Obcinaki do rur

126



Calibrators
Kalibratory

126



Pipe welders
Zgrzewarki do rur

126-127



Burners & soldering tools
Palniki i lutownice

127-128



Hydraulic accessories
Akcesoria hydrauliczne

128-129



9

- EN Ratchet die stock
- PL Zestaw gwintownic
- DE Schneidkluppensatz
- RU Набор резьбоварезной сантехнический
- CS Sada závitníků
- RO Set de filiere
- HU Menetfűrő készlet
- ES Juego de roscar



No.	Size / Rozmiar	pcs / szt.	
55820	3/8" (10.0 mm), 1/2" (12.5 mm), 3/4" (19.0 mm), 1" (25.0 mm), 1-1/4" (32.0 mm)	7	4

9

- EN Hinged pipe vice
- PL Imadło zaciskowe do rur
- DE Rohrschraubstock
- RU Тиски для труб
- CS Upínací svěrák na trubky
- RO Menghină pt. țevi
- HU Satu, csőszorító
- ES Tornillo de apriete para tubos

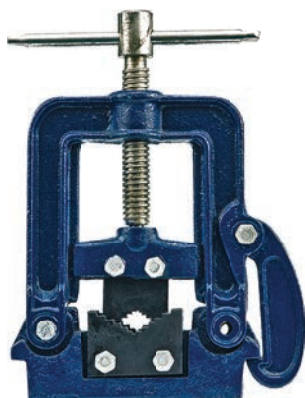

No.	Mounting element diameter / Średnica mocowanego elementu [mm]	
36570	13-50	6

- EN Pipe wrench
- PL Klucz do rur
- DE Rohrschlüssel
- RU Ключ трубный
- CS Klič součásti na trubky
- RO Chei pt. țevi
- HU Csőkulcs
- ES Llave de fontanero



No.	L [mm]	
55250	250	6/48
55300	300	6/36
55350	350	6/24

- EN Ratchet die stock
- PL Zestaw gwintownic
- DE Schneidkluppensatz
- RU Набор резьбоварезной сантехнический
- CS Sada závitníků
- RO Set de filiere
- HU Menetfűrő készlet
- ES Juego de roscar



No.	Size / Rozmiar	pcs / szt.	
55830	1-1/2" (38.0 mm), 2" (50.0 mm)	6	2

- EN Water pump pliers
- PL Szczypce hydrauliczne nastawne
- DE Wasserpumpenzange
- RU Клещи переставные
- CS Keleště siko
- RO Clește papagal
- HU Vízpumpafagó
- ES Alicates de fontanero ajustables



No.	L [mm]	
41510	250	10/50

- EN Pipe wrench
- PL Klucz do rur
- DE Rohrschlüssel
- RU Ключ трубный
- CS Klič součásti na trubky
- RO Chei pt. țevi
- HU Csőkulcs
- ES Llave de fontanero



No.	L [mm]	
55620	195	6/36
55625	245	6/30
55630	275	6/24
55635	310	6/18
55645	395	4/12
55660	490	2/6
55690	750	2/4

EN Adjustable pipe wrench
 PL Klucz nastawny do rur
 DE Rohrschlüssel
 RU Ключ трубный

CS Nastavitelný klíč na trubky
 RO Cheie reglabilă pt. țevi
 HU Állítható csőkulcs
 ES Llave de vaso para tubería



No.	Max. pipe diameter / Maks. średnica rury	L [mm]	
55100	1" (25 mm)	330	12/36
55150	1-1/2" (38 mm)	390	10/20
55200	2" (50 mm)	540	6/12

EN Adjustable pipe wrench
 PL Klucz nastawny do rur
 DE Rohrschlüssel
 RU Ключ трубный

CS Nastavitelný klíč na trubky
 RO Cheie reglabilă pt. țevi
 HU Állítható csőkulcs
 ES Llave de vaso para tubería



VOREL

No.	Max. pipe diameter / Maks. średnica rury	L [mm]	
55215	1" (25 mm)	310	24
55216	1-1/2" (38 mm)	420	1/16
55217	2" (50 mm)	560	1/8

EN Adjustable wrench
 PL Klucz nastawny francuski
 DE Stahlschraubenschlüssel / Franzose/
 RU Ключ разводной

CS Nastavitelný klíč francouz
 RO Cheie reglabilă franceză
 HU Állítható franciakuks
 ES Llave ajustable inglesa



VOREL

No.	Jaws opening capacity / Zakres rozwarcia szczęk [mm]	Jaws width / Szerokość szczęk [mm]	
54497	0-25	60	10
54498	0-35	70	10
54499	0-45	80	10
54500	0-55	90	5
54510	0-65	100	5

EN Adjustable pipe wrench
 PL Klucz nastawny do rur
 DE Rohrschlüssel
 RU Ключ трубный
 CS Nastavitelný klíč na trubky
 RO Cheie reglabilă pt. țevi
 HU Állítható csőkulcs
 ES Llave de vaso para tubería



VOREL

No.	Max. pipe diameter / Maks. średnica rury	L [mm]	
55210	1" (25 mm)	320	1/24
55211	1-1/2" (38 mm)	425	1/16
55212	2" (50 mm)	560	1/8

EN Adjustable pipe wrench
 PL Klucz nastawny do rur
 DE Rohrschlüssel
 RU Ключ трубный

CS Nastavitelný klíč na trubky
 RO Cheie reglabilă pt. țevi
 HU Állítható csőkulcs
 ES Llave de vaso para tubería



VOREL

No.	Max. pipe diameter / Maks. średnica rury	L [mm]	
55220	1" (25 mm)	315	1/24
55221	1-1/2" (38 mm)	425	1/16
55222	2" (50 mm)	560	1/8

EN Chain pipe wrench
 PL Klucz łańcuchowy do rur
 DE Kettenrohrzange
 RU Ключ цепной для труб
 CS Klíč řetězový na trubky
 RO Cheie reglabilă pt. țevi cu lanț
 HU Láncos csőfogó
 ES Llave de cadena



VOREL

No.	Max. cutting diameter / Maks. średnica cięcia	L [mm]	
55792	4" (100.0 mm)	300	10/30

EN Pipe cutter
 PL Obcinak do rur
 DE Rohrabschneider
 RU Труборез для труб
 CS Rezač trubek
 RO Clește pt. tăiat țevi
 HU Csővágó olló csövekhez
 ES Cortatubos



No.	Cutting diameter / Średnica cięcia	
78381	1/10" - 1-1/4" (3-32 mm)	60

9

EN Plastic pipe edging tool
 PL Gratownik do rur
 DE Aussen- und Innenentgraten Werkzeug
 RU Гратосниматель
 CS Odhrotač trubek
 RO Dispozitiv pt. sanfren țevi
 HU Locsolótömlő csatlakozó
 ES Escariador bilateral de tubos



No.	Cutting diameter / Średnica cięcia [mm]	
78385	6-36	25/50

EN Pipe calibration tool
 PL Kalibrator do rur
 DE Kalibrierer für Mehrschichtverbundrohr
 RU Калибратор пластиковый

CS Kalibrátor na trubky
 RO Calibrator teava multistrat
 HU Ótrétegű cső kalibráló
 ES Calibrador para tubos multicapa

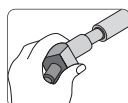

10 mm	14 mm
12 mm	16 mm
14 mm	18 mm
16 mm	20 mm
20 mm	25-26 mm
26 mm	32 mm



No.		
55740		300

EN Universal quick deburrer
 PL Gratownik
 DE Universal-Schnell-Entgrater
 RU Универсальный быстро гратосниматель
 CS Univerzální odhrotač
 RO Debavurator rapid universal
 HU Univerzális gyors sorjátlanító
 ES Desbarbador rápida universal

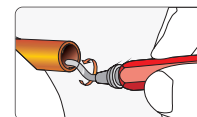
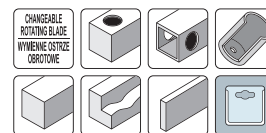

No.		
78388		50/150

EN PVC pipe cutter
 PL Obcinak do rur PVC
 DE PVC Rohrabschneider
 RU Труборез для труб из ПВХ
 CS Rezač PVC trubek
 RO Clește pt. tăiat țevi din PVC
 HU Csővágó olló PVC csövekhez
 ES Cortatubos para PVC

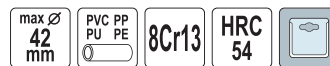

No.	Max. cutting diameter / Maks. średnica cięcia [mm]	
78341	42	12/48

EN PVC plastic pipe welder
 PL Zgrzewarka do rur termoplastycznych
 DE Schweissgerät für thermoplastische Rohre
 RU Аппарат для сварки пластиковых труб
 CS Svářečka na termoplastické trubky
 RO Masina de sudat țevi termoplastice
 HU Hegesztő berendezés termoplasztikus csövekhez
 ES Máquina de soldar las tubos termoplásticos

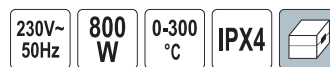

No.	Power / Moc [W]	
78911	800	5

EN PVC plastic pipe welder
 PL Zgrzewarka do rur termoplastycznych
 DE Schweissgerät für thermoplastische Rohre
 RU Аппарат для сварки пластиковых труб
 CS Svářečka na termoplastické trubky
 RO Masina de sudat tevi termoplastice
 HU Hegesztő berendezés termoplasztikus csövekhez
 ES Máquina de soldar las tubos termoplásticos

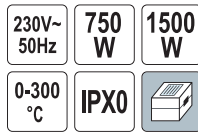

No.	Power / Moc [W]	Box icon
78912	750, 1500	4

EN Gas torch
 PL Palnik gazowy
 DE Gasbrenner
 RU Газовая горелка
 CS Plynový hořák
 RO Arzător de gaz
 HU Gázégő
 ES Soplete de gas



No.	Power / Moc [kW]	Box icon
73420	0.22	10/60

EN Gas blow torch
 PL Palnik gazowy
 DE Lötbrenner
 RU Газовая горелка
 CS Plynový hořák
 RO Arzător de gaz
 HU Gázégő
 ES Soplete de gas



No.	Power / Moc [kW]	Box icon
73412	1.3	10/60

EN PVC plastic pipe welder
 PL Zgrzewarka do rur termoplastycznych
 DE Schweissgerät für thermoplastische Rohre
 RU Аппарат для сварки пластиковых труб
 CS Svářečka na termoplastické trubky
 RO Masina de sudat tevi termoplastice
 HU Hegesztő berendezés termoplasztikus csövekhez
 ES Máquina de soldar las tubos termoplásticos

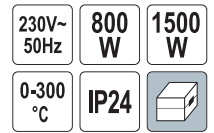

No.	Power / Moc [W]	Box icon
78910	800, 1500	5

EN Soldering tool 3 in 1
 PL Lutownica gazowa 3 w 1
 DE 3 in 1 Gaslötkolben
 RU Газовый паяльник 3 в 1
 CS Plynová rajka 3 v 1
 RO Ciocan de lipit cu gaz 3 in 1
 HU Gaz-forrasztópakka 3 az 1
 ES Soldador de gas 3 en 1

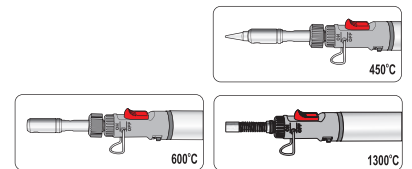

No.	Power / Moc [W]	Box icon
73410	25-80	12/48

EN Gas blow torch
 PL Palnik gazowy
 DE Lötbrenner
 RU Газовая горелка
 CS Plynový hořák
 RO Arzător de gaz
 HU Gázégő
 ES Soplete de gas



No.	Power / Moc [kW]	Box icon
73413	1.3	10/60

- EN Gas soldering lamp
- PL Gazowa lampa lutownicza
- DE Gaslötlampe
- RU Газовая паяльная лампа
- CS Plynová pájecí lampka
- RO Lampă de lipit pe gaz
- HU Gázos forrasztólámpa
- ES Lampa de gas para soldar

1.7 kW	max °C 1200	123 g/h	BUTANE BUTAN
COMPOSITE BODY KOMPÓZITÓVY KORPUS		190 g	



No.	Power / Moc [kW]	
73400	1.7	12

- EN Gas soldering lamp
- PL Gazowa lampa lutownicza
- DE Gaslötlampe
- RU Газовая паяльная лампа
- CS Plynová pájecí lampka
- RO Lampă de lipit pe gaz
- HU Gázos forrasztólámpa
- ES Lampa de gas para soldar

1.7 kW	PIEZO	max °C 850	123 g/h
GAS GAZ	BUTANE BUTAN	METAL BODY METALOVY KORPUS	190 g



No.	Power / Moc [kW]	
73404	1.7	20

- EN PTFE tape
- PL Taśma PTFE
- DE Teflonband
- RU Фумлента
- CS Teflonová páska
- RO Bandă de teflon
- HU Teflon szalag
- ES Cinta de teflón

PTFE	
------	--



No.	W [mm]	Thickness / Grubość [mm]	L [m]	
75201	12	0.1	12	250/1000
75202	19	0.2	15	200

- EN Thread sealing paste
- PL Pasta uszczelniająca do gwintów
- DE Paste zum Abdichten der Gewinde
- RU Паста для герметизации резьбы
- CS Těsnící pasta na závity
- RO Pastă etanșantă pt. filet
- HU Menettömítő paszta
- ES Pasta selladora para roscas

--



No.	m [g]	
86750	65	48
86751	250	24

- EN Gas soldering lamp
- PL Gazowa lampa lutownicza
- DE Gaslötlampe
- RU Газовая паяльная лампа
- CS Plynová pájecí lampka
- RO Lampă de lipit pe gaz
- HU Gázos forrasztólámpa
- ES Lampa de gas para soldar

1.7 kW	PIEZO	max °C 1200	123 g/h
BUTANE BUTAN	METAL BODY METALOVY KORPUS	190 g	



No.	Power / Moc [kW]	
73403	1.7	12

- EN PTFE tape
- PL Taśma PTFE
- DE Teflonband
- RU Фумлента
- CS Teflonová páska
- RO Bandă de teflon
- HU Teflon szalag
- ES Cinta de teflón

PTFE	
------	--



No.	W [mm]	Thickness / Grubość [mm]	L [m]	
75200	12	0.075	10	12/2400

- EN Thread sealing paste
- PL Pasta uszczelniająca do gwintów
- DE Paste zum Abdichten der Gewinde
- RU Паста для герметизации резьбы
- CS Těsnící pasta na závity
- RO Pastă etanșantă pt. filet
- HU Menettömítő paszta
- ES Pasta selladora para roscas

--



No.	m [g]	
86752	360	24

- EN Hydraulic repair kit
- PL Hydrauliczny zestaw naprawczy
- DE Hydraulischer Reparatursatz
- RU Комплект для уплотнения резьбы
- CS Hydraulická opravárenská souprava
- RO Set de reparatii pt. instalatori
- HU Vízvezeték javító készlet
- ES Juego para reparaciones hidráulicas

--



No.	m [g]	
86761	100, 65	40

- EN Oakum
- PL Pakuły lniane
- DE Leinenwerg
- RU Лен сантехнический
- CS Lněná koudel
- RO Călți de in
- HU Len kóc
- ES Estopa de lino



No.	m [g]	
86760	100	50

- EN Drain cleaner
- PL Pistolet do udrażniania rur
- DE Pistole zum Reinigen von Röhren
- RU Пневматический пистолет для прочистки труб
- CS Pistole na čištění trubek
- RO Pistol pt. curățarea țevilor
- HU Csőtisztító pisztoly
- ES Pistola desatacaños



No.	Ø [mm]	
55500	63, 135	10

- EN Drain auger
- PL Spirala kanalizacyjna
- DE Hand-Rohrreinigungsspirale
- RU Трос сантехнический для чистки труб
- CS Spirála kanalizační
- RO Dispozitiv de desfundat scurgere
- HU Csőtisztító spirál
- ES Desatacadador espiral

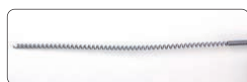

No.	Ø [mm]	L [m]	
55541	5	1.5	20/80
55542	6	3.0	18/36

- EN Lubricant for PVC pipes
- PL Pasta poślizgowa do rur PCV
- DE Gleitpaste für PVC-Röhre
- RU Силиконовая смазка для ПВХ труб
- CS Kluzná pasta na PVC trubky
- RO Pastă glisantă pt. țevi PVC
- HU Sikosító paszta PVC csövekhez
- ES Pasta de deslizamiento para tubos de PCV



No.	m [g]	
86770	250	18
86771	500	15

- EN Drain suction pump
- PL Pompa do udrażniania kanalizacji
- DE Hochdruck-Rohrreiner
- RU Пневматический вантуз для прочистки труб
- CS Čerpadlo na čištění trubek
- RO Pompă pt. curățarea țevilor
- HU Csőtisztító szivattyú
- ES El desagüe del fregadero limpiador



No.	Ø [mm]	
55505	65, 155	24

- EN Drain auger
- PL Spirala kanalizacyjna
- DE Hand-Rohrreinigungsspirale
- RU Трос сантехнический для чистки труб
- CS Spirála kanalizační
- RO Dispozitiv de desfundat scurgere
- HU Csőtisztító spirál
- ES Desatacadador espiral



No.	Ø [mm]	L [m]	
55544	9	5	5/10
55545	9	10	4/8

10

Fastening tools Narzędzia do łączenia



Hand riveters Nitownice ręczne

132-133



Hand riveters
Nitownice ręczne..... 132

Hand riveting tool
Nitownice ręczne, dźwigniowe..... 133

Rivets Nity

133



Aluminium blind rivets
Nity aluminiowe..... 133

Pneumatic riveters Nitownice pneumatyczne

134

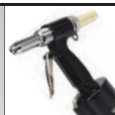

Profile connection pliers Szczypce do łączenia profili

134



Staple guns, staples & nails Zszywacze, zszywki i gwoździe

134-136



Staple guns
Zszywacze..... 134

Staple removers
Rozszywacze..... 135

Staples
Zszywki..... 135

Brad nails
Szyty..... 136

Nails
Gwoździe..... 136

Screw, plug & hook sets Zestawy wkrętów, kołków i haków

136-137



Caulking guns Wyciskacze do mas

138-139



Foam guns Pistolety do pianki montażowej

139-140



Hose clips Opaski ślimakowe

140-141



Screw clamps Obejmy śrubowe

141



Cable ties Opaski plastikowe

141



Hook & loop cable ties Opaski z rzepem

142



Glue sticks & glue applicators Wkłady klejowe i dozowniki do kleju

142



Packing tape dispensers Podajniki taśmy pakowej

142



Tapes Taśmy

142-145



Ropes & lines Sznury i linki

145-147



EN Hand riveter
 PL Nitownica ręczna
 DE Hand-Nietzange
 RU Ручной заклепочник
 CS Ruční nýtovačka
 RO Presă de nituit manuală
 HU Kézi popszegecshúzó
 ES Remachadora de mano



No.	L [mm]	Ø [mm]	
70000	250	2,4, 3,2, 4, 4,8	12/24

EN Hand riveter
 PL Nitownica ręczna
 DE Hand-Nietzange
 RU Ручной заклепочник
 CS Ruční nýtovačka
 RO Presă de nituit manuală
 HU Kézi popszegecshúzó
 ES Remachadora de mano



No.	L [mm]	Ø [mm]	
70023	250	2,4, 3,2, 4, 4,8	12/24

EN Hand riveter
 PL Nitownica ręczna
 DE Hand-Nietzange
 RU Ручной заклепочник
 CS Ruční nýtovačka
 RO Presă de nituit manuală
 HU Kézi popszegecshúzó
 ES Remachadora de mano

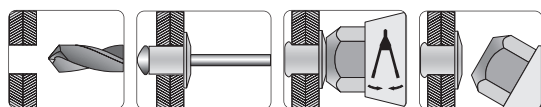
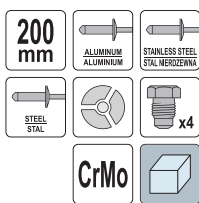

No.	L [mm]	Ø [mm]	
70035	200	2,4, 3,2, 4, 4,8	30

EN Hand riveter
 PL Nitownica ręczna
 DE Hand-Nietzange
 RU Ручной заклепочник
 CS Ruční nýtovačka
 RO Presă de nituit manuală
 HU Kézi popszegecshúzó
 ES Remachadora de mano



No.	L [mm]	Ø [mm]	
70020	240	2,4, 3,2, 4, 4,8	12/24

EN Hand riveter
 PL Nitownica ręczna
 DE Hand-Nietzange
 RU Ручной заклепочник
 CS Ruční nýtovačka
 RO Presă de nituit manuală
 HU Kézi popszegecshúzó
 ES Remachadora de mano



No.	L [mm]	Ø [mm]	
70030	230	2,4, 3,2, 4, 4,8	15/30

EN Hand riveter
 PL Nitownica ręczna
 DE Hand-Nietzange
 RU Ручной заклепочник
 CS Ruční nýtovačka
 RO Presă de nituit manuală
 HU Kézi popszegecshúzó
 ES Remachadora de mano

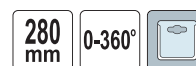

No.	L [mm]	Ø [mm]	
70100	280	2,4, 3,2, 4, 4,8	6/24

EN Hand riveter
 PL Nitownica ręczna
 DE Hand-Nietzange
 RU Ручной заклепочник
 CS Ruční nýtovačka
 RO Presă de nituit manuală
 HU Kézi pöpszegecsűző
 ES Remachadora de mano



VOREL

No.	L [mm]	Ø [mm]	
70160	250	2,4, 3,2, 4, 4,8	12/24

EN Hand riveting tool
 PL Nitownica dźwigniowa
 DE Blindnietzange
 RU Заклепочник рычажный
 CS Nýtovačka páková
 RO Nituire pârghie
 HU Pöpszegecsűző
 ES Remachadora de palanca

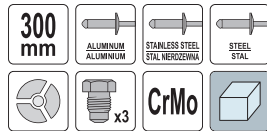

VOREL

No.	L [mm]	Ø [mm]	
70201	300	3,2, 4, 4,8	20

EN Hand riveting tool
 PL Nitownica dźwigniowa
 DE Blindnietzange
 RU Заклепочник рычажный
 CS Nýtovačka páková
 RO Nituire pârghie
 HU Pöpszegecsűző
 ES Remachadora de palanca



VOREL

No.	L [mm]	Ø [mm]	
70210	400	3,4, 4, 4,8	10/20

EN Hand nut tool
 PL Nitownica ręczna do nitonakrętek
 DE Nietmutterzange
 RU Ручной заклепочник для резьбовых заклепок

CS Nýtovací kleště na maticu
 RO Clește pt. piulițe nituibile
 HU Emeltyűs pöpszegecsűző
 ES Remachadora de tuercas



VOREL

No.	L [mm]	Nuts diameter / Średnica nitonakrętek	
70270	265	M3, M4, M5, M6	5/20

EN Hand riveter
 PL Nitownica ręczna
 DE Hand-Nietzange
 RU Ручной заклепочник

CS Ruční nýtovačka
 RO Presă de nituit manuală
 HU Kézi pöpszegecsűző
 ES Remachadora de mano

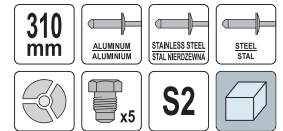

VOREL

No.	L [mm]	Ø [mm]	
70202	310	2,4, 3,2, 4, 4,8, 6,4	16

EN Aluminium blind rivets
 PL Nity aluminiowe
 DE Aluminiumblindnieten
 RU Заклёпки алюминиевые

CS Hliníkové nýty
 RO Nituri din aluminiu
 HU Alu pöpszegecs
 ES Remaches de aluminio



VOREL

No.	L [mm]	Ø [mm]	pcs / szt.	
70320	6.4	3.2	50	150/300
70330	9.6	3.2	50	150/300
70340	12.7	3.2	50	150/300
70400	6.4	4.0	50	100/200
70410	9.6	4.0	50	100/200
70420	12.7	4.0	50	100/200
70430	19.0	4.0	50	100/200
70480	6.4	4.8	50	100/200
70490	9.6	4.8	50	100/200
70500	12.7	4.8	50	100/200
70510	19.0	4.8	50	75/150

EN Pneumatic riveting machine
 PL Nitownica pneumatyczna
 DE Druckluft Nietzange
 RU Пневматический заклепочник
 CS Pneumatická nýtovačka
 RO Presa pneumatică pt. nituit
 HU Pneumatikus popszegecshúzó
 ES Máquina remachadora

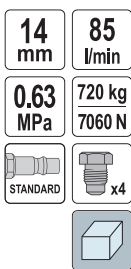

$L_{pa} = 76,1 \pm 3 \text{ dB}$; $L_{wa} = 87,1 \pm 3 \text{ dB}$; $a_b = 0,85 \pm 0,59 \text{ m/s}^2$

No.	Ø [mm]	Max. piston stroke / Maks. skok tłoka silownika [mm]	F [kg]	F [N]	Box
70280	2,4, 3,2, 4, 4,8	14	720	7060	10

EN Staple gun
 PL Zszywacz tapicerski
 DE Tacker
 RU Стенлеп
 CS Čalounická sešivačka
 RO Capsator tapiterie
 HU Kárpitos tűzőgép
 ES Grapadora de tapicero



No.	Staple length / Długość zszywki [mm]	Box
71000	4-8	10/60

EN Staple gun
 PL Zszywacz tapicerski
 DE Tacker
 RU Стенлеп
 CS Čalounická sešivačka
 RO Capsator tapiterie
 HU Kárpitos tűzőgép
 ES Grapadora de tapicero

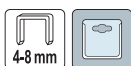

No.	Staple length / Długość zszywki [mm]	Box
71040	4-8	10/40

EN Profile connection pliers
 PL Szczypce do łączenia profili
 DE Profil Verbundzange
 RU Клещи для соединения профилей
 CS Kleště do spojování profilů
 RO Cleste sertizat profile rigips
 HU Profilösszekítő fogó
 ES Alicates para unir perfiles



No.	L [mm]	Box
04300	280	6/36

EN Profile connection pliers
 PL Szczypce do łączenia profili
 DE Profil Verbundzange
 RU Клещи для соединения профилей
 CS Kleště do spojování profilů
 RO Cleste sertizat profile rigips
 HU Profilösszekítő fogó
 ES Alicates para unir perfiles



No.	L [mm]	Box
04301	300	6/24

EN Staple gun
 PL Zszywacz tapicerski
 DE Tacker
 RU Стенлеп
 CS Čalounická sešivačka
 RO Capsator tapiterie
 HU Kárpitos tűzőgép
 ES Grapadora de tapicero

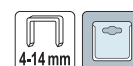

No.	Staple length / Długość zszywki [mm]	Box
71050	4-8	10/40

EN Staple gun
 PL Zszywacz tapicerski
 DE Tacker
 RU Стенлеп
 CS Čalounická sešivačka
 RO Capsator tapiterie
 HU Kárpitos tűzőgép
 ES Grapadora de tapicero

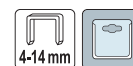

No.	Staple length / Długość zszywki [mm]	Box
71052	4-14	10/20

EN Staple gun
 PL Zszywacz tapicerski
 DE Tacker
 RU Стенпел
 CS Čalounická sešíváčka
 RO Capsator tapiterie
 HU Kárpitos tűzőgép
 ES Grapadora de tapicero

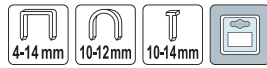

VOREL

No.		
71060		6/24

EN Staple remover
 PL Rozszywacz
 DE Entkammerer
 RU Расшиватель
 CS Rozsešíváč
 RO Extractor capse
 HU Kapocskiszedo
 ES Quitagrapas

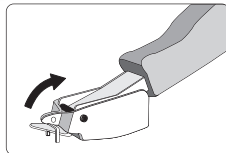

VOREL

No.		
71160		10/40

EN Staples type „E” for mesh pliers
 PL Zszywki typu „E” do mocowania siatki
 DE Zaurringe
 RU Скобы для обжима сетки
 CS Sponky
 RO Capse pt. făcut cuști
 HU Kapcsok madárháló rögzítéséhez
 ES Grapas omega



VOREL

No.	For / Dla	
49841	49840	10/60

EN Hammer tacker
 PL Zszywacz młotkowy
 DE Hammer Tacker
 RU Молотковый степлер
 CS Sponkovač kladivový
 RO Capsator ciocan
 HU Kalapács tűzőgép
 ES Grapadora de martillo

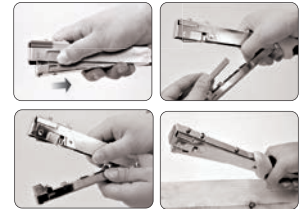
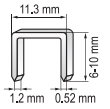
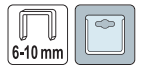

VOREL

No.	Staple length / Długość zszywki [mm]	
71080	6-10	6/24

EN Mesh pliers
 PL Szczypce do mocowania siatki ogrodzeniowej
 DE Zaunklammerzange
 RU Стенпел-сшиватель для металлической сетки и сетки-рабицы
 CS Kleště pro spojování a montáž pletiv
 RO Clește de capsat pt. fixarea gardurilor
 HU Fogó kerítéskapocshoz
 ES Hog anillo alicates



VOREL

No.		
49840		50

EN Staples
 PL Zszywki
 DE Heftklammern
 RU Скобы
 CS Sešívky
 RO Capse tapiterie
 HU Tűzőkapocs
 ES Grapas

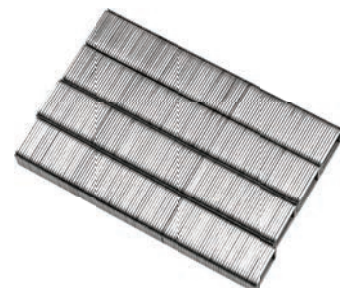

VOREL

No.	Staple length / Długość zszywki [mm]	Staple thickness / Grubość zszywki [mm]	Staple width / Szerokość zszywki [mm]	pcs / szt.	
72040	4	0.7	11.3	1000	60/480
72060	6	0.7	11.3	1000	60/360
72080	8	0.7	11.3	1000	60/300
72100	10	0.7	11.3	1000	60/240
72120	12	0.7	11.3	1000	50/200
72140	14	0.7	11.3	1000	40/160

EN Staples
 PL Zszywki
 DE Heftklammern
 RU Скобы
 CS Sešivky
 RO Capse tapiterie
 HU Tűzőkapocs
 ES Staples



VOREL

No.	Staple length / Długość zszywki [mm]	Staple thickness / Grubość zszywki [mm]	Staple width / Szerokość zszywki [mm]	pcs / szt.	
71970	6	0.9	12.7	12000	10
71971	10	0.9	12.7	7500	10
71972	16	0.9	12.7	4500	10

EN Staples
 PL Zszywki
 DE Heftklammern
 RU Скобы
 CS Sešivky
 RO Capse tapiterie
 HU Tűzőkapocs
 ES Staples

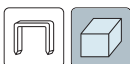

VOREL

No.	Staple length / Długość zszywki [mm]	Staple thickness / Grubość zszywki [mm]	Staple width / Szerokość zszywki [mm]	pcs / szt.	
71975	16	1.2	5.5	2000	27
71976	21	1.2	5.5	2200	18
71977	25	1.2	5.5	2000	18
71978	38	1.2	5.5	1600	15

EN Coil nails
 PL Gwoździe papowe bębnowe
 DE Spulennägel
 RU Гвозди барабанные для пневмопистолета
 CS Hřebíky spojené drátem
 RO Cuie in rola
 HU Dobtáras szeg
 ES Coil nails



VOREL

No.	Nail length / Długość gwoździa [mm]	Nail diameter / Średnica gwoździa [mm]	pcs / szt.	
72000	19	3.1	4200	1
72001	22	3.1	4200	1

EN Nails on paper tape
 PL Gwoździe taśmowe
 DE Streifennägel
 RU Гвозди отделочные для пневмопистолета
 CS Hřebík nastřelovací
 RO Cuie
 HU Siktáras szeg
 ES Nails on paper tape



VOREL

No.	Nail length / Długość gwoździa [mm]	Nail diameter / Średnica gwoździa [mm]	pcs / szt.	
72010	50	2.8	3000	1
72011	65	2.8	3000	1
72012	75	2.8	3000	1
72013	90	3.1	2000	1

EN Brad nails
 PL Sztyfty
 DE Stauchkorfnägel
 RU Шпилька для степлера
 CS Kolářské hřebíky
 RO Cuie fara cap
 HU Műanyag spakli
 ES Brad nails



VOREL

No.	Staple length / Długość zszywki [mm]	Staple thickness / Grubość zszywki [mm]	Staple width / Szerokość zszywki [mm]	pcs / szt.	
71980	16	1.3	1.8	5000	27
71981	30	1.3	1.8	5000	18
71982	35	1.3	1.8	5000	15
71983	50	1.3	1.8	5000	15

EN Coil nails
 PL Gwoździe bębnowe
 DE Spulennägel
 RU Гвозди барабанные для пневмопистолета
 CS Hřebíky spojené drátem
 RO Cuie in rola
 HU Dobtáras szeg
 ES Coil nails

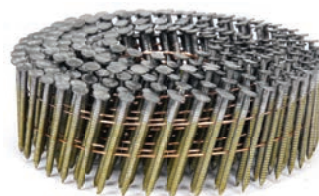

VOREL

No.	Nail length / Długość gwoździa [mm]	Nail diameter / Średnica gwoździa [mm]	pcs / szt.	
71990	32	2.1	7200	1
71991	38	2.1	7200	1
71992	50	2.1	5400	1
71993	64	2.5	3000	1
71994	70	2.5	3000	1
71995	75	2.5	3000	1
71996	80	2.8	3000	1
71997	90	2.8	3000	1

EN Screw & plug set
 PL Zestaw wkrętów i kółków rozporowych
 DE Dübel- und Schrauben Sortiment
 RU Набор крепежа шурупы и дюбеля
 CS Set šroubů a hmoždinek
 RO Set dibluri + holsuruburi
 HU Csavar és tipli készlet
 ES Juego de tornillos y pernos de expansión

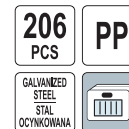

3 x 25 mm - 40 PCS, 3.5 x 35 mm - 25 PCS, 4 x 40 mm - 20 PCS, 5 x 40 mm - 15 PCS, 5 x 50 mm - 15 PCS, 6 x 60 mm - 8 PCS; 5 x 25 mm - 30 PCS, 6 x 30 mm - 20 PCS, 7 x 35 mm - 15 PCS, 8 x 40 mm - 10 PCS, 10 x 50 mm - 8 PCS

VOREL

No.	pcs / szt.	
24113	206	6/24

EN Screw & plug set
 PL Zestaw wkrętów i kołków rozporowych
 DE Dübel- und Schrauben Sortiment
 RU Набор крепежа шурупы и дюбеля
 CS Set šroubů a hmoždinek
 RO Set dibluri + holsuruburi
 HU Csavar és tiplí készlet
 ES Juego de tornillos y pernos de expansión

290 PCS PE GALVANIZED STEEL STAL OCYNKOWANA



3.5 x 30 mm - 35 PCS, 4 x 40 mm - 35 PCS, 4.5 x 50 mm - 30 PCS; 2.8 x 30 mm - 35 PCS, 3.0 x 40 mm - 40 PCS, 3.8 x 50 mm - 35 PCS; 5 x 30 mm - 30 PCS, 6 x 35 mm - 30 PCS, 8 x 50 mm - 20 PCS



No.	pcs / szt.	Icon
24112	290	5/20

EN Screw assortment
 PL Zestaw wkrętów
 DE Spanplattenschrauben Sortiment
 RU Набор винтов
 CS Šrouby
 RO Set holsuruburi
 HU Csavar készlet
 ES Juego de tornillos

370 PCS GALVANIZED STEEL STAL OCYNKOWANA



3 x 20 mm - 60 PCS, 3 x 25 mm - 50 PCS, 3.5 x 25 mm - 40 PCS, 3.5 x 30 mm - 35 PCS, 3.5 x 35 mm - 30 PCS, 4 x 20 mm - 40 PCS, 4 x 25 mm - 35 PCS, 4 x 30 mm - 30 PCS, 4 x 35 mm - 20 PCS, 4 x 40 mm - 15 PCS, 5 x 80 mm - 15 PCS



No.	pcs / szt.	Icon
24120	370	6/24

EN Picture hook assortment
 PL Zestaw haków na obrazy
 DE Bilderhaken-Set
 RU Набор крючков для картин
 CS Sada háčků na obrazy
 RO Set cârlige rame
 HU Résztes képakasztó készlet
 ES Juego de ganchos para cuadros

121 PCS ABS STEEL BRASS PLATED STAL PLATEROWANA MOSIĄDZEM



No.	pcs / szt.	Icon
24130	121	6/60

EN Drill bit and plug set
 PL Komplet wiertel z kołkami rozporowymi
 DE Dübel- und Schrauben Sortiment
 RU Набор крепежа шурупы и дюбеля
 CS Set šroubů a hmoždinek
 RO Set dibluri + holsuruburi
 HU Csavar és tiplí készlet
 ES Juego de brocas con pernos de expansión

300 PCS 1/4" 6.3 mm
 - +
 WOOD DRIVING
 BRUKK CEGLA CrV
 HSS 4241 PP



Ø 2, 3, 4, 5, 6, 8, 10 mm; HSS 4241; Ø 4, 5, 6, 8, 10 mm; Ø 4, 5, 6, 8, 10 mm; Ø 5 mm - 100 PCS, Ø 6 mm - 100 PCS, Ø 8 mm - 50 PCS, Ø 10 mm; - 25 PCS; PP; 1/4" (6.3 mm): 4.5, 6 mm (L=25mm); CrV; 1/4" (6.3 mm): PH1, PH2 mm (L=25mm); CrV; 1/4" (6.3 mm): PZ1, PZ2 (L=25mm); CrV; 1/4" (6.3 mm): (L=60mm); 1/4" (6.3 mm): (L=12 mm)



No.	pcs / szt.	Icon
24100	300	20

EN Screw assortment
 PL Zestaw wkrętów
 DE Spanplattenschrauben Sortiment
 RU Набор винтов
 CS Šrouby
 RO Set holsuruburi
 HU Csavar készlet
 ES Juego de tornillos

580 PCS CARBON STEEL STAL WĘGLOWA



4 x 20 mm - 50 PCS; 5 x 30 mm - 15 PCS; 3.5 x 19 mm - 50 PCS, 4.2 x 25 mm - 30 PCS; 1.5 x 25 mm - 120 PCS, 2.0 x 40 mm - 50 PCS, 3.0 x 60 mm - 25 PCS; M4 x 20 mm - 25 PCS, M5 x 25 - 15 PCS; M4 - 25 PCS, M5 - 15 PCS; M4 - 50 PCS, M5 - 30 PCS; M4 - 25 PCS, M5 - 15 PCS



No.	pcs / szt.	Icon
24122	580	6/24

EN Cable manager set
 PL Zestaw do mocowań kabli
 DE Kabelhalter-Set
 RU Набор для крепления проводов
 CS Sada na uspořádání kabelů
 RO Set organizare cabluri
 HU Kábelkezelő készlet
 ES Juego de elementos de fijación de cables

124 PCS



No.	pcs / szt.	Icon
24140	124	6/60

EN Caulking gun
 PL Wyciskacz do mas
 DE Kartuschenpistole
 RU Пистолет для герметика

CS Ruční výtlačná pistole
 RO Pistol silicon
 HU Masszakinyomó
 ES Pistola para masilla

230 mm

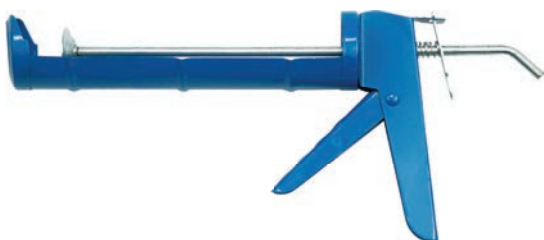

No.	Tube length / Długość tuby [mm]	
09100	230	20/40

EN Caulking gun
 PL Wyciskacz do mas
 DE Kartuschenpistole
 RU Пистолет для герметика

CS Ruční výtlačná pistole
 RO Pistol silicon
 HU Masszakinyomó
 ES Pistola para masilla

230 mm



No.	Tube length / Długość tuby [mm]	
09150	230	20/40

EN Caulking gun
 PL Wyciskacz do mas
 DE Kartuschenpistole
 RU Пистолет для герметика

CS Ruční výtlačná pistole
 RO Pistol silicon
 HU Masszakinyomó
 ES Pistola para masilla

230 mm



No.	Tube length / Długość tuby [mm]	
09160	230	6/12

EN Caulking gun
 PL Wyciskacz do mas
 DE Kartuschenpistole
 RU Пистолет для герметика

CS Ruční výtlačná pistole
 RO Pistol silicon
 HU Masszakinyomó
 ES Pistola para masilla

230 mm



No.	Tube length / Długość tuby [mm]	
09130	230	10/20

EN Caulking gun
 PL Wyciskacz do mas
 DE Kartuschenpistole
 RU Пистолет для герметика

CS Ruční výtlačná pistole
 RO Pistol silicon
 HU Masszakinyomó
 ES Pistola para masilla



No.	Tube length / Długość tuby [mm]	
09120	245	24

EN Building and construction cement grouting gun
 PL Aplikator do zapraw, mas szpachlowych i fugowania
 DE Spritze für Mörtel-, Spachtel- und Fugenmaßen
 RU Аппликатор для строительных растворов, шпатлевок и затирки

CS Aplikátor malt, plniv a spojňování
 RO Pompa injectat beton
 HU Habarcs, spatulázó massa és fuga kinyomó
 ES Aplicador de mortero, masilla y para juntas

660 mm

80x20 mm

PP

ABS

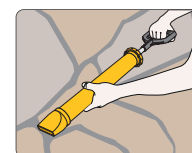

No.	L [mm]	
04450	660	24

EN Building and construction cement grouting gun
 PL Aplikator do zapraw, mas szpachlowych i fugowania
 DE Spritze für Mörtel-, Spachtel- und Fugenmaßen
 RU Аппликатор для строительных растворов, шпатлевок и затирки
 CS Aplikátor malt, plniv a spojiování
 RO Pompa injectat beton
 HU Habarcs, spatulázó massa és fuga kinyomó
 ES Aplicador de mortero, masilla y para juntas

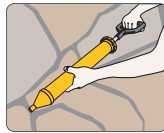
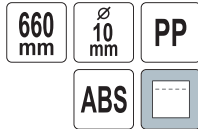

VOREL

No.	L [mm]	
04451	660	24

EN Foam gun
 PL Pistolet do pianki montażowej
 DE Schaumpistole
 RU Пистолет для нанесения полиуретановой пены
 CS Pistole na montážní pěnu
 RO Pistol pt. spumă
 HU Felrakó pisztoly, poliurethán habhoz
 ES Pistola para espuma de poliuretano



VOREL

No.	
09170	20

EN Foam gun
 PL Pistolet do pianki montażowej
 DE Schaumpistole
 RU Пистолет для нанесения полиуретановой пены
 CS Pistole na montážní pěnu
 RO Pistol pt. spumă
 HU Felrakó pisztoly, poliurethán habhoz
 ES Pistola para espuma de poliuretano



VOREL

No.	
09172	20

EN Building and construction cement grouting gun
 PL Aplikator do zapraw, mas szpachlowych i fugowania
 DE Spritze für Mörtel-, Spachtel- und Fugenmaßen
 RU Аппликатор для строительных растворов, шпатлевок и затирки
 CS Aplikátor malt, plniv a spojiování
 RO Pompa injectat beton
 HU Habarcs, spatulázó massa és fuga kinyomó
 ES Aplicador de mortero, masilla y para juntas

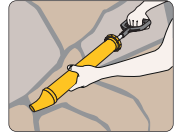
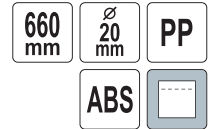

VOREL

No.	L [mm]	
04452	660	24

EN Foam gun
 PL Pistolet do pianki montażowej
 DE Schaumpistole
 RU Пистолет для нанесения полиуретановой пены
 CS Pistole na montážní pěnu
 RO Pistol pt. spumă
 HU Felrakó pisztoly, poliurethán habhoz
 ES Pistola para espuma de poliuretano



VOREL

No.	
09171	10/20

EN Foam gun
 PL Pistolet do pianki montażowej
 DE Schaumpistole
 RU Пистолет для нанесения полиуретановой пены
 CS Pistole na montážní pěnu
 RO Pistol pt. spumă
 HU Felrakó pisztoly, poliurethán habhoz
 ES Pistola para espuma de poliuretano



VOREL

No.	
09174	20

- EN Foam gun
- PL Pistolet do pianki montażowej
- DE Schaumpistole
- RU Пистолет для нанесения полиуретановой пены
- CS Pistolet na montážní pěnu
- RO Pistol pt. spumă
- HU Felrakó pisztoly, poliurethán habhoz
- ES Pistola para espuma de poliuretano



No.	09177	20
-----	-------	----

- EN Foam gun
- PL Pistolet do pianki montażowej
- DE Schaumpistole
- RU Пистолет для нанесения полиуретановой пены
- CS Pistolet na montážní pěnu
- RO Pistol pt. spumă
- HU Felrakó pisztoly, poliurethán habhoz
- ES Pistola para espuma de poliuretano



No.	09163	100
-----	-------	-----

- EN Hose clip
- PL Opaska ślimakowa
- DE Schlauchklemme
- RU Хомут стальной
- CS Šneková páska
- RO Colier metalic
- HU Csigapánt
- ES Hose clip



No.	Ø [mm]	W [mm]	100
73561	8-12	9	100
73562	10-16	9	100
73563	12-22	9	100
73565	16-27	9	100
73567	20-32	9	100
73568	25-40	9	100
73569	35-50	9	50
73570	40-60	9	50
73571	50-70	9	50
73572	60-80	9	25
73573	70-90	9	25
73574	80-100	9	25
73575	90-110	9	25

- EN Foam gun
- PL Pistolet do pianki montażowej
- DE Schaumpistole
- RU Пистолет для нанесения полиуретановой пены
- CS Pistolet na montážní pěnu
- RO Pistol pt. spumă
- HU Felrakó pisztoly, poliurethán habhoz
- ES Pistola para espuma de poliuretano



No.	09173	20
-----	-------	----

- EN Foam gun
- PL Pistolet do pianki montażowej
- DE Schaumpistole
- RU Пистолет для нанесения полиуретановой пены
- CS Pistolet na montážní pěnu
- RO Pistol pt. spumă
- HU Felrakó pisztoly, poliurethán habhoz
- ES Pistola para espuma de poliuretano



No.	09165	20
-----	-------	----

- EN Hose clip set
- PL Komplet opasek ślimakowych
- DE Schlauchklemmensatz
- RU Набор хомутов
- CS Sada šnekových pásek
- RO Set coliere metalice
- HU Csigapántkészlet
- ES Juego de abrazaderas sin fin



No.	pcs / szt.	25
73590	8	25

- EN Hose clip set
- PL Komplet opasek ślimakowych
- DE Schlauchklemmensatz
- RU Набор хомутов
- CS Sada šnekových pásek
- RO Set coliere metalice
- HU Csigapántkészlet
- ES Hose clip set



No.	Ø [mm]	W [mm]	pcs / szt.	4/40
73831	8-12	9	4	4/40
73833	12-22	9	4	40
73835	20-32	9	4	40

EN Hose clip set
 PL Komplet serwisowy
 DE Schlauchklemmensatz
 RU Набор хомутов
 CS Dělnická sada
 RO Set coliere metalice
 HU Szervizkészlet
 ES Juego de mantenimiento



No.	pcs / szt.	Box icon
73598	365	1

EN Screw clamp
 PL Obejma śrubowa
 DE Schraubklemme
 RU Винтовой зажим
 CS Šroubová svorka
 RO Colier metalic
 HU Csavaros csőbilincs
 ES Abrazadera de tornillo



No.	Ø [mm]	W [mm]	pcs / szt.	Box icon
73787	19-21	18	4	100
73788	21-23	18	4	75
73789	23-25	18	4	75
73790	25-27	18	4	75
73791	27-29	18	3	75
73792	29-31	20	3	75
73793	32-35	20	3	75
73794	35-38	20	2	100
73795	38-41	20	2	100
73796	40-43	20	1	100
73797	44-47	22	1	100
73798	48-51	22	1	100
73799	52-55	22	1	100
73800	56-59	22	1	100
73801	60-63	22	1	100
73802	64-67	22	1	100
73803	68-73	24	1	100
73804	74-79	24	1	100
73805	80-85	24	1	100
73806	86-91	24	1	100
73807	92-97	24	1	100
73808	98-103	24	1	100

EN Cable ties
 PL Opaski plastikowe
 DE Kabelbinder
 RU Хомуты-стяжки пластиковые
 CS Plastiková páska
 RO Set coliere din plastic
 HU Műanyag pánt
 ES Cable ties



No.	Size / Rozmiar [mm]	Max. tensile strength / Maks. odporność na zrywanie [kg]	Max. wire bundle diameter / Maks. średnica wiązki kabli [mm]	pcs / szt.	Box icon
73881	80x2.5	8	15	100	250/500
73882	100x2.5	8	20	100	250/500
73883	150x2.5	8	40	100	250/500
73884	200x2.5	8	50	100	125/250
73885	300x3.6	18	80	100	75/150

EN Screw clamp
 PL Obejma śrubowa
 DE Schraubklemme
 RU Винтовой зажим
 CS Šroubová svorka
 RO Colier metalic
 HU Csavaros csőbilincs
 ES Abrazadera de tornillo



No.	Ø [mm]	W [mm]	pcs / szt.	Box icon
73780	8-10	9	4	100
73781	10-12	9	4	100
73782	12-14	9	4	100
73783	14-16	9	4	100
73784	16-18	9	4	100
73785	18-20	9	4	100
73786	20-22	9	4	100

EN Cable ties
 PL Opaski plastikowe
 DE Kabelbinder
 RU Хомуты-стяжки пластиковые
 CS Plastiková páska
 RO Set coliere din plastic
 HU Műanyag pánt
 ES Cable ties



No.	Size / Rozmiar [mm]	Max. tensile strength / Maks. odporność na zrywanie [kg]	Max. wire bundle diameter / Maks. średnica wiązki kabli [mm]	pcs / szt.	Box icon
73892	100x2.5	8	20	100	250/500
73893	150x2.5	8	40	100	250/500
73894	200x2.5	8	50	100	125/250
73895	300x3.6	18	80	100	75/150
73929	280x4.8	22	80	100	50/100
73896	370x4.8	22	100	100	50/100
73897	430x4.8	22	120	100	35/70
73898	500x8.0	54	130	50	30/60



No.	Size / Rozmiar [mm]	Max. tensile strength / Maks. odporność na zrywanie [kg]	Max. wire bundle diameter / Maks. średnica wiązki kabli [mm]	pcs / szt.	Box icon
73906	200x4.8	22	50	100	75/150
73909	280x4.8	22	80	100	50/100
73886	370x4.8	22	100	100	50/100
73887	430x4.8	22	120	100	35/70
73888	500x8.0	54	130	50	30/60

EN Hook and loop cable ties
 PL Opaska rzepowa
 DE Klettkeblender
 RU Хомут на липучке
 CS Opaska na suchý zip
 RO Chinga cu bucla
 HU Tépözárás szalag
 ES Cinta con velcro

10 PCS NYLON PU



No.	Size / Rozmiar [mm]	pcs / szt.	
73840	150x25	10	50/100
73843	300x25	10	50/100
73845	450x25	10	50/100

EN Nylon cable tie gun
 PL Zaciskacz do opasek kablowych
 DE Kabelbinder Verschluss Werkzeug
 RU Пистолет для кабельных стяжек
 CS Kliešte viazacie káblové
 RO Cleste pt. strans coliere plastic
 HU Kábelkötégető fogó
 ES Pistola de amarre de cables

FOR CABLE TIES DO OPASEK KABLOWYCH 2.2x4.8 mm



No.	
73875	10/40

EN Glue sticks
 PL Wkłady klejowe
 DE Heisskleberatronen
 RU Тубы для клеящего пистолета
 CS Lepicí vložky
 RO Articole plastic (pt. pistol lipit)
 HU Ragasztóbetét
 ES Cartucho de cola

170-200 °C 85±2°C SOFTENING MEKANECE TRANSPARENT PRZEZROCYSTY UNIVERSAL UNWERSALNY



APPLICATION: - Cardboard, wood, plastic, leather, fabrics
 ZASTOSOWANIE: - Tektura, drewno, plastik, skóra, tkaniny



No.	Ø [mm]	L [mm]	pcs / szt.	
73260	7	100	12	50/200
73270	11	100	6	20/120
73271	11	150	12	20/60

EN Packing tape dispenser
 PL Podajnik taśmy pakowej
 DE Verpackungsband-Abroller
 RU Диспенсер для клейких лент
 CS Páskovačka
 RO Pistol cu banda de impachetare
 HU Csomagolószalag tépő
 ES Alimentador de la cinta de embalaje

76 mm 115 mm 50 mm



No.	W [mm]	
75295	50	12/24

EN Hook and loop cable ties
 PL Opaska rzepowa
 DE Klettkeblender
 RU Хомут на липучке
 CS Opaska na suchý zip
 RO Chinga cu bucla
 HU Tépözárás szalag
 ES Cinta con velcro

10 PCS NYLON PU



No.	Size / Rozmiar [mm]	pcs / szt.	
73850	150x25	10	50/100
73853	300x25	10	50/100
73855	450x25	10	50/100

EN Glue sticks
 PL Wkłady klejowe
 DE Heisskleberatronen
 RU Стержин для горячей склейки
 CS Lepicí vložky
 RO Mine cu clei
 HU Ragasztóbetét
 ES Cartucho de cola

170-200 °C 85±2°C SOFTENING MEKANECE TRANSPARENT PRZEZROCYSTY UNIVERSAL UNWERSALNY



APPLICATION: - Cardboard, wood, plastic, leather, fabrics
 ZASTOSOWANIE: - Tektura, drewno, plastik, skóra, tkaniny



No.	Ø [mm]	L [mm]	m [kg]	
73300	11	200	1	10

EN Glue applicator - bottle kit
 PL Dozownik kleju
 DE Applikator-Flasche für Flüssigklebstoffe
 RU Анпликатор клея
 CS Aplikátor lepidla
 RO Kit aplicator lipici
 HU Lamellaragasztó
 ES Dispensador de pegamento

0.25L PVA GLUE KLEJ

60 mm 60 mm 40 mm



No.	
78027	50

EN Packing tape, brown
 PL Taśma pakowa brązowa
 DE Verpackungsband aus PP, braun
 RU Упаковочная клейкая лента
 CS Balící páska PP hnědá
 RO Bandă ambalare PP maro
 HU PP barna ragasztószalag
 ES Packing tape, brown

OPP



No.	W [mm]	L [m]	
75301	48	40	36
75302	48	66	36

EN Packing tape, transparent
 PL Taśma pakowa przezroczysta
 DE Verpackungsband aus PP, durchsichtig
 RU Упаковочная клейкая лента
 CS Balící páska PP průhledná
 RO Bandă ambalare PP transparentă
 HU Átlátszó ragasztószalag
 ES Packing tape, transparent



VOREL

No.	W [mm]	L [m]	
75303	48	40	36
75304	48	66	36

EN Self adhesive paper tape
 PL Taśma papierowa samoprzylepna
 DE Papierband selbstklebend
 RU Лента малярная бумажная

CS Páska papírová samolepící
 RO Banda adeziva hartie
 HU Öntapadó papírszalag
 ES Self adhesive paper tape



VOREL

No.	W [mm]	L [m]	
75270	19	25	12/48
75271	25	25	36
75272	30	25	10/40
75273	38	25	6/24
75274	48	25	6/24
75285	25	50	9/36
75286	30	50	10/40
75287	38	50	6/24
75288	48	50	6/24

EN Double-sided carpet tape
 PL Taśma dwustronna do wykładzin
 DE Doppelseitiges Klebeband für Auslegware
 RU Двухсторонняя клейкая лента для укладки ковровых покрытий
 CS Obojstranná lepicí páska (na podlahové krytiny)
 RO Bandă cu două părți adezive pt. mochete
 HU Kétoldalas szalag szőnyegpadlókhöz
 ES Double-sided carpet tape

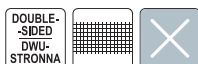

VOREL

No.	W [mm]	L [m]	
75260	50	5	48
75261	50	10	36
75262	50	25	24

EN Packing tape
 PL Taśma pakowa
 DE Band
 RU Упаковочная клейкая лента
 CS Balící páska
 RO Banda scotch
 HU Csomagolószalag
 ES Cinta de embalaje



No.	W [mm]	L [m]	
75300	48	45	12/36

EN Blue masking tape
 PL Taśma maskująca, niebieska
 DE Malerei blau Tape
 RU Малярна стрічка

CS Maskovací páska
 RO Bandă de mascare
 HU Fedőszalag
 ES Blue masking tape



VOREL

No.	W [mm]	L [m]	
75120	30	25	40
75121	38	25	24
75122	48	25	24
75123	30	50	40
75124	38	50	24
75125	48	50	24

EN Plastering tape
 PL Taśma tynkarska elewacyjna
 DE Putzband
 RU Штукатурные лента
 CS Fasádní omítková páska
 RO Banda mascare pt. tencuieii
 HU Homlokzati festő szalag
 ES Plastering tape



VOREL

No.	W [mm]	L [m]	
75130	38	20	24
75131	48	20	24
75132	38	50	28
75133	48	50	24

EN Double-sided tape
 PL Taśma dwustronna na folii
 DE Doppelseitiges Band auf PP-Folie
 RU Клейкая лента двухсторонняя на полипропиленовой основе
 CS Obojstranná páska na PP folii
 RO Bandă cu două fețe pt. folii
 HU Kétoldalas
 ES Double-sided tape



VOREL

No.	W [mm]	L [m]	
75245	50	5	72
75246	50	10	72
75247	50	25	36

- EN Mounting tape
- PL Taśma samoprzylepna dwustronna
- DE Doppelseitiges Montageband
- RU Двухсторонняя монтажная лента
- CS Páska montážní dvouvrstvá
- RO Scotch cu banda dubla
- HU Kétoldalas ragasztószalag
- ES Cinta adhesiva de doble cara



2
PCS

2.25m
19mm

5m
19mm



No.	W [mm]	L [m]	
75100	19	2.25, 5	12/96

- EN Warning tape
- PL Taśma ostrzegawcza
- DE Warnband, klebend
- RU Лента сигнальная
- CS Lepicí páska výstražná
- RO Bandă adevizivă avertizare
- HU Figyelmeztető ragasztó szalag
- ES Cinta de advertencia



SELF-ADHESIVE SAMO-PRZYLEPNA

PVC



No.	W [mm]	L [m]	
75231	48	33	24

- EN Two-colour warning tape
- PL Taśma ostrzegawcza dwukolorowa
- DE Zweifarbiges Warnband
- RU Лента сигнальная
- CS Páska výstražná dvojbarevná
- RO Banda de avertizare bicolora
- HU Kétszínű jelzőszalag
- ES Cinta de advertencia bicolor



No.	W [mm]	L [m]	
75233	75	100	24

- EN PVC Tape
- PL Taśma PCV
- DE PVC Band
- RU Изолента ПВХ
- CS Páska PVC
- RO Banda izolatoare PVC
- HU PVC szalag
- ES Cinta PVC



No.	W [mm]	Thickness / Grubość [mm]	L [mm]	pcs / szt.	
75000	19	0.13	10	10	50
75050	50	0.13	10	1	25/100

- EN „DUCT” tape
- PL Taśma tekstylna „DUCT”
- DE Textilband „DUCT”
- RU Лента армированная на тканевой основе
- CS Textilní páska „DUCT”
- RO Bandă textilă „DUCT”
- HU „DUCT” textil szalag
- ES „DUCT” tape



DUCT



No.	W [mm]	L [m]	
75238	48	10	24
75239	38	50	28
75240	48	50	24

- EN Warning tape
- PL Taśma ostrzegawcza
- DE Warnband, klebend
- RU Лента сигнальная
- CS Lepicí páska výstražná
- RO Bandă adevizivă avertizare
- HU Figyelmeztető ragasztó szalag
- ES Cinta de advertencia



SELF-ADHESIVE SAMO-PRZYLEPNA

PVC



No.	W [mm]	L [m]	
75230	48	33	24

- EN Aluminium tape
- PL Taśma aluminiowa
- DE Aluminiumband
- RU Алюминиевая клейкая лента
- CS Hliníková páska
- RO Bandă aluminiu
- HU Alumínium szalag
- ES Aluminium tape



Al



No.	W [mm]	L [m]	
75140	48	10	36
75141	48	50	24

- EN PVC Tape
- PL Taśma PCV
- DE PVC Band
- RU Изолента ПВХ
- CS Páska PVC
- RO Banda izolatoare PVC
- HU PVC szalag
- ES Cinta PVC



6
PCS

No.	W [mm]	Thickness / Grubość [mm]	L [mm]	pcs / szt.	
75060	19	0.13	3	6	10/100

EN Set of PVC insulating tapes
 PL Zestaw taśm izolacyjnych PCV
 DE Satz von PVC-Isolierbändern
 RU Set of PVC insulating tapes
 CS Sada izolačních pásek PVC
 RO Set de benzi de izolare din PVC
 HU PVC szigetelő szalag készlet
 ES Set of PVC insulating tapes

10
PCS



No.	W [mm]	Thickness / Grubość [mm]	L [mm]	pcs / szt.	
75012	15	0.13	10	10	36
75028	19	0.13	20	10	20

EN Self-vulcanization tape
 PL Taśma samowulkanizująca
 DE Selbstvulkanisierendes Band
 RU Самовулканизирующаяся лента
 CS Páska samovulkanizační
 RO Banda autovulcanizanta
 HU Ön vulkanizáló szalag
 ES Self-vulcanization tape



No.	W [mm]	Thickness / Grubość [mm]	L [m]	
75035	19	0.8	10	5/30
75036	25	0.8	5	5/30

EN Builders line
 PL Sznurek murarski
 DE Maurerschnur
 RU Шнур - причалка
 CS Šňůra zednická
 RO Sfoară pt. zidari
 HU Kőműves zsinór
 ES Cuerda de albañil

EASY
ROLL-UP
LÄTWE
ZWIJANIE

PP



VOREL

No.	Ø [mm]	L [m]	
17497	1.2	75	12/48

EN Builders line
 PL Sznurek murarski
 DE Maurerschnur
 RU Шнур - причалка
 CS Šňůra zednická
 RO Sfoară pt. zidari
 HU Kőműves zsinór
 ES Cuerda de albañil



No.	L [m]	Color / Kolor	
17488	50	zółty	60
17489	100	zółty	60

EN PVC tape
 PL Taśma PCV do użytku zewnętrznego
 DE PVC Band
 RU Лента ПВХ для внешних работ
 CS Páska PVC
 RO Bandă PVC
 HU Kétoldalas PVC
 ES Cinta de PVC para exteriores

Juv

PVC



VOREL

No.	W [mm]	L [m]	
75031	48	33	50

EN Builders line
 PL Sznurek murarski
 DE Maurerschnur
 RU Шнур - причалка
 CS Šňůra zednická
 RO Sfoară pt. zidari
 HU Kőműves zsinór
 ES Cuerda de albañil

75m

EASY
ROLL-UP
LÄTWE
ZWIJANIE

PE



VOREL

No.	L [m]	
17495	75	12/48

EN Builders line
 PL Sznurek murarski
 DE Maurerschnur
 RU Шнур - причалка
 CS Šňůra zednická
 RO Sfoară pt. zidari
 HU Kőműves zsinór
 ES Cuerda de albañil

EASY
ROLL-UP
LÄTWE
ZWIJANIE

PP



VOREL

No.	Ø [mm]	L [m]	
17498	1.2	200	12/48

EN Builders line
 PL Sznurek murarski
 DE Maurerschnur
 RU Шнур - причалка
 CS Šňůra zednická
 RO Sfoară pt. zidari
 HU Kőműves zsinór
 ES Cuerda de albañil

40m



No.	L [m]	
17490	40	80

EN Polypropylene sennit line
 PL Linka pleciona polipropylenowa
 DE Geflochtenes Seil aus Polypropylen
 RU Канат полипропиленовый плетеный

CS Lano pletené polypropylenové
 RO Coarda împletită din polipropilena
 HU Polipropilén fonott kötél
 ES Cuerda trenzada de polipropileno



VOREL

No.	Ø [mm]	L [m]	
69502	4	400	1
69503	5	250	1
69504	6	250	1
69505	8	300	1
69506	10	200	1
69507	12	180	1
69508	14	110	1
69509	16	80	1
69510	18	70	1



EN Polypropylene bricklayer's string
 PL Sznurek murarski, polipropylenowy
 DE Maurerschnur aus Polypropylen
 RU Шнур каменщика
 CS Šňůra zednická polypropylenová
 RO Șnur de zidărie din polietilena
 HU Kőműves zsinór, polipropilén
 ES Cordel de albañilería



VOREL

No.	Ø [mm]	L [m]	
17470	1.7	50	60/240
17471	1.7	100	30/120
17473	2.0	50	60/240
17474	2.0	100	30/120

EN Polyethylene bricklayer's string
 PL Sznurek murarski polietylenowy
 DE Maurerschnur aus Polyäthylen
 RU Полиэтиленовый шнур каменщика
 CS Šňůra zednická polyetylenová
 RO Șnur de zidărie din polietilena
 HU Kőműves zsinór, polietilén
 ES Cordel de albañilería de polietileno



VOREL

No.	Ø [mm]	L [m]	
17480	1.7	50	60/240
17481	1.7	100	30/120
17483	2.0	50	60/240
17484	2.0	100	30/120

EN Polypropylene sennit line
 PL Linka pleciona polipropylenowa
 DE Geflochtenes Seil aus Polypropylen
 RU Канат полипропилен
 CS Lano pletené polypropylenové
 RO Coarda împletită din polipropilena
 HU Polipropilén fonott kötél
 ES Cuerda trenzada de polipropileno



VOREL

No.	Ø [mm]	L [m]	
69521	4	20	50

EN Universal PP sennit string
 PL Sznurek PP pleciony, uniwersalny
 DE PP-Schnur, geflochten, universell
 RU Шнур полипропиленовый

CS Šňůra PP pletená univerzální
 RO Șnur PP împletit, universal
 HU PP fonott kötél, univerzális
 ES Cordel trenzado universal PP



VOREL

No.	Ø [mm]	L [m]	
69620	3	10	50
69621	3	20	40

EN String jute rope
 PL Lina jutowa skręcana
 DE Verdrillt Seil aus Jute
 RU Канат джутовый

CS Lano jutová kroucená
 RO Cablu răsucit de iuta
 HU Juta sodrott kötél
 ES Cable de yute torcido



EN Packing jute string
 PL Sznurek pakowy, jutowy
 DE Packschnur, aus Jute
 RU Шнур джутовый

CS Šňůra ucpávková jutová
 RO Șnur de împachetat, de iuta
 HU Csomagkötöző spárga, juta
 ES Cordel de yute para embalaje



VOREL

No.	Ø [mm]	L [m]	
69572	10	10	20

VOREL

No.	m [g]	
69630	50	112
69631	100	100

EN Flax thread, twine
 PL Nici lina, dratwa
 DE Leinenfaden, Pechfaden
 RU Нить (дратва) льняная

CS Nitě lněné, dratev
 RO Fire de in, fire
 HU Len cérna, fonál
 ES Hilo de lino, cabo de zapatero



VOREL

No.	m [g]	
69635	100	28
69637	250	18

EN Elastic sennit line
 PL Linka pleciona, elastyczna
 DE Geflochtenes Seil, elastisch
 RU Канат плетеный эластичный
 CS Lano pletené elastické
 RO Coarda împletită, elastică
 HU Fonott kötél, rugalmas
 ES Cuerda trenzada elástica



RUBBER
 CORE
 GUMOWY
 RDZEN

PP



VOREL

No.	Ø [mm]	L [m]	
69550	6	150	1
69551	8	100	1
69552	10	100	1

EN Needle rope
 PL Lina igłowa
 DE Nadelseil
 RU Канат полипропиленовый, плетеный
 CS Lano s jádrem opletené
 RO Cablu ac
 HU Tűfonatos kötél
 ES Cable acalabrotado

PP



VOREL

No.	Ø [mm]	L [m]	
69539	8	10	30
69540	8	20	20
69542	10	10	25
69543	10	20	15
69546	12	20	10

EN Spliced wire polypropylene string
 PL Sznurek PP do podwiązania wełny izolacyjnej
 DE Polypropylen Emtegar
 RU Шнур полипропиленовый
 CS Provázek polypropylenový
 RO Snur din polipropilena
 HU Spagát polypropylenový
 ES Cuerda

PP



VOREL

No.	Ø [mm]	L [m]	
69608	2.5	200	100
69609	2.5	300	80
69610	2.5	450	50
69612	2.5	1000	24
69613	2.5	2000	12

Memo

11

Plastering & bricklaying tools Narzędzia budowlane i malarskie



Floor laminate cutters Gilotyny do cięcia paneli podłogowych	
.....	150

Tile cutters & accessories Przyrządy do cięcia glazury i akcesoria	
.....	150-158

Tile cutters Przyrządy do glazury	150
---	-----

Tile cutting pliers Szczypce do glazury	151
---	-----

Grout removers & finishers Skrobaki i szpachelki do fug	151
---	-----

Accessories for tiles Akcesoria do glazury	152
--	-----

Burners & soldering tools Palniki i lutownice	
.....	158-159

Gas burners & accessories Palniki gazowe i akcesoria	
.....	159-160

Ladders & supports Drabiny i podpory	
.....	160-163

Masonry tools Narzędzia budowlane	
.....	163-187

Floats Pace	163
-----------------------	-----

Trowels Kielnie	165
---------------------------	-----

Plaster & stucco spray guns Tynkownice pneumatyczne	166
---	-----

Tools for areated blocks Narzędzia do betonu komórkowego	166
--	-----

Tools for drywalls Narzędzia do płyt gipsowo-kartonowych	167
--	-----

Putty knives Szpachelki	168
-----------------------------------	-----

Scrapers Skrobaki	170
-----------------------------	-----

Mason's pans Czerpaki murarskie	171
---	-----

Building strainers Sita budowlane	172
---	-----

Paint mixers & grout mixers Mieszadła do farb i do zaprawy	172
--	-----

Wallpapering tools Narzędzia do tapetowania	174
---	-----

Paint rollers & accessories Wałki do malowania i akcesoria	174
--	-----

Paint brushes & accessories Pędzle malarskie i akcesoria	177
--	-----

Multipurpose trays Podstawki gospodarcze	179
--	-----

Painting sheets Folie malarskie	179
---	-----

Tapes Taśmy	180
-----------------------	-----

Plastic buckets & tubs Wiadra i kasty budowlane	182
---	-----

Suction lifters Uchwyty do szyb	183
---	-----

Hooks „Juco” Haki budowlane „Juco”	184
--	-----

Carpenter's pencils & accessories Ołówki stolarskie i akcesoria	184
---	-----

Benders Giętarek	184
----------------------------	-----

Paving tools Narzędzia brukarskie	185
---	-----

EN Floor laminate cutter
 PL Gilotyna do cięcia paneli podłogowych
 DE Laminat-Schneider
 RU Гильотина для ламината
 CS Nůžky na laminátové plovoucí podlahy
 RO Aparat de tăiat parchet laminat
 HU Laminált padló vágógép
 ES Guillotina cortapaneles



No.	Cutting length / Długość cięcia [mm]	Guide bar diameter / Średnica prowadnicy [mm]	Cube icon
28880			2

EN Tile cutting machine
 PL Przyrząd do cięcia glazury
 DE Fliesenschneidmaschine
 RU Плиткорез
 CS Přístroj na řezání glazury
 RO Mașină pt. tăiat gresie si faianta
 HU Csempevágó
 ES Cortadora de gres

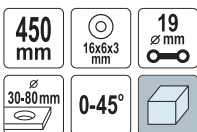

No.	Cutting length / Długość cięcia [mm]	Guide bar diameter / Średnica prowadnicy [mm]	Cube icon
00320	450	19	1

EN Tile cutting machine
 PL Przyrząd do cięcia glazury
 DE Fliesenschneidmaschine
 RU Плиткорез
 CS Přístroj na řezání glazury
 RO Mașină pt. tăiat gresie si faianta
 HU Csempevágó
 ES Cortadora de gres

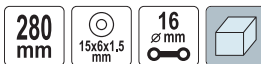

No.	Cutting length / Długość cięcia [mm]	Guide bar diameter / Średnica prowadnicy [mm]	Cube icon
02300	280	16	6

EN Tile cutting machine
 PL Przyrząd do cięcia glazury
 DE Fliesenschneidmaschine
 RU Плиткорез
 CS Přístroj na řezání glazury
 RO Mașină pt. tăiat gresie si faianta
 HU Csempevágó
 ES Cortadora de gres



No.	Cutting length / Długość cięcia [mm]	Guide bar diameter / Średnica prowadnicy [mm]	Cube icon
02400	400	14	6

EN Tile cutting machine
 PL Przyrząd do cięcia glazury
 DE Fliesenschneidmaschine
 RU Плиткорез
 CS Přístroj na řezání glazury
 RO Mașină pt. tăiat gresie si faianta
 HU Csempevágó
 ES Cortadora de gres

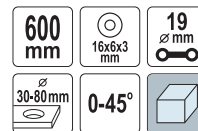

No.	Cutting length / Długość cięcia [mm]	Guide bar diameter / Średnica prowadnicy [mm]	Cube icon
00300	600	19	1

EN Tile cutting machine
 PL Przyrząd do cięcia glazury
 DE Fliesenschneidmaschine
 RU Плиткорез
 CS Přístroj na řezání glazury
 RO Aparat de tăiat faianta
 HU Csempevágó
 ES Cortadora de gres



No.	Cutting length / Długość cięcia [mm]	Guide bar diameter / Średnica prowadnicy [mm]	Cube icon
00510	500	16	1
00610	590	16	1

EN Tile cutting machine
 PL Przyrząd do cięcia glazury
 DE Fliesenschneidmaschine
 RU Плиткорез
 CS Přístroj na řezání glazury
 RO Mașină pt. tăiat gresie si faianta
 HU Csempevágó
 ES Cortadora de gres



No.	Cutting length / Długość cięcia [mm]	Guide bar diameter / Średnica prowadnicy [mm]	Cube icon
01060	600	15	1

EN Tile cutting wheel
 PL Kółko wymienne ze śrubą
 DE Schneidrad mit Schraube
 RU Запасной ролик для плиткореза

CS Výměnné kolečko se šroubem
 RO Cutit rola
 HU Cseregörgő csavarral
 ES Recambio de cuchillo redondo



No.	Dimensions / Wymiary [mm]	For / Dla	Cube icon
03150	15x6x1.5	02300, 02400	50/200
03160	16x6x3	00300, 00320	50/200
03220	22x6x2	00510, 00600, 00610, 01060	50/200

EN Tile cutting wheel
 PL Kółko tnące wymienne
 DE Schneiderrad
 RU Запасной ролик для плиткореза
 CS Výměnné kolečko
 RO Cuițt rolă
 HU Cseregörgő csavarral
 ES Recambio de cuchillo redondo



VOREL

No.	Dimensions / Wymiary [mm]	For / Dla	
03221	22x10.5x2	00703	50/200

EN Tile cutting pliers
 PL Szczypce do glazury
 DE Glasurzange
 RU Кусачки для плитки

CS Kleště do glazury
 RO Clește rupt faianta
 HU Csempefogó
 ES Tenazas para azulejos



VOREL

No.	L [mm]	
04000	200	10/60

EN Tile cutting pliers
 PL Szczypce do łamania glazury
 DE Glasurzange
 RU Кусачки для плитки

CS Kleště do glazury
 RO Clește rupt faianta
 HU Csempefogó
 ES Tenazas para azulejos



VOREL

No.	L [mm]	
04022	200	6/60

EN Tile cutting nipper
 PL Obcęgi do glazury wygięte
 DE Glasurzange
 RU Клещи для плитки твердосплавные

CS Kleště do glazury ohnuté
 RO Clește curbate pt. glazură
 HU Hajlított csempe harapófogó
 ES Tenazas para azulecos curvos



VOREL

No.	L [mm]	
04210	200	12/60

EN Tile cutting wheel
 PL Kółko tnące wymienne
 DE Schneiderrad
 RU Ролик для плиткореза
 CS Výměnné kolečko
 RO Cuițt rolă
 HU Cseregörgő csavarral
 ES Recambio de cuchillo redondo



VOREL

No.	Dimensions / Wymiary [mm]	
03225	22x6x6	500

EN Tile cutting pliers
 PL Szczypce do cięcia glazury
 DE Glasurzange
 RU Кусачки для плитки

CS Kleště do glazury
 RO Clește rupt faianta
 HU Csempefogó
 ES Tenazas para azulejos



VOREL

No.	L [mm]	
04020	200	6/36

EN Tile cutting nipper
 PL Szczypce do glazury
 DE Glasurzange
 RU Кусачки для плитки

CS Kleště do glazury
 RO Clește rupt faianta
 HU Csempefogó
 ES Tenazas para azulejos



VOREL

No.	L [mm]	
04200	200	12/60

EN Grout remover
 PL Skrobak do fug
 DE Fugenreiniger
 RU Скребок для швов плитки

CS Škrabák na spáry
 RO Spaclu pt. rosturi
 HU Fugakihűző
 ES Rascador para juntas



VOREL

No.	
04400	40/400

- EN Grout finisher
- PL Szpachelka do fugi
- DE Fugenreiniger
- RU Шпатель для затирки межплиточных швов
- CS Šuves skrěpers
- RO Răzuitoare pt. rosturi
- HU Fugakihúzó
- ES Rascador para juntas



VOREL

No.		
04410		450

- EN Grout remover
- PL Skrobak do fugi
- DE Fugenreiniger
- RU Скребок для швов плитки
- CS Škrabák na spáry
- RO Spaclu pt. rosturi
- HU Fugakihúzó
- ES Rascador para juntas



VOREL

No.	Blade size / Rozmiar ostrza [mm]	
04405	50x2	12/60

- EN Circular tile cutter
- PL Wycinarka do otworów w glazurze
- DE Fliesenbohrzeug
- RU Резак по плитке
- CS Výseč otvorů v glazuře
- RO Cutit rotativ taiat faianta
- HU Lyukkivágó csempéhez
- ES Ruleta de corte para azulejos



VOREL

No.	Cutting diameter / Šrednica cięcia [mm]	
03900	20-90	20/80

- EN Spare blades for tile cutter
- PL Ostrze zapasowe do wycinarki
- DE Schneide für Fliesenlocher
- RU Запасные элементы для резака
- CS Náhradní soustava na vystřihováčku
- RO Lame rezerva pt. cutit
- HU Tartalékészlet a kivágóhoz
- ES Juego de recambios para ruleta



VOREL

No.	For / Dla	
03950	03940	20/200

- EN Grout bag
- PL Worek do aplikacji fugi
- DE Fugenfüller-beutel
- RU Мешок для нанесения расшивки
- CS Rukáv do spárování
- RO Punga umplere rosturi
- HU Fugázó zsák
- ES Saco para la aplicación de juntas

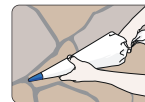

VOREL

No.		
04440		36/108

- EN Tile laser
- PL Laser glazuricy
- DE Fliesenlaser
- RU Лазерный уровень для пластин
- CS Laserová vodováha
- RO Nivel laser pt. plăci
- HU Csempélézer
- ES Láser de baldosas



VOREL

No.	Vials / Libelle	
16030	2	20

- EN Circular tile cutter
- PL Wycinarka do otworów w glazurze
- DE Fliesenlochbohrer mit Handschutz
- RU Резак по плитке „Балеринка” с защитной решеткой
- CS Výseč otvorů v glazuře
- RO Cutit rotativ taiat faianta
- HU Lyukkivágó csempéhez
- ES Ruleta de corte para azulejos



VOREL

No.	Cutting diameter / Šrednica cięcia [mm]	
03940	20-94	24

- EN Adjustable plastic drill guide
- PL Prowadnica do wiercenia w płytkach ceramicznych
- DE Führungsschiene zum Bohren in Keramikfliesen
- RU Направляющая для сверления керамической плитки
- CS Vodítko pro vrtání keramických obkladaček
- RO Ghidaj gaurire ajustabil
- HU Fúrószár vezető kerámia csempékhez
- ES Guía para taladrar en azulejos cerámicos



VOREL

No.	Cutting diameter / Šrednica cięcia [mm]	
03960	4-24, 25-84	40

EN Hand tile cutter and breaker
 PL Rysik do cięcia glazury
 DE Fliesengriffel
 RU Резак для плитки
 CS Rýsovací jehla na řezání glazury
 RO Cuită taiat / rupt faianța
 HU Karctű csempevágáshoz
 ES Cortador de azulejos



VOREL

No.	L [mm]	
04050	130	50/400

EN Tile leveling set
 PL Przyrząd do poziomowania płytek
 DE Schlagschnurgerät
 RU Уровень для укладки кафеля
 CS Přístroj pro regulaci úrovně dlaždiček
 RO Fir pt. trasat
 HU Padlólapszintező eszköz
 ES Nivelador de cuerda para azulejos

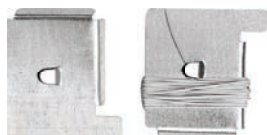
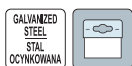

No.		
04500		60

EN Tile magnetic fittings
 PL Uchwyty magnetyczne do płytek
 DE Fliesen Magnete
 RU Магнитные фитинги для плитки
 CS Magnety pod obklady
 RO Balamale magnetice pt. imbinarea placilor
 HU Csempeágnés
 ES Trampilla magnética para la escotilla de inspección

4
PCS

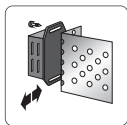
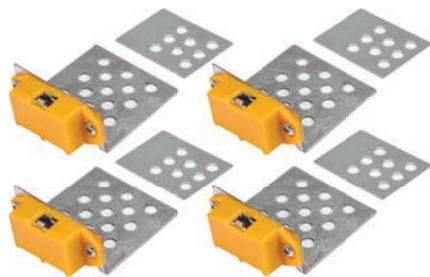

VOREL

No.	pcs / szt.	
04490	4	50/100

EN Hygroscopic glazing sponge
 PL Gąbka glazurująca hydrochłonna
 DE Wasseraufsaugender Fliesenschwamm
 RU Губка для затирки плитки
 CS Houbka na spráování obkladů nasávká
 RO Burete pt. plăci ceramice hidroabsorbant
 HU Nedvszívó csempező szivacs
 ES Esponja para esmaltar

VOREL

No.	Dimensions / Wymiary [mm]	
04542	170x110x60	56

EN TC tile cutter and breaker
 PL Rysik do cięcia i łamania glazury
 DE Fliesengriffel und Brecher
 RU Плиткорез-карандаш с отламывателем

CS Rýsovací jehla na řezání a lámání glazury
 RO Cuită taiat / rupt faianța
 HU Karctű csempevágáshoz és töréshez
 ES Cortador y rompedor de azulejos

200
mm



No.	L [mm]	
04100	200	6/120

EN Magnetic lock
 PL Maskownica uniwersalna
 DE Universal verdeckung mit Magnet
 RU Замок магнитный для кафеля
 CS Maskovací rám univerzální do glazury
 RO Opritor magnetic
 HU Univerzális maszkoló csempehez
 ES Cierre magnético universal

4
PCS



VOREL

No.		
04510		40

EN Glazing sponge
 PL Gąbka glazurująca
 DE Fliesenschwamm
 RU Губка для затирки плитки
 CS Houbka na spráování obkladů
 RO Burete pt. plăci ceramice
 HU Csempező szivacs
 ES Esponja para esmaltar

PU



VOREL

No.	Dimensions / Wymiary [mm]	
04540	165x100x60	74

PU



- EN Double glazing sponge
- PL Gąbka glazurująca dwuwarstwowa
- DE Doppeller Fliesenschwamm
- RU Губка для затирки плитки
- CS Houba na spárování obkladů dvoustranná
- RO Burete pt. plăci ceramice dublu
- HU Dupla csempéző szivacs
- ES Esponja para esmaltar doble



No.	Dimensions / Wymiary [mm]	
04544	165x100x80	18

- EN Glaze bucket
- PL Wiadro glazurujące
- DE Fliesenwaschset Rolleneimer
- RU Ведро с роликом для затирки швов
- CS Malířské vědro
- RO Galeata pt. zugravit
- HU Fugázó vödör
- ES Cubo de pintura



No.	Capacity / Pojemność [l]	
00250	10	2

- EN Tile leveling system (clips)
- PL System poziomowania płytek (klipsy)
- DE Fliesen Nivelliersystem (Clips)
- RU Система выравнивания плитки (зажимы)
- CS Systém vyrovnávání dlaždic (spony)
- RO Sistem nivelare plăci (cleme)
- HU Csempeszintező rendszer (talpak)
- ES Sistema de nivelación de baldosas (clips)

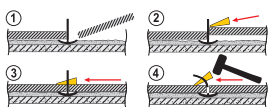

FEATURES:

- Useful when laying tiles on floors and walls
- Work great for large tiles
- Use with tiles of different thickness
- For use with 04718 wedges
- Save time and make work easy and efficient

CECHY:

- Ułatwia układanie płytek na ścianach i podłodze
- Szczególnie przydatny do płytek o większych rozmiarach
- Umożliwia poziomowanie płytek o różnych grubościach
- Do użytku z klinami 04718
- Ułatwia i przyspiesza pracę

30x30	33x33	40x40	45x45	50x50	60x60	80x80	60x30	100x50	120x60
42	36	20	28	24	10	10	22	16	10

NUMBER OF CLIPS FOR VARIOUS DIMENSIONS TILES PER 1 M³
LICZBA KLIPSÓW NA M³ W ZALEŻNOŚCI OD ROZMIARU PŁYTKI



No.	pcs / szt.	
04690	100	15

- EN Rubber glazing sponge
- PL Gąbka glazurująca gumowa
- DE Gummi-Fliesenschwamm
- RU Губка для затирки плитки
- CS Houba na spárování obkladů gumová
- RO Burete pt. plăci ceramice de cauciuc
- HU Gumi csempéző szivacs
- ES Esponja para esmaltar de goma



No.	Dimensions / Wymiary [mm]	
04546	150x100x50	10

- EN Tile leveling floor pliers
- PL Szczypce do poziomowania płytek
- DE Nivelliersystem Zange
- RU Щипцы до системы нивелировки
- CS Kleště pro dlaždice vyrovnání
- RO Cleste de nivelat gresie reglabil
- HU Lapszintező speciális fogó
- ES Tenaza para sistema de nivelación



No.		
04699		5/30

- EN Tile leveling system (clips and wedges)
- PL System poziomowania płytek (klipsy i kliny)
- DE Fliesen Nivelliersystem (Clips und Keile)
- RU Система выравнивания плитки (зажимы и клинья)
- CS Systém vyrovnávání dlaždic (spony a kliny)
- RO Sistem nivelare plăci (cleme și pene)
- HU Csempeszintező rendszer (talpak és ékek)
- ES Sistema de nivelación de baldosas (clips y cuñas)

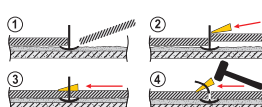
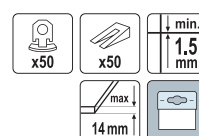

FEATURES:

- Useful when laying tiles on floors and walls
- Work great for large tiles
- Use with tiles of different thickness
- Wedges are reusable
- Save time and make work easy and efficient

CECHY:

- Ułatwia układanie płytek na ścianach i podłodze
- Szczególnie przydatny do płytek o większych rozmiarach
- Umożliwia poziomowanie płytek o różnych grubościach
- Kliny wielokrotnego użytku
- Ułatwia i przyspiesza pracę

30x30	33x33	40x40	45x45	50x50	60x60	80x80	60x30	100x50	120x60
42	36	20	28	24	10	10	22	16	10

NUMBER OF CLIPS FOR VARIOUS DIMENSIONS TILES PER 1 M³
LICZBA KLIPSÓW NA M³ W ZALEŻNOŚCI OD ROZMIARU PŁYTKI



No.	pcs / szt.	
04691	50+50	15

EN Tile leveling system (clips and wedges)
 PL System poziomowania płytek (klipsy i kliny)
 DE Fliesen Nivelliersystem (Clips und Keile)
 RU Система выравнивания плитки (зажимы и клинья)
 CS Systém vyrovnávání dlaždic (spony a klíny)
 RO Sistem nivelare plăci (cleme și pene)
 HU Csempezintező rendszer (talpak és ékek)
 ES Sistema de nivelación de baldosas (clips y cuñas)

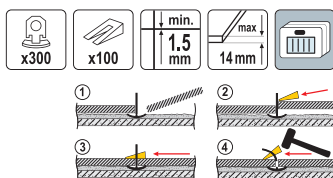

FEATURES:

- Useful when laying tiles on floors and walls
- Work great for large tiles
- Use with tiles of different thickness
- Wedges are reusable
- Save time and make work easy and efficient

CECHY:

- Ułatwia układanie płytek na ścianach i podłodze
- Szczególnie przydatny do płytek o większych rozmiarach
- Umożliwia poziomowanie płytek o różnych grubościach
- Kliny wielokrotnego użytku
- Ułatwia i przyspiesza prace



30x30	33x33	40x40	45x45	50x50	60x60	80x80	60x30	100x50	120x60
42	36	20	28	24	10	10	22	16	10

NUMBER OF CLIPS FOR VARIOUS DIMENSIONS TILES PER 1 M²
 LICZBA KLIPSÓW NA M² W ZALEŻNOŚCI OD ROZMIARU PŁYTKI



No.	pcs / szt.	
04692	300+100	1

EN Tile leveling system (clips and wedges)
 PL System poziomowania płytek (klipsy i kliny)
 DE Fliesen Nivelliersystem (Clips und Keile)
 RU Система выравнивания плитки (зажимы и клинья)
 CS Systém vyrovnávání dlaždic (spony a klíny)
 RO Sistem nivelare plăci (cleme și pene)
 HU Csempezintező rendszer (talpak és ékek)
 ES Sistema de nivelación de baldosas (clips y cuñas)

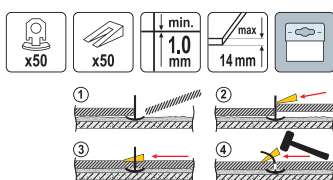

FEATURES:

- Useful when laying tiles on floors and walls
- Work great for large tiles
- Use with tiles of different thickness
- Wedges are reusable
- Save time and make work easy and efficient

CECHY:

- Ułatwia układanie płytek na ścianach i podłodze
- Szczególnie przydatny do płytek o większych rozmiarach
- Umożliwia poziomowanie płytek o różnych grubościach
- Kliny wielokrotnego użytku
- Ułatwia i przyspiesza prace



30x30	33x33	40x40	45x45	50x50	60x60	80x80	60x30	100x50	120x60
42	36	20	28	24	10	10	22	16	10

NUMBER OF CLIPS FOR VARIOUS DIMENSIONS TILES PER 1 M²
 LICZBA KLIPSÓW NA M² W ZALEŻNOŚCI OD ROZMIARU PŁYTKI



No.	pcs / szt.	
04714	50+50	15

EN Tile leveling system (clips)
 PL System poziomowania płytek (klipsy)
 DE Fliesen Nivelliersystem (Clips)
 RU Система выравнивания плитки (зажимы)
 CS Systém vyrovnávání dlaždic (spony)
 RO Sistem nivelare plăci (cleme)
 HU Csempezintező rendszer (talpak)
 ES Sistema de nivelación de baldosas (clips)

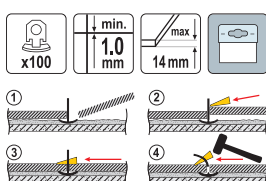

FEATURES:

- Useful when laying tiles on floors and walls
- Work great for large tiles
- Use with tiles of different thickness
- For use with 04718 wedges
- Save time and make work easy and efficient

CECHY:

- Ułatwia układanie płytek na ścianach i podłodze
- Szczególnie przydatny do płytek o większych rozmiarach
- Umożliwia poziomowanie płytek o różnych grubościach
- Do użytku z klinami 04718
- Ułatwia i przyspiesza prace



30x30	33x33	40x40	45x45	50x50	60x60	80x80	60x30	100x50	120x60
42	36	20	28	24	10	10	22	16	10

NUMBER OF CLIPS FOR VARIOUS DIMENSIONS TILES PER 1 M²
 LICZBA KLIPSÓW NA M² W ZALEŻNOŚCI OD ROZMIARU PŁYTKI



No.	pcs / szt.	
04716	100	15

EN Tile leveling system (clips)
 PL System poziomowania płytek (klipsy)
 DE Fliesen Nivelliersystem (Clips)
 RU Система выравнивания плитки (зажимы)
 CS Systém vyrovnávání dlaždic (spony)
 RO Sistem nivelare plăci (cleme)
 HU Csempezintező rendszer (talpak)
 ES Sistema de nivelación de baldosas (clips)

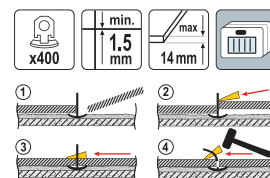

FEATURES:

- Useful when laying tiles on floors and walls
- Work great for large tiles
- Use with tiles of different thickness
- For use with 04718 wedges
- Save time and make work easy and efficient

CECHY:

- Ułatwia układanie płytek na ścianach i podłodze
- Szczególnie przydatny do płytek o większych rozmiarach
- Umożliwia poziomowanie płytek o różnych grubościach
- Do użytku z klinami 04718
- Ułatwia i przyspiesza prace



30x30	33x33	40x40	45x45	50x50	60x60	80x80	60x30	100x50	120x60
42	36	20	28	24	10	10	22	16	10

NUMBER OF CLIPS FOR VARIOUS DIMENSIONS TILES PER 1 M²
 LICZBA KLIPSÓW NA M² W ZALEŻNOŚCI OD ROZMIARU PŁYTKI



No.	pcs / szt.	
04693	400	1

EN Tile leveling system (clips and wedges)
 PL System poziomowania płytek (klipsy i kliny)
 DE Fliesen Nivelliersystem (Clips und Keile)
 RU Система выравнивания плитки (зажимы и клинья)
 CS Systém vyrovnávání dlaždic (spony a klíny)
 RO Sistem nivelare plăci (cleme și pene)
 HU Csempezintező rendszer (talpak és ékek)
 ES Sistema de nivelación de baldosas (clips y cuñas)

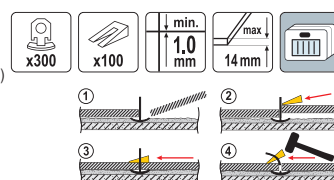

FEATURES:

- Useful when laying tiles on floors and walls
- Work great for large tiles
- Use with tiles of different thickness
- Wedges are reusable
- Save time and make work easy and efficient

CECHY:

- Ułatwia układanie płytek na ścianach i podłodze
- Szczególnie przydatny do płytek o większych rozmiarach
- Umożliwia poziomowanie płytek o różnych grubościach
- Kliny wielokrotnego użytku
- Ułatwia i przyspiesza prace



30x30	33x33	40x40	45x45	50x50	60x60	80x80	60x30	100x50	120x60
42	36	20	28	24	10	10	22	16	10

NUMBER OF CLIPS FOR VARIOUS DIMENSIONS TILES PER 1 M²
 LICZBA KLIPSÓW NA M² W ZALEŻNOŚCI OD ROZMIARU PŁYTKI



No.	pcs / szt.	
04715	300+100	1

EN Tile leveling system (clips)
 PL System poziomowania płytek (klipsy)
 DE Fliesen Nivelliersystem (Clips)
 RU Система выравнивания плитки (зажимы)
 CS Systém vyrovnávání dlaždic (spony)
 RO Sistem nivelare plăci (cleme)
 HU Csempezintező rendszer (talpak)
 ES Sistema de nivelación de baldosas (clips)

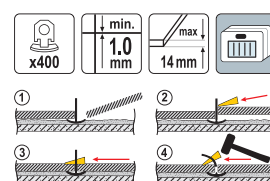

FEATURES:

- Useful when laying tiles on floors and walls
- Work great for large tiles
- Use with tiles of different thickness
- For use with 04718 wedges
- Save time and make work easy and efficient

CECHY:

- Ułatwia układanie płytek na ścianach i podłodze
- Szczególnie przydatny do płytek o większych rozmiarach
- Umożliwia poziomowanie płytek o różnych grubościach
- Do użytku z klinami 04718
- Ułatwia i przyspiesza prace



30x30	33x33	40x40	45x45	50x50	60x60	80x80	60x30	100x50	120x60
42	36	20	28	24	10	10	22	16	10

NUMBER OF CLIPS FOR VARIOUS DIMENSIONS TILES PER 1 M²
 LICZBA KLIPSÓW NA M² W ZALEŻNOŚCI OD ROZMIARU PŁYTKI



No.	pcs / szt.	
04717	400	1

EN Tile leveling system (wedges)
 PL System poziomowania płytek (kliny)
 DE Fliesen Nivelliersystem (Keile)
 RU Система выравнивания плитки (клинья)
 CS Systém vyrovnávání dlaždic (klíny)
 RO Sistem nivelare placi (pene)
 HU Csempeszintező rendszer (ékek)
 ES Sistema de nivelación de baldosas (cuñas)

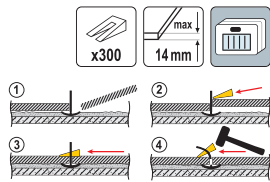

- FEATURES:**
- Useful when laying tiles on floors and walls
 - Work great for large tiles
 - Use with tiles of different thickness
 - Wedges are reusable
 - Save time and make work easy and efficient

- CECHY:**
- Ułatwia układanie płytek na ścianach i podłodze
 - Szczególnie przydatny do płytek o większych rozmiarach
 - Umożliwia poziomowanie płytek o różnych grubościach
 - Kliny wielokrotnego użytku
 - Ułatwia i przyspiesza prace



30x30	33x33	40x40	45x45	50x50	60x60	80x80	60x30	100x50	120x60
42	36	20	28	24	10	10	22	16	10

NUMBER OF CLIPS FOR VARIOUS DIMENSIONS TILES PER 1 M²
 LICZBA KLIPSÓW NA M² W ZALEŻNOŚCI OD ROZMIARU PŁYTKI



No.	pcs / szt.	For / Dla	
04718	300	04690, 04693, 04716, 04717	1

EN Starter kit for levelling ceramic tiles
 PL Zestaw startowy do poziomowania płytek
 DE Startset für Nivellierung der Fliesen
 RU Базовый комплект для выравнивания плитки
 CS Startovací sada pro vyrovnávání dlaždic
 RO Kit pt. nivelat placi ceramice
 HU Csempeszintező kezdőkészlet
 ES Kit inicial de nivelación de azulejos



- FEATURES:**
- Useful when laying tiles on floors and walls
 - Work great for large tiles
 - Use with tiles of different thickness
 - Save time and make work easy and efficient

- CECHY:**
- Ułatwia układanie płytek na ścianach i podłodze
 - Szczególnie przydatny do płytek o większych rozmiarach
 - Umożliwia poziomowanie płytek o różnych grubościach
 - Ułatwia i przyspiesza prace

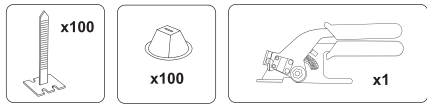

No.	pcs / szt.	
04680	201	6/12

EN Additional tile levelling cups
 PL Kubki dodatkowe do zestawu do poziomowania płytek
 DE Zusätzliche Kappen zum Set für Nivellierung der Fliesen
 RU Дополнительные колпачки для комплекта для выравнивания плитки

CS Dodatkové pohárky k sadě pro vyrovnávání dlaždic
 RO Cupe pt. nivelat placi ceramice
 HU Plusz feltétek csempeszintező készlethez
 ES Cuñas auxiliares para el kit de nivelación de azulejos



No.	pcs / szt.	
04682	100	30

EN Tile leveling system
 PL Klipsy poziomujące płytki
 DE Fliesen-Ausgleichssystem
 RU Система выравнивания плитки-зажим СВП
 CS Dlaždice nivelační systém
 RO Sistemul de nivelare placi
 HU Csempeszintező rendszer
 ES Sistema de nivelación del azulejo



- FEATURES:**
- Useful when laying tiles on floors and walls
 - Work great for large tiles
 - Use with tiles of different thickness
 - Save time and make work easy and efficient

- CECHY:**
- Ułatwiają układanie płytek na ścianach i podłodze
 - Szczególnie przydatne do płytek o większych rozmiarach
 - Umożliwiają poziomowanie płytek o różnych grubościach
 - Ułatwiają i przyspieszają prace

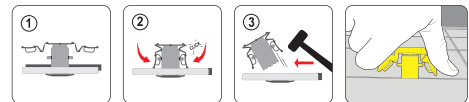

30x30	33x33	40x40	45x45	50x50	60x60	80x80	60x30	100x50	120x60
42	36	20	28	24	10	10	22	16	10

NUMBER OF CLIPS FOR VARIOUS DIMENSIONS TILES PER 1 M²
 LICZBA KLIPSÓW NA M² W ZALEŻNOŚCI OD ROZMIARU PŁYTKI



No.	pcs / szt.	
04677	100	1

EN Additional tile levelling straps
 PL Paski dodatkowe do zestawu do poziomowania płytek
 DE Zusätzliche Stifte zum Set für Nivellierung der Fliesen
 RU Дополнительные полоски для комплекта для выравнивания плитки
 CS Dodatkové pásky k sadě pro vyrovnávání dlaždic
 RO Benzi pt. nivelat placi
 HU Plusz szjzak csempeszintező készlethez
 ES Tiras auxiliares para el kit de nivelación de azulejos

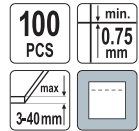

No.	pcs / szt.	
04681	100	18

- EN Additional tile levelling cups and straps
 PL Paski i kubki dodatkowe do zestawu do poziomowania płytek
 DE Zusätzliche Stifte und Kappen zum Set für Nivellierung der Fliesen
 RU Дополнительные полоски и колпачки для комплекта для выравнивания плитки
 CS Dodatečné pásky a pohárky k sadě pro vyrovnání dlaždic
 RO Benzi și cupe pt. nivelat plăci ceramice
 HU Plusz szijak és feltétek csempeszintező készlethez
 ES Tiras y cuñas auxiliares para el kit de nivelación de azulejos



No.	pcs / szt.	
04683	100	24

- EN Cross shape tile spacers
 PL Krzyżyki dystansowe
 DE Fliesenkreuze
 RU Крестики для плитки
 CS Distanční křížky
 RO Distanțiere în cruce
 HU Hézagoló kereszt
 ES Crucetas para juntas



No.	Thickness / Grubość [mm]	pcs / szt.	
04600	1.5	200	100
04610	2.0	200	100
04620	2.5	200	100
04630	3.0	150	100
04640	4.0	100	100
04650	5.0	100	100
04660	6.0	75	100
04668	8.0	30	100
04670	10.0	30	100

- EN Cross shape tile spacers
 PL Krzyżyki dystansowe
 DE Fliesenkreuze
 RU Крестики для плитки
 CS Distanční křížky
 RO Distanțiere în cruce
 HU Hézagoló kereszt
 ES Crucetas para juntas



No.	Thickness / Grubość [mm]	pcs / szt.	
04581	1.0	100	100
04582	1.5	100	100
04583	2.0	100	100
04584	2.5	100	100
04585	3.0	100	100
04586	4.0	75	100

- EN Levelling tongs for precision levelling straps
 PL Szczypce do zaciągania pasków poziomujących
 DE Spannzanze für Nivellierstifte
 RU Шпилцы для затягивания выравнивающих полосок
 CS Kleště do utahování vyrovnávacích pásek
 RO Dispozitiv pt. nivelare
 HU Szintezőszij húzó fogó
 ES Pinzas para tensar tiras de nivelación



No.	
04684	12/48

- EN Wedges for wall and floor tiles
 PL Kliny do glazury
 DE Keile für Wand und Bodenfliesen
 RU Клинья для плитки
 CS Klíny do glazury
 RO Distanțiere faianța
 HU Ék csempéhez
 ES Cuñas para juntas de azulejos



No.	Thickness / Grubość [mm]	pcs / szt.	
04700	4	100	100
04710	7	50	100

- EN Cross shape tile spacers
 PL Krzyżyki dystansowe
 DE Fliesenkreuze
 RU Крестики для плитки
 CS Distanční křížky
 RO Distanțiere în cruce
 HU Hézagoló kereszt
 ES Crucetas para juntas



No.	Thickness / Grubość [mm]	pcs / szt.	
04591	5	50	100
04592	6	50	100
04593	8	30	100
04594	10	30	100

- EN Panel clamps
- PL Klamry do paneli ściennych
- DE Klammern für Paneele
- RU Крепеж для панелей
- CS Přichytky do panelů
- RO Cieme (bride) pt. panouri
- HU Kapcsók c panelekhez
- ES Abrazaderas para paneles de paredes

100
PCS



No.	Type / Typ	pcs / szt.	
04720	C-3	100	50
04721	C-1	100	50

- EN Gas soldering lamp
- CS Plynová pájecí lampa
- PL Gazowa lampa lutownicza
- RO Lampă de lipit pe gaz
- DE Gaslötlampe
- HU Gázos forrasztólámpa
- RU Газовая паяльная лампа
- ES Lampa de gas para soldar

1.7
kW

max °C
1200

123
g/h

PIEZO

BUTANE
BUTAN

METAL BODY
METALOWY KORPUS

190
g



No.	Power / Moc [kW]	
73403	1.7	12

- EN Gas torch
- PL Palnik gazowy
- DE Gasbrenner
- RU Газовая горелка
- CS Plynový hořák
- RO Arzător de gaz
- HU Gázégő
- ES Soplete de gas



0.22
kW

max °C
1300

PIEZO

BUTANE
BUTAN

LIGHTER GAS
GAZ DO ZAPALNICZEK

10
g

LOCK
BLOKADA

CHILDREN PROTECTION
ZABEZPIECZENIE PRZED DZIECIAMI

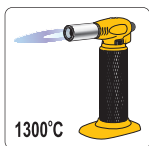
No.	Power / Moc [kW]	
73420	0.22	10/60

- EN Gas soldering lamp
- PL Gazowa lampa lutownicza
- DE Gaslötlampe
- RU Газовая паяльная лампа
- CS Plynová pájecí lampa
- RO Lampă de lipit pe gaz
- HU Gázos forrasztólámpa
- ES Lampa de gas para soldar

1.7
kW

max °C
1200

123
g/h

BUTANE
BUTAN

COMPOSITE BODY
KONPOZYTYWY KORPUS

190
g



No.	Power / Moc [kW]	
73400	1.7	12

- EN Gas soldering lamp
- CS Plynová pájecí lampa
- PL Gazowa lampa lutownicza
- RO Lampă de lipit pe gaz
- DE Gaslötlampe
- HU Gázos forrasztólámpa
- RU Газовая паяльная лампа
- ES Lampa de gas para soldar

1.7
kW

max °C
850

123
g/h

PIEZO

GAS
GAZ

BUTANE
BUTAN

METAL BODY
METALOWY KORPUS

190
g



No.	Power / Moc [kW]	
73404	1.7	20

- EN Soldering tool 3 in 1
- PL Lutownica gazowa 3 w 1
- DE 3 in 1 Gaslötkolben
- RU Газовый паяльник 3 в 1
- CS Plynova rajka 3 v 1
- RO Ciocan de lipit cu gaz 3 in 1
- HU Gaz-forrasztópaka 3 az 1
- ES Soldador de gas 3 en 1

25-80
W

GAS
GAZ

PROPANE
BUTANE
PROPAN
BUTAN

LIGHTER GAS
GAZ DO ZAPALNICZEK

15
ml

60 min

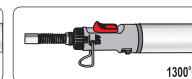
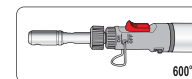
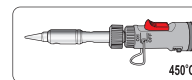
No.	Power / Moc [W]	
73410	25-80	12/48

EN Gas blow torch
 PL Palnik gazowy
 DE Lötbrenner
 RU Газовая горелка
 CS Plynový hořák
 RO Arzător de gaz
 HU Gázégő
 ES Soplete de gas

1.3 kW
 PIEZO
 max °C 1300
 GAS GAZ
 BUTANE BUTAN



No.	Power / Moc [kW]	
73412	1.3	10/60

EN Plumbers torch set with burners
 PL Zestaw do lutowania z dyszami
 DE Lötsetz
 RU Набор для пайки
 CS Souprava k letování
 RO Set pt. lipit
 HU Forrasztó készlet
 ES Juego para soldadura

0.4 MPa (max.)
 BUTANE BUTAN
 290 g/h
 4.0 kW
 800-1200 °C
 360 mm
 x3
 17/22/40 mm
 2 m



No.	Max. pressure / Maks. ciśnienie [MPa]	Power / Moc [kW]	L [mm]	
73325	0.4	4	360	20

EN Flat nozzle
 PL Dysza do lutowania, płomień płaski
 DE Düse zum Löten, flache Flamme
 RU Сопло плоское
 CS Dýza na letování, plochý plamen
 RO Duză pt. lipit, flacăra plată
 HU Bádógos forrasztó készülék
 ES Tobera para soldadura, llama plana

40 mm



No.	Size / Rozmiar [mm]	
73331	40	50/250

EN Roof heating torch with burners
 PL Palnik dekarSKI z dyszami i lancia
 DE Dachdeckerbrenner
 RU Кровельная горелка
 CS Hořák pro pokrýváče
 RO Arzător pt. acoperiș
 HU Bádógos forrasztó készülék
 ES Soplete de techado

0.4 MPa (max.)
 BUTANE BUTAN
 3420 g/h
 47 kW
 1500-1800 °C
 745 mm
 x1
 50 mm
 2 m



No.	Max. pressure / Maks. ciśnienie [MPa]	Power / Moc [kW]	L [mm]	
73341	0.4	47	745	20

EN Gas blow torch
 PL Palnik gazowy
 DE Lötbrenner
 RU Газовая горелка
 CS Plynový hořák
 RO Arzător de gaz
 HU Gázégő
 ES Soplete de gas

1.3 kW
 PIEZO
 max °C 1300
 GAS GAZ
 BUTANE BUTAN



No.	Power / Moc [kW]	
73413	1.3	10/60

EN Point nozzle
 PL Dysza do lutowania, płomień punktowy
 DE Düse zum Löten, Punktflamme
 RU Сопло паяльника
 CS Dýza na letování, bodový plamen
 RO Duză pt. lipit, flacăra punct
 HU Forrasztó égő, szűró láng
 ES Tobera para soldadura, llama de punta

17 mm



No.	Size / Rozmiar [mm]	
73330	17	50/250

EN Roof heating torch with burners
 PL Palnik dekarSKI z dyszami
 DE Dachdeckerbrenner
 RU Кровельная горелка
 CS Hořák pro pokrýváče
 RO Arzător pt. acoperiș
 HU Bádógos forrasztó készülék
 ES Soplete de techado

0.4 MPa (max.)
 BUTANE BUTAN
 930 g/h
 13 kW
 1500-1800 °C
 360 mm
 x3
 25/35/50 mm
 2 m



No.	Max. pressure / Maks. ciśnienie [MPa]	Power / Moc [kW]	L [mm]	
73340	0.4	13	360	10

EN Roof heating torch with burners
 PL Palnik dekarski z dyszami i lanca
 DE Dachdeckerbrenner
 RU Кровельная горелка
 CS Hořák pro pokrývače
 RO Arzător pt. acoperiș
 HU Bádógos forrasztó készülék
 ES Soplete de techado

0.25 MPa (max.)	BUTANE BUTAN	4465 g/h	62 kW	800-1200 °C
1315 mm	x1	60mm	5m	



No.	Max. pressure / Maks. ciśnienie [MPa]	Power / Moc [kW]	L [mm]	
73342	0.25	62	1315	8

EN Weed burner
 PL Palnik do wypalania chwastów
 DE Unkrautbrenner
 RU Горелка для выжигания сорняков
 CS Hořák na plevel
 RO Arzător pt. buruieni
 HU Gyomégető
 ES Quemador de malezas

PIEZO	PROPANE BUTANE PROPAN BUTAN	226 g/h	3 kW	max °C 1300
7/16" 11mm	850 mm	x1	25mm	



No.	Power / Moc [kW]	L [mm]	
73430	3	850	12

EN Nozzle
 PL Dysza
 DE Düse
 RU Сопло
 CS Dýza
 RO Duză
 HU Fúvóka
 ES Tobera



No.	Ø [mm]	
73350	25	50
73351	35	50
73352	50	50
73353	60	50

EN Hose
 PL Wąż przyłączeniowy do gazu
 DE Anschluss Schlauch für Gas
 RU Шланг газопроводящий

CS Hadice k připojení plynu
 RO Furtun de conectare pt. gaz
 HU Csatlakozó gáztömlő
 ES Manguera de conexión de gas

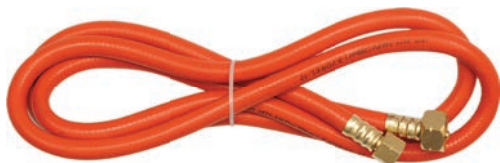

No.	L [m]	Ø [mm]	
73360	2	8	20
73362	5	8	10

EN Roof heating torch with burners
 PL Palnik dekarski z dyszami i lanca
 DE Dachdeckerbrenner
 RU Кровельная горелка
 CS Hořák pro pokrývače
 RO Arzător pt. acoperiș
 HU Bádógos forrasztó készülék
 ES Soplete de techado

0.25 MPa (max.)	BUTANE BUTAN	5900 g/h	82 kW	1500-1800 °C
1385 mm	x2	60mm	5m	



No.	Max. pressure / Maks. ciśnienie [MPa]	Power / Moc [kW]	L [mm]	
73343	0.25	82	1385	8

EN Aluminium telescopic ladder
 PL Aluminiowa drabina teleskopowa
 DE Teleskopleiter aus Aluminium
 RU Многофункциональная стремянка
 CS Hliníkový teleskopický žebřík
 RO Scară telescopică din aluminiu
 HU Alumínium kihúzóható létra
 ES Escalera telescópica de aluminio

max 3.8 m	13 STEPS STOPNIE	max 150 kg
AI	NYLON	

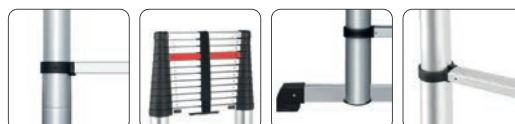
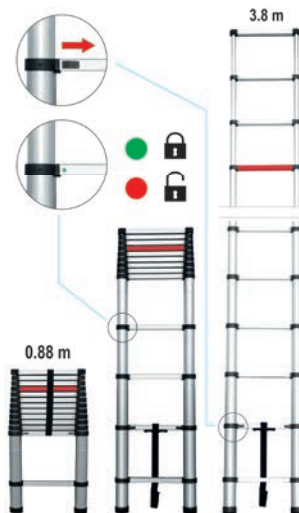

No.	Max. height / Maks. wysokość [m]	Rung quantity / Liczba stopni	
17701	3.8	13	1

EN Aluminium telescopic ladder
 PL Aluminiowa drabina teleskopowa
 DE Teleskopleiter aus Aluminium
 RU Многофункциональная стремянка
 CS Hliníkový teleskopický žebřík
 RO Scară telesopică din aluminiu
 HU Alumínium kihúzóható létra
 ES Escalera telescópica de aluminio

max 3.8 m
 13 STEPS / STOPNIE
 max 150 kg
 AI NYLON

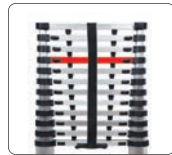

No.	Max. height / Maks. wysokość [m]	Rung quantity / Liczba stopni	
17702	3.8	13	1

EN 2-step ladder
 PL Drabina 2-stopniowa rozkładana
 DE 2-Stufen-Leiter
 RU 2-ступенчатая лестница
 CS Schůdky 2 stupně
 RO Scări cu 2 trepte
 HU 2 fokos lépcsők
 ES 2 pasos escaleras

90x47.5 x49 cm
 h 99 cm FOLDED / ZŁOŻONA
 2 STEPS / STOPNIE
 38x26 cm
 max 150 kg
 SOFT GRIP / MIEKKI UCWYTY
 PROTECTION RAIL / WSPORNIK OCHRONNY



No.	Height / Wysokość [m]	Rung quantity / Liczba stopni	
17730	0.9	2	4

EN Multifold ladder
 PL Drabina wielofunkcyjna
 DE Mehrzweckleiter
 RU Лестница многофункциональная
 CS Multifunkční žebřík
 RO Scară multifuncțională
 HU Többcélú létra
 ES Escalera multipropósito

max 3.4 m
 4x3 STEPS / STOPNIE
 16 kg
 max 150 kg

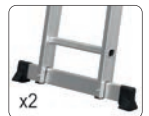
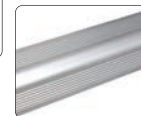

No.	Max. height / Maks. wysokość [m]	Rung quantity / Liczba stopni	
17704	3.4	4x3	1

EN 3-step ladder
 PL Drabina 3-stopniowa rozkładana
 DE 3-Stufen-Leiter
 RU 3-ступенчатая лестница
 CS Schůdky 3 stupně
 RO Scări cu 3 trepte
 HU 3 fokos lépcsők
 ES 3 pasos escaleras

115x47.5 x65 cm
 h 125 cm FOLDED / ZŁOŻONA
 3 STEPS / STOPNIE
 38x26 cm
 max 150 kg
 SOFT GRIP / MIEKKI UCWYTY
 PROTECTION RAIL / WSPORNIK OCHRONNY



No.	Height / Wysokość [m]	Rung quantity / Liczba stopni	
17733	1.15	3	2

- EN Multifold ladder platform
- PL Podest do drabiny wielofunkcyjnej
- DE Podest für die Multifunktionale Leiter
- RU Подставки для стремянки
- CS Plošina pro víceúčelový žebřík
- RO Platformă pt. scară multifuncțională
- HU Palló a multifunkciós létrához
- ES Descansillos para la escala multifuncional

830x295 mm	560x295 mm	ZINC PLATED OCYNKO- WANA
	max 150 kg	

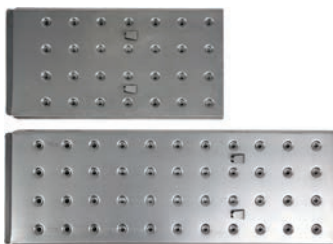

No.	For / Dla	
17705	17704	5

- EN Saw horse
- PL Podstawa robocza z metalu
- DE Stahl-Arbeitsbock
- RU Опорный штатив
- CS Opěrný kožík
- RO Capre de lucru
- HU Munkabak
- ES Caballete de apoyo

2 PCS	100x10 x75 cm	max 200 kg	NON SLIP WORKTOP BLAT ANTY- POŚLIZGOWY



No.	
29401	1

- EN Adjustable roller stand
- PL Podpora z rolką
- DE Rollenbock
- RU Роликовая опора
- CS Opěrný stojan
- RO Stand cu role si suport
- HU Felsőgörgős-bak
- ES Caballete de apoyo con rodillo

105 68 mm	60cm ROLLER ROLKA	max 60 kg



No.	
29410	1

- EN Saw horse
- PL Podstawa robocza z tworzywa
- DE Stahl-Arbeitsbock
- RU Опорный штатив
- CS Opěrný kožík
- RO Capre de lucru
- HU Munkabak
- ES Caballete de apoyo

2 PCS	PP	ABS	TPR	
----------	----	-----	-----	--



No.	
29400	3

- EN Saw horse
- PL Podstawa robocza z regulowaną wysokością
- DE Stahl-Arbeitsbock
- RU Опорный штатив
- CS Opěrný kožík
- RO Capre de lucru
- HU Munkabak
- ES Caballete de apoyo

130 79 mm	max 200 kg	GALVANIZED STEEL OCYNKOWANA	HOLDER FOR CARRYING UCHWYT DO PRZENOSZENIA	
-----------------	---------------	-----------------------------------	---	--



No.	
29404	1

- EN Telescopic support bar
- PL Podpora teleskopowa
- DE Baustütze-Schnellspannstütze
- RU Подъемник-распорка для гипсокартона
- CS Tuč teleskopická rozpěrná
- RO Suport sustinere telescopic
- HU Teleszkópos támasztórúd
- ES Puntal expansion

115 50 cm	max 30 kg	
-----------------	--------------	--



No.	
29440	2/10

EN Telescopic support bar
 PL Podpora teleskopowa
 DE Baustütze-Schnellspannstütze
 RU Подъемник-распорка для гипсокартона
 CS Tuč teleskopická rozpěrná
 RO Suport sustinere telescopic
 HU Teleszkópos támasztórúd
 ES Puntal expansion



No.	
29444	2/10

EN Polystyrene plastering trowel
 PL Paca styropianowa
 DE Styropor-Reibebrett
 RU Тёрка пенопластовая
 CS Polystyrénové hladítko
 RO Gletiera poliuretan
 HU Habszivacs símitó
 ES Liana de polietileno



No.	Size / Rozmiar [mm]	
06400	130x270	10
06410	140x500	10
06440	170x320	10

EN Polystyrene plastering trowel
 PL Paca styropianowa
 DE Styropor-Reibebrett
 RU Тёрка пенопластовая
 CS Polystyrénové hladítko
 RO Gletiera poliuretan
 HU Habszivacs símitó
 ES Liana de polietileno

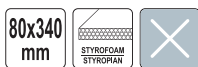

No.	Size / Rozmiar [mm]	
06401	80x340	10

EN Telescopic support bar
 PL Podpora teleskopowa
 DE Baustütze-Schnellspannstütze
 RU Подъемник-распорка для гипсокартона
 CS Tuč teleskopická rozpěrná
 RO Suport sustinere telescopic
 HU Teleszkópos támasztórúd
 ES Puntal expansion



No.	
29445	8

EN Polystyrene plastering trowel
 PL Paca styropianowa
 DE Styropor-Reibebrett
 RU Тёрка пенопластовая
 CS Polystyrénové hladítko
 RO Gletiera poliuretan
 HU Habszivacs símitó
 ES Liana de polietileno



No.	Size / Rozmiar [mm]	
06420	140x700	10
06430	140x1000	10

EN Steel plastering trowel
 PL Tarka do styropianu
 DE Reibebrett für Styropor
 RU Тёрка стальная нержавеющая
 CS Ohnutá šprachtle nerezavějící
 RO Gletiera oțel
 HU Spatula hajlított, rozsdamentes
 ES Espatula de acero inox curvo



No.	Size / Rozmiar [mm]	
06470	270x130	20
06472	400x180	10

EN Plastic plastering trowel
 PL Paca tynkarska plastikowa
 DE Glättekelle
 RU Гладилка пластиковая
 CS Umělohmotné hladítko omítkářské
 RO Gletiera PVC
 HU Műanyag símitó vakoláshoz
 ES Llana de plástico para enlucido

270x130
mm



No.	Size / Rozmiar [mm]	
06500	270x130	24

EN Soft rubber plastering trowel
 PL Paca tynkarska miękka guma
 DE Gummireibebrett
 RU Терка пластмассовая с резиновым покрытием
 CS Umělohmotné hladítko omítkářské z měkkou gumou
 RO Gletiera PVC cu cauciuc
 HU Műanyag símitó vakoláshoz, lágy gumival
 ES Llana de plástico para enlucido con goma suave

270x130
mm



VOREL

No.	Size / Rozmiar [mm]	Rubber thickness / Grubość gumy [mm]	
06520	270x130	4	30

EN Plastering trowel
 PL Paca tynkarska rzadka gąbka
 DE Schwambrett
 RU Терка штукатурная с поролоновым покрытием (пластмассовая)
 CS Umělohmotné hladítko omítkářské z řídkou houbou
 RO Gletiera PVC cu burete rar
 HU Műanyag símitó vakoláshoz, lágy szivaccsal
 ES Llana de plástico para enlucido con esponja poco densa

270x130
mm



VOREL

No.	Size / Rozmiar [mm]	Sponge thickness / Grubość gąbki [mm]	
06540	270x130	25	20

EN Stainless steel plastering trowel
 PL Paca tynkarska metalowa nierdzewna
 DE Schweizer Glätte gezahnt
 RU Гладилка металлическая зубчатая

CS Hladítko omítkářské nerezavějící
 RO Gletiera inox
 HU Rozsdamentes símitó vakoláshoz
 ES Llana para enlucido acero inox. llano

SS
STAINLESS STEEL
STAL NIERDZEWNA



VOREL

No.	Size / Rozmiar [mm]	Teeth size / Rozmiar zębów [mm]	
06650	380x128	8x8	10
06670	480x128	8x8	10
06690	580x128	8x8	18

EN Plastering trowel
 PL Paca tynkarska filc
 DE Filzglätter
 RU Терка пластмассовая с войлочным покрытием
 CS Umělohmotné hladítko omítkářské z filcem
 RO Gletiera PVC cu pasla
 HU Műanyag símitó vakoláshoz, filccel
 ES Llana de plástico para enlucido con fieltro

270x130
mm



VOREL

No.	Size / Rozmiar [mm]	
06510	270x130	20

EN Plastering trowel
 PL Paca tynkarska gęsta gąbka
 DE Schwambrett
 RU Терка штукатурная с поролоновым покрытием (пластмассовая)
 CS Umělohmotné hladítko omítkářské z hustou houbou
 RO Gletiera PVC cu burete dens
 HU Műanyag símitó vakoláshoz, tömör szivaccsal
 ES Llana de plástico para enlucido con esponja densa

270x130
mm



VOREL

No.	Size / Rozmiar [mm]	Sponge thickness / Grubość gąbki [mm]	
06530	270x130	25	20

EN Stainless steel plastering trowel
 PL Paca tynkarska metalowa nierdzewna
 DE Schweizer Glätte
 RU Гладилка нержавеющей гладкая
 CS Hladítko omítkářské nerezavějící
 RO Gletiera inox
 HU Rozsdamentes símitó vakoláshoz
 ES Llana para enlucido acero inox. llano

SS
STAINLESS STEEL
STAL NIERDZEWNA



VOREL

No.	Size / Rozmiar [mm]	
06640	380x128	10
06660	480x128	10
06680	580x128	18

EN Stainless steel plastering trowel
 PL Paca tynkarska metalowa nierdzewna
 DE Glättekelle
 RU Гладилка нержавеющей с пластмассовой ручкой
 CS Hladítko omítkářské nerezavějící
 RO Gletiera inox maner plastic
 HU Rozsdamentes símitó vakoláshoz
 ES Llana de enlucido de acero inoxidable

SS
STAINLESS STEEL
STAL NIERDZEWNA



VOREL

No.	Size / Rozmiar [mm]	
06700	270x125	24

EN Stainless steel plastering trowel
 PL Paca tynkarska metalowa nierdzewna, podstawa aluminium
 DE Glättekelle
 RU Гладилка стальная нержавеющая гладкая
 CS Hladitko omltkáfské nerezavějící
 RO Gletiera inox
 HU Rozsdamentes simító vakoláshoz
 ES Llana de enlucido de acero inoxidable



VOREL

No.	Size / Rozmiar [mm]	
06701	270x130	24

EN Float with soft rubber
 PL Paca miękka z gumą do fugowania
 DE Weiches Reibebrett mit Gummi zum Verfugen
 RU Терка для затирки швов
 CS Hladitko měkké s gumou na spárování
 RO Pac moale cu cauciuc pt. cimentare
 HU Fugázó simító puha gumival
 ES Llana suave con goma para rejuntar



VOREL

No.	Size / Rozmiar [mm]	
06512	260x95	12

EN Plastic float with hydrorubber
 PL Paca plastikowa z hydrogumą
 DE Reibebrett aus Kunststoff, mit Hydrogummi
 RU Терка шлифовальная с мягкой зубчатой накладкой
 CS Plastové hladitko s rěnovou gumou
 RO Netezitoare din plastic cu hidrocauciuc
 HU Műanyag simító, durva szivacsos
 ES Llana de plástico con hidrocaucho



VOREL

No.	Size / Rozmiar [mm]	Rubber thickness / Grubość gumy [mm]	
06537	270x130	9	20
06538	270x130	18	20

EN Stainless steel brick trowel
 PL Kielnia trójkątna nierdzewna
 DE Spitzkelle
 RU Кельма треугольная нержавеющая
 CS Zednická lžice trojúhelníková nerezavějící
 RO Mistrie triunghiulară inoxidabilă
 HU Háromszög vakolókanál, rozsdamentes
 ES Paleta triangular de acero inox.



VOREL

No.	Size / Rozmiar [mm]	
06341	180	50
06351	200	30

EN Stainless steel plastering trowel
 PL Paca tynkarska metalowa nierdzewna
 DE Glättekelle gezahnt
 RU Гладилка нержавеющая зубчатая

CS Hladitko omltkáfské nerezavějící
 RO Gletiera inox
 HU Rozsdamentes simító vakoláshoz
 ES Llana para enlucido de acero inox. llano



VOREL

No.	Size / Rozmiar [mm]	Teeth size / Rozmiar zębów [mm]	
06740	270x125	4x4	24
06760	270x125	6x6	24
06780	270x125	8x8	24
06781	270x125	10x10	24

EN Plastic float with incised sponge
 PL Paca plastikowa z gąbką nacinaną
 DE Reibebrett aus Kunststoff, mit aufgeschnittenem Schwamm
 RU Пластиковый шпатель с надрезной губкой
 CS Plastové hladitko s nařezanou houbou
 RO Netezitoare din plastic cu burete tăiat
 HU Műanyag simító, szivacsos
 ES Llana de plástico con esponja entallada



VOREL

No.	Size / Rozmiar [mm]	Sponge thickness / Grubość gąbki [mm]	
06532	270x130	30	20

EN Brick trowel
 PL Kielnia trójkątna
 DE Spitzkelle
 RU Кельма треугольная
 CS Zednická lžice trojúhelníková
 RO Mistrie triunghiulară
 HU Háromszög vakolókanál
 ES Paleta triangular



VOREL

No.	Size / Rozmiar [mm]	
06340	180	50
06350	200	50
06360	220	50

EN Stainless steel brick trowel
 PL Kielnia trapezowa nierdzewna
 DE Stukkaturkelle
 RU Кельма шпательная нержавеющая
 CS Lichoběžníková zednická lžice nerezavějící
 RO Mistrie trapezoidală inoxidabilă
 HU Trapéz vakolókanál, rozsdamentes
 ES Paleta trapezoidal de acero inox.



VOREL

No.	Size / Rozmiar [mm]	
06370	130	50
06380	180	30

- EN Stainless steel scraper
- PL Kielnia szturopłatkowa, podkowa
- DE Stukkateurspachtel
- RU Кельма штукатурная
- CS Ohnutá špachtle nerezavějící
- RO Șpaclu indoit inoxidabil
- HU Spátula hajlított, rozsdamentes
- ES Espátula de acero inox curvo



No.	Size / Rozmiar [mm]	
06109	40x110	50
06110	60x110	50
06120	80x120	50
06121	100x120	50

- EN Ceiling plaster / stucco spray gun
- PL Tynkownica pneumatyczna do sufitów
- DE Deckenplatte / Stucco Spritzpistole
- RU Пневмоковш для штукатурки потолков
- CS Stříkací pistole pro maltu
- RO Spray pistol pt. mortar
- HU Habarcs szórópisztoly
- ES Pistola pulverizadora para mortero

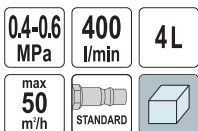

$L_{pa} = 94,9 \pm 2,5$ dB; $L_{wa} = 105,9 \pm 2,5$ dB; $a_n = <2,5$ m/s²

No.	Required air flow / Wymagany przepływ powietrza [l/min]	
09903	350-400	4

- EN Trowel for aerated blocks
- PL Kielnia do betonu komórkowego
- DE Kelle für Porenbeton
- RU Кельма для газобетона
- CS Zednická ližce na pórobeton
- RO Mistrie pt. bca
- HU Habarcszterítő kanál sejtbetonhoz
- ES Allanadora para hormigón celular



No.	Size / Rozmiar [mm]	
05801	100	10
05802	115	10
05803	125	10
05804	200	10
05805	240	10
05806	300	10
05807	365	10

- EN Plaster / stucco spray gun
- PL Tynkownica pneumatyczna do ścian
- DE Spritzpistole für Mörtel
- RU Пневмоковш для штукатурки стен
- CS Stříkací pistole pro maltu
- RO Spray pistol pt. mortar
- HU Habarcs szórópisztoly
- ES Pistola pulverizadora para mortero

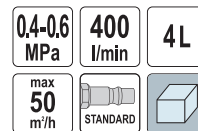

$L_{pa} = 91,8 \pm 2,5$ dB; $L_{wa} = 102,8 \pm 2,5$ dB; $a_n = <2,5$ m/s²

No.	Required air flow / Wymagany przepływ powietrza [l/min]	
09900	350-400	4

- EN Hand wall coating sprayer
- PL Narzędzie tynku
- DE Verputzmaschine
- RU Метатель штукатурки
- CS Omítacka
- RO Pulverizator manual pt. pereti
- HU Vakolatszóró
- ES Máquina de revestimiento de yeso



No.	Size / Rozmiar [mm]	
09910	210x170	12

- EN Borer for aerated blocks
- PL Wiertło do bloczków
- DE Bohrer für Porenbeton
- RU Сверло по газобетону
- CS Vrták do kvádrů
- RO Șfredel pt. bca
- HU Falfúró
- ES Taladro para bloques



No.	Working width / Szerokość robocza [mm]	
05821	60	20
05822	80	20
05823	120	20

EN Scraper for plaster and aerated blocks
 PL Zdzierak wyrównujący
 DE Gipsobel mit Stahlklingen
 RU Рубанок для газобетона
 CS Vyrovňovací škrabák
 RO Rașpel de nivelare
 HU Kiegyenlítő dörzsölő
 ES Raspador

80x400 mm



No.	Size / Rozmiar [mm]	
05830	80x400	10

EN Template tool for aerated blocks cut
 PL Przyrząd do cięcia pod kątem
 DE Werkzeug für Porenbeton schneiden
 RU Угольник для резки газобетона
 CS Pravitko k řezání pod úhlem
 RO Dispozitiv pt. taiat bca
 HU Gérvágó tok
 ES Calibre de comprobación para cortes angulares



No.		
05840		4

EN Steel drywall board lifter
 PL Stalowa dźwignia do unoszenia płyt
 DE Stahlheber zum Anheben der Platten
 RU Ножной рычаг для подъема листовых материалов
 CS Ocelový pažní zvedák na desky
 RO Dispozitiv ridicare placii rigips
 HU Acél kar a lapok felemeléséhez
 ES Palanca de acero para la elevación de placas

STEEL STAL



No.		
04750		6/24

EN Panel carry
 PL Nosidło do płyt gipsowo-kartonowych
 DE Plattenträger mit Tragegriff
 RU Приспособление для переноски плит
 CS Držák pro přenášení desek s rukojetí
 RO Dispozitiv pt. transportat plac de gips-carton
 HU Gipszkarton hordó
 ES Porta-paneles

560x140 x190 mm



No.	Dimensions / Wymiary [mm]	
04756	560x140x190	10

EN Scraper with teeth for plaster and aerated blocks
 PL Zdzierak wyrównujący z ząbkami
 DE Gipsobel mit Stahlklingen gezahnt
 RU Рубанок для газобетона зубчатый
 CS Vyrovňovací škrabák se zoubky
 RO Rașpel cu dinți
 HU Fogas, kiegyenlítő dörzsölő
 ES Raspador con dientes

80x400 mm



No.	Size / Rozmiar [mm]	
05831	80x400	10

EN Grooving device for aerated concrete
 PL Rylec do betonu komórkowego
 DE Werkzeug für Porenbeton bohrung
 RU Штроборез по газобетону
 CS Drážkovač na pórobeton
 RO Dispozitiv canelat bca
 HU Horonymaró sejtetonhoz
 ES Cíncel para hormigón celular



No.		
05850		10

EN Drywall panel carrier
 PL Uchwyt do przenoszenia płyt gipsowo-kartonowych
 DE Plattenträger mit Tragegriff
 RU Приспособление для переноски плит
 CS Držák pro přenášení desek s rukojetí
 RO Dispozitiv pt. transportat plac de gips-carton
 HU Jellemzők és előnyök
 ES Empunadura porta-placas

2 PCS

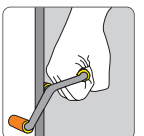

No.		
04755		6/12

EN Drywall stripper
 PL Obcinak dwustronny do płyt gipsowo-kartonowych
 DE Streifen Schneider
 RU Рейсмус-резаk для гипсокартона
 CS Rezák na sádkarton
 RO Dispozitiv reglabil de taiere a placilor de gips-carton
 HU Gipszkarton-vágó
 ES Cortador de tiras para tablaroca

20-500 mm

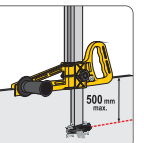

No.	Cutting width / Szerokość cięcia [mm]	
04770	20-500	10

- EN Saw for gas concrete
- PL Pila do gazobetonu
- DE Gasbetonsäge
- RU Пила по газобетону с твердосплавным зубом
- CS Pila na plynobeton
- RO Fierastrau cu placute vidia pt. BCA
- HU Fűrész gázbetonhoz
- ES Sierra para gas hormigon



No.	L [mm]	T	
28000	600	33	5
28010	600	17	5

- EN Saw for gas concrete
- PL Pila do gazobetonu
- DE Gasbetonsäge
- RU Пила по газобетону с твердосплавным зубом
- CS Pila na plynobeton
- RO Fierastrau cu placute vidia pt. BCA
- HU Fűrész gázbetonhoz
- ES Sierra para gas hormigon



No.	L [mm]	T	
28011	600	15	6/12
28012	660	34	6/12

11

- EN Scraper set
- PL Komplet szpachelek
- DE Malerspachtelsetz
- RU Набор шпателей
- CS Špachtle
- RO Șpacluri
- HU Spátula
- ES Espátulas



No.	Working width / Szerokość robocza [mm]	pcs / szt.	
06130	30, 50, 80	3	25/100

- EN Plastic japanese putty knife
- PL Szpachle japońskie plastikowe
- DE Japanspachtelsetz Kunststoff
- RU Пластиковые шпатели „ЯПОНКИ”
- CS Japonské špachtle
- RO Set șpacluri plastic
- HU Spakli készlet
- ES Triuso espátula japonesa

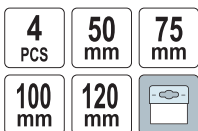

No.	Working width / Szerokość robocza [mm]	pcs / szt.	
05950	50, 80, 100, 120	4	10

- EN Scraper
- PL Szpachelka
- DE Malerspachtel
- RU Шпатель
- RO Șpachtle
- RU Șpaclu
- RU Spatula
- ES Espátula



No.	Working width / Szerokość robocza [mm]	
06030	30	12/240
06040	40	12/240
06050	50	12/240
06060	60	12/240
06080	80	12/240
06100	100	12/240

- EN Stainless steel scraper
- PL Szpachelka kątowa wewnętrzna
- DE Kelle für Innenecken
- RU Кельма для внутренних углов
- CS Úhlová špachtle vnitřní
- RO Șpaclu unghiular interior
- HU Belsőél kanál
- ES Paleta en angulo



No.	Dimensions / Wymiary [mm]	
06150	80x60x60	50

- EN Stainless steel scraper set
- PL Szpachelki nierdzewne „japonki”
- DE Aufstreichspachtel
- RU Набор шпателей тип „Японский”
- CS Špachtle japonské nerezavějící
- RO Șpacluri japoneze inoxidabile
- HU Spátula rozsdamentes
- ES Espátulas „japonesas” de acero

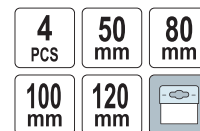

No.	Working width / Szerokość robocza [mm]	pcs / szt.	
06290	50, 80, 100, 120	4	12/120

EN Stainless steel putty knife
 PL Szpachla malarska nierdzewna
 DE Glasurzange
 RU Шпатель фасадный
 CS Maliřská špachtle nerezavějící
 RO Spaclu de chituit, inox, maner plastic
 HU Rozsdamentes festőspatula
 ES Espátula de pintura, de acero inox



No.	Working width / Szerokość robocza [mm]	
06294	40	100
06295	60	80
06296	80	60
06297	100	50
06298	150	80
06301	200	60
06304	250	50
06307	350	25
06308	450	25
06309	600	10

EN Plastic putty knives for glue
 PL Pace plastikowe do kleju
 DE Kunststoffspachtel gezahnt
 RU Пластиковые шпатели для плиточного клея
 CS Zubová stěrka plastová
 RO Spatula zimtata
 HU Műanyag spakli
 ES Espátula de plástico

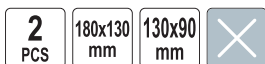

VOREL

No.	Dimensions / Wymiary [mm]	pcs / szt.	
05960	180x130, 130x90	2	10

EN Plastic putty knife with teeth
 PL Szpachla plastikowa z zębami
 DE Spachtel Kunststoff
 RU Шпатель пластмассовый, зубчатый
 CS Plastové čtyřhranné zuby
 RO Spatula dintata
 HU Fogazott műanyag spatulya
 ES Espátula de plástico con dientes



VOREL

No.	Working width / Szerokość robocza [mm]	Teeth size / Rozmiar zębów [mm]	
05972	225	6x6	50

EN Plastic putty knife set
 PL Zestaw szpachli plastikowych
 DE Kunststoffspatel
 RU Шпатели пластиковые
 CS Sada univerzálních stěrky
 RO Set spaclu plastic
 HU Spakli készlet
 ES Set espátula de plástico

VOREL

No.	Working width / Szerokość robocza [mm]	pcs / szt.	
05980	40, 60, 80, 100	4	30

EN Stainless steel putty knife
 PL Szpachla nierdzewna
 DE Kleberspachtel
 RU Шпатель фасадный зубчатый
 CS Špachtle nerezavějící
 RO Spaclu de chituit, inox, maner plastic, crestat
 HU Rozsdamentes spatula
 ES Espátula de acero inox.



No.	Working width / Szerokość robocza [mm]	Teeth size / Rozmiar zębów [mm]	
06299	150	6x6	80
06300	150	8x8	80
06302	200	6x6	60
06303	200	8x8	60
06305	250	6x6	50
06306	250	8x8	50

EN Plastic smooth putty knife
 PL Szpachla plastikowa gładka
 DE Spachtel Kunststoff
 RU Шпатель прямой пластмассовый
 CS Plastové rovné
 RO Spatula dintata
 HU Műanyag spakli
 ES Espátula de plástico



VOREL

No.	Working width / Szerokość robocza [mm]	
05971	225	50

EN Plastic putty knife with truncated teeth
 PL Szpachla plastikowa z zębami trójkątnymi
 DE Spachtel Kunststoff
 RU Шпатель пластмассовый, зубчатый
 CS Plastové trojúhelníkové zuby
 RO Spatula dintata
 HU Fogazott műanyag spatulya
 ES Espátula de plástico con dientes



VOREL

No.	Working width / Szerokość robocza [mm]	Teeth size / Rozmiar zębów [mm]	
05973	225	7	50



- EN Rubber grout spreader
- PL Szpachla gumowa do fugowania
- DE Gummispachtel
- RU Шпатель резиновый для фуговки
- CS Pryžová špachtle na fugování
- RO Spaclu cauciucat pt. rosturi
- HU Fugázógumi
- ES Espátula de goma para rejuntar



No.	Working width / Szerokość robocza [mm]	
06310	150	30
06320	200	30
06330	250	30
06331	300	30

- EN Stainless steel scraper
- PL Szpachelka nierdzewna
- DE Rostfrei Spachtel
- RU Шпатель нержавеющей
- CS Špachtle
- RO Șpaclu
- HU Spatula
- ES Espatula de acero inox



No.	Working width / Szerokość robocza [mm]	
05901	30	6/72
05902	40	6/72
05903	50	6/72
05904	60	6/72
05905	80	6/72
05906	100	6/72

- EN Stainless steel scraper
- PL Szpachelka nierdzewna
- DE Rostfrei Spachtel
- RU Шпатель нержавеющей изогнутый
- CS Špachtle
- RO Șpaclu
- HU Spatula
- ES Espatula de acero inox



No.	Working width / Szerokość robocza [mm]	
05911	30	6/72
05912	40	6/72
05913	50	6/72
05914	60	6/72
05915	80	6/72
05916	100	6/72

- EN Painting scraper
- PL Skrobak malarski
- DE Malerabkratzer
- RU Скребок для краски со сменным лезвием
- CS Škrabka malářská
- RO Răzuitor pt. zugrăvi
- HU Festékvakaró
- ES Rascador de pintor



No.	Blade working width / Szerokość robocza ostrza [mm]	
06795	100	60

- EN Flexible silicone and sealant smother
- PL Gładzik do silikonu
- DE Silikonglätter
- RU Шпатель для затирки силикона
- CS Hladtko do silikonu
- RO Dispozitiv pt. silicon si mastic
- HU Szilikon lehűző
- ES Alisador de juntas de silicona



No.	L [mm]	
04360	150	24/240



- EN Stainless steel scraper
- PL Szpachelka nierdzewna wygięta
- DE Rostfrei Spachtel
- RU Шпатель нержавеющей изогнутый
- CS Špachtle
- RO Șpaclu
- HU Spatula
- ES Espatula de acero inox curvo



No.	Working width / Szerokość robocza [mm]	
05921	30	6/72
05922	40	6/72
05923	50	6/72
05924	60	6/72
05925	80	6/72
05926	100	6/72

- EN Painting scraper
- PL Skrobak malarski
- DE Malerabkratzer
- RU Скребок для краски со сменным лезвием
- CS Škrabka malářská
- RO Răzuitor pt. zugrăvi
- HU Festékvakaró
- ES Rascador de pintor



No.	Working width / Szerokość robocza [mm]	
06797	115	50

EN Spare blades for painting scraper
 PL Ostrze do skrobaka
 DE Schneide für Malerabkratzer
 RU Сменные лезвия для скребка
 CS Ostří do škrabky
 RO Taiși pt. răzuitor
 HU Fesztékvakaró-pengék
 ES Filo para rascador

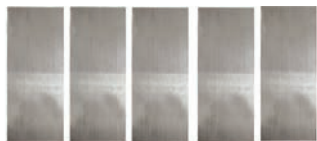

No.	For / Dla	
06796	06795	10/100

EN Scraper for glass and gaskets
 PL Skrobak do szyb i uszczelek
 DE Schaber für Glas und Dichtungen
 RU Скребок для стекла и прокладки
 CS Škrabky na sklo
 RO Răzuitor
 HU Kaparó eszköz
 ES Rasqueta



No.		
06790		6/36

EN Scraper for concrete floor
 PL Skrobak do betonu bez trzonkiem
 DE Betonschaber
 RU Скребок напольный для бетона
 CS Škrabka
 RO Răzuitor
 HU Kaparó
 ES Raspador obra suel



No.	Blade size / Rozmiar ostrza [mm]	
05760	120x350	12/24
05761	120x250	12/24

EN Blade for scraper
 PL Wymienne ostrze do skrobaka do betonu
 DE Klinge für Betonschaber
 RU Лезвие к скребку для бетонного пола
 CS Škrabka vyměnitelná čepel
 RO Lamă de schimb
 HU Kaparó cserélhető penge
 ES Răzuitor lamă de schimb



No.	Blade size / Rozmiar ostrza [mm]	
05773	150x250	25/50
05774	150x350	25/50

EN Telescopic scraper
 PL Skrobak teleskopowy
 DE Teleskop Schaber
 RU Скребок телескопический
 CS Teleskopický stěrač
 RO Răzuitor flexibil
 HU Teleszköpos jégkaparó
 ES Telescópico raspador



No.		
06799		16/96

EN Scraper for concrete floor
 PL Skrobak do betonu z trzonkiem
 DE Betonschaber
 RU Скребок напольный для бетона
 CS Škrabka
 RO Răzuitor
 HU Kaparó
 ES Raspador obra suel



No.	Blade size / Rozmiar ostrza [mm]	L [mm]	
05750	75x200	1300	10
05751	75x300	1300	10
05752	75x400	1300	10

EN Blade for scraper
 PL Wymienne ostrze do skrobaka do betonu
 DE Klinge für Betonschaber
 RU Лезвие к скребку для бетонного пола
 CS Škrabka vyměnitelná čepel
 RO Lamă de schimb
 HU Kaparó cserélhető penge
 ES Răzuitor lamă de schimb



No.	Blade size / Rozmiar ostrza [mm]	
05770	100x200	25/50
05771	100x300	25/50
05772	100x400	25/50

EN Mason's pan
 PL Czerpak murarski
 DE Gipspfänchen
 RU Ковш штукатурный
 CS Zednický koreček
 RO Cancioc
 HU Kőműveskanál
 ES Achicador de albanil



No.		
06335		50

EN Building strainer
 PL Sito budowlane
 DE Bau Sieb
 RU Сито строительное
 CS Prohazovací sito stavební
 RO Sită construcții
 HU Építőipari rosta
 ES Cedazo para construcción



VOREL

11

No.	Dimensions / Wymiary [cm]	Eyelet size / Rozmiar oczka [mm]	
34944	60x100	4	30
34945	60x100	6	5/30
34946	60x100	8	5/30
34947	60x100	10	30

EN Mixer for compound and glue
 PL Mieszadło do zapraw i klejów
 DE Mörtelrührer
 RU Мешалка для клеевой массы и цемента

CS Míchadlo na maltu a lepidla
 RO Agitator pt. mortar și cleiuri
 HU Habarcs és ragasztó keverő
 ES Mezcladora para morteros y pegamentos



VOREL

No.	Ø [mm]	L [mm]	
09010	90	510	40

EN Mixer for gypsum and coat
 PL Mieszadło do gipsu i gładzi
 DE Gips- und Wachsührer
 RU Мешалка для гипса

CS Míchadlo na sádku a stěrku
 RO Agitator pt. ipsos și honuituri
 HU Gipsz és glett keverő
 ES Mezcladora para yeso



No.	Ø [mm]	L [mm]	Type / Typ	
09025	75	370	C-75	20

EN Paint mixer
 PL Mieszadło do farbu
 DE Farbmischer
 RU Мешалка для краски

CS Míchadlo na hmoty
 RO Mixer vopsea / var
 HU Keverő festékekhez
 ES Mezclador para pinturas



VOREL

No.	Ø [mm]	L [mm]	
09060	60	400	40/80
09080	85	400	40/80
09090	100	600	30

EN Mixer for compound and glue
 PL Mieszadło do zapraw i klejów
 DE Wendelrührer
 RU Мешалка для клеевой массы и цемента
 CS Míchadlo na maltu a lepidla
 RO Agitator pt. mortar și cleiuri
 HU Habarcs és ragasztó keverő
 ES Mezcladora para morteros y pegamentos



VOREL

No.	Ø [mm]	L [mm]	
09005	65	410	40
09006	80	410	40

EN Mixer for gypsum and coat
 PL Mieszadło do gipsu i gładzi
 DE Gips- und Wachsührer
 RU Мешалка для гипса

CS Míchadlo na sádku a stěrku
 RO Agitator pt. ipsos și honuituri
 HU Gipsz és glett keverő
 ES Mezcladora para yeso



VOREL

No.	Ø [mm]	L [mm]	
09015	85	400	40
09017	100	500	20

EN Grout mixer
 PL Mieszadło do fug
 DE Mörtelrührer
 RU Миксер для расшивочных растворов

CS Míchadlo do spárovací hmoty
 RO Malaxor pt. ciment
 HU Fugakeverő szár
 ES Mezclador para mecheda del azulejo



VOREL

No.	Ø [mm]	L [mm]	
09031	75	300	10

EN Grout double mixer
 PL Mieszadło do fug podwójne
 DE Doppel-Mörtelrührer
 RU Миксер для расшивочных растворов даоной
 CS Michadlo do spárovací hmoty dvojité
 RO Malaxor dublu pt. ciment
 HU Dupla fugakeverő szár
 ES Mezclador doble para lechada del azulejo



VOREL

No.	Ø [mm]	L [mm]	
09032	75	500	10

EN Mixer for compound
 PL Mieszadło do mas
 DE Rührer für Materialien auf Bitumenbasis
 RU Мешалка для штукатурки

CS Michadlo na stavební hmoty
 RO Agitator pt. mase
 HU Keverő masszához
 ES Mezcladora para masas



No.	Ø [mm]	L [mm]	Type / Typ	
09048	75	400	C-75	20
09049	85	450	C-85	20
09050	100	500	C-100	20
09051	110	550	C-110	20

EN Mixer for compound
 PL Mieszadło do mas
 DE Rührer für Materialien auf Bitumenbasis
 RU Мешалка для штукатурки

CS Michadlo na stavební hmoty
 RO Agitator pt. mase
 HU Keverő masszához
 ES Mezcladora para masas



No.	Ø [mm]	L [mm]	
09054	80	400	25
09056	100	600	25

EN Mixer for compound
 PL Mieszadło do mas
 DE Rührer für Materialien auf Bitumenbasis
 RU Мешалка для штукатурки

CS Michadlo na stavební hmoty
 RO Agitator pt. mase
 HU Keverő masszához
 ES Mezcladora para masas



No.	Ø [mm]	L [mm]	
09036	60	400	60
09038	80	400	35
09040	100	600	30

EN Mixer for compound
 PL Mieszadło do mas
 DE Rührer für Materialien auf Bitumenbasis
 RU Мешалка для штукатурки
 CS Michadlo na stavební hmoty
 RO Agitator pt. mase
 HU Keverő masszához
 ES Mezcladora para masas



No.	Ø [mm]	L [mm]	
09044	80	400	25
09046	100	600	25

EN Turbo mixer
 PL Mieszadło turbo
 DE Turborührer
 RU Миксер турбо

CS Turbo michadlo
 RO Malaxor turbo
 HU Turbó keverő szár
 ES Mezclador turbo



VOREL

No.	Ø [mm]	L [mm]	Type / Typ	
09052	120	550	C-120	10

EN Mixer for loose materials
 PL Mieszadło do materiałów sypkich
 DE Mischer
 RU Миксер для сыпучих материалов

CS Michadlo na sypké materiály
 RO Agitator pt. materiale vărsătoare
 HU Keverő szóródó anyagokhoz
 ES Mezcladora para materiales sueltos



No.	Ø [mm]	L [mm]	
09028	80	400	35

EN Spiral mixer
 PL Mieszadło spiralne
 DE Spiralrührer
 RU Миксер спиральный

CS Spirálové michadlo
 RO Malaxor spirala
 HU Spirális keverő
 ES Mezclador espiral



No.	Ø [mm]	L [mm]	Type / Typ	
09094	120	600	C-120	10

EN Mixer
 PL Mieszadło cynkowane SDS
 DE Rondenrührer
 RU Мешалка для штукатурки

CS Michadlo
 RO Mixer
 HU Keverő
 ES Mezcladora



No.	Ø [mm]	L [mm]	
09096	80	400	20
09097	100	500	20

EN Turbo threaded stirrer
 PL Mieszadło turbo z gwintem
 DE Turbomischer mit Gewinde
 RU Мешалка с резьбой

CS Michadlo turbo se závitem
 RO Dispozitiv de amestecat turbo cu filet
 HU Menetes, turbó keverő
 ES Turbo mezcladora con rosca



No.	Ø [mm]	L [mm]	
09063	115	580	10
09065	135	580	10

EN Wallpaper perforator
 PL Walek do perforacji tapet
 DE Tapetenperforierwalze
 RU Валик для перфорации обоев
 CS Perforační váleček na tapety
 RO Perforator de tapet
 HU Tapétaperforáló henger
 ES Rodillo para perforación de papel de pared



No.	W [mm]	
06457	150	6/36

EN Deaeration roller
 PL Walek do odpowietrzania
 DE Entlüftungsrolle
 RU Валик аэрационный
 CS Váleček na odvdzdušňování
 RO Rola pt. modelare sapa
 HU Levegőkinyomó henger
 ES Rodillo para hacer el vacío



No.	Size / Rozmiar [mm]	
06450	75x230	15
06452	123x230	10

EN Plastic paint mixer
 PL Mieszadło z tworzywa do farb
 DE Farbrührstab aus Kunststoff
 RU Пластиковый миксер для лакокрасочных материалов
 CS Plastové míchadlo do barev
 RO Mixer vopsea, plastic
 HU Műanyag festékeverő szár
 ES Mezclador de plástico para pintura



No.	Ø [mm]	L [mm]	
09077	80	500	10

EN Turbo threaded mixer
 PL Mieszadło turbo z gwintem
 DE Turborührer mit Gewinde
 RU Миксер турбо с резьбой

CS Turbo míchadlo se závitem
 RO Malaxor cu filet, turbo
 HU Menetes turbó keverő szár
 ES Mezclador turbo con rosca



No.	Ø [mm]	L [mm]	
09062	100	500	20

EN Squeegee for wallpapers
 PL Rakiel do tapet
 DE Tapetenrakel
 RU Ракель для обоев
 CS Škrabka na tapety
 RO Racleta pt. tapet
 HU Tapétalenyomó
 ES Rasqueta para papel de pared



No.	Size / Rozmiar [mm]	
06460	280x165	120

EN Deaeration roller
 PL Walek do odpowietrzania
 DE Entlüftungsrolle
 RU Валик аэрационный

CS Váleček na odvdzdušňování
 RO Rola pt. modelare sapa
 HU Levegőkinyomó henger
 ES Rodillo para hacer el vacío



No.	Size / Rozmiar [mm]	
06453	110x500	2

EN Plaster roller
 PL Walek do gładzi gipsowych
 DE Rollspachtel-Walze
 RU Валик для шпаклевки
 CS Váleček na sádrovou omítku
 RO Trafalet
 HU Glettelő henger
 ES Rodillo para masillar

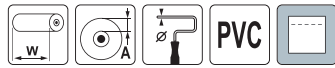

No.	W [mm]	A [mm]	Ø [mm]	
09445	230	55	6	48

EN Handy paint roller
 PL Walek malarski ze zbiornikiem na farbę
 DE Malerrolle mit Farbbehälter
 RU Малерный валик с емкостью для краски
 CS Malířský váleček s nádobou na barvu
 RO Trafalet cu rezervor
 HU Festőhenger festékadagoló tartállyal
 ES Rodillo de pintura con depósito



No.	W [mm]	L [mm]	
09397	230	1750	6

EN Paint roller Girpaint
 PL Walek malarski Girpaint
 DE Malerroller Girpaint
 RU Валик полиакрил в сборе
 CS Malířský váleček Girpaint
 RO Trafalet cu fir galben
 HU Festőhenger Girpaint
 ES Rodilli de pintura Girpaint

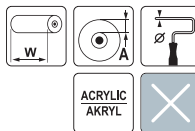

No.	W [mm]	A [mm]	Ø [mm]	
09334	100	9	6	40
09336	180	18	6	60

EN Paint roller Flok
 PL Walek malarski Flok
 DE Malerroller Flok
 RU Валик в сборе мольтоплен
 CS Malířský váleček
 RO Trafalet burete fin
 HU Festőhenger
 ES Rodilli de pintura

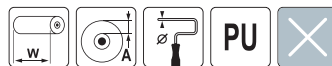

No.	W [mm]	A [mm]	Ø [mm]	
09359	150	50	6	50

EN Plaster roller replacement
 PL Zapasowy walek do gładzi gipsowych
 DE Rollspachtel-Ersatzwalze
 RU Запасной валик для шпаклевки
 CS Náhradní váleček na sádrovou omítku
 RO Rezerva trafalet
 HU Glettelő henger fej
 ES Recambio rodillo para masillar



No.	W [mm]	A [mm]	Ø [mm]	For / Dia	
09446	230	55	6	09445	50

EN Paint roller Syntex
 PL Walek malarski Syntex
 DE Malerroller Syntex
 RU Валик в сборе полиакрил
 CS Malířský váleček
 RO Trafalet Syntex
 HU Festőhenger
 ES Rodilli de pintura

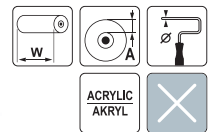

No.	W [mm]	A [mm]	Ø [mm]	
09307	180	20	6	55
09308	250	20	6	50

EN Paint roller Vestan
 PL Walek malarski Vestan
 DE Malerroller
 RU Валик в сборе, полиакрил
 CS Malířský váleček
 RO Trafalet lana artificiala
 HU Festőhenger
 ES Rodilli de pintura

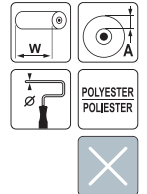

No.	W [mm]	A [mm]	Ø [mm]	
09345	180	15	6	55
09346	250	15	6	50

EN Paint roller Moltopren
 PL Walek malarski Moltopren
 DE Malerroller Moltopren
 RU Валик в сборе поролон
 CS Malířský váleček
 RO Trafalet burete cu tija plastic
 HU Festőhenger
 ES Rodilli de pintura

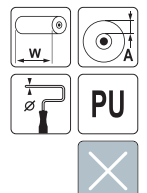

No.	W [mm]	A [mm]	Ø [mm]	
09370	50	35	6	70

EN Paint roller Moltopren
 PL Walek malarski Moltopren
 DE Malerroller Moltopren
 RU Валик в сборе поролон
 CS Malířský váleček
 RO Trafalet Burete cu tija plastic
 HU Festőhenger
 ES Rodilli de pintura

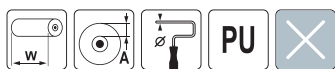

VOREL

No.	W [mm]	A [mm]	Ø [mm]	
09371	70	35	6	80
09372	100	35	6	70
09373	150	50	6	50

EN Paint roller refill Syntex
 PL Zapas do walka Syntex
 DE Maler-Ersatzwalzen Syntex
 RU Шубка полиакриловая для валика

CS Náhradní váleček Syntex
 RO Rezerva Trafalet Acril Verde
 HU Csere festőhengerhez
 ES Repuesto para el cilindro Syntex

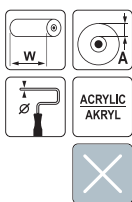

VOREL

No.	W [mm]	A [mm]	Ø [mm]	
09310	180	20	6	10/40
09311	250	20	6	40

EN Paint roller refill Girpaint
 PL Zapas do walka Girpaint
 DE Maler-Ersatzwalzen Girpaint
 RU Шубка полиамидная для валика

CS Náhradní váleček Girpaint
 RO Rezerva trafolet fir galben
 HU Csere festőhenger Girpaint
 ES Repuesto para el cilindro Girpaint

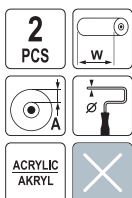

VOREL

No.	W [mm]	A [mm]	Ø [mm]	
09338	100	9	6	150

EN Paint roller refill Moltopren
 PL Zapas do walka Moltopren
 DE Maler-Ersatzwalzen Moltopren
 RU Шубка мольтопрен

CS Náhradní váleček Moltopren
 RO Rezerve trafolet burete
 HU Csere festőhenger Moltopren
 ES Esponja de recambio

VOREL

No.	W [mm]	A [mm]	Ø [mm]	
09375	50	35	6	200
09377	100	35	6	90
09378	150	50	6	45

EN Paint roller refill Multicolor
 PL Zapas do walka Multicolor
 DE Maler-Ersatzwalzen Multicolor
 RU Шубка полиамидовая для валика

CS Náhradní váleček Multicolor
 RO Rezerva trafolet fir Multicolor
 HU Csere festőhenger Multicolor
 ES Lana de polietileno Multicolor



VOREL

No.	W [mm]	A [mm]	Ø [mm]	
09302	180	15	6	40
09303	250	15	8	25

EN Paint roller refill
 PL Zapas do walka
 DE Maler-Ersatzwalzen
 RU Шубка нейлоновая для валика

CS Náhradní váleček
 RO Rezerva trafolet acril rosu
 HU Csere festőhenger
 ES Repuesto para el cilindro



VOREL

No.	W [mm]	A [mm]	Ø [mm]	
09331	180	6	6	10/50
09332	250	6	8	10/40

EN Paint roller refill Flok
 PL Zapas do walka Flok
 DE Maler-Ersatzwalzen Flok
 RU Шубка мольтопрен

CS Náhradní váleček Flok
 RO Rezerve trafolet burete fin
 HU Csere festőhenger Flok
 ES Esponja de recambio

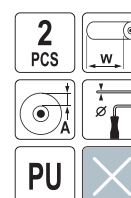

VOREL

No.	W [mm]	A [mm]	Ø [mm]	
09363	50	35	6	75
09365	100	35	6	80



EN Painting bowl
 PL Kuweta malarska
 DE Malerschale
 RU Ванночка малярная
 CS Malířská kůveta
 RO Tava-suport trafalet
 HU Kűveta
 ES Cuveta

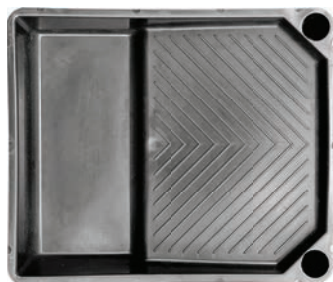

VOREL

No.	[mm]	
09406	150x245	75
09408	330x350	50

EN Paint roller set Vestan
 PL Walek malarski Vestan z kratką
 DE Malerroller Vestan mit Abtropfgitter
 RU Валик с решёткой
 CS Malířský váleček + mřížka
 RO Trafalet cu gratar
 HU Festőhenger + rács
 ES Rodillo de pintura + rejilla



VOREL

No.	W [mm]	Ø [mm]	
09385	180	6	25

EN Paint roller set Moltopren
 PL Walek malarski Moltopren z kuwetą
 DE Malerroller Moltopren mit Malerschale
 RU Набор для покраски: ванночка, валик
 CS Malířský váleček + kůveta
 RO Trafalet cu tava
 HU Festőhenger + kűveta
 ES Rodillo esponja + cuveta

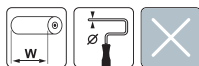

VOREL

No.	W [mm]	Ø [mm]	
09395	50	6	60

EN Flat paint brush
 PL Pędzel angielski
 DE Flachpinsel
 RU Кисть флейцевая
 CS Anglický štětec
 RO Pensulă englezească
 HU Laposecset
 ES Brocha plana



No.	W [mm]	H [mm]	
09521	25	44/39	50
09522	36	51/46	50
09523	50	51/46	50
09524	63	51/46	50
09525	76	51/46	50

EN Painting grid
 PL Kratka malarska
 DE Farbenabrollgitter
 RU Решетка малярная
 CS Malířská mřížka
 RO Gratar pt. zugrăvit
 HU Festőrács
 ES Rejilla para pintar

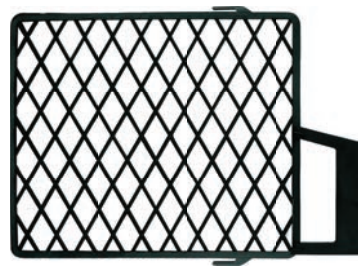

VOREL

No.	[mm]	
09413	265x285	100

EN Paint roller set Vestan
 PL Walek malarski Vestan z kuwetą
 DE Malerroller Vestan mit Malerschale
 RU Набор для покраски: ванночка, валик
 CS Malířský váleček
 RO Trafalet cu tava
 HU Festőhenger + kűveta
 ES Rodillo de pelo + cuveta

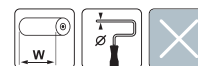

VOREL

No.	W [mm]	Ø [mm]	
09390	180	6	12

EN Paint roller handle
 PL Uchwyt do walka
 DE Malerroller-Griff
 RU Ручка для валика

CS Držák válečku
 RO Maner trafalet
 HU Festőhenger nyél
 ES Mango del cilindro

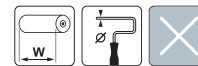

VOREL

No.	W [mm]	Ø [mm]	
09421	50/70	6	90
09422	100	6	90
09425	150	6	150
09427	180	6	110
09429	250	6	110
09430	250	8	80



- EN Flat paint brush profi
 PL Pędzel angielski profesjonalny
 DE Flachpinsel
 RU Кисть флейцевая
 CS Anglický štětec profesionální
 RO Pensulă englezască profesională
 HU Profesionális laposecset
 ES Brocha plana prof.



No.	W [mm]	H [mm]	
09531	25	51/46	50
09532	36	51/46	50
09533	50	57/52	50
09534	62	57/52	50
09535	75	57/52	50
09536	87	64/59	50
09537	102	64/59	50

- EN Round paint brush
 PL Pędzel okrągły
 DE Ringpinsel
 RU Кисть круглая
 CS Kulatý štětec
 RO Pensula rotundă
 HU Marokecset
 ES Brocha redonda



No.	W [mm]	H [mm]	
09581	20	44/39	50
09583	30	51/46	50
09585	40	51/46	50
09587	50	57/52	50
09589	60	57/52	50

- EN Paint brush
 PL Ławkowiec
 DE Malerbürste
 RU Кисть-макловица деревянная ручка
 CS Natírací kartáč profesionální
 RO Bidinea profesională
 HU Profesionális kenőkefe
 ES Brocha prof.



No.	W [mm]	H [mm]	
09647	170x65	64/58	10
09648	180x75	70/64	10
09649	190x85	76/68	10

- EN Angled paint brush
 PL Pędzel kaloryferowy
 DE Heizkörperpinsel
 RU Кисть радиаторная
 CS Štětec na topná tělesa
 RO Pensulă pt. calorifere
 HU Radiátorecset
 ES Brocha angular de radiadores



No.	W [mm]	H [mm]	
09560	25	44/39	50
09561	36	51/46	50
09562	50	51/46	50

- EN Brush for wallpapers
 PL Pędzel do tapet
 DE Flächenstreicher
 RU Кисть-макловица деревянная ручка
- CS Štětec na tapety dřevěný
 RO Bidinea profi pt. tapet
 HU Ecset fa tapétákhoz
 ES Brocha de empapelar madera

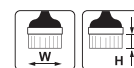

No.	W [mm]	H [mm]	
09636	110x30	51/46	30
09638	130x30	51/46	30
09640	140x40	57/52	30
09642	150x50	64/59	30

- EN Paint brush
 PL Chłapacz PCV
 DE Deckenbürste
 RU Кисть-макловица ПВХ
 CS Smeták PVC
 RO Bidinea PVC
 HU PVC meszelő
 ES Brocha de PVC



No.	W [mm]	
09651	170x60	30

EN Paint brushes
 PL Pędzle malarskie
 DE Pinselset
 RU Набор кистей
 CS Sada malířských štětců
 RO Set pensule
 HU Festőecset készlet
 ES Brochas de pintar

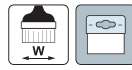

No.	W [mm]	pcs / szt.	
09920	25, 36, 50	3	25/200
09930	36, 50, 63	3	40/160
09950	15, 25, 36, 50, 63	5	25/100

EN Brush for pitch
 PL Smolowiec
 DE Pechstein
 RU Кисть для смолы

CS Kartáč asfaltěrský
 RO Perie pt. asfalt
 HU Kátránykenő kefe
 ES Brocha para alquitrán



No.	W [mm]	
09653	170	30

EN All purpose boot tray
 PL Wielofunkcyjna podstawa gospodarcza
 DE Garten- und Haushalt-Unterlage
 RU Многофункциональный поднос

CS Multifunkční podložka
 RO Tava multifunctionala
 HU Többfunkciós tálcá
 ES Bandeja de arranque universal

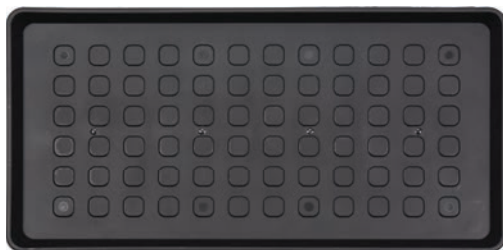
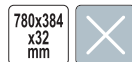

VOREL

No.	[mm]	
67260	780x384x32	30

EN Paint brush
 PL Ławkowiec PET
 DE Malerbürste
 RU Кисть-макловица PET
 CS Natíračí kartáč
 RO Bidinea
 HU Kenőkefe
 ES Brocha



VOREL

No.	W [mm]	
09655	150x70	12
09650	170x70	12
09656	180x80	10

EN Magnetic paint brush holder
 PL Uchwyt magnetyczny do pędzli
 DE Magnethalter für Pinsel
 RU Магнитный патрон для кистей
 CS Magnetický držák štětců
 RO Suport magnetic pt. pensule zugravit
 HU Mágneses ecsettartó
 ES Soporte magnético para pinceles

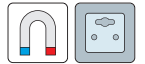

VOREL

No.	L [mm]	
09590	90	24/96

EN Sheet for construction works
 PL Folia ochronna malarska
 DE Abdeckplane
 RU Плёнка защитная
 CS Stavební fólie
 RO Folie pt. construcții
 HU Építési fólia
 ES Lona protectora



VOREL

No.	[m]	Thickness / Grubość [µm]	Material / Material	
09462	4x5	5	HDPE	40
09463	4x5	15	LDPE	20

- EN Sheet for construction works
 PL Folia budowlana mocna
 DE Abdeckplane
 RU Пленка защитная строительная повышенной прочности
 CS Stavební fólie
 RO Folie pt. constructii
 HU Építési fólia
 ES Lona protectora



No.	[m]	Thickness / Grubość [µm]	pcs / szt.	
09457	4x5	20	15	
09459	4x5	30	10	

- EN Construction waste bags
 PL Worki na odpady budowlane
 DE Müllsäcke
 RU Мешки для строительного мусора
 CS Pytle na stavební odpad
 RO Sacii gunoi pt. santier
 HU Zsák építési törmelékhez
 ES Bolsas para desperdicios de construcción



No.	Capacity / Pojemność [l]	Thickness / Grubość [µm]	pcs / szt.	
09470	80	40	10	30
09471	120	60	15	10

- EN Self adhesive paper tape
 PL Taśma papierowa samoprzylepna
 DE Papierband selbstklebend
 RU Лента малярная бумажная
- CS Páska papírová samolepicí
 RO Banda adeziva hartie
 HU Öntapadó papírszalag
 ES Self adhesive paper tape



No.	W [mm]	L [m]	
75270	19	25	12/48
75271	25	25	36
75272	30	25	10/40
75273	38	25	6/24
75274	48	25	6/24
75285	25	50	9/36
75286	30	50	10/40
75287	38	50	6/24
75288	48	50	6/24

- EN Debris bags
 PL Worki na gruz, mocne
 DE Müllsäcke stabil
 RU Мешки для строительного мусора
 CS Pytle na suť
 RO Sacii pt. demolari
 HU Sittes zsák
 ES Bolsas para escombros



No.	Capacity / Pojemność [l]	Thickness / Grubość [µm]	pcs / szt.	
09475	80	142	10	10
09476	80	142	3	10
09477	120	142	10	10
09478	120	142	3	10

- EN Waste bags for styrofoam
 PL Worki na styropian
 DE Styropor Entsorgungssäcke
 RU Пакеты для мусора строительные материалы
- CS Pytle na polystyren
 RO Sacii gunoi
 HU Szemeteszák
 ES Sacos de poliestireno



No.	Capacity / Pojemność [l]	Thickness / Grubość [µm]	pcs / szt.	
09472	240	40	10	10

- EN Blue masking tape
 PL Taśma maskująca, niebieska
 DE Malerei blau Tape
 RU Малярна стрічка
- CS Maskovací páska
 RO Bandă de mascare
 HU Fedőszalag
 ES Blue masking tape



No.	W [mm]	L [m]	
75120	30	25	40
75121	38	25	24
75122	48	25	24
75123	30	50	40
75124	38	50	24
75125	48	50	24

EN Plastering tape
 PL Taśma tynkarska elewacyjna
 DE Putzband
 RU Штукатурные лента
 CS Fasádní omítková páska
 RO Banda mascare pt. tencuieli
 HU Homlokzati festő szalag
 ES Plastering tape

20m 50m



VOREL

No.	W [mm]	L [m]	
75130	38	20	24
75131	48	20	24
75132	38	50	28
75133	48	50	24

EN Double-sided carpet tape
 PL Taśma dwustronna do wykładzin
 DE Doppelseitiges Klebeband für Auslegware
 RU Двухсторонняя клейкая лента для укладки ковровых покрытий
 CS Obojstranná lepicí páska (na podlahové krytiny)
 RO Bandă cu două părți adezive pt. mochete
 HU Kétoldalas szalag szőnyegpadlókhoz
 ES Double-sided carpet tape

DOUBLE-SIDED DWUSTRONNA



VOREL

No.	W [mm]	L [m]	
75260	50	5	48
75261	50	10	36
75262	50	25	24

EN Double-sided tape
 PL Taśma dwustronna na folii
 DE Doppelseitiges Band auf PP-Folie
 RU Клейкая лента двухсторонняя на полипропиленовой основе
 CS Obojstranná páska na PP folii
 RO Bandă cu două fețe pt. folii
 HU Kétoldalas ragasztószalag
 ES Double-sided tape

DOUBLE-SIDED DWUSTRONNA **PP**



VOREL

No.	W [mm]	L [m]	
75245	50	5	72
75246	50	10	72
75247	50	25	36

EN Aluminium tape
 PL Taśma aluminiowa
 DE Aluminiumband
 RU Алюминиевая клейкая лента
 CS Hliníková páska
 RO Bandă aluminiu
 HU Alumínium szalag
 ES Aluminium tape

Al



VOREL

No.	W [mm]	L [m]	
75140	48	10	36
75141	48	50	24

EN „DUCT” tape
 PL Taśma tekstylna „DUCT”
 DE Textilband „DUCT”
 RU Лента армированная на тканевой основе
 CS Textilní páska „DUCT”
 RO Bandă textilă „DUCT”
 HU „DUCT” textil szalag
 ES „DUCT” tape

DUCT



VOREL

No.	W [mm]	L [m]	
75238	48	10	24
75239	38	50	28
75240	48	50	24

EN Mounting tape
 PL Taśma samoprzylepna dwustronna
 DE Doppelseitiges montageband
 RU Двухсторонняя монтажная лента
 CS Páska montážní dvouvrstvá
 RO Scotch cu banda dubla
 HU Kétoldalas ragasztószalag
 ES Cinta adhesiva de doble cara

2 PCS 2.25m 19mm 5m 19mm



VOREL

No.	W [mm]	L [m]	
75100	19	2.25, 5	12/96

EN Packing tape, brown
 PL Taśma pakowa brązowa
 DE Verpackungsband aus PP, braun
 RU Упаковочная клейкая лента
 CS Balící páska PP hnědá
 RO Bandă ambalare PP maro
 HU PP barna ragasztószalag
 ES Packing tape, brown



No.	W [mm]	L [m]	
75301	48	40	36
75302	48	66	36

EN Packing tape
 PL Taśma pakowa
 DE Band
 RU Упаковочная клейкая лента
 CS Balící páska
 RO Banda scotch
 HU Csomagolószalag
 ES Cinta de embalaje



No.	W [mm]	L [m]	
75300	48	45	12/36

EN Plastic bucket
 PL Wiadro budowlane
 DE Baueimer
 RU Ведро строительное
 CS Stavební vědro
 RO Găleată pt. construcții
 HU Kőműves vödör
 ES Cubo de obra



No.	Capacity / Pojemność [l]	
06388	10	900
06390	12	680
06393	16	450
06392	20	390

EN Painting bucket
 PL Wiadro malarskie
 DE Malereimer
 RU Ведро малярное пластмассовое
 CS Vědro malířské
 RO Găleată zidar
 HU Festővödör
 ES Cubo para pintar



No.	Capacity / Pojemność [l]	Dimensions / Wymiary [mm]	
09400	14	360x250x225	315

EN Packing tape, transparent
 PL Taśma pakowa przezroczysta
 DE Verpackungsband aus PP, durchsichtig
 RU Упаковочная клейкая лента
 CS Balící páska PP průhledná
 RO Bandă ambalare PP transparentă
 HU Átlátszó ragasztószalag
 ES Packing tape, transparent



No.	W [mm]	L [m]	
75303	48	40	36
75304	48	66	36

EN PVC tape
 PL Taśma PCV do użytku zewnętrznego
 DE PVC Band
 RU Лента ПВХ для внешних работ
 CS Páska PVC
 RO Bandă PVC
 HU Kétoldalas PVC
 ES Cinta de PVC para exteriores



No.	W [mm]	L [m]	
75301	48	33	50

EN Plastic bucket
 PL Wiadro budowlane z wylewką
 DE Baueimer
 RU Ведро строительное со сливом
 CS Stavební vědro
 RO Găleată pt. construcții
 HU Kőműves vödör
 ES Cubo de obra con pico



No.	Capacity / Pojemność [l]	
06391	12	720

EN Tub for mass mixing
 PL Kastrta budowlana
 DE Mörtelkasten
 RU Таз строительный круглый
 CS Stavební vědro
 RO Vas plastic constructii
 HU Kőműves vödör
 ES Cubo de obra



No.	Capacity / Pojemność [l]	
06397	40	110
06398	65	100
06399	90	160

EN Tub for mass mixing
 PL Kastrą budowlaną
 DE Mörtelkasten
 RU Кювета для перемешивания раствора

CS Stavební vědro
 RO Vas plastic constructii
 HU Kőműves vödör
 ES Caba de obra



No.	Capacity / Pojemność [l]	
06394	40	210
06395	60	210
06396	90	120

EN Galvanized bucket
 PL Wiadro ocynkowane
 DE Baueimer
 RU Ведро оцинкованное
 CS Vědro
 RO Găleată
 HU Kőműves vödör
 ES Cubo



No.	Capacity / Pojemność [l]	
89560	5	900
89561	7	750
89562	10	600
89563	12	500
89564	15	350

EN Suction lifter
 PL Uchwyt-przyssawka do szyb
 DE Glas-Gummissauger
 RU Держатель-присоска для стекол двойная
 CS Podtlakový držák na sklo
 RO Ventuza
 HU Szélvédő kiemelő
 ES Elevador tipo ventosa



No.	Ø [mm]	Max. lifting capacity / Maks. udźwig [kg]	
05301	115	70	24

EN Suction lifter
 PL Uchwyt-przyssawka do szyb
 DE Glas-Gummissauger
 RU Держатель-присоска для стекол двойная
 CS Podtlakový držák na sklo
 RO Ventuza
 HU Szélvédő kiemelő
 ES Elevador tipo ventosa



No.	Ø [mm]	Max. lifting capacity / Maks. udźwig [kg]	
05311	115	40	50

EN Garden bucket
 PL Wiadro ogrodnicze
 DE Garten Eimer
 RU Ведро огородное

CS Zahradní vědro
 RO Găleată de grădină
 HU Kerti vödör
 ES Cubo de jardín



No.	Capacity / Pojemność [l]	
35600	15	500

EN Suction lifter
 PL Uchwyt-przyssawka do szyb
 DE Glas-Gummissauger
 RU Держатель-присоска для стекол
 CS Podtlakový držák na sklo
 RO Ventuza
 HU Szélvédő kiemelő
 ES Elevador tipo ventosa



No.	Ø [mm]	Max. lifting capacity / Maks. udźwig [kg]	
05300	115	40	48

EN Suction lifter
 PL Uchwyt-przyssawka do szyb
 DE Glas-Gummissauger
 RU Держатель-присоска для стекол тройная
 CS Podtlakový držák na sklo
 RO Ventuze
 HU Szélvédő kiemelő
 ES Elevador tipo ventosa



No.	Ø [mm]	Max. lifting capacity / Maks. udźwig [kg]	
05302	115	100	12

EN Suction lifter
 PL Uchwyt-przyssawka do szyb
 DE Glas-Gummissauger
 RU Держатель-присоска для стекол двойная
 CS Podtlakový držák na sklo
 RO Ventuze
 HU Szélvédő kiemelő
 ES Elevador tipo ventosa



No.	Ø [mm]	Max. lifting capacity / Maks. udźwig [kg]	
05312	115	70	10

EN Hook
 PL Hak budowlany
 DE Mauerhaken
 RU Крюк строительный
 CS Stavební hák
 RO Cârlig de construcții
 HU Építőipari horog
 ES Gancho de obra



JUCO

No.		
34950		25

EN Carpenter's pencil sharpener
 PL Temperówka do ołówek stolarskich
 DE Zimmermann-Bleistift-Anspitzer
 RU Точилка для столярных карандашей
 CS Ořezávkó na tesařskou tužku
 RO Ascuitoare pt. creioane de tamplarie
 HU Ceruzahegyező
 ES Sacapuntas para lápiz de carpintero



VOREL

No.		
09190		40/240

EN Spacer pads
 PL Podkładki dystansowe do zbrojeń
 DE Bewehrung Abstandhalter
 RU Фиксатор опоры для арматуры
 CS Distanční podložka
 RO Distanțiere pt. armare
 HU Távtartó
 ES Separador corona



VOREL

No.	Cleaving thickness / Grubość otuliny [mm]	pcs / szt.	
49780	10-20	50	50
49781	20-25	50	40
49782	25-30	50	30

EN Plastic bridge spacer
 PL Listwy dystansowe do zbrojeń
 DE Abstandleiste
 RU Раскладка для установки арматуры

CS Distanční lišta plastová
 RO Distanțiere pt. armare tip pod
 HU Távtartó
 ES Separadores lineales



VOREL

No.	L [m]	Cleaving thickness / Grubość otuliny [mm]	pcs / szt.	
49790	1	20	10	1
49791	1	25	10	1
49792	1	30	10	1

EN Carpenter's pencil
 PL Ołówek stolarski
 DE Zimmermannsbleistift
 RU Карандаш столярный
 CS Tesařská tužka
 RO Creion de tâmplărie
 HU Asztalos ceruza
 ES Lapiz de carpintero



No.	L [mm]	pcs / szt.	
09180	180	12	60/240

EN Wire tying twister hook
 PL Klucz do wiązania drutu zbrojeniowego
 DE Rödeldraht-Drillkurbel
 RU Крючок для вязки арматуры
 CS Radlovačka
 RO Dispozitiv pt. legat fier beton
 HU Huzalsodró
 ES Gancho para amarrar alambre



VOREL

No.	L [mm]	
49830	240	20

EN Spacer pads
 PL Podkładki dystansowe do zbrojeń
 DE Bewehrung Abstandhalter
 RU Фиксатор опоры для арматуры
 CS Distanční podložka
 RO Distanțiere pt. armare
 HU Távtartó
 ES Separador corona



VOREL

No.	Cleaving thickness / Grubość otuliny [mm]	pcs / szt.	
49785	15-20	50	40
49786	20-25	50	30
49787	25-30	50	20

EN Hand bar bender
 PL Klucz do gięcia prętów
 DE Metallbieger
 RU Рычажный трубогиб
 CS Ruční ohýbačka
 RO Dispozitiv de indoit
 HU Kézi betonacél hajlító
 ES Curvador de tubos

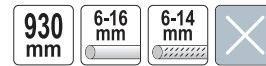

VOREL

No.	L [mm]	
49810	930	4

EN Bearing bender for bar
 PL Giętarka łożyskowana do drutu
 DE Drahtbiegevorrichtung, mit Lager
 RU Ручной станок для гибки арматуры

CS Ohýbačka drátu s ložiskem
 RO Dispozitiv pt. îndoit suport sârmă
 HU Csapágyas dróthajlító
 ES Dobladora de alambre con rodamiento



VOREL

No.	Ø [mm]	Dimensions / Wymiary [mm]	Bearing / Łożysko [mm]	
49805	6-8	17x17x5	35x15	2
49806	10-14	25x20x5	45x20	2

EN Longitudinal clamp
 PL Chwytek brukarski wzdłużny regulowany
 DE Bordstein-Verlegezange
 RU Захват-клевщи для бордюра продольные

CS Kleště na obrubníky podélné
 RO Cleste pt. borduri
 HU Hosszirányúszegélykő emelő fogó
 ES Pinza de colocación de rebordes mecánica



VOREL

No.	Grip range / Zakres chwytu [mm]	
35010	980-1170	2

EN Rubber for lateral clamp
 PL Zapasowe końcówki do chwytaka
 DE Ersatzgummi für Bordsteinverlegezange
 RU Запасные наконечники
 CS Náhradní gumový úchyt
 RO Mânere de cauciuc de rezervă
 HU Gumi alkatrészek
 ES Punta de repuesto



VOREL

No.	For / Dia	pcs / szt.	
35013	35012	4	10

EN Slabgrabber
 PL Chwytek brukarski jednoręczny regulowany
 DE Pflasterstein- und Klinker-Träger
 RU Захваты для тротуарной плитки кирпича, блоков
 CS Kleště na dlažbu a cihly
 RO Cleste pt. caramizi
 HU Burkolólap fogó
 ES Pinza de colocación de losas



VOREL

No.	Grip range / Zakres chwytu [mm]	
35017	255-400	4

EN Bender for reinforcement bar
 PL Giętarka do drutu zbrojeniowego
 DE Biegevorrichtung für Bewehrungsdraht
 RU Ручной станок для гибки арматуры

CS Ohýbačka armovaciaho drátu
 RO Dispozitiv pt. îndoit sârmă de armare
 HU Betonvas hajlító
 ES Dobladora de alambre de reforzamiento



VOREL

No.	Ø [mm]	Dimensions / Wymiary [mm]	
49800	6-8	16x12x5	4
49801	10-12	25x16x6	4
49802	14-16	25x16x6	2

EN Lateral clamp
 PL Chwytek poprzeczny, podwójny
 DE Bordsteinverlegezange
 RU Захват-клевщи для бордюра поперечные

CS Kleště na obrubníky příčné
 RO Cleste pt. borduri
 HU Kereszirányúszegélykő emelő fogó
 ES Pavimentación pinza doble



VOREL

No.	Grip range / Zakres chwytu [mm]	
35012	200-510	2

EN Grapple for cobblestones
 PL Chwytek zbiorczy do kostki brukowej
 DE Pflastersteinträger
 RU Захват ручной для переноса бордюрного камня и блоков

CS Nosič na cihly
 RO Cleste pt. borduri
 HU Emelő fogó
 ES Pinza para bordillos longitudinal



VOREL

No.	Grip range / Zakres chwytu [mm]	
35015	700-1100	4

EN Brick tongs
 PL Chwytek do podnoszenia płyt lub cegieł
 DE Greifer zum Heben von Platten oder Ziegeln
 RU Захват для подъема плит или кирпича
 CS Nástroj pro přenášení desek a cihel
 RO Cleste caramida
 HU Csempe- és téglafogó
 ES Pinzas para transportar placas o ladrillos



VOREL

No.	Grip range / Zakres chwytu [mm]	
35018	410-680	12

EN Paver puller
 PL Imak brukarski regulowany
 DE Steinzieher-Steinheber
 RU Захват для камня

CS Kleště na vyťahování dlažby
 RO Ridicator de pavele
 HU Térkökiemelő szerszám
 ES Extractor de adoquines



No.	Grip range / Zakres chwytu [mm]	
35020	80-275	4

EN Blades for paver puller
 PL Zapasowe ostrza do imaka
 DE Ersatzklingen für Steinzieher-Steinheber
 RU Запасные лезвия
 CS Náhradní čepel
 RO Tartalék penge
 HU Lame de rezerva
 ES Cuchillas de repuesto



No.	For / Dla	pcs / szt.	
35021	35020	2	20

EN Blade for paver adjuster
 PL Ostrze do łomu brukarskiego
 DE Ersatzklingen für Richteteisen
 RU Запасные лезвия
 CS Náhradní čepel
 RO Lame de rezerva
 HU Tartalék penge
 ES Cuchillas de repuesto



No.	For / Dla	
35026	35025	20

EN Paver lifter
 PL Zgarniacz brukarski do podsypki
 DE Plan-Abzieher für Pflasterbau
 RU Правило для выравнивания основания под тротуарную плитку
 CS Stahovací lišta
 RO Sistem de nivelare manuala
 HU Ágyazat leköz rendszer
 ES Sistema de enrasado manual

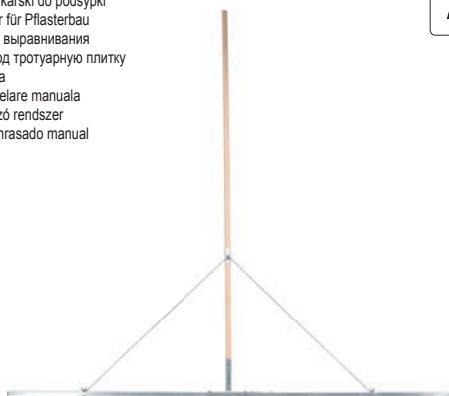

No.	L [cm]	
35031	150	1
35030	200	1

EN Paver adjuster
 PL Łom wyważak brukarski
 DE Richteteisen für Pflasterbau
 RU Лом с упором для демонтажа тротуарной плитки
 CS Tyc pro opravu dlažby
 RO Bara de aliniere pavaj
 HU Térkö-sorrendező
 ES Barra alineadora de adoquines



No.	
35025	4

EN Paver lifter
 PL Zgarniacz brukarski do podsypki
 DE Plan-Abzieher für Pflasterbau
 RU Правило для выравнивания основания под тротуарную плитку
 CS Stahovací lišta
 RO Sistem de nivelare manuala
 HU Ágyazat leköz rendszer
 ES Sistema de enrasado manual



No.	L [cm]	
35033	75	1
35032	120	1

EN Garden paving stone mould
 PL Forma do kostki brukowej
 DE Pflasterform
 RU Форма для брусчатки
 CS Forma pro dlažební kostky
 RO Matrita pt. pavaje
 HU Térkö-minta sablon
 ES Plantilla para adoquines



No.	Dimensions / Wymiary [mm]	
35060	430x425x40	10

EN Garden paving stone mould
 PL Forma do kostki brukowej
 DE Pflasterform
 RU Форма для брусчатки

CS Forma pro dlažební kostky
 RO Matrita pt. pavaje
 HU Térkő-minta sablon
 ES Plantilla para adoquines

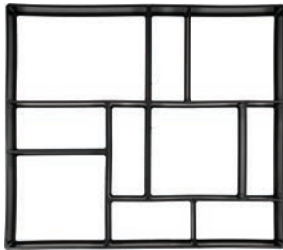

No.	Dimensions / Wymiary [mm]	
35061	450x400x40	10

EN Garden paving stone mould
 PL Forma do kostki brukowej
 DE Pflasterform
 RU Форма для брусчатки

CS Forma pro dlažební kostky
 RO Matrita pt. pavaje
 HU Térkő-minta sablon
 ES Plantilla para adoquines

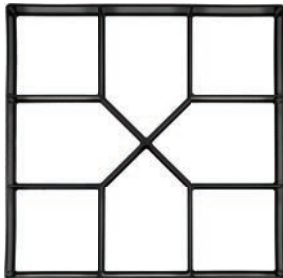

No.	Dimensions / Wymiary [mm]	
35063	400x400x40	10

EN Garden paving stone mould
 PL Forma do kostki brukowej
 DE Pflasterform
 RU Форма для брусчатки

CS Forma pro dlažební kostky
 RO Matrita pt. pavaje
 HU Térkő-minta sablon
 ES Plantilla para adoquines

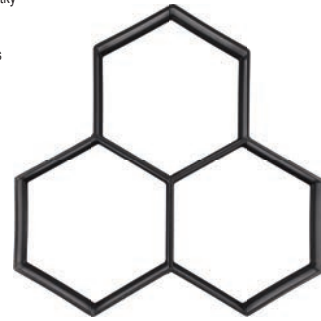

No.	Dimensions / Wymiary [mm]	
35062	360x360x40	10

EN Garden paving stone mould
 PL Forma do kostki brukowej
 DE Pflasterform
 RU Форма для брусчатки

CS Forma pro dlažební kostky
 RO Matrita pt. pavaje
 HU Térkő-minta sablon
 ES Plantilla para adoquines

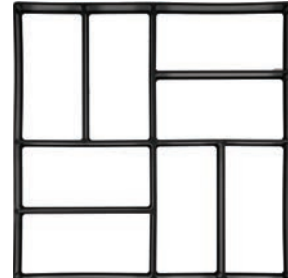

No.	Dimensions / Wymiary [mm]	
35064	400x400x40	10

Memo	
------	--

12

Measuring tools Narzędzia miernicze



Digital universal meters
Cyfrowe mierniki uniwersalne

.....190-191



Measuring tapes
Miary zwijane

.....191-192



Wooden folding rules
Miary składane drewniane

.....192



Plastic folding rules
Miary składane z tworzywa

.....193



Feeler gauges
Szczelinomierze

.....193



Vernier calipers
Suwmiarki

.....193-194



Chalk lines
Sznury traserskie

.....194



Ropes & lines
Sznury i linki

.....194-197



Plumb bobs
Piony murarskie

.....197-198



Try squares
Kątowniki stolarskie

.....198-200



Rulers
Przymiary

.....201



Electronic measuring tools
Elektroniczne urządzenia pomiarowe

.....201-204



Levels
Poziomnice

.....204-205



Scales
Wagi

.....205



Magnifiers
Lupy

.....205



EN Digital universal multimeter
 PL Cyfrowy miernik uniwersalny
 DE Digital-Multimeter
 RU Универсальный цифровой измеритель
 CS Digitální multimetr univerzální
 RO Multimetru digital universal
 HU Digitális multiméter
 ES Manómetro digital universal

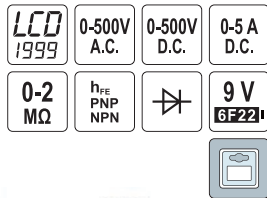

No.	Digit height / Wysokość cyfr [mm]	
81780	12/72	

EN Digital universal multimeter
 PL Cyfrowy miernik uniwersalny
 DE Digital-Multimeter
 RU Универсальный цифровой измеритель
 CS Digitální multimetr univerzální
 RO Multimetru digital universal
 HU Digitális multiméter
 ES Manómetro digital universal

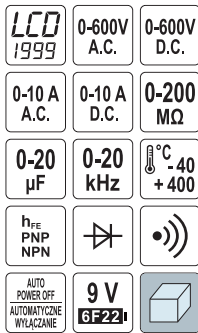

No.	Digit height / Wysokość cyfr [mm]	
81784	25	20

EN Digital universal multimeter
 PL Cyfrowy miernik uniwersalny
 DE Digital-Multimeter
 RU Универсальный цифровой измеритель
 CS Digitální multimetr univerzální
 RO Multimetru digital universal
 HU Digitális multiméter
 ES Manómetro digital universal

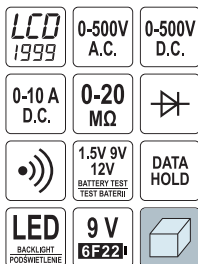

No.	Digit height / Wysokość cyfr [mm]	
81774		50

EN Digital universal multimeter
 PL Cyfrowy miernik uniwersalny
 DE Digital-Multimeter
 RU Универсальный цифровой измеритель
 CS Digitální multimetr univerzální
 RO Multimetru digital universal
 HU Digitális multiméter
 ES Manómetro digital universal

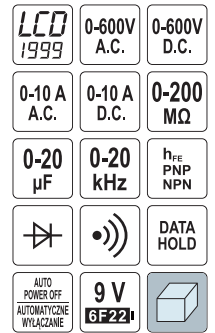

No.	Digit height / Wysokość cyfr [mm]	
81783	25	20

EN Digital universal multimeter
 PL Cyfrowy miernik uniwersalny
 DE Digital-Multimeter
 RU Универсальный цифровой измеритель
 CS Digitální multimetr univerzální
 RO Multimetru digital universal
 HU Digitális multiméter
 ES Manómetro digital universal

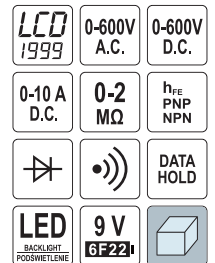

No.	Digit height / Wysokość cyfr [mm]	
81773		50

EN Digital universal multimeter
 PL Cyfrowy miernik uniwersalny
 DE Digital-Multimeter
 RU Универсальный цифровой измеритель
 CS Digitální multimetr univerzální
 RO Multimetru digital universal
 HU Digitális multiméter
 ES Manómetro digital universal

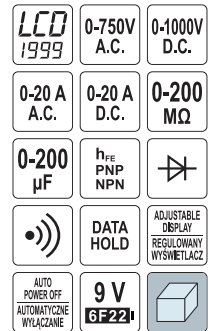

No.	Digit height / Wysokość cyfr [mm]	
81775		40

EN Clamp universal multimeter
 PL Cęgowy miernik uniwersalny
 DE Universal Zangenamperemeter
 RU Универсальный цифровой измеритель
 CS Digitální multimetr univerzální
 RO Multimetru digital universal
 HU Digitális multiméter
 ES Manómetro digital universal



LCD 1999 0-450V A.C.
 0-600V D.C. 0-400A A.C.
 0-200 KΩ
 DATA HOLD
 2x AAA



No.	5/60
81801	5/60

EN Measuring tape
 PL Miara zwijana
 DE Rollbandmass
 RU Рулетка
 CS Měřicí pásmo
 RO Rulete din pinza
 HU Mérőszalag
 ES Flexómetro



2x STOP



No.	L [m]	W [mm]	12/120
10061	3.0	16	12/120
10062	5.0	19	12/120
10063	5.0	25	12/96
10064	7.5	25	6/72
10065	10.0	25	6/60

EN Measuring tape
 PL Miara zwijana
 DE Rollbandmass
 RU Рулетка
 CS Měřicí pásmo
 RO Rulete din
 HU Mérőszalag
 ES Flexómetro



2x STOP



No.	L [m]	W [mm]	12/120
10130	2.0	16	12/120
10133	3.0	16	12/120
10135	5.0	16	12/120
10138	8.0	25	6/60
10139	10.0	25	6/60

EN Measuring tape
 PL Miara zwijana
 DE Rollbandmass
 RU Рулетка
 CS Měřicí pásmo
 RO Rulete din
 HU Mérőszalag
 ES Flexómetro



No.	L [m]	W [mm]	12/120
10101	2.0	16	12/120
10104	3.0	16	12/120
10106	5.0	16	12/120
10109	7.5	19	6/60
10111	10.0	25	6/60

EN Measuring tape
 PL Miara zwijana
 DE Rollbandmass
 RU Рулетка
 CS Měřicí pásmo
 RO Rulete din
 HU Mérőszalag
 ES Flexómetro



3x STOP



No.	L [m]	W [mm]	12/120
10122	2.0	16	12/120
10123	3.0	16	12/120
10125	5.0	19	12/120
10128	7.5	25	6/60
10129	10.0	25	6/60

EN Steel measuring tape
 PL Taśma miernicza stalowa
 DE Rollbandmass
 RU Мерная лента стальная
 CS Měřicí pásmo ocelové
 RO Ruleta din oțel
 HU Acél mérőszalag
 ES Cinta de medir de acero



No.	L [m]	W [mm]	12/120
12100	10	10	25/50
12200	20	10	25/50
12300	30	10	10/30
12500	50	10	10/30

EN Steel measuring tape
 PL Taśma miernicza stalowa, geodezyjna
 DE Rollbandmass
 RU Мерная лента стальная геодезийная

CS Měřicí pásmo ocelové
 RO Ruleta cu picior
 HU Acél mérőszalag
 ES Cinta de medir de acero geodésico



No.	L [m]	
13200	20	10/20
13300	30	10/20
13500	50	10/20

EN Fibreglass measuring tape
 PL Taśma miernicza z włókna szklanego
 DE Rollbandmass
 RU Мерная лента фиберглассовая
 CS Měřicí pásmo /skleněné vlákno/
 RO Ruleta fibra sticla
 HU Mérőszalag /üvegszál/
 ES Cinta de medir /fibra cristal/



No.	L [m]	
14300	30	12/60
14500	50	10/30

EN Wooden folding rule
 PL Miara drewniana, składana, okuta
 DE Gliedermasstab
 RU Метр складной деревянный
 CS Měřicí pásmo dřevěné skladané /okované/
 RO Metru tamplar lemn
 HU Fa colstok /vasalt/
 ES Metro de madera, plegable /articulado/



No.	L [m]	Series / Seria	
15004	1	PERFECT B-Z	20/200
15006	2	PERFECT B-Z	10/100

EN Fibreglass measuring tape
 PL Taśma miernicza z włókna szklanego
 DE Rollbandmass
 RU Мерная лента фиберглассовая

CS Měřicí pásmo /skleněné vlákno/
 RO Ruleta fibra sticla
 HU Mérőszalag /üvegszál/
 ES Cinta de medir /fibra cristal/



No.	L [m]	
14100	10	20/100
14200	20	12/60

EN Wooden folding rule
 PL Miara drewniana, składana, okuta
 DE Gliedermasstab
 RU Метр складной деревянный

CS Měřicí pásmo dřevěné skladané /okované/
 RO Metru tamplar lemn
 HU Fa colstok /vasalt/
 ES Metro de madera, plegable /articulado/



No.	L [m]	
15010	1	24/480
15020	2	12/240

EN Wooden folding rule
 PL Miara drewniana, składana, okuta
 DE Gliedermasstab
 RU Метр складной деревянный
 CS Měřicí pásmo dřevěné skladané /okované/
 RO Metru tamplar lemn
 HU Fa colstok /vasalt/
 ES Metro de madera, plegable /articulado/



No.	L [m]	Series / Seria	
15005	1	PERFECT B	20/200
15007	2	PERFECT B	10/100

EN Plastic folding rule
 PL Miara plastikowa
 DE Kunststoffgliedmasstab
 RU Метр складной пластмассовый
 CS Měřicí pásmo plastové skládané
 RO Metru de plastic
 HU Műanyag, összecusukható mérce
 ES Metro de plástico, plegable



No.	L [m]	
15050	1	20/200
15070	2	12/120

EN Plastic caliper
 PL Suwmiarka plastikowa
 DE Kunststoff-Bremssattel
 RU Штангенциркуль пластиковый
 CS Plastové posuvné měřtko
 RO Subler masurat sprancene
 HU Műanyag tolmérő
 ES Calibre vernier regla, plástico



No.	Measuring range / Zakres pomiaru [mm]	Measurement accuracy / Dokładność pomiarowa [mm]	
15120	0-150	± 0.05	50/500

EN Vernier caliper
 PL Suwmiarka
 DE Messschieber
 RU Штангенциркуль
 CS Posuvné měřtko
 RO Şubler
 HU Tolómérő
 ES Calibre



No.	Measuring range / Zakres pomiaru [mm]	Measurement accuracy / Dokładność pomiarowa [mm]	
15100	0-150	± 0.05	40

EN Dial caliper
 PL Suwmiarka zegarowa
 DE Präzisions-Uhrmessschieber
 RU Штангенциркуль стрелочный
 CS Posuvné měřtko hodinové
 RO Subler cu cadran
 HU Órás tolmérő
 ES Calibre dial



No.	Measuring range / Zakres pomiaru [mm]	Measurement accuracy / Dokładność pomiarowa [mm]	
15220	0-150	± 0.02	10/50

EN Feeler
 PL Szczelinomierz
 DE Fühlerlehre
 RU Шупы автомобильные
 CS Spároměr
 RO Lere
 HU Hézagmérő
 ES Calibre de fisuras



No.	Gauge thickness / Grubość listka [mm]	Gauge quantity / Liczba listków	
15130	0.05, 0.10, 0.15, 0.20, 0.25, 0.30, 0.40, 0.50, 0.60, 0.70, 0.80, 0.90, 1.0	13	15/300
15200	0.05, 0.10, 0.15, 0.20, 0.25, 0.30, 0.35, 0.40, 0.45, 0.50, 0.55, 0.60, 0.65, 0.70, 0.75, 0.80, 0.85, 0.90, 0.95, 1.0	20	10/200

EN Vernier caliper
 PL Suwmiarka
 DE Messschieber
 RU Штангенциркуль
 CS Posuvné měřtko
 RO Şubler
 HU Tolómérő
 ES Calibre



No.	Measuring range / Zakres pomiaru [mm]	Measurement accuracy / Dokładność pomiarowa [mm]	
15115	0-150	± 0.02	10/100

EN Vernier caliper
 PL Suwmiarka
 DE Messschieber
 RU Штангенциркуль
 CS Posuvné měřtko
 RO Şubler
 HU Tolómérő
 ES Calibre



No.	Measuring range / Zakres pomiaru [mm]	Measurement accuracy / Dokładność pomiarowa [mm]	
15110	0-150	± 0.02	10/100

EN Digital caliper
 PL Suwmiarka elektroniczna
 DE Digital Messschieber
 RU Штангенциркуль электронный
 CS Posuvné měřtko elektronické
 RO Şubler electronic
 HU Elektronikus tolmérő
 ES Calibre electrónico



No.	Measuring range / Zakres pomiaru [mm]	Measurement accuracy / Dokładność pomiarowa [mm]	
15240	0-150	± 0.03	10/40

- EN Carbon fibre vernier caliper
- PL Suwmiarka elektroniczna z włókna węglowego
- DE Elektronischer Messschieber aus Kohlefaser
- RU Электронный штангенциркуль из углеродного волокна
- CS Elektronické posuvné měřidlo z uhlíkového vlákna
- RO Subler din carbon
- HU Elektromos szénszálas tolómérő
- ES Calibre electrónico de fibra de carbono

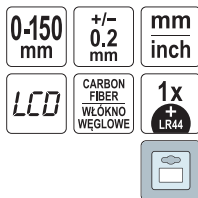

VOREL

No.	Measuring range / Zakres pomiaru [mm]	Measurement accuracy / Dokładność pomiarowa [mm]	
15113	0-150	± 0.2	25/100

- EN Chalk line
- PL Sznur traserski
- DE Schnurlot
- RU Шнур-отвес малярный
- CS Ořýsovací šňůra
- RO Șnur de trasat
- HU Kicsapózsínor
- ES Cordel tizador



VOREL

No.	L [m]	
17501	15	10/100

- EN Chalk line
- PL Sznur traserski w pojemniku
- DE Schlagschnurroller
- RU Шнур для разметки в контейнере
- CS Značkovací provázek v obalu
- RO Fir trasat cu creta
- HU Jelölőzsinór dobozban
- ES Tiralíneas para marcar



VOREL

No.	L [m]	
17506	30	12/48

- EN Builders line
- PL Sznurek murarski
- DE Maurerschnur
- RU Шнур - причалка
- CS Šňůra zednická
- RO Sfoară pt. zidari
- HU Kőműves zsinór
- ES Cuerda de albañil



No.	L [m]	
17490	40	80

- EN Chalk line
- PL Sznur traserski
- DE Schnurlot
- RU Шнур-отвес малярный
- CS Ořýsovací šňůra
- RO Șnur de trasat
- HU Kicsapózsínor
- ES Cordel tizador



No.	L [m]	
17500	15	10/100

- EN Chalk line & blue chalk
- PL Sznur traserski z kredą niebieską
- DE Schlagschnur mit Kreide
- RU Шнур-отвес малярный + краска
- CS Ořýsovací šňůra
- RO Fir trasare si praf de creta albastra
- HU Kicsapózsínor
- ES Cordel tizador con tiza azul



VOREL

No.	L [m]	m [g]	
17505	15	115	10/60

- EN Blue / red chalk
- PL Kreda traserska
- DE Kreide blau / rot
- RU Краска для шнура
- CS Křída trasovací
- RO Praf de creta pt. trasat
- HU Jelölő krétapor
- ES Tiza azul/rojo



VOREL

No.	m [g]	Color / Kolor	
17507	115	niebieski	20/80
17508	115	czerwony	20/80

- EN Builders line
- PL Sznurek murarski
- DE Maurerschnur
- RU Шнур - причалка
- CS Šňůra zednická
- RO Sfoară pt. zidari
- HU Kőműves zsinór
- ES Cuerda de albañil



VOREL

No.	L [m]	
17495	75	12/48

EN Builders line
 PL Sznurek murarski
 DE Maurerschnur
 RU Шнур - причалка
 CS Šňůra zednická
 RO Sfoară pt. zidari
 HU Kőműves zsinór
 ES Cuerda de albañil



No.	L [m]	
17495	75	12/48

EN Builders line
 PL Sznurek murarski
 DE Maurerschnur
 RU Шнур - причалка
 CS Šňůra zednická
 RO Sfoară pt. zidari
 HU Kőműves zsinór
 ES Cuerda de albañil



No.	Ø [mm]	L [m]	
17498	1.2	200	12/48

EN Polypropylene bricklayer's string
 PL Sznurek murarski, polipropylenowy
 DE Maurerschnur aus Polypropylen
 RU Шнур каменщика
 CS Šňůra zednická polypropylenová
 RO Șnur de zidărie din polietilena
 HU Kőműves zsinór, polipropilén
 ES Cordel de albañilería



No.	Ø [mm]	L [m]	
17470	1.7	50	60/240
17471	1.7	100	30/120
17473	2.0	50	60/240
17474	2.0	100	30/120

EN Polypropylene sennit line
 PL Linka pleciona polipropylenowa
 DE Geflochtenes Seil aus Polypropylen
 RU Канат полипропилен
 CS Lano pletené polypropylenové
 RO Coarda împletită din polipropilena
 HU Polipropilén fonott kötél
 ES Cuerda trenzada de polipropileno



No.	Ø [mm]	L [m]	
69521	4	20	50

EN Builders line
 PL Sznurek murarski
 DE Maurerschnur
 RU Шнур - причалка
 CS Šňůra zednická
 RO Sfoară pt. zidari
 HU Kőműves zsinór
 ES Cuerda de albañil



No.	Ø [mm]	L [m]	
17497	1.2	75	12/48

EN Builders line
 PL Sznurek murarski
 DE Maurerschnur
 RU Шнур - причалка
 CS Šňůra zednická
 RO Sfoară pt. zidari
 HU Kőműves zsinór
 ES Cuerda de albañil



No.	L [m]	Color / Kolor	
17488	50	žółty	60
17489	100	žółty	60

12

EN Polyethylene bricklayer's string
 PL Sznurek murarski polietylenowy
 DE Maurerschnur aus Polyäthylen
 RU Полиэтиленовый шнур каменщика
 CS Šňůra zednická polyetylenová
 RO Șnur de zidărie din polietilena
 HU Kőműves zsinór, polietilén
 ES Cordel de albañilería de polietileno



No.	Ø [mm]	L [m]	
17480	1.7	50	60/240
17481	1.7	100	30/120
17483	2.0	50	60/240
17484	2.0	100	30/120



EN Polypropylene sennit line
 PL Linka pleciona polipropylenowa
 DE Geflochtenes Seil aus Polypropylen
 RU Канат полипропиленовый плетеный

CS Lano pletené polypropylenové
 RO Coarda împletită din polipropilena
 HU Polipropilén fonott kötél
 ES Cuerda trenzada de polipropileno



No.	Ø [mm]	L [m]	
69502	4	400	1
69503	5	250	1
69504	6	250	1
69505	8	300	1
69506	10	200	1
69507	12	180	1
69508	14	110	1
69509	16	80	1
69510	18	70	1

EN String jute rope
 PL Lina jutowa skręcana
 DE Verdrihtt Seil aus Jute
 RU Канат джутовый

CS Lano jutová kroucená
 RO Cablu răsucit de iută
 HU Juta sodrott kötél
 ES Cable de yute torcido



No.	Ø [mm]	L [m]	
69572	10	10	20

EN Flax thread, twine
 PL Nici lniane, dratwa
 DE Leinentaden, Pechfaden
 RU Нить (дратва) льняная

CS Nítě lněné, dratev
 RO Fire de in, fire
 HU Len cérna, fonál
 ES Hilo de lino, cabo de zapatero



No.	m [g]	
69635	100	28
69637	250	18

EN Line blocks with brick lines
 PL Uchwyty kątowe do linki murarskiej
 DE Maurerschnur Spannklotze mit Richtschnur
 RU Строительные уголки для причального шнура
 CS Stavební rožky pro zednické provázky
 RO Dispozitiv pt. aliniere caramizi
 HU Építési rudak falazott húrokhoz
 ES Pareja de angulares para cuerda de albañil acha



No.	L [m]	
17430	18	48/96

EN Steel pins for fixing masonry lines / hd line pin
 PL Szpilki murarskie stalowe
 DE Maurerstifte aus Stahl
 RU Стальные шпильки для кладки
 CS Zednické hřebíky ocelové
 RO Cuie pt. fixare sfoara de trasat
 HU Falazósinór rögzítő szeg
 ES Pasadores de acero para mampostería

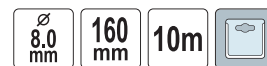

No.	Ø [mm]	L	
17435	8	160 mm (szpilki), 10 m (linka)	10/40

EN Universal PP sennit string
 PL Sznurek PP pleciony, uniwersalny
 DE PP-Schnur, geflochten, universell
 RU Шнур полипропиленовый

CS Šňůra PP pletená univerzální
 RO Șnur PP împletit, universal
 HU PP fonott kötél, univerzális
 ES Cordel trenzado universal PP



No.	Ø [mm]	L [m]	
69620	3	10	50
69621	3	20	40

EN Packing jute string
 PL Sznurek pakowy, jutowy
 DE Packschnur, aus Jute
 RU Шнур джутовый

CS Šňůra ucpávková jutová
 RO Șnur de împachetat, de iută
 HU Csomagkötöző spárga, juta
 ES Cordel de yute para embalaje



No.	m [g]	
69630	50	112
69631	100	100

EN Needle rope
 PL Lina igłowa
 DE Nadelseil
 RU Канат полипропиленовый, плетёный
 CS Lano s jádrem opletené
 RO Cablu ac
 HU Tűfonatos kótél
 ES Cable acalabrotado



VOREL

No.	Ø [mm]	L [m]	
69539	8	10	30
69540	8	20	20
69542	10	10	25
69543	10	20	15
69546	12	20	10

EN Elastic sennit line
 PL Linka pleciona, elastyczna
 DE Geflochtenes Seil, elastisch
 RU Канат плетёный эластичный
 CS Lano pletené elastické
 RO Coarda împletită, elastică
 HU Fonott kótél, rugalmas
 ES Cuerda trenzada elástica



VOREL

No.	Ø [mm]	L [m]	
69550	6	150	1
69551	8	100	1
69552	10	100	1

EN Brass plumb bob
 PL Pion murarski
 DE Senklot
 RU отвес строительный
 CS Zednická olovnice
 RO Fir pt. trasat cu greutate din alama
 HU Fűggőbón
 ES Plomada



VOREL

No.	Size / Rozmiar [mm]	L [m]	
17301	12x62	5	10/150

EN Brass plumb bob
 PL Pion murarski
 DE Senklot
 RU отвес строительный
 CS Zednická olovnice
 RO Fir pt. trasat cu greutate din alama
 HU Fűggőbón
 ES Plomada



VOREL

No.	Size / Rozmiar [mm]	L [m]	
17303	22x115	6	10/60

EN Spliced wire polypropylene string
 PL Sznurek PP do podwiązania wełny izolacyjnej
 DE Polypropylen Erntegar
 RU Шнур полипропиленовый
 CS Provázek polypropylenový
 RO Snur din polipropilena
 HU Spágat polypropylenový
 ES Cuerda



VOREL

No.	Ø [mm]	L [m]	
69608	2.5	200	100
69609	2.5	300	80
69610	2.5	450	50
69612	2.5	1000	24
69613	2.5	2000	12

EN Plumb bob
 PL Pion murarski
 DE Senklot
 RU отвес со шнуром
 CS Murařská centrace
 RO Fir cu plumb
 HU Kőműves függőbón
 ES Plomada albañil



No.	Size / Rozmiar [mm]	
17300	15x70	100

EN Brass plumb bob
 PL Pion murarski
 DE Senklot
 RU отвес строительный
 CS Zednická olovnice
 RO Fir pt. trasat cu greutate din alama
 HU Fűggőbón
 ES Plomada



VOREL

No.	Size / Rozmiar [mm]	L [m]	
17302	19x68	4.5	25/100

EN Brass plumb bob
 PL Pion murarski
 DE Senklot
 RU отвес строительный
 CS Zednická olovnice
 RO Fir pt. trasat cu greutate din alama
 HU Fűggőbón
 ES Plomada



VOREL

No.	Size / Rozmiar [mm]	L [m]	
17304	27x88	4.5	9/36

- EN Magnetic plumb
- PL Pion murarski z mocowaniem magnetycznym
- DE Senklot mit Haltemagnet
- RU Магнитный строительный отвес
- CS Olovnice se magnetu
- RO Fir cu plumb magnetic
- HU Fűggőbón
- ES Fios de prumo com íman

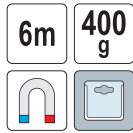

No.	L [m]	
17310	6	6/36

- EN Try square
- PL Kątownik stolarski
- DE Zimmermannswinkel
- RU Угольник столярный
- CS Truhlářský úhelník
- RO Echer (unghi drept) de tâmplărie
- HU Asztalos derékszög
- ES Escuadra de metal

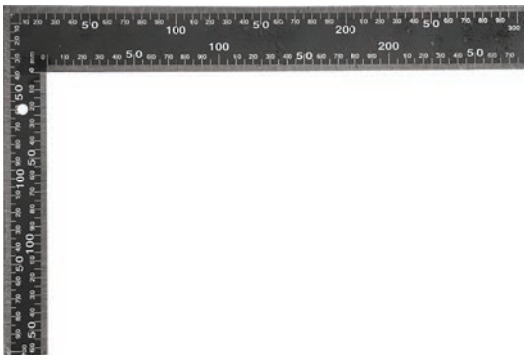

No.	Size / Rozmiar [mm]	
18201	200x300	24/48
18200	400x600	12/24

- EN Try square
- PL Kątownik metalowy ze stopką i libellą
- DE Metall-Anschlag-winkel mit Fuß und Libelle
- RU Металлический угольник с опорой и ампулой
- CS Kovový úhelník s nohou a vodováhou
- RO Echer
- HU Fém asztalos derékszög talppal és libellával
- ES Escuadra metálica con pie y nivel

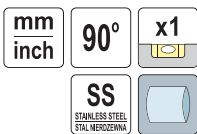

No.	L [mm]	
18380	150	10/60
18381	400	10/60
18382	700	10/60

- EN Try square
- PL Kątownik stolarski
- DE Zimmermannswinkel
- RU Угольник столярный
- CS Truhlářský úhelník
- RO Echer (unghi drept) de tâmplărie
- HU Asztalos derékszög
- ES Escuadra de metal



No.	L [mm]	
18250	250	12/120
18300	300	12/120
18350	350	12/120

- EN Aluminium try square
- PL Kątownik aluminiowy
- DE Alu-Zimmermannswinkel
- RU Угольник столярный алюминиевый
- CS Truhlářský úhelník
- RO Echer (unghi drept) de tâmplărie
- HU Asztalos derékszög
- ES Escuadra



No.	L [mm]	
18360	250	10/60
18361	300	10/60
18362	350	10/60

- EN Try square set
- PL Zestaw kątowników metalowych ze stopką i libellą
- DE Metall-Anschlagwinkel-Set mit Fuß und Libelle
- RU Комплект металлических уголков с ножкой и пузырьком
- CS Sada kovových úhelníků s nohou a vodováhou
- RO Set 3 echere
- HU Fém asztalos derékszög készlet talppal és libellával
- ES Juego de escuadras metálicas con pie y nivel

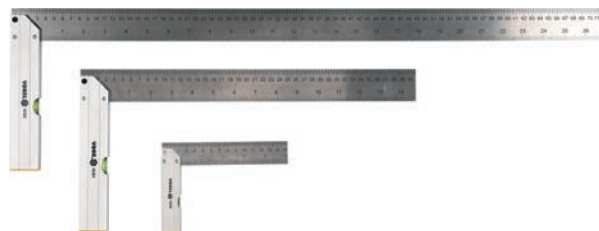

No.	L [mm]	
18390	150, 400, 700	25

- EN Angle bar with a support
 PL Kątownik z podpórką
 DE Winkel mit Stütze
 RU Угольник столярный с откидным упором
- CS Úhelník s dorazem
 RO Cornier cu stand
 HU Támaszos derékszögelő
 ES Escuadra con soporte



VOREL

No.	L [mm]	
18501	350	30
18502	500	30
18503	750	20
18504	1000	10

- EN Aluminium try square
 PL Kątownik aluminiowy
 DE Alu-Zimmermannswinkel
 RU Угольник столярный алюминиевый
 CS Truhlářský úhelník
 RO Echer (unghi drept) de tâmplărie
 HU Asztalos derékszög
 ES Escuadra de aluminio



VOREL

No.	Size / Rozmiar [mm]	
18374	600x320	6/12
18375	1200x600	6/12

- EN Bevel protractor
 PL Kątomierz nastawny
 DE Winkelmesser
 RU Угломер регулируемый со шкалой
 CS Nastavitelný úhloměr
 RO Echer reglabil
 HU Állítható szögmérő
 ES Calibrador de biseles



No.	L [mm]	
18797	350	10
18798	500	10
18799	750	10

- EN Aluminium try square
 PL Kątownik aluminiowy
 DE Alu-Zimmermannswinkel
 RU Угольник столярный алюминиевый
 CS Truhlářský úhelník
 RO Echer (unghi drept) de tâmplărie
 HU Asztalos derékszög
 ES Escuadra de aluminio

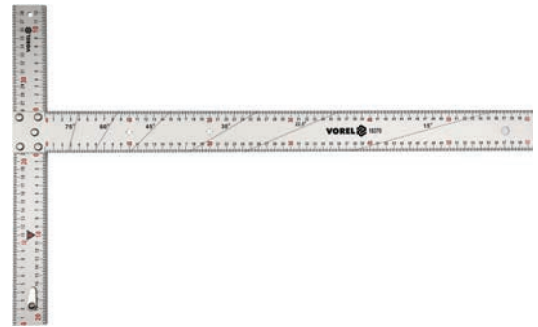

VOREL

No.	Size / Rozmiar [mm]	
18370	600x390	2/10
18372	1200x390	2/10

- EN Aluminium try square
 PL Kątownik aluminiowy
 DE Alu-Zimmermannswinkel
 RU Угольник столярный алюминиевый
 CS Truhlářský úhelník
 RO Echer de tâmplărie
 HU Asztalos derékszög
 ES Escuadra de aluminio



12

VOREL

No.	Size / Rozmiar [mm]	
18355	400x210	100
18356	600x210	60
18357	1000x210	60

- EN Protractor with level
 PL Kątomierz z libellą i ruchomym ramieniem
 DE Winkelmesser
 RU Транспортир
 CS Protractor
 RO Mușchi extensor
 HU Szögmerő
 ES Transportador



VOREL

No.	L [mm]	Vials / Libelle	
18473	250	1	10/60

- EN Protractor electronic with spirit level
- PL Kątomierz elektroniczny z poziomnicą
- DE Digital Winkelmesser mit Wasserwaage
- RU Транспортир электронный с уровнем
- CS Protractor electronic s urovni
- RO Protractor electronic level cu
- HU Szögmérő elektronikusak szint
- ES Con el nivel electrónico transportador

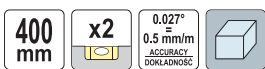

No.	L [mm]	Vials / Libelle	Icon
17570	400	2	20

- EN Bevel protractor
- PL Skośnica drewniana
- DE Schmiege
- RU Угольник регулируемый деревянный
- CS Nastavitelný úhloměr
- RO Echer reglabil
- HU Állítható szögmérő
- ES Calibrador de biselés



No.	L [mm]	Icon
18800	270	80
18810	400	60

- EN Triangle ruler
- PL Kątownik ciesielski do krokwi
- DE Lineal Winkelmesser
- RU Угольник для плотника и столяра
- CS Tesařský úhelník
- RO Echer pt. dulgherie
- HU Fém derékszög
- ES Escuadra

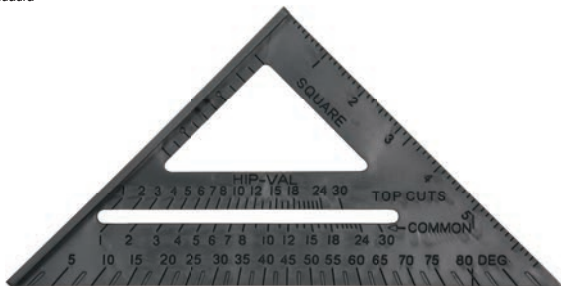

No.	L [mm]	Icon
18530	180	100

- EN Multipurpose angle finder
- PL Kątomierz budowlany
- DE Bauwinkelmesser
- RU Строительный угломер
- CS Stavební úhloměr
- RO Raportor multifunctional
- HU Építési szögmérő
- ES Escuadra de construcción

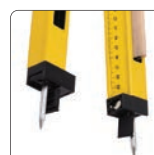
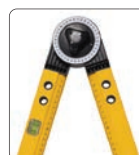

No.	L [mm]	Vials / Libelle	Icon
18790	500	2	10

- EN Adjustable ruler
- PL Kątownik nastawny do przenoszenia wymiarów
- DE Multifunktionales Messlineal
- RU Разметочный инструмент линейка-шаблон

- CS Pokosník nastavitelný
- RO Echer reglabil
- HU Szögmérőekék
- ES Medición del ángulo



No.	Icon
18470	20/60

- EN Aluminium triangle ruler with foot
- PL Kątownik aluminiowy ze stopką
- DE Aluminiumwinkel mit Fuß
- RU Алюминиевый угольник с основанием
- CS Hliníkový úhelník s patkou
- RO Echer aluminiu cu talpa
- HU Talpas alumínium derékszög
- ES Escuadra de aluminio con pie



No.	Dimensions / Wymiary [mm]	Icon
18377	180x180x250	12/120

- EN Foldable stainless steel ruler
- PL Liniał nierdzewny składany
- DE Gliedermaßstab aus Edelstahl
- RU Линейка из нержавеющей стали складная
- CS Skládací nerezové pravítko
- RO Rigla din oțel inoxidabil pliată
- HU Colostok
- ES Regla inoxidable plegable

600x0.8 mm mm inch SS410 STAINLESS STEEL STAŁ NIERDZEWNA

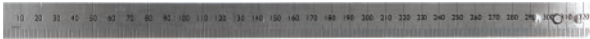

No.	L [mm]	
19740	600 (300 x2)	20/240

- EN Aluminium ruler, 2 vials
- PL Przymiar aluminiowy, uchwyty, 2 libelki
- DE Alu Zeichen-Masstab 2-lib
- RU Линейка столовая алюминиевая 2 глазка с ручкой
- CS Měřidlo hliníkové
- RO Rigla de aluminiu cu 2 bule
- HU Alumínium vonalzó
- ES Regla de aluminio, mango, division 2-burbujas

1000 mm x2 AI



No.	L [mm]	Vials / Libelle	
19755	1000	2	24

- EN Aluminium ruler
- PL Liniał aluminiowy
- DE Aluminium-Gliedermaß
- RU Алюминиевая линейка
- CS Hliníkové pravítko
- RO Rigla aluminiu
- HU Alumínium vonalzó
- ES Regla de aluminio

mm inch AI



No.	Dimensions / Wymiary [mm]	
19763	150x28x1.8	20/120
19765	300x28x1.8	20/120
19766	600x28x1.8	20/120
19767	1000x28x1.8	10/100

- EN Carpenter's ruler
- PL Przymiar do tapet
- DE Zeichen-Masstab
- RU Линейка стальная с деревянной ручкой

- CS Měřidlo stavební
- RO Rigla de tamplarie
- HU Kőműves vonalzó
- ES Regla de obra

750 mm



No.	L [mm]	
19750	750	10/40

- EN Aluminium ruler, 2 vials
- PL Przymiar aluminiowy, uchwyty, 2 libelki
- DE Alu Zeichen-Masstab 2-lib
- RU Линейка столовая алюминиевая 2 глазка с ручкой
- CS Měřidlo hliníkové
- RO Rigla de aluminiu cu 2 bule
- HU Alumínium vonalzó
- ES Regla de aluminio, mango, division 2-burbujas

600 mm x2 AI



No.	L [mm]	Vials / Libelle	
19770	600	2	12/24

- EN Laser distance meter
- PL Dalmierz laserowy
- DE Laserentfernungsmesser
- RU Лазерный дальномер
- CS Laserový měřič vzdálenosti
- RO Telemetru cu laser
- HU Lézeres távolságmérő
- ES Medidores láser de distancias

0.05-40 m +/- 2.0 mm x20 MEMORY PANEEC x8 MODES TRYBY

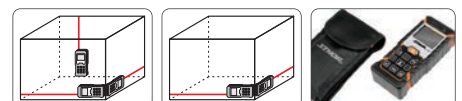
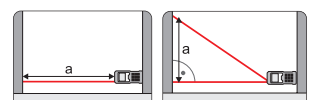

No.	
81790	20

EN Laser distance meter
 PL Dalmierz laserowy
 DE Laserentfernungsmesser
 RU Лазерный дальномер
 CS Laserový měřič vzdálenosti
 RO Telemetru cu laser
 HU Lézeres távolságmérő
 ES Medidores láser de distancias



50m	+/- 2.0 mm	
x10 MEMORY PAMIEC	x8 MODES TRYBY	MAX MIN
CONSTANT ANGLE PITCH MEASUREMENT CIĄGŁY POMIAR KĄTA NACHYLENIA	IP54	2x AAA

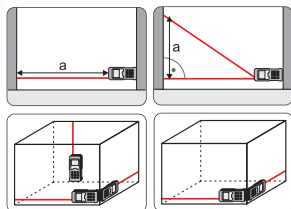

No.	
81791	10/50

EN Laser distance meter
 PL Dalmierz laserowy
 DE Laserentfernungsmesser
 RU Лазерный дальномер
 CS Laserový měřič vzdálenosti
 RO Telemetru cu laser
 HU Lézeres távolságmérő
 ES Medidores láser de distancias



80m	+/- 2.0 mm	
x10 MEMORY PAMIEC	x8 MODES TRYBY	MAX MIN
CONSTANT ANGLE PITCH MEASUREMENT CIĄGŁY POMIAR KĄTA NACHYLENIA	IP54	2x AAA

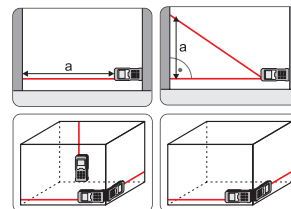

No.	
81794	10/50

EN Laser distance meter
 PL Dalmierz laserowy
 DE Laserentfernungsmesser
 RU Лазерный дальномер
 CS Laserový měřič vzdálenosti
 RO Telemetru cu laser
 HU Lézeres távolságmérő
 ES Medidores láser de distancias



100 m	+/- 2.0 mm	
x10 MEMORY PAMIEC	x8 MODES TRYBY	MAX MIN
CONSTANT ANGLE PITCH MEASUREMENT CIĄGŁY POMIAR KĄTA NACHYLENIA	IP54	2x AAA

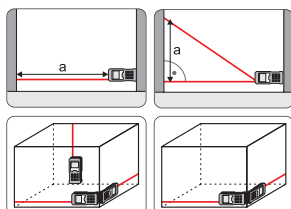

No.	
81795	10/50

EN Self-leveling cross line laser
 PL Laser krzyżowy samopoziomujący z uchwytem mocującym
 DE Selbstnivellierung Linienlaser
 RU Лазерный нивелир
 CS Křížový laser
 RO Laserul crossline level
 HU Keresztugaras lézeres
 ES Nivel láser cruzado



30m	± 2.0 mm / 10 m	± 3° SELF-REGULATION SAMOREGULACJA
635 nm	1/4" (6.3 mm) TRIPOD THREAD GWINT STATYWU	8h
°C -10 +40	CLASS I KLASA	IP54
	3x AA	



No.	
18000	12

EN Self-leveling cross line laser with 90° vertical line
 PL Laser krzyżowy samopoziomujący trójliniowy z uchwytem mocującym
 DE Selbstnivellierung 3-Linienlaser
 RU Лазерный нивелир
 CS Křížový laser
 RO Laserul crossline level
 HU Zöld keresztéizer
 ES Nivel láser cruzado



30m	± 4.0 mm / 10 m	635 nm
1/4" (6.3 mm) TRIPOD THREAD GWINT STATYWU	8h	IP54
	3x AAA	



No.	
18001	20

EN Cross line green laser
 PL Laser zielony krzyżowy
 DE Laser mit grünem Kreuz
 RU Лазерный уровень зеленый крест
 CS Laser zelený křížový
 RO Nivelă cu laser transversală
 HU Zöld keresztéizer
 ES Láser en cruz verde



± 3.0 mm / 10 m LASER NŐBŐRŐZŐ KONJANCIÓS LASER	± 4° SELF-REGULATION SAMOREGULACJA	510-530 nm
1/4" (6.3 mm) TRIPOD THREAD GWINT STATYWU	8h	°C -10 +50
≤ 1 mW	CLASS I KLASA	IP54
3V	2x AA	



No.	
18002	30

EN Aluminium tripod
 PL Statyw aluminiowy
 DE Aluminium-Stativ
 RU Алюминиевый штатив
 CS Hliníkový stativ
 RO Trepied aluminiu
 HU Alumínium állvány
 ES Trípode de aluminio



No.	H [mm]	
18021	250-500	12

EN Metal and voltage detector
 PL Wykrywacz metalu i przewodów
 DE Ortungsgerät für Metal und Leitungen
 RU Детектор металла и токоведущих проводов
 CS Detektor kovu a elektrických vodičů
 RO Detector metale si electricitate
 HU Fém- és feszültség detektor
 ES Detector de metalo y cables

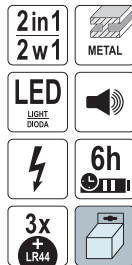

No.	
81786	10/80

EN Hygrometer
 PL Higrometr
 DE Hygrometer
 RU Гигрометр
 CS Hygrometr
 RO Higrometru
 HU Higrométer
 ES Higrómetro

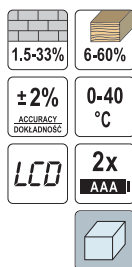

No.	
81751	72

EN Aluminium tripod
 PL Statyw aluminiowy
 DE Aluminium-Stativ
 RU Алюминиевый штатив
 CS Hliníkový stativ
 RO Trepied aluminiu
 HU Alumínium állvány
 ES Trípode de aluminio



No.	H [mm]	
18020	500-1500	12

EN Metal and voltage detector
 PL Wykrywacz metalu i przewodów
 DE Ortungsgerät für Metal und Leitungen
 RU Детектор металла и токоведущих проводов
 CS Detektor kovu a elektrických vodičů
 RO Detector metale si electricitate
 HU Fém- és feszültség detektor
 ES Detector de metalo y cables



No.	
81785	20

EN Infrared thermometer
 PL Pirometr
 DE Pyrometer
 RU Пирометр
 CS Pyrometr
 RO Termometru cu infrarosu
 HU Pírométer
 ES Pirómetro

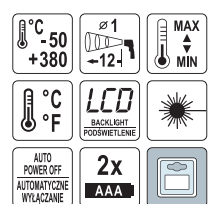

No.	
84400	20/80



- EN Paint thickness tester
- PL Tester grubości lakieru
- DE Lackdickenmessgerät
- RU Толщиномер лакокрасочного покрытия
- CS Tester tloušťky laku
- RO Tester de buzunar grosime vopsea
- HU Rétegvastagság mérő
- ES Medidor de espesor de recubrimiento



0-20 mm
±2% ACCURACY / DOKŁADNOŚĆ
ALUMINIUM ALUMINIUM
STEEL STAL



No.		
81731		40/80

- EN Torpedo level
- PL Poziomnica torpeda
- DE Wasserwaage torpedo
- RU Уровень духа торпедо
- CS Přesná vodováha torpédo
- RO Nivelă torpilă
- HU Vízmérték torpedó
- ES Nivel torpedo

230 mm
x3
0.027° = 0.5 mm/m ACCURACY / DOKŁADNOŚĆ



No.	L [mm]	Vials / Libelle	
16300	230	3	100

- EN Laser level mini
- PL Poziomnica laserowa mini
- DE Laser Wasserwaage mini
- RU Уровни лазерные мини
- CS Úrovňe laserové mini
- RO Niveluri mini cu laser
- HU Szintek lézer mini
- ES Niveles láser mini

0.057° = 1 mm/m ACCURACY / DOKŁADNOŚĆ
135-245 mm
5-40 °C



No.		
17560		20

- EN Aluminium level
- PL Poziomnica aluminiowa
- DE Wasserwaage
- RU Уровень
- CS Vodováha
- RO Cumpănă
- HU Vízmérték
- ES Nivel

No.	L [mm]	Vials / Libelle	
16340	400	3	20/60
16360	600	3	20/60
16380	800	3	20/60
16400	1000	3	20/60

- EN Trapezoidal spirit level
- PL Poziomnica trapezowa
- DE Trapezförmige Wasserwaage
- RU Трапецидальный уровень

- CS Vodováha trapezová
- RO Nivelă trapezoidală
- HU Vízmérték trapéz
- ES Trapezoides nivel

500 mm
x2
0.027° = 0.5 mm/m ACCURACY / DOKŁADNOŚĆ



No.	L [mm]	Vials / Libelle	
16280	500	2	50

- EN Torpedo level
- PL Poziomnica torpeda
- DE Wasserwaage torpedo
- RU Уровень духа торпедо
- CS Přesná vodováha torpédo
- RO Nivelă torpilă
- HU Vízmérték torpedó
- ES Nivel torpedo

230 mm
x3
0.027° = 0.5 mm/m ACCURACY / DOKŁADNOŚĆ



No.	L [mm]	Vials / Libelle	
16301	230	3	100

- EN Post level
- PL Poziomnica do słupków
- DE Pfostenwasserwaage
- RU Уровни на должности
- CS Hladiny do míst
- RO Niveluri de către posturile
- HU Szintek üzenete
- ES Los niveles a los mensajes

x3
ABS



No.	Vials / Libelle	
16012	3	25/100



EN Aluminium level
 PL Poziomnica aluminiowa
 DE Wasserwaage
 RU Уровень
 CS Vodováha
 RO Cumpănă
 HU Vízmerő
 ES Nivel



No.	L [mm]	Vials / Libelle	
16551	400	3	25/50
16552	600	3	25/50
16553	800	3	25/50
16554	1000	3	25/50
16555	1200	3	15/30
16556	1500	3	15/30
16557	2000	3	10/20

EN Water level
 PL Poziomnica wodna z węzłem
 DE Schlauchwaage
 RU Гидроуровень
 CS Vodná vodováha
 RO Furtun de nivel
 HU Vizes vízmerő
 ES Nivel de agua



No.	L [mm]	Ø [mm]	
16000	15	10	15
16001	20	10	15
16002	25	10	15

EN Spring weight measurer
 PL Waga sprężynowa z miarką zwijaną
 DE Federwaage
 RU Ручные пружинные весы
 CS Váha pětová
 RO Cântar cu arc și cârlig
 HU Akasztós mérleg
 ES Balanza de resorte

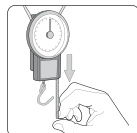
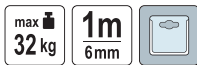

No.	Max. lifting capacity / Maks. udźwig [kg]	
15301	32	36

EN Aluminium level
 PL Poziomnica aluminiowa
 DE Wasserwaage
 RU Уровень
 CS Vodováha
 RO Cumpănă
 HU Vízmerő
 ES Nivel



No.	L [mm]	Vials / Libelle	
17606	600	3	20/60
17608	800	3	20/60
17610	1000	3	20/60
17612	1200	3	15/30
17615	1500	3	15/30
17620	2000	3	10/20

EN Spring weight measurer
 PL Waga sprężynowa
 DE Federwaage
 RU Ручные пружинные весы
 CS Váha pětová
 RO Cântar cu arc și cârlig
 HU Akasztós mérleg
 ES Balanza de resorte



No.	Max. lifting capacity / Maks. udźwig [kg]	
15291	25	72
15292	50	48

EN Head magnifier
 PL Lupa z opaską na głowę
 DE Lupe mit Stirband
 RU Лупа биноклярная налобная
 CS Lupa s hlavou
 RO Lupă cu cap
 HU Fejpántos nagyító szett
 ES Lupa con cabeza



No.	
73503	24

13

Pneumatic tools Narzędzia pneumatyczne



Air tools
Narzędzia pneumatyczne

208-211



Impact wrenches Klucze udarowe.....	208
Pneumatic grinders Szlifierki pneumatyczne.....	208
Pneumatic ratchets Grzechotki pneumatyczne.....	209
Pneumatic hammers Młotki pneumatyczne.....	210
Pneumatic cut-off tools Przecinarki pneumatyczne.....	210
Pneumatic shears Nożyce pneumatyczne.....	210
Pneumatic drills Wiertarki pneumatyczne.....	211
Multi-purpose air tools Wielofunkcyjne narzędzia pneumatyczne.....	211

Tire inflating guns & heads
Pistolety do pompowania kół i głowice

211-212

Pneumatic painting equipment
Narzędzia do malowania

212-214



Spray guns Pistolety lakiernicze.....	212
Blow guns Pistolety do przedmuchiwania.....	213
Washing guns Pistolety do ropowania.....	214

Pneumatic accessories
Aksesoria instalacji pneumatycznej

214-216



Air filters, regulators & lubricators Filtry, reduktory i smarownice.....	214
Spiral hoses Węże spiralne.....	215
Reinforced hoses Węże zbrojone.....	215
Couplers Złącza.....	215



Pneumatic riveters
Nitownice pneumatyczne

216



- EN Impact wrench
- PL Klucz pneumatyczny
- DE Druckluft-Schlagschrauber
- RU Ударный пневматический гаикверт
- CS Klíč pneumatický
- RO Pistol pneumatic
- HU Pneumatikus ütvecsavarozó
- ES Llave neumática de percusión

1/2" 12.7mm
0.63 MPa
0-7000 min⁻¹
226 l/min
340 Nm





$L_{pa} = 92,6 \text{ dB}$; $L_{wa} = 103,6 \text{ dB}$; $a_n = 2,8 \text{ m/s}^2$

No.	Ø	Required air flow / Wymagany przepływ powietrza [l/min]	Max. torque / Maks. moment obrotowy [Nm]	
81100	1/2" (12.5 mm)	226	340	10

- EN Air grinder
- PL Szlifierka pneumatyczna prosta
- DE Drucklufteinhandschleifer
- RU Шлифмашинка пневматическая
- CS Bruska přímá pneumatická
- RO Polizor pneumatic
- HU Pneumatikus egyenescsiszoló
- ES Lijadora neumática recta

0.63 MPa
25000 min⁻¹
100 l/min

6 mm







$L_{pa} = 88,0 \pm 3,0 \text{ dB}$; $L_{wa} = 99,0 \pm 3,0 \text{ dB}$; $a_n = 2,9 \pm 1,5 \text{ m/s}^2$

No.	Toolholder size / Rozmiar uchwyty narzędziowego	Required air flow / Wymagany przepływ powietrza [l/min]	Ω [min ⁻¹]	
81107	1/4" (6.3 mm)	100	25000	20

- EN Air angle grinder
- PL Szlifierka pneumatyczna kątowna
- DE Ruckluft-Winkelschleifer
- RU Пневматическая угловая шлифовальная машина
- CS Pneumatické úhlovou brusku
- RO Polizor unghiular pneumatic
- HU Pneumatikus sarokcsiszoló
- ES Amoladora angular neumática

0.63 MPa
0-20000 min⁻¹
100 l/min

6 mm







$L_{pa} = 90,1 \text{ dB}$; $L_{wa} = 101,1 \text{ dB}$; $a_n = 0,7 \text{ m/s}^2$

No.	Toolholder size / Rozmiar uchwyty narzędziowego	Required air flow / Wymagany przepływ powietrza [l/min]	Ω [min ⁻¹]	
81110	1/4" (6.3 mm)	100	0-20000	16

- EN Air impact kit
- PL Klucz pneumatyczny z nasadkami
- DE Druckluft-Schlagschrauber mit Krafteinsätzen
- RU Гаикверт пневматический с набором головок
- CS Klíč pneumatický s nástavci
- RO Pistol pneumatic cu accesorii
- HU Pneumatikus ütvecsavarozó készlet
- ES Llave neumática de percusión

1/2" 12.7mm
0.63 MPa
0-7000 min⁻¹
226 l/min

340 Nm
CrV







$L_{pa} = 95,0 \pm 3,0 \text{ dB}$; $L_{wa} = 106,0 \pm 3,0 \text{ dB}$; $a_n = 9,1 \pm 1,5 \text{ m/s}^2$

No.	Ø	Required air flow / Wymagany przepływ powietrza [l/min]	Max. torque / Maks. moment obrotowy [Nm]	
81101	1/2" (12.5 mm)	226	340	5

- EN Air grinder
- PL Szlifierka pneumatyczna prosta
- DE Drucklufteinhandschleifer
- RU Шлифмашинка пневматическая
- CS Bruska přímá pneumatická
- RO Polizor pneumatic
- HU Pneumatikus egyenescsiszoló
- ES Lijadora neumática recta

0.63 MPa
0-22000 min⁻¹
127 l/min

6 mm







$L_{pa} = 82,8 \text{ dB}$; $L_{wa} = 93,8 \text{ dB}$; $a_n = 0,9 \text{ m/s}^2$

No.	Toolholder size / Rozmiar uchwyty narzędziowego	Required air flow / Wymagany przepływ powietrza [l/min]	Ω [min ⁻¹]	
81108	1/4" (6.3 mm)	127	0-22000	20

- EN Die grinder kit
- PL Szlifierka pneumatyczna prosta z akcesoriami
- DE Druckluft-Schrauber mit Schleifaufsätzen
- RU Прямая пневматическая шлифмашинка и принадлежности
- CS Bruska přímá pneumatická s příslušenstvím
- RO Masina de polizat pneumatica
- HU Pneumatikus kőszőrű készlet
- ES Lijadora neumática recta

10 PCS
0.63 MPa
0-22000 min⁻¹
127 l/min

3.6 mm





$L_{pa} = 88,0 \pm 3,0 \text{ dB}$; $L_{wa} = 99,0 \pm 3,0 \text{ dB}$; $a_n = 2,9 \pm 1,5 \text{ m/s}^2$

No.	Toolholder size / Rozmiar uchwyty narzędziowego	Required air flow / Wymagany przepływ powietrza [l/min]	Ω [min ⁻¹]	
81109	3 mm, 1/4" (6.3 mm)	127	0-22000	8

- EN Air micro die grinder kit
- PL Zestaw pneumatyczny szlifierka mini
- DE Luft Sterben Schleifer Kit
- RU Пневмошлифмашина мини в наборе
- CS Pneumatická bruska mini
- RO Biax pneumatic tip stiliou
- HU Pneumatikus mini-csiszoló
- ES Amoladora biax recta neumática

16 PCS	0.63 MPa	0-54000 min ⁻¹	
MINI OILER SMAROWNICA	OIL POT OLIVMARKA		

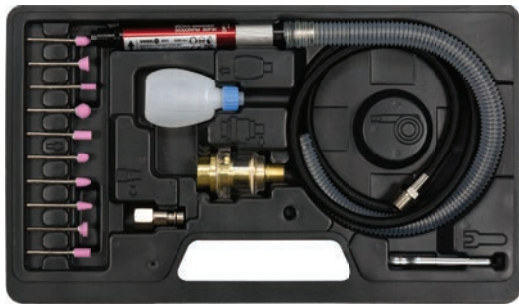

$L_{pA} = 79,0 \pm 3,0$ dB; $L_{wA} = 90,0 \pm 3,0$ dB; $a_n = <2,5$ m/s²

No.	Toolholder size / Rozmiar uchwyty narzędziowego [mm]	Ω [min ⁻¹]	
80970	3	0-54000	10

- EN Air sander
- PL Szlifierka pneumatyczna mimośrodowa
- DE Druckluft- Excenterschleifer
- RU Эксцентриковая шлифмашина
- CS Bruska pneumatická
- RO Masina de slefuit pneumatica
- HU Pneumatikus sarokcsiszológép
- ES Lijadora neumática excéntrica

0.63 MPa	0-10000 min ⁻¹	113 l/min	
150 mm			



$L_{pA} = 72,7$ dB; $L_{wA} = 83,7$ dB; $a_n = 1,44$ m/s²

No.	Disc diameter / Średnica tarczy [mm]	Ω [min ⁻¹]	
81114	150	0-10000	10

- EN Ratchet air wrench
- PL Grzechotka pneumatyczna
- DE Druckluft-Ratschenschrauber
- RU Пневмотрещотка
- CS Pneumatická ráčna
- RO Antrenor pneumatic
- HU Préslevegős behajtó szerszám
- ES Carraca neumática

1/4" 6.3mm	0.65 MPa (max)	150 min ⁻¹	113 l/min	
33 Nm				



$L_{pA} = 95,0 \pm 3,0$ dB; $L_{wA} = 106,0 \pm 3,0$ dB; $a_n = 9,2 \pm 1,5$ m/s²

No.	Ω	Required air flow / Wymagany przepływ powietrza [l/min]	Max. torque / Maks. moment obrotowy [Nm]	
81137	1/4" (6.3 mm)	113	33	20

- EN Straight line air sander
- PL Szlifierka pneumatyczna linialowa
- DE Druckluft-Linearschleifer
- RU Пневматическая прямошлифовальная машина
- CS Pneumatická bruska přimočará
- RO Slefuitor pneumatic
- HU Egyenes vonalú pneumatikus csiszoló
- ES Amoladora neumática lineal

0.63 MPa (max)	170 l/min	2500 min ⁻¹	
70x395 mm			



$L_{pA} = 79,1 \pm 3,0$ dB; $L_{wA} = 90,1 \pm 3,0$ dB; $a_n = 4,721 \pm 1,5$ m/s²

No.	Required air flow / Wymagany przepływ powietrza [l/min]	Work speed without load / Predkość pracy bez obciążenia [min ⁻¹]	
81150	170	2500	6

- EN Disc for air sander
- PL Tarcza polerska do szlifierki pneumatycznej
- DE Stützteller für Druckluftexcenterschleifer
- RU Диск для эксцентриковой шлифмашины
- CS Disk pro pneumatickou brusku
- RO Masina disc pt. slefuit
- HU Csiszolókorong pneumatikus gépekhez
- ES Recambio disco lijadora orbital neumática

150 mm	0-10000 min ⁻¹	M8	
------------------	-------------------------------------	-----------	--



No.	Ω [mm]	Ω [min ⁻¹]	
81115	150	0-10000	10/100

- EN Ratchet air wrench
- PL Grzechotka pneumatyczna
- DE Druckluft-Ratschenschrauber
- RU Пневмотрещотка
- CS Pneumatická ráčna
- RO Antrenor pneumatic
- HU Préslevegős behajtó szerszám
- ES Carraca neumática

1/2" 12.7mm	0.63 MPa	0-150 min ⁻¹	
141 l/min	61 Nm		



$L_{pA} = 92,1$ dB; $L_{wA} = 103,1$ dB; $a_n = 0,8$ m/s²

No.	Ω	Required air flow / Wymagany przepływ powietrza [l/min]	Max. torque / Maks. moment obrotowy [Nm]	
81117	1/2" (12.5 mm)	141	61	20

EN Ratchet air wrench
 PL Grzechotka pneumatyczna
 DE Druckluft-Ratschenschrauber
 RU Пневмотрещотка
 CS Pneumatická ráčna
 RO Antrenor pneumatic
 HU Préslevegős behajtó szerszám
 ES Carraca neumática

1/2"
12.7mm

0.63
MPa

0-160
min⁻¹

141
l/min

68
Nm

STANDARD



$L_{pa} = 91,0 \pm 3,0$ dB; $L_{wa} = 102,0 \pm 3,0$ dB; $a_n = 3,27 \pm 1,5$ m/s²

No.	Ø	Required air flow / Wymagany przepływ powietrza [l/min]	Max. torque / Maks. moment obrotowy [Nm]	Icon
81118	1/2" (12.7 mm)	141	68	10

EN Air hammer
 PL Młotek pneumatyczny
 DE Druckluft-Schlaghammer
 RU Пневматический молоток
 CS Sekáč vzduchový
 RO Pneumatikus vésőkészlet pisztolyal
 HU Kládívo pneumatické
 ES Marteau burineur

0.63
MPa

113
l/min

T
4500
min⁻¹

STANDARD



$L_{pa} = 85,0 \pm 3,0$ dB; $L_{wa} = 96,0 \pm 3,0$ dB; $a_n = 9,4 \pm 1,5$ m/s²

No.	Required air flow / Wymagany przepływ powietrza [l/min]	Icon
81133	113	8

EN Air nibbler
 PL Nożyce pneumatyczne matrycowe
 DE Pneumatische Schere
 RU Вырубные ножницы пневматические
 CS Pneumatické nůžky na plech
 RO Foarfece pneumatice
 HU Pneumatikus folyamatos lyukasztó
 ES Roedora neumática

0.62
MPa

113
l/min

3500
min⁻¹

5.5
mm

max
1.5mm
STEEL
STAL

STANDARD



$L_{pa} = 77,0 \pm 3,0$ dB; $L_{wa} = 88,0 \pm 3,0$ dB; $a_n = 4,42 \pm 1,5$ m/s²

No.	Required air flow / Wymagany przepływ powietrza [l/min]	Cutting speed / Prędkość cięcia [min ⁻¹]	Icon
81070	113	3500	20

EN Ratchet air wrench
 PL Grzechotka pneumatyczna
 DE Druckluft-Ratschenschrauber
 RU Пневмотрещотка
 CS Pneumatická ráčna
 RO Antrenor pneumatic
 HU Préslevegős behajtó szerszám
 ES Carraca neumática

1/2"
12.7mm

0.63
MPa

160
min⁻¹

113
l/min

69
Nm

STANDARD



$L_{pa} = 94,0 \pm 3,0$ dB; $L_{wa} = 105,0 \pm 3,0$ dB; $a_n = 9,0 \pm 1,5$ m/s²

No.	Ø	Required air flow / Wymagany przepływ powietrza [l/min]	Max. torque / Maks. moment obrotowy [Nm]	Icon
81119	1/2" (12.7 mm)	113	69	10

EN Air cut-off tool
 PL Przecinarka pneumatyczna
 DE Druckluft-Schneidmaschine
 RU Резак пневматический
 CS Pfičná bruska pneumatická
 RO Masina de taiat cu aer comprimat
 HU Pneumatikus sarokcsiszoló
 ES Cortadora neumática

0.62
MPa

113
l/min

75x9.5
mm

20000
min⁻¹

STANDARD



$L_{pa} = 84,5 \pm 3,0$ dB; $L_{wa} = 95,5 \pm 3,0$ dB; $a_n = 2,45 \pm 1,5$ m/s²

No.	Required air flow / Wymagany przepływ powietrza [l/min]	Ø [min ⁻¹]	Icon
81080	113	20000	20

EN Air shears pistol type
 PL Nożyce pneumatyczne kątowe
 DE Pneumatische Schere
 RU Пневматические ножницы угловые
 CS Pneumatické nůžky na plech
 RO Foarfece pneumatice
 HU Pneumatikus ollók
 ES Tijera neumática

0.62
MPa

184
l/min

3000
min⁻¹

5.5
mm

max
1.2mm
STEEL
STAL

max
1.4mm
Al





STANDARD



$L_{pa} = 77,0 \pm 3,0$ dB; $L_{wa} = 88,0 \pm 3,0$ dB; $a_n = 4,42 \pm 1,5$ m/s²

No.	Required air flow / Wymagany przepływ powietrza [l/min]	Cutting speed / Prędkość cięcia [min ⁻¹]	Icon
81072	184	3000	12

EN Air shears pistol type
 PL Nożyce pneumatyczne kątowe
 DE Pneumatische Schere
 RU Пневматические ножницы угловые
 CS Pneumatické nůžky na plech
 RO Foarfeca pneumatica
 HU Pneumatikus ollók
 ES Tijera neumática



0.62 MPa	184 l/min	 2100 min ⁻¹	 5.5 mm
max 1.2 mm STEEL STAL	max 1.4 mm Al	 STANDARD	



$L_{pa} = 77,0 \pm 3,0$ dB; $L_{wa} = 88,0 \pm 3,0$ dB; $a_n = 4,42 \pm 1,5$ m/s²

No.	Required air flow / Wymagany przepływ powietrza [l/min]	Cutting speed / Prędkość cięcia [min ⁻¹]	
81073	184	2100	10

EN Multi-purpose oscillating air tool
 PL Wielofunkcyjne narzędzie oscylacyjne pneumatyczne
 DE Druckluft-Multifunktionswerkzeuge
 RU Пневматический многофункциональный инструмент
 CS Pneumatická oscilační multifunkční bruska
 RO Multifuncțional oscilant pneumatic
 HU Légszersámok kétfélek multifunkciós csiszoló
 ES Estuche herramienta neumática multifunción



0.62 MPa	170 l/min	 18000 min ⁻¹
 STANDARD		



$L_{pa} = 87,5 \pm 3,0$ dB; $L_{wa} = 98,5 \pm 3,0$ dB; $a_n = 4,511 \pm 1,5$ m/s²

No.	Required air flow / Wymagany przepływ powietrza [l/min]	Ω [min ⁻¹]	
81060	170	18000	10

EN Inflating gun
 PL Pistolet do pompowania
 DE Inflatorpistole
 RU Пистолет для накачивания
 CS Pistolet na čerpání z manometrem
 RO Pistol cu manometru
 HU Pumpáló pisztoly nyomásmérővel
 ES Pistola de bombeo con manometro



1.2 MPa (max.)
 STANDARD



$L_{pa} = <70$ dB; $a_n = <2,5$ m/s²

No.	
81650	10/40

EN Reversible air drill
 PL Wiertarka pneumatyczna
 DE Druckluft-Bohrmaschine
 RU Пневматическая дрель
 CS Vrtačka ruční vzduchová
 RO Masina de gaurit pneumatica mandrina
 HU Pneumatikus fúró
 ES Taladradora neumática

0.62 MPa	113 l/min	 1800 min ⁻¹
 STANDARD		



$L_{pa} = 94,2 \pm 3,0$ dB; $L_{wa} = 105,2 \pm 3,0$ dB; $a_n = 2,14 \pm 1,5$ m/s²

No.	Required air flow / Wymagany przepływ powietrza [l/min]	Ω [min ⁻¹]	
81122	113	1800	10

EN Pneumatic tool set
 PL Zestaw narzędzi pneumatycznych z akcesoriami
 DE Druckluftwerkzeugsatz mit Zubehör
 RU Пневматический ударный инструмент в наборе
 CS Sada pneumatického nářadí
 RO Set pistol cu accesorii pneumatice
 HU Légszersámok készlet
 ES Juego de herramientas neumáticas con accesorios

1/2" 12.7 mm	0.63 MPa	CrV	6 mm 
 STANDARD			



No.	Ω	Toolholder size / Rozmiar uchwytu narzędziowego	pcs / szt.	
81142	1/2" (12.5 mm)	1/4" (6.3 mm)	33	2

EN Inflating gun
 PL Pistolet do pompowania
 DE Inflatorpistole
 RU Пистолет для накачивания
 CS Pistolet na čerpání z manometrem
 RO Pistol cu manometru
 HU Pumpáló pisztoly nyomásmérővel
 ES Pistola de bombeo con manometro

0.6 MPa (max.)
 STANDARD



$L_{pa} = 88,0 \pm 3,0$ dB; $L_{wa} = 99,0 \pm 3,0$ dB; $a_n = <2,5$ m/s²

No.	
81651	30

- EN Inflating head
 PL Glowica do pompowania
 DE Klemmnippel (universal)
 RU Насадка на насос под шланг
- CS Hlava na čerpání
 RO Cap pt. pompat
 HU Pumpafej
 ES Cabezal de bombeo

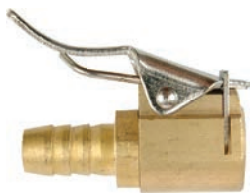

No.	Connector diameter / Šrednica krócca [mm]	
81653	8	50/300
81661	6	50/300

- EN Spray gun with fluid cup
 PL Pistolet natryskowy
 DE Lackierpistole mit Fließbecher
 RU Пистолет-распылитель с бачком
 CS Pistole na lakování z nádrží
 RO Pistol de vopsit cu rezervor
 HU Festékszóró pisztoly
 ES Pistola de barniz



$L_{pa} = 58,2 \text{ dB}$; $L_{wa} = 69,2 \text{ dB}$



No.	Nozzle diameter / Šrednica dyszy [mm]	
80902	1.4	10

- EN Spray gun with fluid cup
 PL Pistolet natryskowy
 DE Lackierpistole mit Fließbecher
 RU Краскораспылитель верхний бак
 CS Pistole na lakování z nádrží
 RO Pistol de vopsit cu rezervor inferior
 HU Festőpisztoly alsó tartállyal
 ES Pistola de barniz

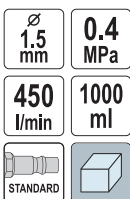

$L_{pa} < 70 \text{ dB}$; $a_n < 2.5 \text{ m/s}^2$



No.	Nozzle diameter / Šrednica dyszy [mm]	
81617	1.5	20

- EN Spray gun with fluid cup
 PL Pistolet natryskowy
 DE Lackierpistole mit Fließbecher
 RU Пистолет-распылитель с бачком
 CS Pistole na lakování z nádrží
 RO Pistol de vopsit cu rezervor
 HU Festékszóró pisztoly
 ES Pistola de barniz

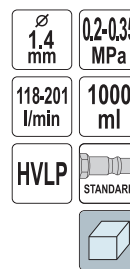

$L_{pa} = 61,2 \text{ dB}$; $L_{wa} = 72,2 \text{ dB}$



No.	Nozzle diameter / Šrednica dyszy [mm]	
80901	1.4	10

- EN Spray gun with fluid cup
 PL Pistolet natryskowy
 DE Lackierpistole mit Fließbecher
 RU Пистолет-распылитель с бачком
 CS Pistole na lakování z nádrží
 RO Pistol de vopsit cu rezervor
 HU Festékszóró pisztoly
 ES Pistola de barniz

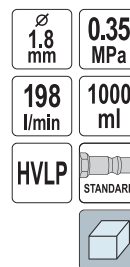

$L_{pa} = 85,0 \pm 2,5 \text{ dB}$; $L_{wa} = 98,9 \pm 2,5 \text{ dB}$



No.	Nozzle diameter / Šrednica dyszy [mm]	
80903	1.8	10

- EN Spray gun with fluid cup
 PL Pistolet natryskowy
 DE Lackierpistole mit Fließbecher
 RU Краскораспылитель верхний бак
 CS Pistole na lakování z nádrží
 RO Pistol de vopsit cu rezervor inferior
 HU Festőpisztoly alsó tartállyal
 ES Pistola de barniz

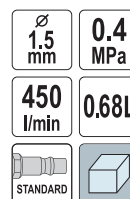

$L_{pa} < 70 \text{ dB}$; $a_n < 2,5 \text{ m/s}^2$



No.	Nozzle diameter / Šrednica dyszy [mm]	
81618	1.5	20

EN Spray gun kit
 PL Zestaw lakierniczy
 DE Lackierspritzsatz
 RU Набор покрасочный пневматический
 CS Laková souprava
 RO Set de lacuit
 HU Részes fényezőkészlet
 ES Juego de barniz

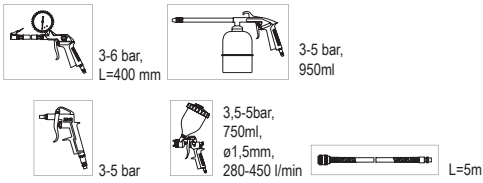

No.	pcs / szt.	
81638	5	10

EN Blow gun
 PL Pistolet do przedmuchiwania
 DE Ausblaspistole
 RU Пистолет для продувки короткий
 CS Pistolet na profukování kratká
 RO Pistol scurt pt. suflat
 HU Pövid előléfűvő pisztoly
 ES Pistola de soplado

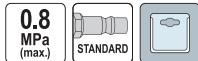

$L_{pa} = 91,0 \pm 3,0$ dB; $L_{wa} = 102,0 \pm 3,0$ dB; $a_h = <2,5$ m/s²

No.	Nozzle pipe length / Długość dyszy [mm]	
81631	100	10/40

EN Blow gun
 PL Pistolet do przedmuchiwania
 DE Ausblaspistole
 RU Пистолет для продувки короткий
 CS Pistolet na profukování kratká
 RO Pistol scurt pt. suflat
 HU Pövid előléfűvő pisztoly
 ES Pistola de soplado

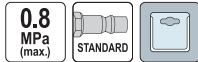

$L_{pa} = 91,0 \pm 3,0$ dB; $L_{wa} = 102,0 \pm 3,0$ dB; $a_h = <2,5$ m/s²

No.	Nozzle pipe length / Długość dyszy [mm]	
81633	300	10/40

EN Blow gun
 PL Pistolet do przedmuchiwania z przedłużką
 DE Gebläsepistole mit Verlängerung
 RU Пистолет для продувки длинный
 CS Pistolet na profukování dlouhá
 RO Pistol lung pt. suflat
 HU Rövid előléfűvő pisztoly
 ES Pistola de soplado

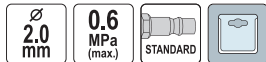

$L_{wa} = <70$ dB; $a_h = <2,5$ m/s²

No.		
81643		100

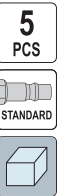

EN Blow gun
 PL Pistolet do przedmuchiwania
 DE Ausblaspistole
 RU Пистолет для продувки короткий
 CS Pistolet na profukování kratká
 RO Pistol scurt pt. suflat
 HU Pövid előléfűvő pisztoly
 ES Pistola de soplado



$L_{pa} = 91,0 \pm 3,0$ dB; $L_{wa} = 102,0 \pm 3,0$ dB; $a_h = <2,5$ m/s²

No.	Nozzle pipe length / Długość dyszy [mm]	
81632	200	10/40

EN Blow gun
 PL Pistolet do przedmuchiwania
 DE Ausblaspistole
 RU Пистолет для продувки короткий
 CS Pistolet na profukování kratká
 RO Pistol scurt pt. suflat
 HU Pövid előléfűvő pisztoly
 ES Pistola de soplado



$L_{wa} = <70$ dB; $a_h = <2,5$ m/s²

No.		
81640		20/40

EN Blow gun with extension
 PL Pistolet do przedmuchiwania z przedłużką
 DE Gebläsepistole mit Verlängerung
 RU Пистолет для продувки длинный
 CS Pistolet na profukování dlouhá
 RO Pistol lung pt. suflat
 HU Rövid előléfűvő pisztoly
 ES Pistola de soplado



$L_{wa} = <70$ dB; $a_h = <2,5$ m/s²

No.		
81644		20/40

- EN Air blow gun kit
- PL Zestaw do przedmuchiwania
- DE Ausblaspistole Druckluft Set
- RU Набор для продувки
- CS Pneumatická čistící pistole sada
- RO Pistol aer curatat praful cu furtun
- HU Fuvató pisztoly szett
- ES Kit pistola de aire aire bobina



$L_{pA} = 90,0 \text{ dB}$; $L_{wA} = 101,0 \text{ dB}$; $a_n = <2,5 \text{ m/s}^2$



No.		
81634		10/20

- EN Filter
- PL Filtr
- DE Filter
- RU Минифильтр
- CS Filtr
- RO Minifiltru
- HU Szűrő
- ES Filtro



No.	Thread size / Rozmiar gwintu	
81560	G1/4	10/50

- EN Pressure reducing valve with manometer
- PL Reduktor ciśnienia z manometrem
- DE Druckminderer mit Manometer
- RU Клапан уменьшения давления с манометром
- CS Redukční ventil s manometrem
- RO Valva cu reduciepresiune + manometru
- HU Nyomáscsökkentő szelep nyomásmérővel
- ES Reductor + manometro



No.	Thread size / Rozmiar gwintu	
81562	G3/8	50

- EN Air filter regulator and lubricator
- PL Zespół filtrujący, reduktor + smarownica
- DE Druckfilter - Druckminderer + Entöler
- RU Фильтр-редуктор + смазочный прибор
- CS Redukční ventil s odlučovačem oleje
- RO Filtru cu reductor
- HU Levegőelőkészítő
- ES Juego de filtro, reductor + engrasador



No.	Thread size / Rozmiar gwintu	
81556	G1/2	20

- EN Washing gun
- PL Pistolet do ropowania
- DE Waschpistole
- RU Пистолет для нефтewания
- CS Pistole na ropování
- RO Pistol (dozator) pt. motorină
- HU Olajpíisztoly
- ES Pistola de petroleár



$L_{wA} = <70 \text{ dB}$; $a_n = <2,5 \text{ m/s}^2$



No.		
81647		10/20

- EN In-line air tool oiler
- PL Naolejacz do narzędzi pneumatycznych
- DE Öler für Druckluftwerkzeuge
- RU Масленка для пневматического инструмента
- CS Olejníčka do pneumatických nářadí
- RO Gresor scule pneumatice
- HU Pneumatikus szerszám olajozó
- ES Lubricador para herramientas neumáticas

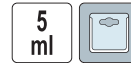

No.		
81570		20/100

- EN Filter - reductor
- PL Filtr - reduktor
- DE Druckfilter - Druckminderer
- RU Фильтр - редуктор
- CS Filtr redukční ventil
- RO Filtru cu reductor
- HU Szűrő - nyomáscsökkentő
- ES Reductor - filtro

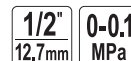
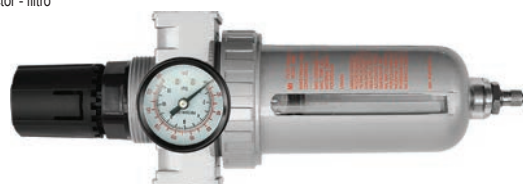

No.	Thread size / Rozmiar gwintu	
81553	G1/2	20

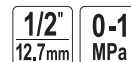

EN PE spiral tubes with rapid couplings
 PL Wąż spiralny PE z szybkozłączami
 DE Spiralschlauch mit Schnellkupplung
 RU Шланг спиральный с быстроразъемным соединением
 CS Spirální hadice
 RO Furtun în spirală
 HU Spiráltömlő
 ES Manguera espiral

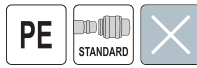

No.	Internal diameter / Średnica wewnętrzna [mm]	External diameter / Średnica zewnętrzna [mm]	L [m]	
81490	5	8	5	50
81491	5	8	10	25
81492	5	8	15	25

EN PU spiral tubes with rapid couplings
 PL Wąż spiralny PU z szybkozłączami
 DE Spiralschlauch mit Schnellkupplung
 RU Шланг спиральный с быстроразъемным соединением
 CS Spirální hadice
 RO Furtun în spirală
 HU Spiráltömlő
 ES Manguera espiral

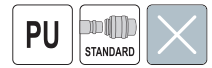

No.	Internal diameter / Średnica wewnętrzna [mm]	External diameter / Średnica zewnętrzna [mm]	L [m]	
81500	5	8	5	50
81501	5	8	10	25
81502	5	8	15	25

EN Armoured hose
 PL Wąż zbrojony
 DE Schlauch, verstärkt durch Bewehrung
 RU Шланг армированный для подачи воздуха
 CS Hadice vyztužená
 RO Furtun armat
 HU Fémbetétes tömlő
 ES Manguera armada

No.	Internal diameter / Średnica wewnętrzna [mm]	L [m]	Wall thickness / Grubość ścianki [mm]	ATM	
81519	6	50	2.5	10/40	1
81520	8	50	2.5	10/40	1
81521	10	50	2.5	10/40	1
81522	12	50	2.5	10/40	1
81523	14	50	3.0	10/40	1
81524	16	50	3.0	10/40	1
81525	19	50	3.5	10/40	1
81527	25	50	4.0	10/40	1



EN Quick coupler
 PL Szybkozłącze
 DE Schnellkupplung
 RU Быстроразъемное муфта с наружной резьбой
 CS Rychlospojka
 RO Mufa rapida pt. pistol pneumatic
 HU Gyorscsatlakozó
 ES Conexión de la entrada de aire

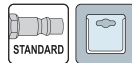

No.	Thread size / Rozmiar gwintu	
81370	G1/4	20/120
81371	G3/8	20/120
81372	G1/2	20/120

EN Quick coupler
 PL Szybkozłącze
 DE Schnellkupplung
 RU Быстроразъемное соединение с внутренней резьбой
 CS Rychlospojka
 RO Mufa rapida pt. pistol pneumatic
 HU Gyorscsatlakozó
 ES Conexión de la entrada de aire



No.	Thread size / Rozmiar gwintu	
81373	G1/4	20/120
81374	G3/8	20/120

EN Quick coupler
 PL Szybkozłącze
 DE Schnellkupplung
 RU Быстроразъемное соединение на шланг
 CS Rychlospojka
 RO Mufa rapida pt. pistol pneumatic
 HU Gyorscsatlakozó
 ES Conexión de la entrada de aire



No.	Connector diameter / Średnica krócca [mm]	
81378	6	20/120
81379	8	20/120
81380	10	20/120

EN Quick coupler
 PL Szybkozłącze
 DE Schnellkupplung
 RU Быстроразъемное соединение (штуцер), внутренняя резьба
 CS Rychlospojka
 RO Mufa rapida pt. pistol pneumatic
 HU Gyorscsatlakozó
 ES Conexión de la entrada de aire



No.	Thread size / Rozmiar gwintu	
81390	G1/4	50/250
81391	G3/8	50/250

- EN Quick coupler
- PL Szybkozłącze
- DE Schnellkupplung
- RU Быстрое соединение
- CS Rychlospojka
- RO Mufa rapida pt. pistol pneumatic
- HU Gyorscsatlakozó
- ES Conexión de la entrada de aire

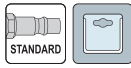

No.	Thread size / Rozmiar gwintu	
81387	G1/4	50/250

- EN Pneumatic riveting machine
- PL Nitownica pneumatyczna
- DE Druckluft Nietzange
- RU Пневматический заклепочник
- CS Pneumatická nýtovačka
- RO Presa pneumatica pt. nituit
- HU Pneumatikus popszegecsűző
- ES Máquina remachadora



$$L_{pA} = 76,1 \pm 3 \text{ dB}; L_{wA} = 87,1 \pm 3 \text{ dB}; a_h = 0,85 \pm 0,59 \text{ m/s}^2$$

No.	Ø [mm]	Max. piston stroke / Maks. skok tłoka silownika [mm]	F [kg]	F [N]	
70280	2,4, 3,2, 4, 4,8	14	720	7060	10

- EN Quick coupler
- PL Szybkozłącze
- DE Schnellkupplung
- RU Быстроразъёмное соединение (штуцер), „ёлочка” с обжимным кольцом
- CS Rychlospojka
- RO Mufa rapida pt. pistol pneumatic
- HU Gyorscsatlakozó
- ES Conexión de la entrada de aire

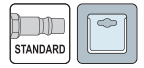

No.	Connector diameter / Średnica króćca [mm]	
81399	6	50/250
81400	8	50/250
81401	10	50/250



14 mm	85 l/min
0.63 MPa	720 kg / 7060 N
STANDARD	x4



Memo

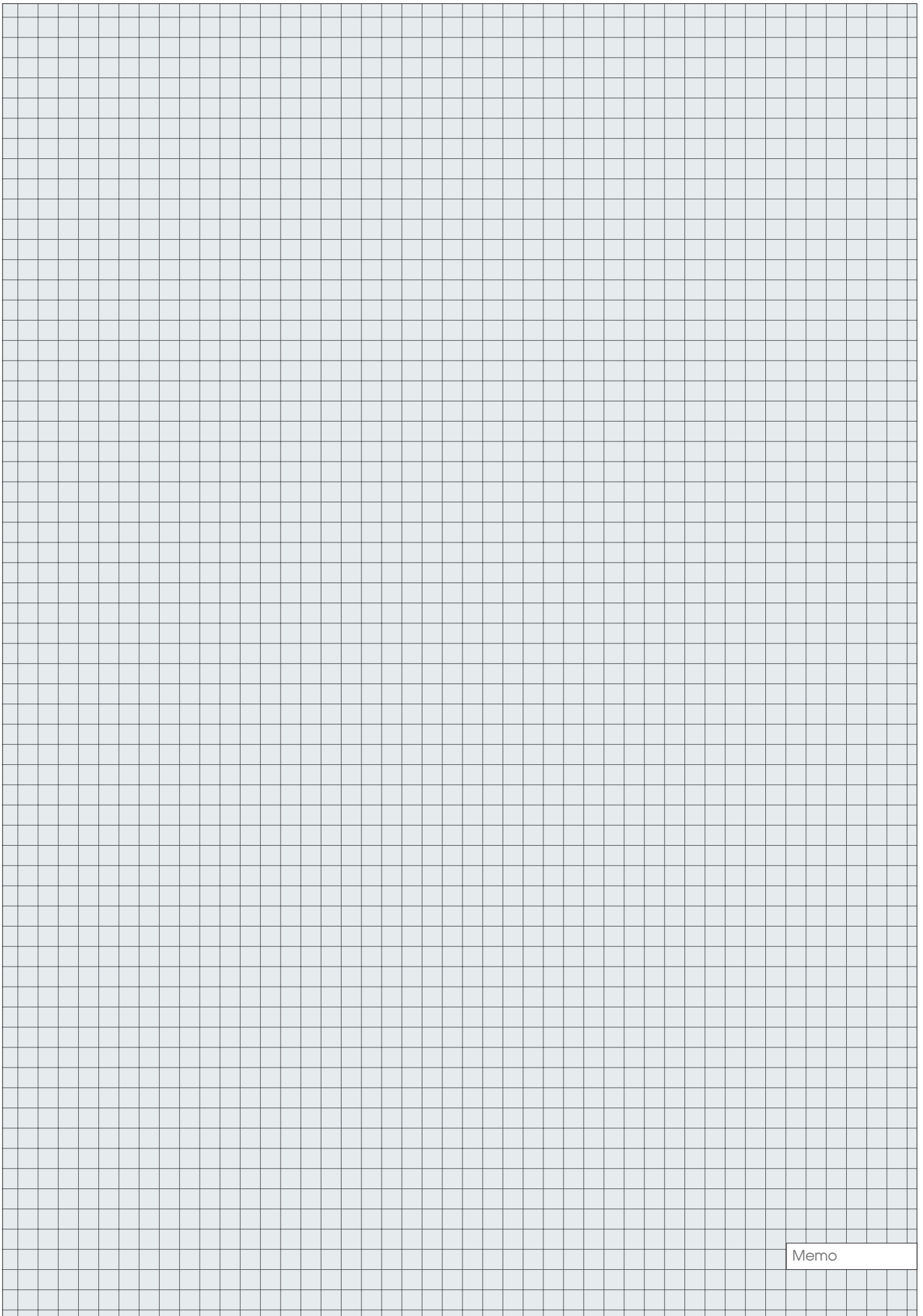

Memo

14

Special automotive tools & equipment Narzędzia i wyposażenie warsztatu samochodowego



Cabinets Szafki

220-226



Roller cabinets with tools insert Szafki serwisowe z narzędziami.....	220
Tool cabinets Szafki serwisowe.....	223
Workbenches & workshop desks Stoły i biurka warsztatowe.....	224
Trolley tool boxes Wózki narzędziowe.....	225

Lubrication tools Narzędzia do smarowania

226-231



Grease guns & oil transfer pumps Smarownice ręczne i pompy transferowe do oleju.....	226
Manual oil pumps Pompy ręczne do oleju.....	227
Oil cans Oliwiarki.....	229
Oil filter wrenches Klucze do filtra oleju.....	229

Pullers Ściągacze

231-232



Gear pullers Ściągacze do łożysk.....	231
Spring pullers Ściągacze do sprężyn.....	231
Ball joint removers Ściągacze do sworzni kulistych.....	232

Workshop tools Narzędzia warsztatowe

232-243



Wheel wrenches Klucze do kół.....	232
Piston ring compressors Zaciskacze do pierścieni.....	233
Spark plug sockets Klucze do świec.....	233
Vacuum pumps Pompy podciśnieniowe.....	234
Brake system tools Narzędzia do obsługi układu hamulcowego.....	234
Paint thickness & car voltage testers Tester grubości lakieru i samochodowe próbniki napięcia.....	234
Magnetic pick up tools Chwytaaki magnetyczne.....	235
Workshop seats Taborety warsztatowe.....	235
Impact wrenches Klucze udarowe.....	236
Workshop lamps Lampy warsztatowe.....	236

Bottle & floor jacks Dźwigniki słupkowe i podnośniki.....	239
Scissors jacks Podnośniki mechaniczne.....	240
Jack stands Podstawki pod samochód.....	240
Porta power kits Rozpieraki hydrauliczne.....	241
Pull-back rams Ściągacze blacharskie hydrauliczne.....	241
Battery chargers Prostowniki.....	241
Battery testers Testery akumulatorów.....	242
Tire pressure gauges Mierniki ciśnienia.....	242
Chain blocks Wciągarki łańcuchowe.....	243

Car accessories Akcesoria samochodowe

243-254



Pumps Pompy.....	243
Air compressors Kompresory.....	244
Air wedges Poduszki montażowe.....	244
Tow ropes Linki holownicze.....	244
Battery clamp cleaners Szczotki do czyszczenia klem.....	245
Battery hydrometers Próbniki akumulatorowe.....	246
Booster cables Wiązki przewodów awaryjnych.....	246
Scrapers & brushes Skrobaczki i szczotki.....	246
Flexible funnels Lejki.....	247
Car vacuum cleaners Odkurzacze samochodowe.....	248
Portable shower sets Pryszniczki turystyczne.....	249
First aid kits Apteczki.....	249
Safety triangles Trójkąty ostrzegawcze.....	249
Ratchet tie downs Taśmy do bagażu.....	249
Tarpaulins & accessories Plandeki i akcesoria.....	252

EN Service tool cabinet with tools
 PL Szafka serwisowa z narzędziami
 DE Serviceschrank mit Werkzeugen
 RU Сервисный шкаф с инструментами
 CS Servisní skříňka s nářadím
 RO Dulap echipat cu scule
 HU Szervizszekrény szerszámokkal
 ES Armario para herramientas de servicio



14

4 interchangeable trays with tools

4 wymienne moduły z narzędziami



No.	Drawer quantity / Liczba szuflad	
58570	6	1

Drawer 1 / Szuflada 1

- 1/4" (6.3 mm): 3.5, 4, 4.5, 5, 5.5, 6, 7, 8, 9, 10, 11, 12, 13, 14 mm; CrV;
- 1/4" (6.3 mm): E4, E5, E6, E7, E8; CrV;
- 1/4" (6.3 mm); CrV;
- 1/4" (6.3 mm) x2; CrV;
- 1/4" (6.3 mm); CrV;
- 1/4" (6.3 mm); CrV;
- 1/4" (6.3 mm); CrV;
- 1/4" (6.3 mm); 45T; CrV;
- 1/4" (6.3 mm) x 1/4" (6.3 mm); CrV 50BV30;
- 1/4" (6.3 mm): 3, 4, 5.5, 6.5, 7, 8, 9 mm;
- 1/4" (6.3 mm): PH0; PH1; PH2; PH3;
- 1/4" (6.3 mm): PZ0, PZ1, PZ2, PZ3;
- 1/4" (6.3 mm): T8, T9, T10, T15, T20, T25, T27, T30;
- 1/4" (6.3 mm): T8, T9, T10, T15, T20, T25, T27, T30;
- 1/4" (6.3 mm): 3, 4, 5, 6, 7, 8 mm;
- 1/4" (6.3 mm) S0, S1, S2;
- 1/4" (6.3 mm): 4, 5.5, 6.5 mm; CrV;
- 1/4" (6.3 mm): PH1, PH2, PH3; CrV;
- 1/4" (6.3 mm): PZ1, PZ2, PZ3; CrV;
- 1/4" (6.3 mm): T8, T10, T15, T20, T25, T27, T30; CrV;
- 1/4" (6.3 mm): 5, 6, 7, 8 mm; CrV;
- 1/2" (12.7 mm): 10, 11, 12, 13, 14, 15, 16, 17, 18, 19, 20, 21, 22, 23, 24, 27, 30, 32 mm; CrV;
- 1/2" (12.7 mm); 45T; CrV;
- 1/2" (12.7 mm); CrV;
- 1/2" (12.7 mm); CrV;
- 1/2" (12.7 mm): 16; 21 mm; CrV;

Drawer 2 / Szuflada 2

- 5/32" (4 mm); CrV 6150;
- 5/32" (4 mm): 1.0, 1.5, 2.0, 2.5, 3.0, 3.5 mm; CrV 6150;
- 5/32" (4 mm): PH000; PH00; PH0; PH1; CrV 6150;
- 5/32" (4 mm): PZ0, PZ1; CrV 6150;
- 5/32" (4 mm): T4, T5, T6, T7, T8, T9, T10, T15, T20; CrV 6150;
- 5/32" (4 mm): 0.7, 0.9, 1.3, 2.0, 2.5, 3.0, 4.0 mm; CrV 6150;
- 5/32" (4 mm): 2.5, 3.0, 3.5, 4.0, 4.5, 5.0, 5.5 mm;
- CrV;
- 2.0, 2.5, 3.0, 4.0, 5.0, 5.5, 6.0, 8.0, 10.0, 12 mm; CrV;
- T10, T15, T20, T25, T27, T30, T40, T45, T50; CrV;
- 3x75 mm, 5x100 mm, 6x100 mm, 8x150 mm; CrV;
- PH0x75 mm, PH1x100 mm, PH2x100 mm, PH3x150 mm; CrV

EN Service tool cabinet with tools
 PL Szafka serwisowa z narzędziami
 DE Serviceschrank mit Werkzeugen
 RU Сервисный шкаф с инструментами
 CS Servisní skříňka s náradím
 RO Dulap echipat cu scule
 HU Szerviszekrény szerszámmal
 ES Armario para herramientas de servicio

177 PCS	901x770 x458 mm	6x	DRAWERS LOCKING BLOKADA SZUFLAD	CENTRAL LOCK BLOKADA CENTRALNA	2x
∅125mm	2x	BALL BEARINGS ŁOŻYSKA KULKOWE	NON SLIP WORKTOP BLAT ANTY-POŚLIZGOWY	UNIVERSAL PERFORATION UNIWERSALNA PERFORACJA	

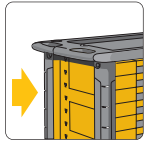

12 interchangeable trays with tools

12 wymiennych modułów z narzędziami



No.	Drawer quantity / Liczba szuflad	
58540	6	1

Drawer 1 / Szuflada 1

- 1/2" (12.7 mm): 10, 11, 12, 13, 14, 15, 16, 17, 18, 19, 20, 21, 22, 23, 24, 27, 30, 32 mm; CrV 50BV30;
- 1/2" (12.7 mm); (127 mm); CrV 50BV30;
- 1/2" (12.7 mm); CrV 50BV30;
- 1/2" (12.7 mm); (255 mm); 72T; CrV 6140;
- 1/2" (12.7 mm); (255 mm); CrV 50BV30;
- 1/2" (12.7 mm); 16; 21 mm; CrV 50BV30;
- 3/8" (9.5 mm): 6, 7, 8, 9, 10, 11, 12, 13, 14, 15, 16, 17, 18, 19, 20, 21, 22 mm; CrV 50BV30;
- 3/8" (9.5 mm); (76, 152.4 mm); CrV 50BV30;
- 3/8" (9.5 mm); CrV 50BV30;
- 3/8" (9.5 mm); (200 mm); 72T; CrV 6140;
- 3/8" (9.5 mm); (198 mm); CrV 50BV30;
- 1/4" (6.3 mm): 3.5, 4, 4.5, 5, 5.5, 6, 7, 8, 9, 10, 11, 12, 13, 14 mm; CrV 50BV30;
- 1/4" (6.3 mm); 8, 10, 11, 12, 13 mm; CrV 50BV30;
- 1/4" (6.3 mm); (50.8, 101.6 mm); CrV 6140;
- 1/4" (6.3 mm); CrV 50BV30;
- 1/4" (6.3 mm); (155 mm); 72T; CrV 6140;
- 1/4" (6.3 mm); (150 mm); CrV 50BV30;
- 1/4" (6.3 mm); (152.4 mm); CrV 50BV30;

Drawer 2 / Szuflada 2

- 3x75 mm, 5x100 mm, 5x150 mm, 6x38 mm, 6x100 mm, 6x150 mm, 8x150 mm; CrV;
- PH0x100 mm, PH1x75 mm, PH1x100 mm, PH2x38 mm, PH2x100 mm, PH2x150 mm, PH3x150 mm; CrV;
- 180 mm;
- 160 mm;
- 160 mm;
- 160 mm; bent / wygięte

Drawer 3 / Szuflada 3

- 6x7, 8x9, 10x11, 12x13, 14x15, 16x17, 18x19 mm;
- 22, 24, 27, 28, 30, 32 mm;
- 6, 7, 8, 9, 10, 11, 12, 13, 14, 15, 16, 17, 18, 19, 20, 21 mm

Drawer 4 / Szuflada 4

- 1/2" (12.7 mm): 8, 9, 10, 11, 12, 13, 14, 15, 16, 17, 18, 19, 20, 21 mm (L=76 mm); CrV 50BV30;
- 1/2" (12.7 mm), 3/8" (9.5 mm);
- 4, 5, 6, 7, 8, 10, 12 mm (L=30 mm); 4, 5, 6, 7, 8, 10, 12 mm (L=75 mm); CrV;
- M5, M6, M7, M10, M12 (L=30 mm); M5, M6, M7, M10, M12 (L=75 mm); CrV;
- T20, T25, T30, T40, T45, T50, T55 (L=30 mm); T20, T25, T30, T40, T45, T50, T55 (L=75 mm); CrV;
- 300 g (L=300 mm);
- 40 mm (L=300 mm);
- 10x8x142 mm, 12x10x152 mm, 16x13x170 mm

EN Service tool cabinet with tools
 PL Szafka serwisowa z narzędziami
 DE Serviceschrank mit Werkzeugen
 RU Сервисный шкаф с инструментами
 CS Servisní skříňka s nářadím
 RO Dulap echipat cu scule
 HU Szervizszekrény szerszámmal
 ES Armario para herramientas de servicio

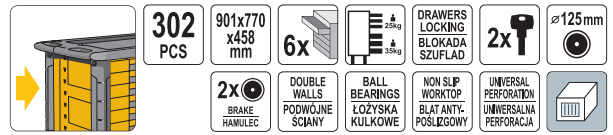

Drawer 1 / Szuflada 1

- 1/2" (12.7 mm): 10, 11, 12, 13, 14, 15, 16, 17, 18, 19, 20, 21, 22, 23, 24, 27, 30, 32 mm; CrV;
- 1/2" (12.7 mm): 45T; CrV;
- 1/2" (12.7 mm): CrV;
- 1/2" (12.7 mm): CrV;
- 1/2" (12.7 mm): 16; 21 mm; CrV;
- 3/8" (9.5 mm): 6, 7, 8, 9, 10, 11, 12, 13, 14, 15, 16, 17, 18, 19, 20, 21, 22 mm; CrV;
- 3/8" (9.5 mm) x2; CrV;
- 3/8" (9.5 mm); CrV;
- 3/8" (9.5 mm): 45T; CrV;
- 3/8" (9.5 mm); CrV;
- 1/4" (6.3 mm): 3.5, 4, 4.5, 5, 5.5, 6, 7, 8, 9, 10, 11, 12, 13, 14 mm; CrV;
- 1/4" (6.3 mm): E4, E5, E6, E7, E8; CrV;
- 1/4" (6.3 mm); CrV;
- 1/4" (6.3 mm) x2; CrV;
- 1/4" (6.3 mm); CrV;
- 1/4" (6.3 mm); CrV;
- 1/4" (6.3 mm); 45T; CrV;
- 1/4" (6.3 mm) x 1/4" (6.3 mm); CrV 50BV30;
- 1/4" (6.3 mm): 3, 4, 5.5, 6.5, 7, 8, 9 mm;
- 1/4" (6.3 mm): PH0; PH1; PH2; PH3;
- 1/4" (6.3 mm): PZ0, PZ1, PZ2, PZ3;
- 1/4" (6.3 mm): T8, T9, T10, T15, T20, T25, T27, T30;
- 1/4" (6.3 mm): T8, T9, T10, T15, T20, T25, T27, T30;
- 1/4" (6.3 mm): 3, 4, 5, 6, 7, 8 mm;
- 1/4" (6.3 mm) S0, S1, S2;
- 1/4" (6.3 mm): 4, 5.5, 6.5 mm; CrV;
- 1/4" (6.3 mm): PH1, PH2, PH3; CrV;
- 1/4" (6.3 mm): PZ1, PZ2, PZ3; CrV;
- 1/4" (6.3 mm): T8, T10, T15, T20, T25, T27, T30; CrV;
- 1/4" (6.3 mm): 5, 6, 7, 8 mm; CrV

Drawer 2 / Szuflada 2

- 3/8" (9.5 mm): 4, 5, 6, 7, 8, 10, 12 mm (L=30 mm); 4, 5, 6, 7, 8, 10, 12 mm (L=75 mm); AISI S2;
- 3/8" (9.5 mm): M5, M6, M8, M10, M12 (L=30 mm); M5, M6, M8, M10, M12 (L=75 mm); AISI S2;
- 3/8" (9.5 mm): T20, T25, T30, T40, T45, T50, T55 (L=30 mm); T20, T25, T30, T40, T45, T50, T55 (L=75 mm); AISI S2;
- 1/2" (12.7 mm) x 3/8" (9.5 mm), 3/8" (9.5 mm) x 3/8" (9.5 mm); CrV 6150;
- 1/2" (12.7 mm): 14, 15, 17; 19, 22 mm; CrV;
- 1/2" (12.7 mm): E18, E20, E24; CrV;
- 3/8" (9.5 mm): E10, E11, E12; E14, E16; CrV;
- 1/2" (12.7 mm); CrV;
- 1/2" (12.7 mm); CrV;
- 6, 7, 8, 9, 10, 11, 12, 13, 14, 15, 16, 17, 18, 19, 20, 21 mm

Drawer 3 / Szuflada 3

- 5/32" (4 mm); CrV 6150;
- 5/32" (4 mm): 1.0, 1.5, 2.0, 2.5, 3.0, 3.5 mm; CrV 6150;
- 5/32" (4 mm): PH000; PH00; PH0; PH1; CrV 6150;
- 5/32" (4 mm): PZ0, PZ1; CrV 6150;
- 5/32" (4 mm): T4, T5, T6, T7, T8, T9, T10, T15, T20; CrV 6150;
- 5/32" (4 mm): 0.7, 0.9, 1.3, 2.0, 2.5, 3.0, 4.0 mm; CrV 6150;
- 5/32" (4 mm): 2.5, 3.0, 3.5, 4.0, 4.5, 5.0, 5.5 mm;
- CrV;
- 2.0, 2.5, 3.0, 4.0, 5.0, 5.5, 6.0, 8.0, 10.0, 12 mm; CrV;
- T10, T15, T20, T25, T27, T30, T40, T45, T50; CrV;
- external straight / proste zewnętrzne;
- internal straight / proste wewnętrzne;
- external bent / wygięte zewnętrzne;
- internal bent / wygięte wewnętrzne;

Drawer 4 / Szuflada 4

- 300g;
- Ø 28 mm;
- 12x150 mm, 16x170 mm;
- 1.5x150 mm, 3x150 mm, 5x150 mm, 8x150 mm;
- 6x100 mm, 2x140 mm;
- 3x75 mm, 5x100 mm, 6x100 mm, 8x150 mm; CrV;
- PH0x75 mm, PH1x100 mm, PH2x100 mm, PH3x150 mm; CrV;
- 300 mm;
- 300 mm;
- 300 mm;
- 300 mm;
- 300 mm;

12 interchangeable trays with tools

12 wymiennych modułów z narzędziami



No.	Drawer quantity / Liczba szuflad	
58550	6	1

EN Roller cabinet
 PL Szafka serwisowa
 DE Werkstattrollwagen
 RU Инструментальный кабинет
 CS Dilenská skříňka
 RO Dulap de scule
 HU Szerviz - szekrény
 ES Armario en ruedas

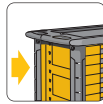
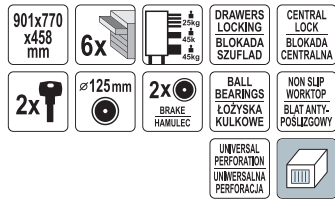

No.	Drawer quantity / Liczba szuflad	
58539	6	1

EN Shutter cabinet
 PL Szafka wisząca
 DE Hängeschrank
 RU Подвесной шкаф
 CS Závěsná skříňka
 RO Dulap cu 2 usi
 HU Függő szekrény
 ES Armario de pared

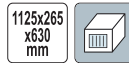

No.	Dimensions / Wymiary [mm]	
58440	1125x265x630	1

EN Roller cabinet
 PL Szafka serwisowa
 DE Werkstattrollwagen
 RU Инструментальный кабинет
 CS Dilenská skříňka
 RO Dulap de scule
 HU Szerviz - szekrény
 ES Armario en ruedas

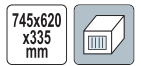

No.	Drawer quantity / Liczba szuflad	
81830	6	1

EN Shutter cabinet
 PL Szafka wisząca
 DE Hängeschrank
 RU Подвесной шкаф
 CS Závěsná skříňka
 RO Dulap cu 2 usi
 HU Függő szekrény
 ES Armario de pared

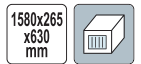

No.	Dimensions / Wymiary [mm]	
58441	1580x265x630	1

- EN Magnetic tool holder
- PL Zestaw listew magnetycznych
- DE Magnet Werkzeughalter
- RU Магнитная рейка
- CS Magnetický držák nářadí
- RO Suport magnetic
- HU Mágneses tartó
- ES Bandeja de accesorios magnética

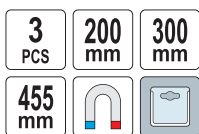

No.	pcs / szt.	
57830	3	6/12

- EN Service utility key
- PL Klucz do szafek serwisowych
- DE Schaltschrank-Schlüssel für Gängige Schränke
- RU Ключ для сервисных шкафов
- CS Klíč na rozvodné skříně
- RO Cheie universală pt. panoul de comandă
- HU Kapcsolószekrény kulcs
- ES Llaves para armarios de control



No.		
78477		12/72

- EN Workbench
- PL Stół warsztatowy
- DE Werkstatttisch
- RU Верстак
- CS Pracovní stůl
- RO Banc de lucru
- HU Munkaasztal
- ES Mesa de trabajo



No.	Drawer quantity / Liczba szuflad	Dimensions / Wymiary [mm]	
58455	5	1160x600x840	1

- EN Workshop desk
- PL Biurko warsztatowe
- DE Schreibtisch für Werkstatt
- RU Письменный стол для мастерской
- CS Pracovní stůl
- RO Masa de lucru
- HU Munkaasztal
- ES Escritorio de trabajo



No.	Dimensions / Wymiary [mm]	
58450	1160x600x830	1

- EN Workbench
- PL Stół warsztatowy
- DE Werkstatttisch
- RU Верстак
- CS Pracovní stůl
- RO Banc de lucru
- HU Munkaasztal
- ES Mesa de trabajo



No.	Drawer quantity / Liczba szuflad	Dimensions / Wymiary [mm]	
58456	6	1700x600x840	1

EN Work bench
 PL Stół monterski
 DE Montagetisch
 RU Монтажный столик
 CS Montérský stůlk
 RO Banc de lucru
 HU Szerelőasztal
 ES Mesa para bricolaje



No.
29420



EN Trolley toolbox, 2 segments
 PL Wózek narzędziowy z wyjmowanym organizerem
 DE Werkzeugtrolley mit abnehmbarem Organizaeraufsatz
 RU Мешок для инструментов с вынимаемым организером
 CS Vozík na nářadí s odnímatelným organizérem
 RO Troler pt. scule 2 segmente
 HU Kerekesszerszámoszláda kivehető szervezővel
 ES Carro de herramientas con organizador extraíble



No.
78734



EN Trolley toolbox, 2 segments
 PL Wózek narzędziowy 2-segmentowy
 DE Werkzeugtrolley 2-Teilig
 RU Мешок для инструментов 2 секции
 CS Vozík na nářadí 2 segmenty
 RO Troler pt. scule 2 segmente
 HU Kerekesszerszámoszláda 2 részes
 ES Carro de herramientas 2 compartimentos



No.
78731



EN Trolley toolbox, 3 segments
 PL Wózek narzędziowy 3-segmentowy
 DE Werkzeugtrolley 3-Teilig
 RU Мешок для инструментов 3 секции
 CS Vozík na nářadí 3 segmenty
 RO Troler pt. scule 3 segmente
 HU Kerekesszerszámoszláda 3 részes
 ES Carro de herramientas 3 compartimentos



No.
78736



- EN Trolley toolbox, 3 segments
- PL Wózek narzędziowy 3-segmentowy
- DE Werkzeugtrolley 3-Teilig
- RU Мешок для инструментов 3 секции
- CS Vozík na nářadí 3 segmenty
- RO Troler pt. scule 3 segmente
- HU Kerekcsészámolóda 3 részés
- ES Carro de herramientas 3 compartimentos

57x37
x84.5
cm

x3
SEGMENTS
SEGMENTY

54-98
mm

ABS

STEEL
STAL



No.	Tank capacity / Pojemność zbiornika [cm ³]	Box icon
78738	400	1

- EN Lever grease gun
- PL Smarownica
- DE Handhebel-Fettpresse
- RU Шприц для масляной смазки
- CS Páková maznice
- RO Masina de gresat cu furtun rigid
- HU Karos zsírzó
- ES Pistola de engrase

400
cm³

41-69
MPa

AI

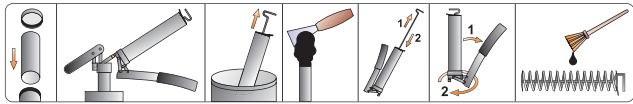

No.	Tank capacity / Pojemność zbiornika [cm ³]	Box icon
78041	400	5/10

- EN Lever grease gun
- PL Smarownica
- DE Handhebel-Fettpresse
- RU Шприц для масляной смазки
- CS Páková maznice
- RO Masina de gresat cu furtun rigid
- HU Karos zsírzó
- ES Pistola de engrase



No.	Tank capacity / Pojemność zbiornika [cm ³]	Box icon
78047	500	10

- EN Lever grease gun
- PL Smarownica
- DE Handhebel-Fettpresse
- RU Шприц для масляной смазки
- CS Páková maznice
- RO Masina de gresat cu furtun rigid
- HU Karos zsírzó
- ES Pistola de engrase

400
cm³



No.	Tank capacity / Pojemność zbiornika [cm ³]	Box icon
78040	400	10

- EN Lever grease gun
- PL Smarownica
- DE Handhebel-Fettpresse
- RU Шприц для масляной смазки
- CS Páková maznice
- RO Masina de gresat cu furtun rigid
- HU Karos zsírzó
- ES Pistola de engrase

400
cm³



No.	Tank capacity / Pojemność zbiornika [cm ³]	Box icon
78046	400	10

- EN Lever grease gun
- PL Smarownica
- DE Handhebel-Fettpresse
- RU Шприц для масляной смазки
- CS Páková maznice
- RO Masina de gresat cu furtun rigid
- HU Karos zsírzó
- ES Pistola de engrase

400
cm³

41-69
MPa

AI

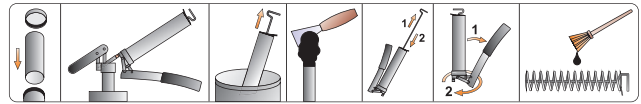

No.	Tank capacity / Pojemność zbiornika [cm ³]	Box icon
78042	400	5/10

500
cm³



EN Lever grease gun
 PL Smarownica
 DE Handhebel-Fettpresse
 RU Шприц для масляной смазки
 CS Páková maznice
 RO Masina de gresat cu furtun rigid
 HU Karos zsírító
 ES Pistola de engrase

600 cm³ 41-69 MPa AI

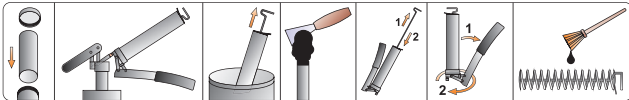

No.	Tank capacity / Pojemność zbiornika [cm ³]	
78043	600	6/12

EN Grease gun
 PL Smarownica ręczna
 DE Handhebel-Fettpresse
 RU Шприц для масляной смазки
 CS Páková maznice
 RO Masina de gresat cu furtun rigid
 HU Karos zsírító
 ES Pistola de engrase

120 g AI



No.	Tank capacity / Pojemność zbiornika [g]	
78039	120	30

EN Heavy duty jaw couplers
 PL Zestaw końcówek czteroczęściowych do smarownic
 DE Mundstücksatz für Handhebel-Fettpressen
 RU Соединительные патроны для масляного пистолета
 CS Sada koncovek k mazacímu lisu
 RO Doza de legatura
 HU Tömítő csatlakozó karos zsírítóhoz
 ES Juego de boquillas para engrasadores

4 PCS 15 mm 6-7 mm G 1/8-28



No.	Ø [mm]	pcs / szt.	
78061	15	4	20/80

EN Manual oil pump
 PL Pompa ręczna do oleju
 DE Öl-Umfüllpumpe
 RU Ручной насос для перекачки масел

CS Pumpa ruční na olej
 RO Pompa manuala apa ulei
 HU Kézi olajszivattyú
 ES Bomba manual para aceite

19 l/min FOR OIL DO OLEJU



No.	Max. capacity / Maks. wydajność [l/min]	
78000	19	5

EN Push type grease gun
 PL Smarownica wyciskowa
 DE Press-Fettspritze
 RU Шприц смазочный нажимной
 CS Vytlačovací maznice
 RO Gresor
 HU Kézi olajozó
 ES Engrasador

80 g



No.	Tank capacity / Pojemność zbiornika [g]	
78037	80	40

EN Flexible tube for grease gun
 PL Wążek do townitnicy
 DE Schlauch für Fettpresse
 RU Шприц для перекачки масел
 CS Hadička na maznice na šmir
 RO Furtun flexibil pt. pistol de gresat
 HU Tömítő a zsírítóhoz
 ES Manguera para engrasador

240 mm



No.	L [mm]	
78045	240	50/250

EN Flexible hose for grease gun
 PL Wążek giętki do smarownic
 DE Schlauch für Fettpresse
 RU Гибкий шланг для тоwnитницы
 CS Hadička na maznice na šmir
 RO Furtun flexibil pt. pistol de gresat
 HU Tömítő a zsírítóhoz
 ES Manguera para engrasador

6-7 mm G 1/8-28 31 MPa



No.	L [mm]	Max. pressure / Maks. ciśnienie [MPa]	
78067	300	31	50/250
78068	500	31	50/250

EN Manual oil pump
 PL Pompa ręczna do oleju
 DE Öl-Umfüllpumpe
 RU Ручной насос для перекачки масел
 CS Pumpa ruční na olej
 RO Pompa manuala apa ulei
 HU Kézi olajszivattyú
 ES Bomba manual para aceite

20
l/min

FOR OIL
DO
OLEJU



No.	Max. capacity / Maks. wydajność [l/min]	
78001	20	8

EN Manual oil pump
 PL Pompa ręczna do oleju
 DE Öl-Umfüllpumpe
 RU Ручной насос для перекачки масел
 CS Pumpa ruční na olej
 RO Pompa manuala apa ulei
 HU Kézi olajszivattyú
 ES Bomba manual para aceite

20
l/min

x3
PIPE
RURA

AI

FOR OIL
DO
OLEJU



No.	Max. capacity / Maks. wydajność [l/min]	
78002	20	10

EN Manual oil pump
 PL Mini pompa ręczna do oleju
 DE Öl-Umfüllpumpe
 RU Ручной насос для перекачки масел
 CS Pumpa ruční na olej
 RO Pompa manuala apa ulei
 HU Kézi olajszivattyú
 ES Bomba manual para aceite

15
l/min

AI

MINI

FOR OIL
DO
OLEJU

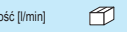

No.	Max. capacity / Maks. wydajność [l/min]	
78003	15	20

14

EN Self-priming fuel pump
 PL Samozasysający wąż do paliwa
 DE Selbstansaugender Kraftstoffschlauch
 RU Шланг с обратным клапаном для перекачки топлива
 CS Přetěpávací hadice se samonasávacím ventilem
 RO Furtun pt. transfer lichide
 HU Üzemanyag légtelenítő kézi pumpa
 ES Manguera aspiración manual

∅ **13**
mm

180
cm

SELF-
PRIMING
SAMO-
ZASYSAJĄCY

PVC





No.	
83009	6/24

EN Oil extractor
 PL Elektryczna pompa do oleju
 DE Ölabsaugpumpe
 RU Насос перекачки масла
 CS Čerpadlo na odsávání oleje
 RO Olajleszívó szivattyú
 HU Pompa electrica pt. extras ulei
 ES Bomba extractora de aceite eléctrica para coche

80
W

12
V

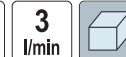
3
l/min

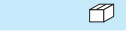

No.	Power / Moc [W]	
78007	80	10

EN Oil drainer
 PL Odsysarka ręczna do oleju
 DE Öl-Absaugpumpe
 RU Ручной шприц для откачки масла
 CS Ruční odsávačka oleje
 RO Pompa de ulei
 HU Kézi olajszivattyú
 ES Bomba manual de trasvase

200
cm³





No.	Tank capacity / Pojemność zbiornika [cm ³]	
78030	200	10

EN Oil drainer
 PL Odsysarka ręczna do oleju
 DE Öl-Absaugpumpe
 RU Ручной шприц для откачки масла
 CS Ruční odsávačka oleje
 RO Pompa de ulei
 HU Kézi olajszivattyú
 ES Bomba manual de trasvase

400
cm³

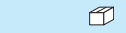

No.	Tank capacity / Pojemność zbiornika [cm ³]	
78031	400	10

EN Oil drainer
 PL Odsysarka ręczna do oleju
 DE Öl-Absaugpumpe
 RU Ручной шприц для откачки масла
 CS Ruční odsávačka oleje
 RO Pompa de ulei
 HU Kézi olajszivattyú
 ES Bomba manual de trasvase



No.	Tank capacity / Pojemność zbiornika [cm³]	Box
78044	500	10/20

EN Manual car oil pump
 PL Odsysarka ręczna do oleju
 DE Manuelle Öl-Absaugpumpe
 RU Ручной насос для откачки масла
 CS Ruční vakuová odsávačka oleje a kapalin
 RO Pompă de aspiratje pt. aspirația uleiului
 HU Kézi pumpás olajleszívó
 ES Bomba de vacío para aspiración de aceite



No.	Tank capacity / Pojemność zbiornika [l]	Box
78032	6	4

EN Oil can with flexible hose
 PL Oliwiarka z wężykiem
 DE Ölkanne mit flexiblem Aufsatz
 RU Масленка с гибким шлангом
 CS Olejová mазnice
 RO Cana ulei cu furtun flexibil
 HU Olajozó kanna, hajlékony tömlővel
 ES Aceitera



No.	Capacity / Pojemność [ml]	Box
78306	200	10/60

EN Oil can with rigid spout
 PL Oliwiarka z końcówką sztywną
 DE Ölkanne mit starrem Aufsatz
 RU Масленка с твердым наконечником
 CS Olejová mазnice
 RO Cana ulei cu furtun rigid
 HU Olajozó kanna, merev szárral
 ES Aceitera



No.	Capacity / Pojemność [ml]	Box
78303	300	10/60

EN Manual oil pump
 PL Pompa ręczna do oleju
 DE Öl-Umfüllpumpe
 RU Ручной насос для перекачки масел

CS Pumpa ruční na olej
 RO Pompa manuala apa ulei
 HU Kézi olajszivattyú
 ES Bomba manual para aceite



No.	Tank capacity / Pojemność zbiornika [cm³]	Box
78035	500	10

EN Oil can
 PL Oliwiarka
 DE Ölkanne
 RU Масленка
 CS Mазnička
 RO Pompiță de ulei
 HU Olajozó
 ES Aceitera



No.	Capacity / Pojemność [ml]	Box
78300	300	15/60

EN Oiler
 PL Oliwiarka
 DE Ölkanne
 RU Масленка
 CS Olejníčka
 RO Gresor
 HU Olajozó
 ES Aceitera



No.	Capacity / Pojemność [ml]	Box
78301	250	6/72

EN Oil filter wrench
 PL Klucz do filtra oleju
 DE Ölfilterschlüssel
 RU Ключ к масляному фильтру
 CS Klíč na olejový filtr
 RO Cheie pt. filtru de ulei
 HU Olajszűrő leszedő
 ES Llave para el filtro de aceite



No.	Ø	Ø [mm]	Box
57600	1/2" (12.7 mm)	65-110	6/36

EN Oil filter wrench
 PL Klucz do filtra oleju zaciskowy
 DE Ölfilterschlüssel
 RU Съёмник масляных фильтров зажимной

CS Klíč na filtr oleju svěrácí
 RO Cheie cu strângere pt. filtru de ulei
 HU Olajszűrő kulcs, pattintos
 ES Llave de filtro de apriete

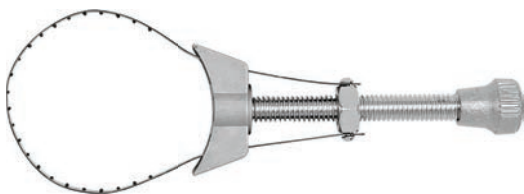

No.	Ø [mm]	
57610	55-110	10/50

EN Oil filter wrench
 PL Klucz do filtra oleju
 DE Ölfilterschlüssel
 RU Ключ к масляному фильтру

CS Klíč na olejový filtr
 RO Cheie pt. filtru de ulei
 HU Olajszűrő leszedő
 ES Llave para el filtro de aceite



No.		
57630		10/40

EN Oil filter wrench
 PL Klucz do filtra oleju
 DE Ölfilterschlüssel
 RU Ключ к масляному фильтру
 CS Klíč na olejový filtr
 RO Cheie pt. filtru de ulei
 HU Olajszűrő leszedő
 ES Llave para el filtro de aceite

3/8" 64-80 mm
 9.5 mm



No.	Ø	Ø [mm]	
57660	3/8" (9.5 mm)	64-80	6/36

EN Oil filter wrench
 PL Klucz do filtra oleju
 DE Ölfilterschlüssel
 RU Ключ к масляному фильтру

CS Klíč na filtr oleju
 RO Cheie pt. filtru de ulei
 HU Olajszűrő kulcs
 ES Llave para el filtro de aceite



No.	Ø [mm]	
57612	73-85	12/48
57613	83-95	12/48
57614	93-111	12/48

EN Oil filter wrench
 PL Klucz do filtra oleju
 DE Ölfilterschlüssel
 RU Ключ к масляному фильтру
 CS Klíč na olejový filtr
 RO Cheie pt. filtru de ulei
 HU Olajszűrő leszedő
 ES Llave para el filtro de aceite



No.		
57620		10/100

EN Oil filter wrench
 PL Klucz do filtra oleju
 DE Ölfilterschlüssel
 RU Ключ к масляному фильтру

CS Klíč na olejový filtr
 RO Cheie pt. filtru de ulei
 HU Olajszűrő leszedő
 ES Llave para el filtro de aceite



No.		
57640		25/100

EN Oil filter wrench
 PL Klucz do filtra oleju
 DE Ölfilterschlüssel
 RU Ключ к масляному фильтру

CS Klíč na filtr oleju
 RO Cheie pt. filtru de ulei
 HU Olajszűrő kulcs
 ES Llave para el filtro de aceite



No.	Ø [mm]	
57650	75-95	10/50

EN Oil filter wrench
 PL Klucz do filtra oleju
 DE Ölfilterschlüssel
 RU Ключ к масляному фильтру

CS Klíč na filtr oleju
 RO Cheie pt. filtru de ulei
 HU Olajszűrő kulcs
 ES Llave para el filtro de aceite



- EN Strap wrench set
 PL Zestaw kluczy taśmowych do filtrów oleju
 DE Ölfilter-Bandschlüssel-Set
 RU Набор ленточных ключей для масляных фильтров
 CS Sada řemenových klíčů na olejové filtry
 RO Set chei cu banda
 HU Olajszűrő leszedő készlet
 ES Juego de llaves de correa para filtros de aceite

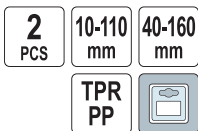

No.	Ø [mm]	pcs / szt.	
57616	10-110, 40-160	2	6/24

- EN Gear puller
 PL Ściągacz do łożysk
 DE Dreiarmliger Abzieher
 RU Съёмник подшипников 3-х лапчатый
 CS Stahovák na ložiska
 RO Clește cu 3 brațe pt. extras rulmenți
 HU Hidraulikus csapágyelhúzó
 ES Extractor de cojinetes



No.	Size / Rozmiar	Jaws range / Rozstaw szczęk [mm]	Wrench size / Rozmiar klucza [mm]	Arm quantity / Liczba ramion	
80470	3"	75	14	2	30
80471	4"	100	17	2	24
80472	5"	130	17	2	20
80473	6"	150	19	2	12
80474	8"	200	22	2	6

- EN Coil spring clamp
 PL Ściągacz do sprężyn
 DE Federspanner
 RU Съёмник пружин
 CS Stahovák pružin tlumičů automobilů
 RO Presa pt. arcuți
 HU Rugóösszehúzó
 ES Extractor de muelles



No.	pcs / szt.	
80600	2	6/12

- EN Gear puller
 PL Ściągacz do łożysk
 DE Dreiarmliger Abzieher
 RU Съёмник подшипников 3-х лапчатый
 CS Stahovák na ložiska
 RO Clește cu 3 brațe pt. extras rulmenți
 HU Hidraulikus csapágyelhúzó
 ES Extractor de cojinetes



No.	Size / Rozmiar	Jaws range / Rozstaw szczęk [mm]	Arm quantity / Liczba ramion	
80500	3"	75	3	4/40
80510	4"	100	3	5/30
80520	6"	150	3	2/20
80530	8"	200	3	2/12

- EN Seal puller
 PL Ściągacz do uszczelek
 DE Dichtungs- Abziehwerkzeug
 RU Съёмник прокладок
 CS Škrabka na těsnění
 RO Ancoră pt. garnitură
 HU Tömítéselhúzó
 ES Tensor para juntas



14

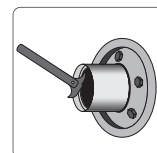

No.	L [mm]	
80701	325	6/36

- EN Coil spring clamp
 PL Ściągacz do sprężyn
 DE Federspanner
 RU Съёмник пружин
 CS Stahovák pružin tlumičů automobilů
 RO Presa pt. arcuți
 HU Rugóösszehúzó
 ES Extractor de muelles

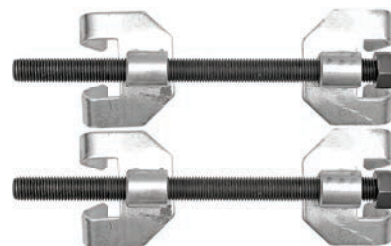

No.	pcs / szt.	
80601	2	10

EN Coil spring clamp
 PL Ściągacz do sprężyn
 DE Federspanner
 RU Съёмник пружин
 CS Stahovák pružin tlumičů automobilů
 RO Presa pt. arcuiri
 HU Rugóösszehúzó
 ES Extractor de muelles

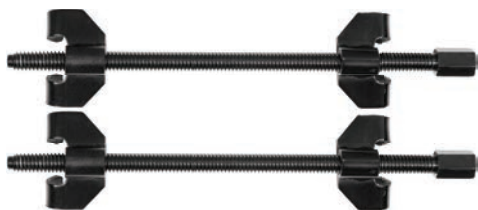
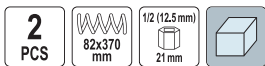

No.	Ø [mm]	L [mm]	pcs / szt.	
80602	82	370	2	12

EN Removal tool set
 PL Zestaw łomów
 DE Brechstangensatz
 RU Набор ломов
 CS Sada páčidel
 RO Set leviere
 HU Feszítővas készlet
 ES Juego de palancas



No.	Size / Rozmiar [mm]	pcs / szt.	
34182	16x305, 21x450	2	6/24

EN Tie rod end lifter
 PL Ściągacz do sworzni kulistych
 DE Universal-Kugelgelenk-Abzieher
 RU Съёмник шаровых опор
 CS Stahovák kulových čepů řízení
 RO Extractor pt. articulatii sferice
 HU Gömbfej kinyomó
 ES Extractor de pernos esféricos



No.	
80620	25/50

EN Tire lever set
 PL Zestaw łyżek do opon
 DE Reifenlöffel-Satz
 RU Набор шинных ложек
 CS Sada lžic na pneumatiky
 RO Set leviere
 HU Abroncs leszedő szerszámkészlet
 ES Juego de palancas para neumáticos

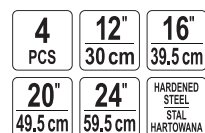
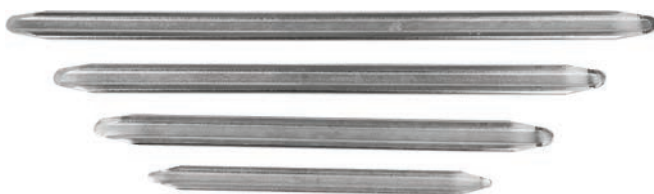

No.	pcs / szt.	
56980	4	10

EN Precision screwdriver and hook set
 PL Zestaw precyzyjnych wkrętek i haczyków
 DE Präzisions-Schraubendreher- und Haken-Satz
 RU Набор точных отверток и крючков
 CS Sada přesných šroubováků a háčků
 RO Set surubelnite de precizie
 HU Precíziós csavarhúzó és kampó készlet
 ES Set de destornilladores precisos y ganchos



No.	pcs / szt.	
64555	12	10/40

EN Removal tool set
 PL Zestaw łomów
 DE Brechstangensatz
 RU Набор ломов
 CS Sada páčidel
 RO Set leviere
 HU Feszítővas készlet
 ES Juego de palancas



No.	Size / Rozmiar [mm]	pcs / szt.	
34184	11x195, 16x305, 21x445, 21x600	4	2/12

EN Tie rod end lifter
 PL Ściągacz do sworzni kulistych
 DE Universal-Kugelgelenk-Abzieher
 RU Съёмник шаровых опор
 CS Stahovák kulových čepů řízení
 RO Extractor pt. articulatii sferice
 HU Gömbfej kinyomó
 ES Extractor de pernos esféricos

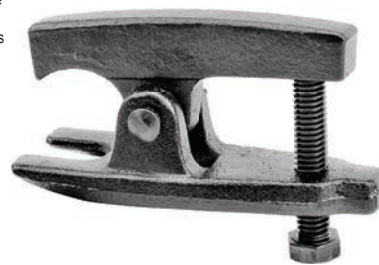

No.	
80640	25

EN Cross rim wrench
 PL Krzyżakowy klucz do kół
 DE Kreuzschlüssel
 RU Ключ-крест балонный
 CS Klíč na kola křížový
 RO Cheie în cruce pt. roți
 HU Kereszt kerékkulcs
 ES Llave cruz para ruedas



No.	Size / Rozmiar	
57000	17x19x22x13/16" (20.6 mm)	20

EN Cross rim wrench
 PL Krzyżakowy klucz do kół
 DE Kreuzschlüssel
 RU Ключ-крест балонный
 CS Klíč na kola křížový
 RO Cheie în cruce pt. roți
 HU Kereszt kerékkulcs
 ES Llave cruz para ruedas



No.	Size / Rozmiar [mm]	
57010	17x19x21x23	20

EN Cross rim wrench
 PL Krzyżakowy klucz do kół
 DE Kreuzschlüssel
 RU Ключ-крест балонный
 CS Klíč na kola křížový
 RO Cheie în cruce pt. roți
 HU Kereszt kerékkulcs
 ES Llave cruz para ruedas



No.	Size / Rozmiar	
57020	17x19x21x1/2" (12.7 mm)	10

EN Cross rim wrench
 PL Krzyżakowy klucz do kół
 DE Kreuzschlüssel
 RU Ключ-крест балонный
 CS Klíč na kola křížový
 RO Cheie în cruce pt. roți
 HU Kereszt kerékkulcs
 ES Llave cruz para ruedas



No.	Size / Rozmiar [mm]	
57030	17x19x22x23	20

EN Cross rim wrench
 PL Krzyżakowy klucz do kół
 DE Kreuzschlüssel
 RU Ключ-крест балонный
 CS Klíč na kola křížový
 RO Cheie în cruce pt. roți
 HU Kereszt kerékkulcs
 ES Llave cruz para ruedas



No.	Size / Rozmiar	
57050	24x27x32x3/4" (19.0 mm)	5

EN L-type wheel wrench
 PL Klucz do kół rozsuwany
 DE Radschlüssel
 RU Ключ балонный телескопический L-типа
 CS Klíč na kola rozvířný
 RO Cheie pt. roți extensibilă
 HU Kerékkulcs, kihúzható
 ES Llave para ruedas extensible

360-510 mm 17 mm 19 mm 1/2" 12.7 mm



No.	Size / Rozmiar [mm]	L [mm]	Ø	
57100	17x19	360-510	1/2" (12.7 mm)	10/20

EN Piston ring compressor
 PL Zaciskacz do pierścieni
 DE Kolbenring-Spannband
 RU Зажим колец
 CS Svěrka na kroužky
 RO Clește pt. strâns inele
 HU Gyűrűbepattintó
 ES Pinza para anillos



AISI 304

65Mn



No.	Ø [mm]	H [mm]	
80660	50-125	75	36
80661	75-175	100	36

EN Spark plug wrench
 PL Klucz do świec
 DE Zündkerzenschlüssel
 RU Ключ свечной
 CS Svíčkový klíč
 RO Cheie pt. bujii
 HU Gyertyakulcs
 ES Llave para bujias



No.	Size / Rozmiar [mm]	Length / Długość [mm]	
57160	16	150	25/50
57210	21	150	25/50

- EN Spark plug wrench
- PL Klucz do świec
- DE Zündkerzenschlüssel
- RU Ключ свечной
- CS Svičkový klíč
- RO Cheie pt. bujii
- HU Gyertyakulcs
- ES Llave para bujias



No.	Size / Rozmiar [mm]	L [mm]	
57260	16/21	150	25/50

- EN Hand-held vacuum pump
- PL Pompka podciśnieniowa z akcesoriami
- DE Unterdruckpumpe mit Zubehör
- RU Насос вакуумметрического давления с принадлежностями
- CS Podtlaková pumpa s příslušenstvím
- RO Pompa de vidare cu accesorii
- HU Vákuum- és ac-pumpa mérő, tartozékokkal
- ES Bomba de subpresión con accesorios

16 PCS **-0.1** MPa



No.	
81690	10

- EN Brake piston wind back
- PL Separator do zacisków hamulcowych
- DE Separator für Bremssättel
- RU Сепаратор для тормозных суппортов
- CS Oddělovač brzdových třmenů
- RO Extractor disc de frana
- HU Féknyereg dugattyú
- ES Separador para pinzas de freno

5 PCS

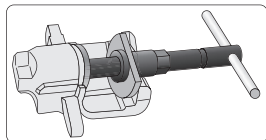

Audi, VW, Ford, Honda, Jaguar, Mazda, Mitsubishi, Nissan, Rover, Saab, Subaru, Skoda, Toyota, Volvo



No.	
57730	10/20

- EN Car voltage tester
- PL Samochodowy próbnik napięcia
- DE Autospannungstester
- RU Пробник автомобильный
- CS Automobilový zkoušeč napětí
- RO Creion de tensiune pt. automobile
- HU Autós fáziskereső
- ES Comprobador de corriente de coche

No.	Measuring range / Zakres pomiaru [V d.c.]	
65260	6-24	20/200

- EN Spark plug wrench
- PL Klucz do świec
- DE Zündkerzenschlüssel
- RU Ключ свечной
- CS Svičkový klíč
- RO Cheie pt. bujii
- HU Gyertyakulcs
- ES Llave para bujias



No.	Size / Rozmiar [mm]	L [mm]	
57220	16	260	20/40
57221	21	260	20/40

- EN Flare nut wrenches
- PL Klucze do przewodów hamulcowych
- DE Bremsleitungschlüsselsatz
- RU Набор ключей разрезных
- CS Klíče na vedení brzd
- RO Cheie pt. conducte de frână
- HU Féksőkulcs
- ES Llaves para tubería de frenado

3 PCS

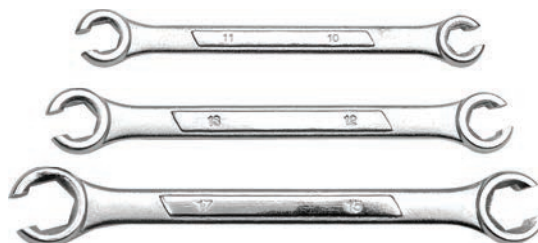

No.	pcs / szt.	
57700	3	12/60

- EN Paint thickness tester
- PL Tester grubości lakieru
- DE Lackdickmessgerät
- RU Тонциномер лакокрасочного покрытия
- CS Tester tloušťky laku
- RO Tester de buzunar grosime vopsea
- HU Rétegvastagság mérő
- ES Medidor de espesor de recubrimiento

0-2.0 mm **±2%**



No.	
81731	40/60



EN Car voltage tester
 PL Samochodowy próbnik napięcia
 DE Autospannungstester
 RU Пробник автомобильный

CS Automobilový zkoušeč napětí
 RO Creion de tensiune pt. automobile
 HU Autós fáziskereső
 ES Comprobador de corriente de coche



No.	Measuring range / Zakres pomiaru [V d.c.]	Icon
65270	6-24	20/200

EN Telescopic pick up and mirror set
 PL Zestaw inspekcyjny: lusterko + chwytak
 DE Inspektionssatz: Spiegel + Greifer
 RU Проверочный набор - держатель и зеркальце
 CS Inspekční souprava: zrcadlo + držák
 RO Garnitură de control: oglindă + benă
 HU Teleszkópos ellenőrző készlet: tükör + felvevő
 ES Juego de inspección: espejo + cuchara de mordazas

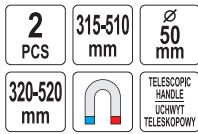

No.	pcs / szt.	Icon
78410	2	25/100

EN Magnetic wristband
 PL Opaska magnetyczna
 DE Haftmagnet
 RU Браслет магнитный
 CS Magnetický pás
 RO Bratară magnetică
 HU Mágneses szalag
 ES Banda magnética



No.	L [mm]	Icon
78756	320	12/96

EN Workshop seat with drawer
 PL Taboret warsztatowy z szufladą
 DE Werkstattthocker mit Schublade
 RU Табурет рабочий с ящиком
 CS Dílenský taburet se zásuvkou
 RO Taburet atelier cu sertar
 HU Műhelyi zsámoly fiókkal
 ES Taburete de taller con cajón



No.	Max. load capacity / Maks. obciążenie [kg]	Icon
81824	90	4

EN Pick-up tool
 PL Łapka do podnoszenia
 DE Starker Greifer
 RU Гибкий захват „Pick-up”
 CS Patka pro zdvihání
 RO Surubelnita flexibilă
 HU Emelőlapka
 ES Grifo para recoger pick up



No.	L [mm]	Icon
78400	600	50/150

EN Flexible pick-up handle, magnetic
 PL Łapka magnetyczna, gietka
 DE Magnetisch flexibler Greifer
 RU Гибкий магнитный захват
 CS Vytahovák magnetický ohebný
 RO Surubelnita flexibilă magnetică
 HU Mágneses felszedő eszköz, hajlékony nyél
 ES Grifo magnético flexible



No.	L [mm]	Icon
78401	600	50/100

EN LED magnetic pick up tool
 PL Chwyłak teleskopowy LED
 DE LED Magnet Heber
 RU Захват магнитный телескопический с подсветкой
 CS Patka magnetická teleskopická LED
 RO Telescop magnetic cu LED
 HU LED felszedő mágnes teleszkópos nyéllel
 ES Herramienta para levantar, telescópica, con LED

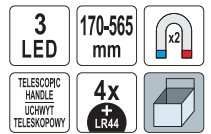

No.	Light source / Źródło światła [LED]	Battery type / Rodzaj baterii	Icon
78405	3	4x; LR44	12/48



- EN Pneumatic car seat
- PL Taboret warsztatowy teleskopowy
- DE Werkstattthocker, teleskopisch
- RU Табурет рабочий подъемный
- CS Dílenský taburet teleskopický
- RO Taburet atelier telescopic
- HU Teleszkópos műhely zsámoly
- ES Taburete de taller telescópico



No.	Max. load capacity / Maks. obciążenie [kg]	
81825	135	4

- EN Electric impact wrench
- PL Elektryczny klucz udarowy
- DE Elektro-Schlagschrauber
- RU Электрический гайковерт
- CS Elektrický rázový uťahovák
- RO Pistol de impact electric
- HU Elektromos ütvecsavarozó
- ES llave de impacto eléctrica



$L_{pA} = 89,0 \pm 3,0$ dB; $L_{wA} = 100,0 \pm 3,0$ dB; $a_n = 10,04 \pm 1,5$ m/s²

No.	Power / Moc [W]	Ω [min ⁻¹]	
57092	1100	2200	2

- EN Rechargeable work lamp
- PL Diodowa lampa bezprzewodowa
- DE Led Werkstattlampe
- RU Светодиодная беспроводная лампа
- CS Montážní lampa diodová bezpřívodová
- RO Lampa cu led fara cablu
- HU Ledlámpa
- ES Lámpara inalámbrica de diodos

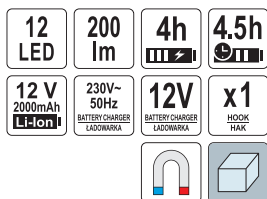

No.	Light source / Źródło światła [LED]	Battery capacity / Pojemność akumulatora [mAh]	
82728	12	2000	20

- EN Electric impact wrench
- PL Elektryczny klucz udarowy
- DE Elektro-Schlagschrauber
- RU Электрический гайковерт
- CS Elektrický rázový uťahovák
- RO Pistol de impact electric
- HU Elektromos ütvecsavarozó
- ES llave de impacto eléctrica



$L_{pA} = 87,5 \pm 3,0$ dB; $L_{wA} = 98,5 \pm 3,0$ dB; $a_n = 9,93 \pm 1,5$ m/s²



No.	Power / Moc [W]	Ω [min ⁻¹]	
57091	800	2200	5

- EN Electric impact wrench
- PL Elektryczny klucz udarowy
- DE Elektro-Schlagschrauber
- RU Электрический гайковерт
- CS Elektrický rázový uťahovák
- RO Pistol de impact electric
- HU Elektromos ütvecsavarozó
- ES llave de impacto eléctrica



$L_{pA} = 89,0 \pm 3,0$ dB; $L_{wA} = 100,0 \pm 3,0$ dB; $a_n = 10,04 \pm 1,5$ m/s²

No.	Power / Moc [W]	Ω [min ⁻¹]	
57097	1100	2200	2

- EN Rechargeable work lamp
- PL Diodowa lampa bezprzewodowa
- DE Led Werkstattlampe
- RU Светодиодная беспроводная лампа
- CS Montážní lampa diodová bezpřívodová
- RO Lampa cu led fara cablu
- HU Ledlámpa
- ES Lámpara inalámbrica de diodos

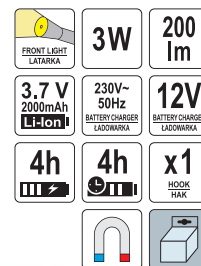

No.	Light source / Źródło światła [LED]	Battery capacity / Pojemność akumulatora [mAh]	
82719	1+3	2000	20

EN LED work light
 PL Lampa robocza LED
 DE LED Handleuchte
 RU Светодиодный светильник для мастерской
 CS Ruční svítidla LED
 RO Lampa portabila cu LED
 HU LED lámpa
 ES Lámpara de taller LED

3W 100 lm 2 LIGHTING MODES TRYBY SWIĘCZENIA 4h 3.7V 800mAh LEDon!

Micro USB x1 HOOK HAK



COB LED



No.	Power / Moc [W]	Battery capacity / Pojemność akumulatora [mAh]	Box
82723	3	800	12/48

EN LED work light
 PL Lampa robocza LED
 DE LED Handleuchte
 RU Светодиодный светильник для мастерской
 CS Ruční svítidla LED
 RO Lampa portabila cu LED
 HU LED lámpa
 ES Lámpara de taller LED

230V~50Hz 4.5 W 400 lm 24 LED

x1 HOOK HAK 5 m



SMD LED



No.	Power / Moc [W]	Light source / Źródło światła [LED]	Box
82706	4.5	24	10/20

EN Work light
 PL Lampa warsztatowa
 DE Werkstattlampe
 RU Лампа-переноска
 CS Pracovní lampa
 RO Lampă pt. atelier
 HU Szerelőlámpa
 ES Lámpara de taller

230V~50Hz 60 W E27 5 m



No.	Max. power of light source / Maks. moc źródła światła [W]	Series / Seria	Box
82715	60	PLASTIC	10

EN LED work light
 PL Lampa robocza LED
 DE LED Handleuchte
 RU Светодиодный светильник для мастерской
 CS Ruční svítidla LED
 RO Lampa portabila cu LED
 HU LED lámpa
 ES Lámpara de taller LED

230V~50Hz 3.2 W 280 lm 16 LED

x1 HOOK HAK 5 m

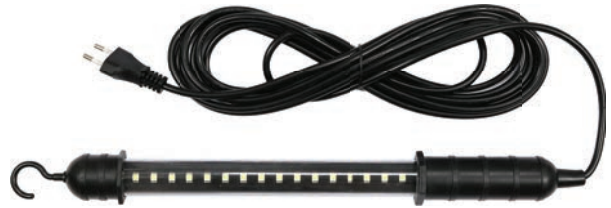

SMD LED



No.	Power / Moc [W]	Light source / Źródło światła [LED]	Box
82699	3.2	16	10/20

EN Work light
 PL Lampa warsztatowa
 DE Werkstattlampe
 RU Лампа-переноска
 CS Pracovní lampa
 RO Lampă pt. atelier
 HU Szerelőlámpa
 ES Lámpara de taller

230V~50Hz 100 W E27 5 m



No.	Max. power of light source / Maks. moc źródła światła [W]	Series / Seria	Box
82713	100	PRACTIC	10

EN Work light
 PL Lampa warsztatowa
 DE Werkstattlampe
 RU Лампа-переноска
 CS Pracovní lampa
 RO Lampă pt. atelier
 HU Szerelőlámpa
 ES Lámpara de taller

230V~50Hz 60 W E27 5 m



No.	Max. power of light source / Maks. moc źródła światła [W]	Series / Seria	Box
82714	60	CLASSIC	10

EN Work light
 PL Lampa warsztatowa
 DE Werkstattlampe
 RU Лампа-переноска
 CS Pracovní lampa
 RO Lampă pt. atelier
 HU Szerelőlámpa
 ES Lámpara de taller



No.	Max. power of light source / Maks. moc źródła światła [W]	Series / Seria	
82716	60	GUMMI	10
82717	100	GUMMI	10

EN LED work light
 PL Lampa robocza LED
 DE LED Handleuchte
 RU Светодиодный светильник для мастерской
 CS Ruční svítidla LED
 RO Lampă portabilă cu LED
 HU LED lámpa
 ES Lámpara de taller LED

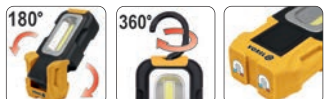

No.	Battery type / Rodzaj baterii	
82724	3x1.5V; AAA	12/48

EN LED work light
 PL Lampa robocza LED
 DE LED Handleuchte
 RU Светодиодный светильник для мастерской
 CS Ruční svítidla LED
 RO Lampă portabilă cu LED
 HU LED lámpa
 ES Lámpara de taller LED

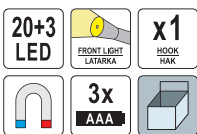

No.	Light source / Źródło światła [LED]	Battery type / Rodzaj baterii	
82730	20+3	3x1.5V; AAA	12/48

EN Rechargeable LED work light
 PL Lampa robocza akumulatorowa LED
 DE LED Akku-Handleuchte
 RU Аккумуляторный светодиодный светильник для мастерской
 CS Ruční svítidla LED
 RO Lampă portabilă cu acumulator leduri
 HU Ledes szerelőlámpa címkéjű cikke
 ES Linterna LED recargable

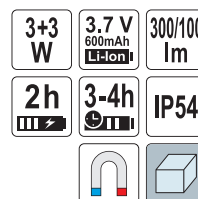

No.	Power / Moc [W]	Battery capacity / Pojemność akumulatora [mAh]	
82734	3+3	600	120

EN LED work light
 PL Lampa robocza LED
 DE LED Handleuchte
 RU Светодиодный светильник для мастерской
 CS Ruční svítidla LED
 RO Lampă portabilă cu LED
 HU LED lámpa
 ES Lámpara de taller LED



No.	Battery type / Rodzaj baterii	
82733	3x1.5V; AAA	24/48

EN LED work light
 PL Lampa robocza LED
 DE LED Handleuchte
 RU Светодиодный светильник для мастерской
 CS Ruční svítidla LED
 RO Lampă portabilă cu LED
 HU LED lámpa
 ES Lámpara de taller LED

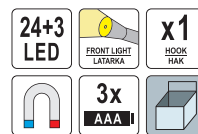

No.	Light source / Źródło światła [LED]	Battery type / Rodzaj baterii	
82731	24+3	3x1.5V; AAA	12/48

EN LED work light
 PL Lampa robocza LED
 DE LED Handleuchte
 RU Светодиодный светильник для мастерской
 CS Ruční svítidla LED
 RO Lampa portabilă cu LED
 HU LED lámpa
 ES Lámpara de taller LED

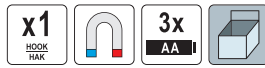

COB
 LED



No.	Battery type / Rodzaj baterii	
82726	3x1.5V; AA	12/48

EN UV LED flashlight and glasses set
 PL Zestaw latarka UV LED i okulary
 DE UV LED Taschenlampe mit UV Schutzbrille
 RU Комплект для проверки утечек хладагента - УФ фонарь с очками
 CS UV LED svítilna + brýle
 RO Set lanterna UV LED si ochelari
 HU UV LED zseblámpa + szemüveg
 ES UV LED linterna con gafas para

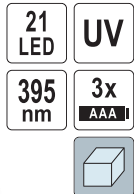

UV
 LED



No.	Light source / Źródło światła [LED]	Battery type / Rodzaj baterii	
82756	21	3x1.5V; AAA	80

EN LED flashlight
 PL Latarka LED
 DE LED Taschenlampe
 RU Светодиодный фонарь
 CS LED svítilna
 RO Lanterna cu LED
 HU LED zseblámpa
 ES Linterna LED

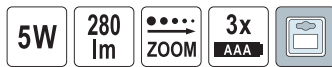

POWER
 LED



No.	Power / Moc [W]	Battery type / Rodzaj baterii	
88555	5	3x1.5V; AAA	12/48

EN LED work light
 PL Lampa robocza LED
 DE LED Handleuchte
 RU Светодиодный светильник для мастерской
 CS Ruční svítidla LED
 RO Lampa portabilă cu LED
 HU LED lámpa
 ES Lámpara de taller LED



LED



No.	Light source / Źródło światła [LED]	Battery type / Rodzaj baterii	
82735	36+1	4x1.5V; AAA	12/48

EN LED flashlight
 PL Latarka LED
 DE LED Taschenlampe
 RU Светодиодный фонарь
 CS LED svítilna
 RO Lanterna cu LED
 HU LED zseblámpa
 ES Linterna LED



POWER
 LED



No.	Power / Moc [W]	Battery type / Rodzaj baterii	
88560	10	3x1.5V; AA	12/24

EN Hydraulic bottle jack
 PL Podnośnik hydrauliczny słupkowy
 DE Hydraulischen Wagenheber
 RU Домкрат гидравлический „Бутылочный”

CS Pístový zvedák hydraulický
 RO Cric hidraulic cu piston
 HU Hidraulikus emelő
 ES Gato de embolo hidr.



No.	Max. lifting capacity / Maks. udźwig [t]	Lifting range / Zakres podnoszenia [mm]	
80012	2	140-260	6
80022	3	168-326	6
80032	5	185-355	4
80042	8	190-365	4
80052	10	195-375	4
80062	12	200-380	3
80072	15	205-390	2
80082	20	217-402	2

- EN Hydraulic floor jack
- PL Podnośnik hydrauliczny
- DE Hydraulischer Rangierwagenheber
- RU Домкрат гидравлический
- CS Pístový zvedák hydraulický
- RO Cric tip crocodil
- HU Krokodil emelő
- ES Gato hidráulico



No.	Max. lifting capacity / Maks. udźwig [t]	Lifting range / Zakres podnoszenia [mm]	Box icon
80111	2	135-340	1

- EN Scissors jack
- PL Podnośnik mechaniczny trapezowy
- DE Trapezwagenheber
- RU Домкрат механический ромбовый
- CS Lichoběžníkový zvedák
- RO Cric mecanic
- HU Trapézemelő
- ES Gato mecanico-trapezoidal



No.	Max. lifting capacity / Maks. udźwig [t]	Lifting range / Zakres podnoszenia [mm]	Box icon
80271	1.2	100-350	4

- EN Jack stand
- PL Podstawka pod samochód
- DE Unterstellbock
- RU Подставка для автомобиля
- CS Podstavec pod auto
- RO Chituc de metal
- HU Gépkocsi alátét
- ES Apoyos de coche



No.	Max. lifting capacity / Maks. udźwig [t]	Lifting range / Zakres podnoszenia [mm]	pcs / szt.	Box icon
80307	2	265-390	2	4
80308	3	275-415	2	4
80309	6	360-585	2	2

- EN Scissors jack
- PL Podnośnik mechaniczny trapezowy
- DE Trapezwagenheber
- RU Домкрат механический ромбовый
- CS Lichoběžníkový zvedák
- RO Cric mecanic
- HU Trapézemelő
- ES Gato mecanico-trapezoidal



No.	Max. lifting capacity / Maks. udźwig [t]	Lifting range / Zakres podnoszenia [mm]	Box icon
80252	1.5	95-390	5

- EN Jack stand
- PL Podstawka pod samochód
- DE Unterstellbock
- RU Подставка для автомобиля
- CS Podstavec pod auto
- RO Chituc de metal
- HU Gépkocsi alátét
- ES Apoyos de coche



No.	Max. lifting capacity / Maks. udźwig [t]	Lifting range / Zakres podnoszenia [mm]	Box icon
80300	2	250-380	5

- EN Jack stand
- PL Podstawka pod samochód
- DE Unterstellbock
- RU Подставка для автомобиля
- CS Podstavec pod auto
- RO Chituc de metal
- HU Gépkocsi alátét
- ES Apoyos de coche



No.	Max. lifting capacity / Maks. udźwig [t]	Lifting range / Zakres podnoszenia [mm]	pcs / szt.	Box icon
80312	2	280-370	2	5

EN Porta power repair kit
 PL Rozpieraak hydrauliczny
 DE Hydraulischer Richt und Ausbeulsatz
 RU Гидравлическая распорная стойка в наборе

CS Hydraulický rozpěrák
 RO Trusa pompa hidraulica + accesorii
 HU Hidraulikus bontó
 ES Cilindro de freno

4t

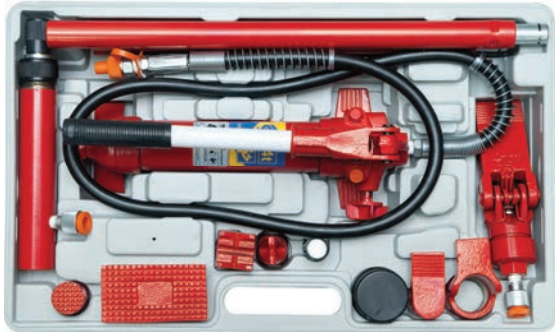

No.	Max. load capacity / Maks. obciążenie [t]	Icon
80402	4	1

EN Accessories for porta power
 PL Pompa do rozpieraka hydraulicznego
 DE Druckeinheit für Hydr. Spreizer
 RU Ручной насос для гидравлической распорной стойки
 CS Pumpa na hydraulický rozpěrák
 RO Pompa hidraulica
 HU Szivattyú hidraulikus bontóhoz
 ES Bomba para cilindro de freno



No.	Max. load capacity / Maks. obciążenie [t]	Icon
80320	4	2
80330	10	2

EN Accessories for porta power
 PL Siłownik do rozpieraka hydraulicznego
 DE Kraftzylinder für Hydr. Spreizer
 RU Сервомотор для гидравлической распорной стойки
 CS Servomotor na hydraulický rozpěrák
 RO Accesorii pompa hidraulica
 HU Erőátvitel a hidraulikus bontóhoz
 ES Servo para cilindro de freno



No.	Max. load capacity / Maks. obciążenie [t]	Icon
80340	4	4
80350	10	4

EN Porta power repair kit
 PL Rozpieraak hydrauliczny
 DE Hydraulischer Richt und Ausbeulsatz
 RU Гидравлическая распорная стойка в наборе

CS Hydraulický rozpěrák
 RO Trusa pompa hidraulica + accesorii
 HU Hidraulikus bontó
 ES Cilindro de freno

10t

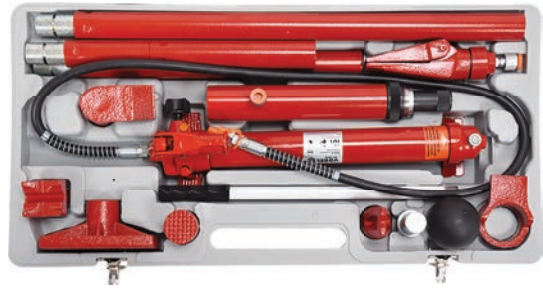

No.	Max. load capacity / Maks. obciążenie [t]	Icon
80412	10	1

EN Pull - back ram
 PL Ściągacz blacharski hydrauliczny
 DE Hydraulische Zugzylindereinheit
 RU Гидравлическая стяжка-крюк
 CS Klempříské stahovadlo hydraulické
 RO Carlig hidraulic tractare
 HU Hidraulikus lemezkihúzó
 ES Extractor de latonería de fontanero

10t 55 MPa 660 mm



No.	Max. load capacity / Maks. obciążenie [t]	Operating pressure / Ciśnienie robocze [MPa]	Icon
80450	10	55	4

EN Electronic battery charger
 PL Prostownik elektroniczny
 DE Elektronisches Ladegerät
 RU Электронное зарядное устройство
 CS Elektronická nabíječka
 RO Redresor electric
 HU Elektronikus akkumulátortöltő
 ES Cargador de batería para coche

max 4A CHARGING CURRENT PROJEKCIOWANE
 230V~50Hz
 12 V
 2.8 A
 8-60 Ah
 WET MOKRY
 LED DISPLAY WYŚWIETLACZ



No.	Charging voltage / Napięcie ładowania [V d.c.]	Charging current / Prąd ładowania [A]	Battery capacity / Pojemność akumulatora [Ah]	Icon
82541	12	2.8	8-60	10

EN Electronic battery charger
 PL Prostownik elektroniczny
 DE Elektronisches Ladegerät
 RU Электронное зарядное устройство
 CS Elektronická nabíječka
 RO Redresor electric
 HU Elektronikus akkumulátortöltő
 ES Cargador de batería para coche



max 6A CHARGING CURRENT PRĄD ŁADOWANIA
 230V~ 50Hz
 12V 4.2A
 12-90Ah WET MOKRY
 LED DISPLAY WYŚWIETLACZ

No.	Charging voltage / Napięcie ładowania [V d.c.]	Charging current / Prąd ładowania [A]	Battery capacity / Pojemność akumulatora [Ah]	
82542	12	4.2	12-90	10

EN Electronic battery charger
 PL Prostownik elektroniczny
 DE Elektronisches Ladegerät
 RU Электронное зарядное устройство
 CS Elektronická nabíječka
 RO Redresor electric
 HU Elektronikus akkumulátortöltő
 ES Cargador de batería para coche



max 12A CHARGING CURRENT PRĄD ŁADOWANIA
 230V~ 50Hz
 6V 12V
 10.3A 26-210Ah
 WET MOKRY LED DISPLAY WYŚWIETLACZ

No.	Charging voltage / Napięcie ładowania [V d.c.]	Charging current / Prąd ładowania [A]	Battery capacity / Pojemność akumulatora [Ah]	
82544	6/12	10.3	26-210	5

EN Pressure gauge
 PL Wskaźnik ciśnienia
 DE Druckanzeige
 RU Манометр
 CS Tlakomer
 RO Indicator de presiune
 HU Nyomásmérő
 ES Manómetro



0.05-0.75 MPa

No.	Measuring range / Zakres pomiaru [MPa/bar]	
82610	0.05-0.75 / 0.5-7.5	25/150

EN Pressure gauge
 PL Wskaźnik ciśnienia
 DE Druckanzeige
 RU Манометр
 CS Tlakomer
 RO Indicator de presiune
 HU Nyomásmérő
 ES Manómetro



No.	Measuring range / Zakres pomiaru [MPa/bar]	
82650	0.05-0.75 / 0.5-7.5	10/100

EN Electronic battery charger
 PL Prostownik elektroniczny
 DE Elektronisches Ladegerät
 RU Электронное зарядное устройство
 CS Elektronická nabíječka
 RO Redresor electric
 HU Elektronikus akkumulátortöltő
 ES Cargador de batería para coche



max 8A CHARGING CURRENT PRĄD ŁADOWANIA
 230V~ 50Hz
 6V 12V
 5.8A 12-120Ah
 WET MOKRY LED DISPLAY WYŚWIETLACZ

No.	Charging voltage / Napięcie ładowania [V d.c.]	Charging current / Prąd ładowania [A]	Battery capacity / Pojemność akumulatora [Ah]	
82543	6/12	5.8	12-120	5

EN Battery tester
 PL Tester akumulatorów
 DE Batterieprüfgerät
 RU Тестер аккумуляторов
 CS Tester akumulátorů
 RO Tester acumulatori
 HU Akkuteszter
 ES Tester para acumuladores



12V BATTERY TEST TEST AKUMULATORA ALTERNATOR TEST TEST ALTERNATORA

No.	
81741	24/48

EN Pressure gauge
 PL Wskaźnik ciśnienia
 DE Druckanzeige
 RU Манометр
 CS Tlakomer
 RO Indicator de presiune
 HU Nyomásmérő
 ES Manómetro



0.05-0.3 MPa

No.	Measuring range / Zakres pomiaru [MPa/bar]	
82611	0.05-0.3 / 0.5-3	10

0.05-0.75 MPa

- EN Chain block
- PL Wyciągarka łańcuchowa
- DE Kettenzug Flaschenzug
- RU Таль цепная
- CS Zvedák řetězový
- RO Scripete cu lant
- HU Láncos csigaszor emelő
- ES Cabria de cadena



No.	Max. load capacity / Maks. obciążenie [kg]	Chain length / Długość łańcucha [m]	
80751	1000	3	1
80752	2000	3	1
80753	3000	3	1

- EN Foot pump with gauge
- PL Pompka nożna z manometrem
- DE Fusspumpe
- RU Насос ножный с манометром
- CS Nožní pumpa s manometrem
- RO Pompă de picior cu manometru
- HU Lábpumpa nyomásmérővel
- ES Bomba de pierna con manometro



No.	Measuring range / Zakres pomiaru [MPa]	
82005	0-0.7	5

- EN Foot pump with gauge
- PL Pompka nożna z manometrem
- DE Fusspumpe
- RU Насос ножный с манометром
- CS Nožní pumpa s manometrem
- RO Pompă de picior cu manometru
- HU Lábpumpa nyomásmérővel
- ES Bomba de pierna con manometro



No.	Measuring range / Zakres pomiaru [MPa]	
82015	0-0.7	6

- EN Hand pump
- PL Pompka siłkowa ręczna
- DE Hand-Luftpumpe
- RU Насос ручной
- CS Hustilka ruční
- RO Pompa de mana
- HU Kézi pumpa
- ES Bomba de barrote de mano

0.3 MPa



No.	Measuring range / Zakres pomiaru [MPa]	
82020	0-0.3	20

- EN Hand pump with manometer
- PL Pompka siłkowa z manometrem
- DE Hand-Luftpumpe mit Manometer
- RU Насос ручной с манометром
- CS Pumpa s manometrem
- RO Pompa de mana cu manometru
- HU Kézi pumpa manométerrel
- ES Bomba de barrote con manometro



No.	Measuring range / Zakres pomiaru [MPa]	
82021	0-1	10

0-1 MPa



- EN Hand pump with manometer
- PL Pompka siłkowa z manometrem
- DE Hand-Luftpumpe mit Manometer
- RU Насос ручной с манометром
- CS Pumpa s manometrem
- RO Pompa de mana cu manometru
- HU Kézi pumpa manométerrel
- ES Bomba de barrote con manometro



No.	Measuring range / Zakres pomiaru [MPa]	
82022	0.1-1	10

0-1.1 MPa

60 cm

UNIVERSAL DOUBLE HEAD UNIVERSALNA GŁOWIKA PODWOJNA



- EN Foot pump with gauge
- PL Pompka nożna z manometrem
- DE Fusspumpe
- RU Насос ножный с манометром

- CS Nožní pumpa s manometrem
- RO Pompă de picior cu manometru
- HU Lábpumpa nyomásmérővel
- ES Bomba de pierna con manometro



No.	
82000	20

- EN Foot pump with gauge
- PL Pompka nożna z manometrem
- DE Fusspumpe
- RU Насос ножный с манометром

- CS Nožní pumpa s manometrem
- RO Pompă de picior cu manometru
- HU Lábpumpa nyomásmérővel
- ES Bomba de pierna con manometro

0-0.7 MPa

UNIVERSAL DOUBLE HEAD UNIVERSALNA GŁOWIKA PODWOJNA



No.	Measuring range / Zakres pomiaru [MPa]	
82001	0-0.7	12



0-0.7 MPa

UNIVERSAL DOUBLE HEAD UNIVERSALNA GŁOWIKA PODWOJNA

TWIN PISTON PODWOJNY TŁOK



- EN Car air compressor
- PL Kompresor samochodowy
- DE Auto-Kompressor
- RU Автомобильный компрессор
- CS Automobilový kompresor
- RO Compresor auto
- HU Autókompresszor
- ES Compresor de coche



120 W	12 V	25 l/min
1.0 MPa	46 cm	3 m

STACOR

No.	Voltage / Napięcie [V d.c.]	Power / Moc [W]	
82105	12	120	36

- EN Air wedge
- PL Poduszka montażowa
- DE Luft Keil
- RU Монтажная подушка для установки окон и дверей
- CS Zvedací vzduchové měchy
- RO Perna de aer
- HU Emelőpárna
- ES Cojines elevadores



50 mm ↑
max 135 kg
TPU

VOREL

No.	Size / Rozmiar [mm]	
39000	160x160	120
39001	190x115	120
39002	130x270	60

- EN Car air compressor
- PL Kompresor samochodowy
- DE Auto-Kompressor
- RU Автомобильный компрессор
- CS Automobilový kompresor
- RO Compresor auto
- HU Autókompresszor
- ES Compresor de coche



120 W	12 V	35 l/min	1.0 MPa
1 m	3 m		

STACOR

No.	Voltage / Napięcie [V d.c.]	Power / Moc [W]	
82107	12	120	8

- EN Air pump wedge set
- PL Zestaw poduszek montażowych
- DE Montagekissen-Set
- RU Набор монтажных подушек
- CS Rozplínací polštářky
- RO Set perne de aer
- HU Szerelőpárna készlet
- ES Juego de bolsas de cuña de aire

2 PCS	50 mm ↑	max 135 kg
TPU		



VOREL

No.	Size / Rozmiar [mm]	pcs / szt.	
39005	190x115, 130x270	2	60

14

- EN Tow rope
- PL Linka holownicza
- DE Abschleppseil
- RU Трос автомобильный буксировочный
- CS Těžný provázek
- RO Șufă pt. remorcare
- HU Vonatökötél
- ES Cable de remolque



VOREL

No.	Gross vehicle mass GVM / Dopuszczalna masa całkowita pojazdu DMC [kg]	
82201	1500	20

- EN Tow rope
- PL Linka holownicza
- DE Abschleppseil
- RU Трос автомобильный буксировочный
- CS Těžný provázek
- RO Șufă pt. remorcare
- HU Vonatökötél
- ES Cable de remolque



VOREL

No.	Gross vehicle mass GVM / Dopuszczalna masa całkowita pojazdu DMC [kg]	
82205	2500	10

- EN Tow rope
- PL Linka holownicza
- DE Abschleppseil
- RU Трос автомобильный буксировочный
- CS Těžný provázek
- RO Șufă pt. remorcare
- HU Vonatökötél
- ES Cable de remolque



5m

- EN Tow rope
- PL Linka holownicza
- DE Abschleppseil
- RU Трос автомобильный буксировочный
- CS Těžný provázek
- RO Șufă pt. remorcare
- HU Vonatökötél
- ES Cable de remolque



VOREL

No.	Gross vehicle mass GVM / Dopuszczalna masa całkowita pojazdu DMC [kg]	
82209	2500	8

VOREL

No.	Gross vehicle mass GVM / Dopuszczalna masa całkowita pojazdu DMC [kg]	
82200	3500	12

EN Tow rope
 PL Linka holownicza
 DE Abschleppseil
 RU Трос автомобильный буксировочный
 CS Těžný provázek
 RO Șufă pt. remorcare
 HU Vonatókötél
 ES Cable de remolque

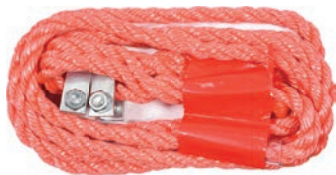

No.	Gross vehicle mass GVM / Dopuszczalna masa całkowita pojazdu DMC [kg]	
82206	3500	12

EN Tow rope
 PL Linka holownicza
 DE Abschleppseil
 RU Трос автомобильный буксировочный
 CS Těžný provázek
 RO Șufă pt. remorcare
 HU Vonatókötél
 ES Cable de remolque



No.	Gross vehicle mass GVM / Dopuszczalna masa całkowita pojazdu DMC [kg]	
82227	3500	20

EN Tow rope
 PL Linka holownicza z szeklą
 DE Abschleppseil
 RU Трос автомобильный буксировочный
 CS Těžný provázek
 RO Șufă pt. remorcare
 HU Vonatókötél
 ES Cable de remolque



No.	Gross vehicle mass GVM / Dopuszczalna masa całkowita pojazdu DMC [kg]	
82234	3500	12

EN Tow rope
 PL Linka holownicza z hakiem
 DE Abschleppseil
 RU Трос автомобильный буксировочный
 CS Těžný provázek
 RO Șufă pt. remorcare
 HU Vonatókötél
 ES Cable de remolque



No.	Gross vehicle mass GVM / Dopuszczalna masa całkowita pojazdu DMC [kg]	
82233	2500	16

EN Tow rope
 PL Linka holownicza
 DE Abschleppseil
 RU Трос автомобильный буксировочный
 CS Těžný provázek
 RO Șufă pt. remorcare
 HU Vonatókötél
 ES Cable de remolque



No.	Gross vehicle mass GVM / Dopuszczalna masa całkowita pojazdu DMC [kg]	
82225	2500	20

EN Tow rope
 PL Linka holownicza z szeklą
 DE Abschleppseil
 RU Трос автомобильный буксировочный
 CS Těžný provázek
 RO Șufă pt. remorcare
 HU Vonatókötél
 ES Cable de remolque



No.	Gross vehicle mass GVM / Dopuszczalna masa całkowita pojazdu DMC [kg]	
82232	2500	16

EN Tow rope
 PL Linka holownicza z hakiem
 DE Abschleppseil
 RU Трос автомобильный буксировочный
 CS Těžný provázek
 RO Șufă pt. remorcare
 HU Vonatókötél
 ES Cable de remolque



No.	Gross vehicle mass GVM / Dopuszczalna masa całkowita pojazdu DMC [kg]	
82231	1500	20

EN Battery clamps cleaner
 PL Szczotka do czyszczenia klemm
 DE Klemmbürste
 RU Щетка для зачистки клемм
 CS Kartáč pro čištění svorek
 RO Perie curatat borne auto
 HU Akkumulátorsaru tisztító kefe
 ES Cepillo para limpiar bornes



No.	
82440	10/160

- EN Battery clamps cleaner
- PL Szczotka do czyszczenia klem
- DE Klemmbürste
- RU Щетка для зачистки клемм
- CS Kartáč pro čištění svorek
- RO Perie curatat borne auto
- HU Akkumulátorsaru tisztító kefe
- ES Cepillo para limpiar bornes



VOREL

No.		
82445		10/100

- EN Battery hydrometer
- PL Próbnik akumulatorowy
- DE Batteriesäureprüfer
- RU Ареометр аккумуляторный
- CS Akumulátorový zkoušeč
- RO Instrument de verificare acumulator
- HU Akkumulátorpróbaló
- ES Probador de acumulador



No.		
82520		10/100

- EN Car window scraper
- PL Skrobaczka do szyb
- DE Auto-Eiskratzer
- RU Автомобильный скребок
- CS Škrabka na okna
- RO Razuitoar gheata
- HU Jégkaparó
- ES Rascadora para cristales

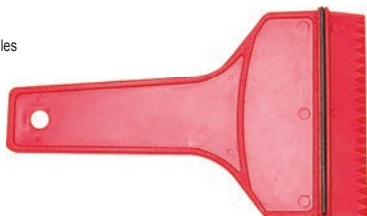

No.		
82910		100

- EN Flexible funnel
- PL Lejek
- DE Trichter
- RU Воронка гибкая
- CS Nálevka
- RO Pálnie
- HU Kétrészes tölcser
- ES Embudo



VOREL

No.		
83000		30

- EN Battery clamps
- PL Komplet klem do akumulatora
- DE Akku-Polklemmen
- RU Клеммы аккумуляторные
- CS Sada svorek na akumulátor
- RO Set de cleme pt. acumulator
- HU Akkumulátorsaru készlet
- ES Juego de bornes para acumulador



VOREL

No.	pcs / szt.	
82431	2	12/120

- EN Boosters cables
- PL Wiązka przewodów awaryjnych
- DE Starthilfekabel
- RU Старт-кабель
- CS Spouštěcí kabele
- RO Cabluri de alimentare
- HU Indítókábel
- ES Pinzas de arranque



No.	Rated load / Obciążenie nominalne [A]	
82502	200	6
82504	400	6
82506	600	6

- EN Window squeegee
- PL Guma do szyb z drewnianą rączką
- DE Scheibenreiniger-Holzstiel
- RU Стеклоочиститель с резиной
- CS Guma do skel z dřevěnou rukojetí
- RO Lamă-ștergător cu miner de lemn pt. geamuri
- HU Vízlehúzó gumi fa nyéllel
- ES Goma para cristales con mango de madera

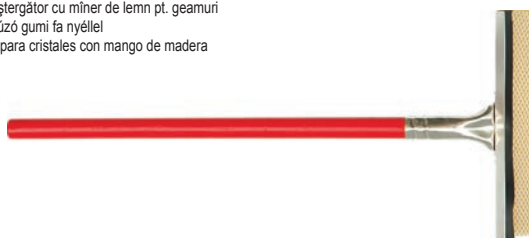

No.		
82920		50

- EN Flexible funnel
- PL Lejek
- DE Trichter
- RU Воронка гибкая
- CS Nálevka
- RO Pálnie
- HU Kétrészes tölcser
- ES Embudo



VOREL

No.		
83001		30

EN Flexible funnel CS Nálevka
 PL Lejek RO Pálnie
 DE Trichter HU Kétrészes tölcser
 RU Воронка гибкая ES Embudo



VOREL

No.		
83002		30

EN Agricultural funnel
 PL Lejek rolniczy
 DE Trichter
 RU Воронка гибкая
 CS Nálevka
 RO Pálnie
 HU Kétrészes tölcser
 ES Embudo



VOREL

No.	Ø [mm]	
83004	210	25

EN Car vacuum cleaner
 PL Odkurzacz samochodowy
 DE Handsauger
 RU Ручной пылесос для автомобиля
 CS Vysavač do auta
 RO Aspirator de masina
 HU Autó porszívó
 ES Aspirador para coche



LUND

No.	Battery voltage / Napiecie akumulatora [V d.c.]	Power / Moc [W]	
82955	7.4	60	30

EN Car vacuum cleaner
 PL Odkurzacz samochodowy
 DE Handsauger
 RU Ручной пылесос для автомобиля
 CS Vysavač do auta
 RO Aspirator de masina
 HU Autó porszívó
 ES Aspirador para coche



STHOR

No.	Voltage / Napiecie [V d.c.]	Power / Moc [W]	
82952	12	100	20

EN Funnel CS Nálevka
 PL Lejek RO Pálnie
 DE Trichter HU Kétrészes tölcser
 RU Воронка гибкая ES Embudo



VOREL

No.	Ø [mm]	H [mm]	pcs / szt.	
83005	52, 76, 100, 120	75, 110, 125, 152	4	30

EN Car vacuum cleaner
 PL Odkurzacz samochodowy
 DE Handsauger
 RU Ручной пылесос для автомобиля
 CS Vysavač do auta
 RO Aspirator de masina
 HU Autó porszívó
 ES Aspirador para coche

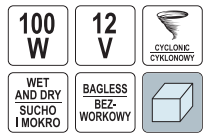

STHOR

No.	Voltage / Napiecie [V d.c.]	Power / Moc [W]	
82951	12	100	8

EN Car vacuum cleaner
 PL Odkurzacz samochodowy
 DE Handsauger
 RU Ручной пылесос для автомобиля
 CS Vysavač do auta
 RO Aspirator de masina
 HU Autó porszívó
 ES Aspirador para coche

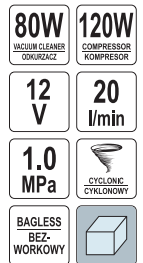

STHOR

No.	Voltage / Napiecie [V d.c.]	Vacuum cleaner power / Moc odkurzacza [W]	Compressor power / Moc kompresora [W]	
82953	12	80	120	12

EN Car vacuum cleaner
 PL Odkurzacz samochodowy
 DE Handsauger
 RU Ручной пылесос для автомобиля
 CS Vysavač do auta
 RO Aspirator de masina
 HU Autó porszívó
 ES Aspirador para coche



100 W 12 V
 CYCLONIC CYKLONOWY BAGLESS BEZ-WORKOWY
 3m



No.	Voltage / Napięcie [V d.c.]	Power / Moc [W]	
82967	12	100	9

EN Rechargeable car vacuum cleaner
 PL Odkurzacz samochodowy bezprzewodowy
 DE Kabelloser Auto-Staubsauger
 RU Беспроводной пылесос автомобиля
 CS Bezdrátový automobilový vysavač
 RO Aspirator de mașină fără fir
 HU Vezeték nélküli autós porszívó
 ES Aspirador de coche inalámbrico



100 W 2600 mAh Li-Ion
 5-6h 15-18 min
 USB BATTERY CHARGER LADOWARKA CYCLONIC CYKLONOWY
 BAGLESS BEZ-WORKOWY



No.	Voltage / Napięcie [V d.c.]	Power / Moc [W]	
82970	5	100	9

EN Portable car shower set
 PL Samochodowy prysznic turystyczny
 DE Campingdusche
 RU Портативный автомобиль душ
 CS Mobilní auto sprcha
 RO Dus portabil masina
 HU Autós hordozható zuhany
 ES Portátil ducha de coche

FUNCTIONS:
 - Taking shower, washing car, washing dishes and others

FUNKCJE:
 - Prysznic, mycie samochodu, mycie naczyń i inne



12 V 10 l/min
 FLOW REGULATION PRZEPŁYW HOSE WĄZ
 2m 4m



No.	Voltage / Napięcie [V d.c.]	
82991	12	5/10

EN Car vacuum cleaner
 PL Odkurzacz samochodowy
 DE Handsauger
 RU Ручной пылесос для автомобиля
 CS Vysavač do auta
 RO Aspirator de masina
 HU Autó porszívó
 ES Aspirador para coche



80 W 7.4 V 2000mAh Li-Ion 4h
 20min CYCLONIC CYKLONOWY BAGLESS BEZ-WORKOWY



No.	Voltage / Napięcie [V d.c.]	Power / Moc [W]	
82954	7.4	80	20

EN Rechargeable car vacuum cleaner
 PL Odkurzacz samochodowy bezprzewodowy
 DE Kabelloser Auto-Staubsauger
 RU Беспроводной пылесос автомобиля
 CS Bezdrátový automobilový vysavač
 RO Aspirator de mașină fără fir
 HU Vezeték nélküli autós porszívó
 ES Aspirador de coche inalámbrico



100 W 2600 mAh Li-Ion
 5-6h 15-18 min
 USB BATTERY CHARGER LADOWARKA CYCLONIC CYKLONOWY
 BAGLESS BEZ-WORKOWY



No.	Voltage / Napięcie [V d.c.]	Power / Moc [W]	
82971	5	100	9

EN Portable car shower set
 PL Samochodowy prysznic turystyczny
 DE Campingdusche
 RU Портативный автомобиль душ
 CS Mobilní auto sprcha
 RO Dus portabil masina
 HU Autós hordozható zuhany
 ES Portátil ducha de coche

FUNCTIONS:
 - Taking shower, washing car, washing dishes, watering plants and others

FUNKCJE:
 - Prysznic, mycie samochodu, mycie naczyń, podlewanie roślin i inne



12 V 20 l/min
 2m 4m HOSE WĄZ



No.	Voltage / Napięcie [V d.c.]	
82992	12	10

EN First aid kit
PL Apteczka samochodowa
DE Verbandkasten
RU Аптечка автомобильная

CS Příruční lékárnička první pomoci
RO Trusă medicală de prim-ajutor
HU Elsősegély doboz
ES Botiquín



No.	Type / Typ	
83260	E-01	10

EN First aid kit
PL Apteczka samochodowa
DE Verbandkasten
RU Аптечка автомобильная
CS Příruční lékárnička první pomoci
RO Trusă medicală de prim-ajutor
HU Elsősegély doboz
ES Botiquín

CS Příruční lékárnička první pomoci
RO Trusă medicală de prim-ajutor
HU Elsősegély doboz
ES Botiquín



No.	Type / Typ	
83262	E-03	5

EN Metal first aid kit
PL Apteczka metalowa
DE Apotheke aus Metall
RU Металлическая аптечка

CS Kovová lékárnička
RO Trusă medicală din metal
HU Fém elsősegély doboz
ES Botiquín de metal



No.	Type / Typ	Dimensions / Wymiary [mm]	
83267	E300	300x220x120	1

EN Elastic tie down
PL Spinacz bagażu
DE Gepäckspinnensatz
RU Стяжка для багажа
CS Elastické spínatka
RO Cordelina elastica
HU Csomagrögzítő pók
ES Pulpo 8-ramion

CS Elastické spínatka
RO Cordelina elastica
HU Csomagrögzítő pók
ES Pulpo 8-ramion



No.	L [cm]	Ø [mm]	Arm quantity / Liczba ramion	
82300	80	8	8	25/50

EN First aid kit
PL Apteczka samochodowa
DE Verbandkasten
RU Аптечка автомобильная

CS Příruční lékárnička první pomoci
RO Trusă medicală de prim-ajutor
HU Elsősegély doboz
ES Botiquín



No.	Type / Typ	
83261	E-04	5

EN Metal first aid kit
PL Apteczka metalowa
DE Apotheke aus Metall
RU Металлическая аптечка
CS Kovová lékárnička
RO Trusă medicală din metal
HU Fém elsősegély doboz
ES Botiquín de metal

CS Kovová lékárnička
RO Trusă medicală din metal
HU Fém elsősegély doboz
ES Botiquín de metal



No.	Type / Typ	Dimensions / Wymiary [mm]	
83266	E240	240x220x120	1

EN Vehicle safety triangle
PL Trójkąt ostrzegawczy
DE Warndreieck
RU Предупреждающий треугольник
CS Výstražný trojúhelník
RO Triunghi de avertizare
HU Elakadásjelző háromszög
ES Triángulo de emergencia



No.	
83280	40

EN Elastic tie down
PL Spinacz bagażu
DE Gepäckspinnensatz
RU Стяжка для багажа
CS Elastické spínatka
RO Cordelina elastica
HU Csomagrögzítő pók
ES Pulpo 8-ramion



No.	L [cm]	Ø [mm]	Arm quantity / Liczba ramion	
82301	80	8	8	25/50

EN Elastic straps
 PL Ściągacze elastyczne
 DE Gummispannseil
 RU Стяжка для багажа
 CS Elastické spínatka
 RO Cordelina elastica
 HU Rugalmas feszítő
 ES Pulpos



No.	L [cm]	Ø [mm]	pcs / szt.	
82308	80	8	2	20/80
82310	100	8	2	20/80
82315	150	8	2	20/80
82320	200	8	2	25/50

EN Elastic straps
 PL Płaskie ściągacze elastyczne
 DE Gummispannseil
 RU Стяжка для багажа
 CS Elastické spínatka
 RO Cordelina elastica
 HU Rugalmas feszítő
 ES Pulpos



No.	L [cm]	pcs / szt.	
82360	80	2	25/50
82370	100	2	20/80

14

EN Ratchet tie down
 PL Taśma do bagażu ze sprzączką
 DE Spanngurt
 RU Ремни для крепления груза с зажимом фиксатором
 CS Pás na zavazadla
 RO Cordelina pt. bagaje cu clicheț
 HU Csomagrögzítő pánt
 ES Cintas para equipaje



No.	L [m]	W [mm]	
82341	5	25	12/48

EN Ratchet tie down
 PL Taśma do bagażu
 DE Spanngurt
 RU Ремень для крепления багажа с трещоткой

CS Pás na zavazadla z napínáním
 RO Cordelina pt. bagaje cu clicheț
 HU Csomagrögzítő pánt feszítővel
 ES Cinta para equipaje con carraca

No.	L [m]	W [mm]	Lashing capacity / Zdolność mocowania [daN]	
82372	4	50	1600	8
82373	6	50	1600	7
82374	8	50	1600	6
82375	10	50	1600	5
82384	6	50	2000	6
82386	8	50	2000	6
82388	10	50	2000	5
82390	12	50	2000	5

EN Elastic straps
 PL Ściągacze elastyczne
 DE Gummispannseil
 RU Стяжка для багажа
 CS Elastické spínatka
 RO Cordelina elastica
 HU Rugalmas feszítő
 ES Pulpos



No.	L [cm]	Ø [mm]	pcs / szt.	
82305	120	12	2	12/24

EN Ratchet tie down
 PL Taśma do bagażu ze sprzączką
 DE Spanngurt
 RU Ремни для крепления груза с зажимом фиксатором
 CS Pás na zavazadla
 RO Cordelina pt. bagaje cu clicheț
 HU Csomagrögzítő pánt
 ES Cintas para equipaje

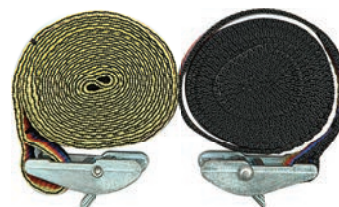
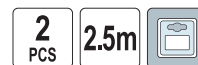

No.	L [m]	W [mm]	pcs / szt.	
82331	2.5	25	2	10/80

EN Ratchet tie down
 PL Taśma do bagażu
 DE Spanngurt
 RU Ремень для крепления багажа с трещоткой
 CS Pás na zavazadla z napínáním
 RO Cordelina pt. bagaje cu clicheț
 HU Csomagrögzítő pánt feszítővel
 ES Cinta para equipaje con carraca



No.	L [m]	W [mm]	Lashing capacity / Zdolność mocowania [daN]	
82377	2	35	1000	10
82378	4	35	1000	10
82379	6	35	1000	10
82380	8	35	1000	10



EN Ratchet tie down
 PL Taśma do bagażu
 DE Spanggurt
 RU Ремень для крепления багажа с трещоткой
 CS Pás na zavazadla z napínáním
 RO Cordelina pt. bagaje cu clichet
 HU Csomagrögzítő pánt feszítővel
 ES Cinta para equipaje con carraca

2
PCS
✕



No.	L [m]	W [mm]	Lashing capacity / Zdolność mocowania [daN]	📦
82392	6	50	2500	6
82393	8	50	2500	6
82395	12	50	2500	5

EN Ratchet tie down
 PL Taśma do bagażu
 DE Spanggurt
 RU Ремень для крепления багажа с трещоткой
 CS Pás na zavazadla z napínáním
 RO Cordelina pt. bagaje cu clichet
 HU Csomagrögzítő pánt feszítővel
 ES Cinta para equipaje con carraca

2
PCS
✕



VOREL

No.	L [m]	W [mm]	Lashing capacity / Zdolność mocowania [daN]	📦
82401	2	38	1000	12
82402	4	38	1000	12
82403	6	38	1000	12
82404	8	38	1000	12
82405	4	50	1500	6
82406	6	50	1500	6
82407	8	50	1500	6
82408	10	50	1500	6
82409	6	50	2000	6
82410	8	50	2000	6
82411	10	50	2000	6
82412	12	50	2000	6
82413	6	50	2500	6
82414	8	50	2500	6
82415	10	50	2500	6

EN Ratchet tie down
 PL Taśma do bagażu
 DE Spanggurt
 RU Ремень для крепления багажа с трещоткой
 CS Pás na zavazadla z napínáním
 RO Cordelina pt. bagaje cu clichet
 HU Csomagrögzítő pánt feszítővel
 ES Cinta para equipaje con carraca

✕



No.	L [m]	W [mm]	Lashing capacity / Zdolność mocowania [daN]	📦
82343	4	25	1000	20

EN Ratchet tie down
 PL Taśma do bagażu
 DE Spanggurt
 RU Ремень для крепления багажа с трещоткой
 CS Pás na zavazadla z napínáním
 RO Cordelina pt. bagaje cu clichet
 HU Csomagrögzítő pánt feszítővel
 ES Cinta para equipaje con carraca

5m
📦



VOREL

No.	L [m]	W [mm]	📦
82351	5	25	12/48

EN Ratchet tie down
 PL Taśma do bagażu
 DE Spanggurt
 RU Ремень для крепления багажа с трещоткой
 CS Pás na zavazadla z napínáním
 RO Cordelina pt. bagaje cu clichet
 HU Csomagrögzítő pánt feszítővel
 ES Cinta para equipaje con carraca

2
PCS
5m
📦



VOREL

No.	L [m]	W [mm]	pcs / szt.	📦
82400	5	25	2	8/16

EN Ratchet tie down
 PL Taśma do bagażu
 DE Spanggurt
 RU Ремень для крепления багажа с трещоткой
 CS Pás na zavazadla z napínáním
 RO Cordelina pt. bagaje cu clichet
 HU Csomagrögzítő pánt feszítővel
 ES Cinta para equipaje con carraca

2
PCS
✕



No.	L [m]	W [mm]	Lashing capacity / Zdolność mocowania [daN]	📦
82397	5	25	500	20

EN Customs securing rope RU Стальной таможенный трос HU Acél árubiztosító kótél
 PL Linka celna stalowa CS Ocelové celní lanko ES Cable de acero de seguridad
 DE Zollschnur aus Stahl RO Cablu de ancorare



No.	Ø [mm]	L [m]	
85000	6	15	12
85001	6	16	12
85002	6	18	12
85003	6	34	12
85004	6	36	12
85005	6	42	10



EN Luggage net
 PL Siatka organizer z hakami do bagażnika
 DE Organizer Gepäcknetz mit Haken für Kofferraum
 RU Сетка-организайзер с крючками для багажника
 CS Síťka organizér zavazadlového prostoru s háčky
 RO Plasa pt. bagaje
 HU Rendszerező csomagtartó hálókampókkal
 ES Red organizador con ganchos para maletero

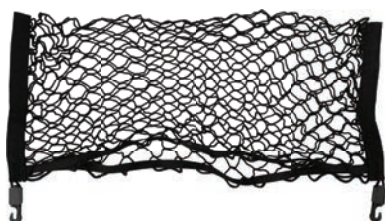

No.	Size / Rozmiar [mm]	
82260	700x300	24

EN Luggage net
 PL Siatka organizer do bagażnika z hakami
 DE Organizer Gepäcknetz mit Haken für Kofferraum
 RU Сетка-организайзер для багажника с крючками
 CS Síťka organizér zavazadlového prostoru s háčky
 RO Plasa pt. bagaje
 HU Rendszerező csomagtartó hálókampókkal
 ES Red organizador para maletero, con ganchos

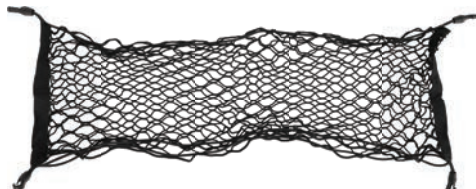

No.	Size / Rozmiar [mm]	
82262	900x300	50

EN Tarpaulin CS Plachta
 PL Plandeka RO Husă
 DE Plane HU PONYVA
 RU Тент ES Toldo



No.	Size / Rozmiar [m]	m [g/m²]	
85122	2x3	57	30
85123	3x5	57	20
85124	4x5	57	10
85125	4x6	57	8
85126	5x8	57	5
85128	6x10	57	3
85129	8x12	57	2
85130	10x15	57	2

EN Luggage net
 PL Siatka do bagażnika z hakami
 DE Gepäcknetz mit Haken für Kofferraum
 RU Сетка с крючками для багажника
 CS Síťka do zavazadlového prostoru s háčky
 RO Plasa pt. bagaje
 HU Csomagtartó hálókampókkal
 ES Red con ganchos para maletero



No.	Size / Rozmiar [mm]	
82261	900x900	50

EN Elastic tie down
 PL Ściągacze elastyczne z karabinczykiem
 DE Elastische Abzieher mit Karabinerhaken
 RU Эластичные шнуры для затягивания с карабином
 CS Elastické stahovky s karabinkou
 RO Cordelina elastica pt. bagaje
 HU Rugalmas kótél karabinerekkel
 ES Elásticos con mosquetón

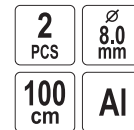

No.	Ø [mm]	L [mm]	pcs / szt.	
82322	8	1000	2	30

EN Tarpaulin
 PL Plandeka
 DE Plane
 RU Тент
 CS Plachta
 RO Husă
 HU PONYVA
 ES Toldo



No.	Size / Rozmiar [m]	m [g/m²]	
85131	2x3	57	30
85132	3x5	57	20
85133	4x5	57	10
85134	4x6	57	8
85135	5x8	57	5

EN Tarpaulin CS Plachta
 PL Plandeka RO Husă
 DE Plane HU Ponyva
 RU Тент ES Toldo

75 g/m²



No.	Size / Rozmiar [m]	m [g/m ²]	☐
85112	2x3	75	30
85113	3x5	75	10
85114	4x5	75	10
85115	4x6	75	8
85116	5x8	75	5
85118	6x10	75	3
85119	8x12	75	2
85120	10x15	75	2

EN Tarpaulin clips
 PL Uchwyty zaciskowe ze śrubą do mocowania plandek
 DE Kunststoff Planenhalter
 RU Пластиковый клипс зажим для палаток и тентов
 CS Držáky k zakrývacím plachtám
 RO Clame pt. prelate
 HU Ponyvarógzító klipsz
 ES Pinzas para lonas

8 PCS NYLON
 FOR TARPAILLINS DO PLANDEK



No.	pcs / szt.	☐
85170	8	12/48

EN Tarpaulin clips
 PL Uchwyty zaciskowe do mocowania plandek
 DE Kunststoff Planenhalter
 RU Пластиковый клипс зажим для палаток и тентов
 CS Držáky k zakrývacím plachtám
 RO Clame pt. prelate
 HU Ponyvarógzító klipsz
 ES Pinzas para lonas

8 PCS PE
 FOR TARPAILLINS DO PLANDEK



No.	pcs / szt.	☐
85174	8	12/48

GB Ball bungee cords
 PL Guma mocująca z kulką
 DE Planenspanner Spanngummi mit Kunststoffkugel
 RU Резиновая петля с шариком
 CZ Upinací gumy s plastovou kuličkou
 RO Cordelina elastica cu bila fixare
 HU Ponyva rögzítő gumipók
 ES Tensor de goma con bola de plástico



No.	pcs / szt.	☐
85180	8	24/96

EN Tarpaulin CS Plachta
 PL Plandeka RO Husă
 DE Plane HU Ponyva
 RU Тент ES Toldo

90 g/m²



No.	Size / Rozmiar [m]	m [g/m ²]	☐
85020	2x3	90	30
85030	3x5	90	18
85040	4x5	90	9
85050	4x6	90	10
85060	5x8	90	5
85080	6x10	90	4
85090	8x12	90	2
85100	10x15	90	1

EN Tarpaulin clips
 PL Uchwyty zaciskowe do mocowania plandek
 DE Kunststoff Planenhalter
 RU Пластиковый клипс зажим для палаток и тентов
 CS Držáky k zakrývacím plachtám
 RO Clame pt. prelate
 HU Ponyvarógzító klipsz
 ES Pinzas para lonas

8 PCS PP
 FOR TARPAILLINS DO PLANDEK



No.	pcs / szt.	☐
85172	8	72

EN Elastic rope
 PL Linka pleciona, elastyczna
 DE Polypropylen-Gummileine
 RU Шнур эластичный
 CS Lano opletené elastické
 RO Funie elastica
 HU Rugalmas kótél
 ES Cuerda trenzada

8.0 mm PP RUBBER CORE GUMOWY RDZEN FOR TARPAILLINS DO PLANDEK



No.	Ø [mm]	L [mm]	☐
85177	8	15	20
85178	8	30	8

8 PCS Ø 25 mm
 200 mm FOR TARPAILLINS DO PLANDEK



- EN Metal pegs for fixing tarpaulins
- PL Szpilki stalowe do mocowania plandek
- DE Metallhaken zum Befestigen von Planen
- RU Металлические колышки для шнуров растяжки тентов и палаток
- CS Kolíky pro plachtoviny
- RO Carligi metalice pt. prelate
- HU Napellenző csapok
- ES Piqueta para lonas

10 PCS	∅ 6,0 mm	180 mm	FOR TARPAULINS DO PLANDEK	
-----------	----------------	-----------	------------------------------------	--

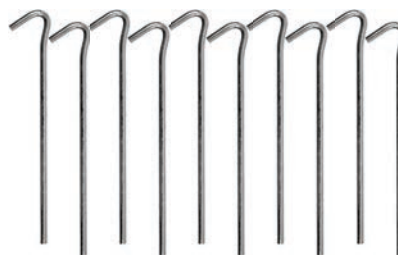

No.	pcs / szt.	
85185	10	18/36

- EN Tarpaulin repair tape
- PL Taśma klejąca do naprawy plandek
- DE Planen-Reparatur-Klebeband
- RU Самоклеящаяся лента тарпаулиновая, для ремонта тентов
- CS Páska maskovací textilní pro plachtoviny
- RO Bandă adezivă de reparații pt. prelate
- HU Szövetszalag ezüst
- ES Cinta adhesiva de reparación para lonas

8m 50mm	DUCT	
FOR TARPAULINS DO PLANDEK		



No.	W [mm]	L [m]	
85190	50	8	72

- EN Tarpaulin repair tape
- PL Taśma klejąca do naprawy plandek
- DE Planen-Reparatur-Klebeband
- RU Самоклеящаяся лента тарпаулиновая, для ремонта тентов
- CS Páska maskovací textilní pro plachtoviny
- RO Bandă adezivă de reparații pt. prelate
- HU Szövetszalag ezüst
- ES Cinta adhesiva de reparación para lonas

8m 50mm	DUCT	
FOR TARPAULINS DO PLANDEK		



No.	W [mm]	L [m]	
85191	50	8	72

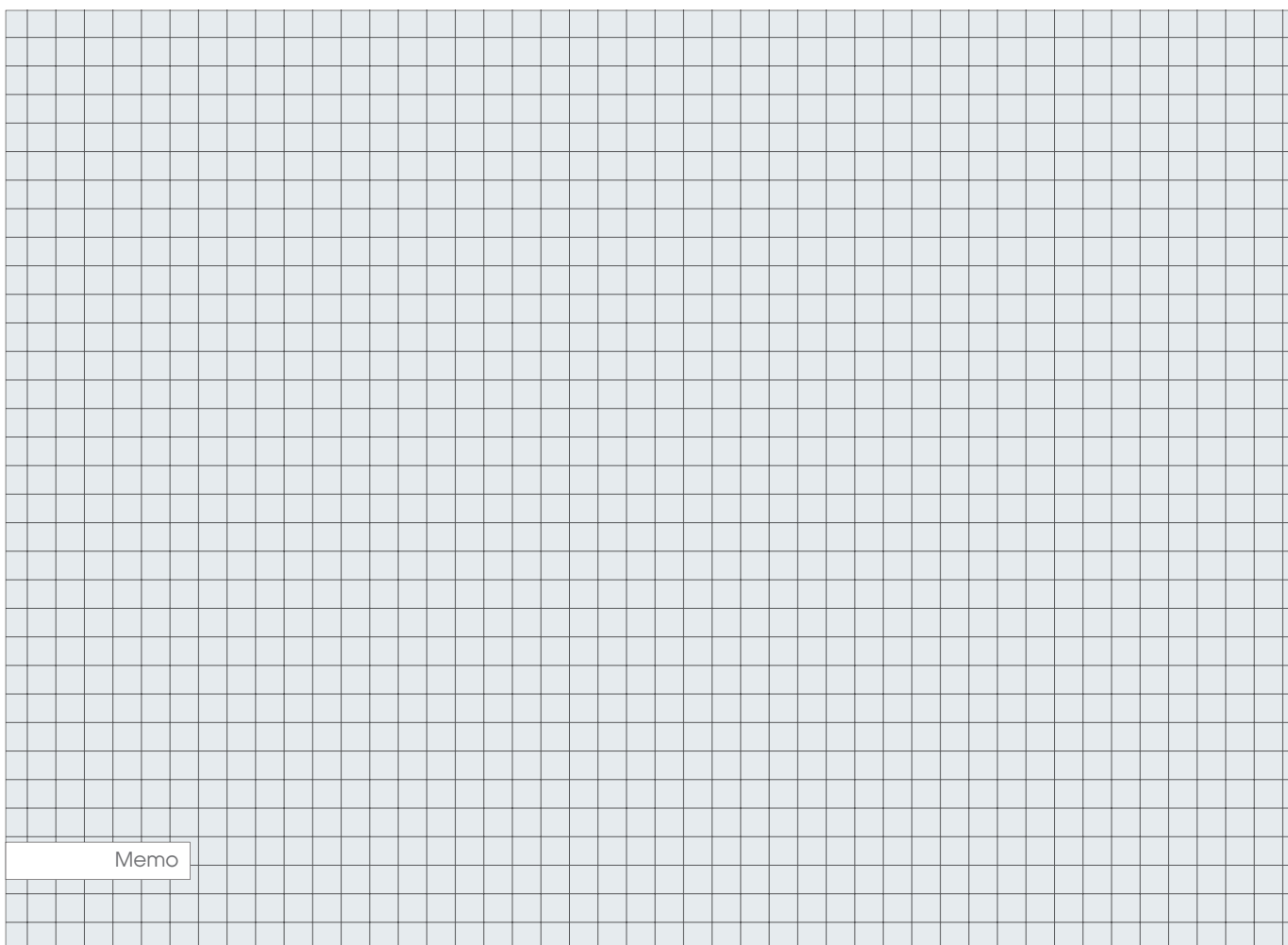

Memo

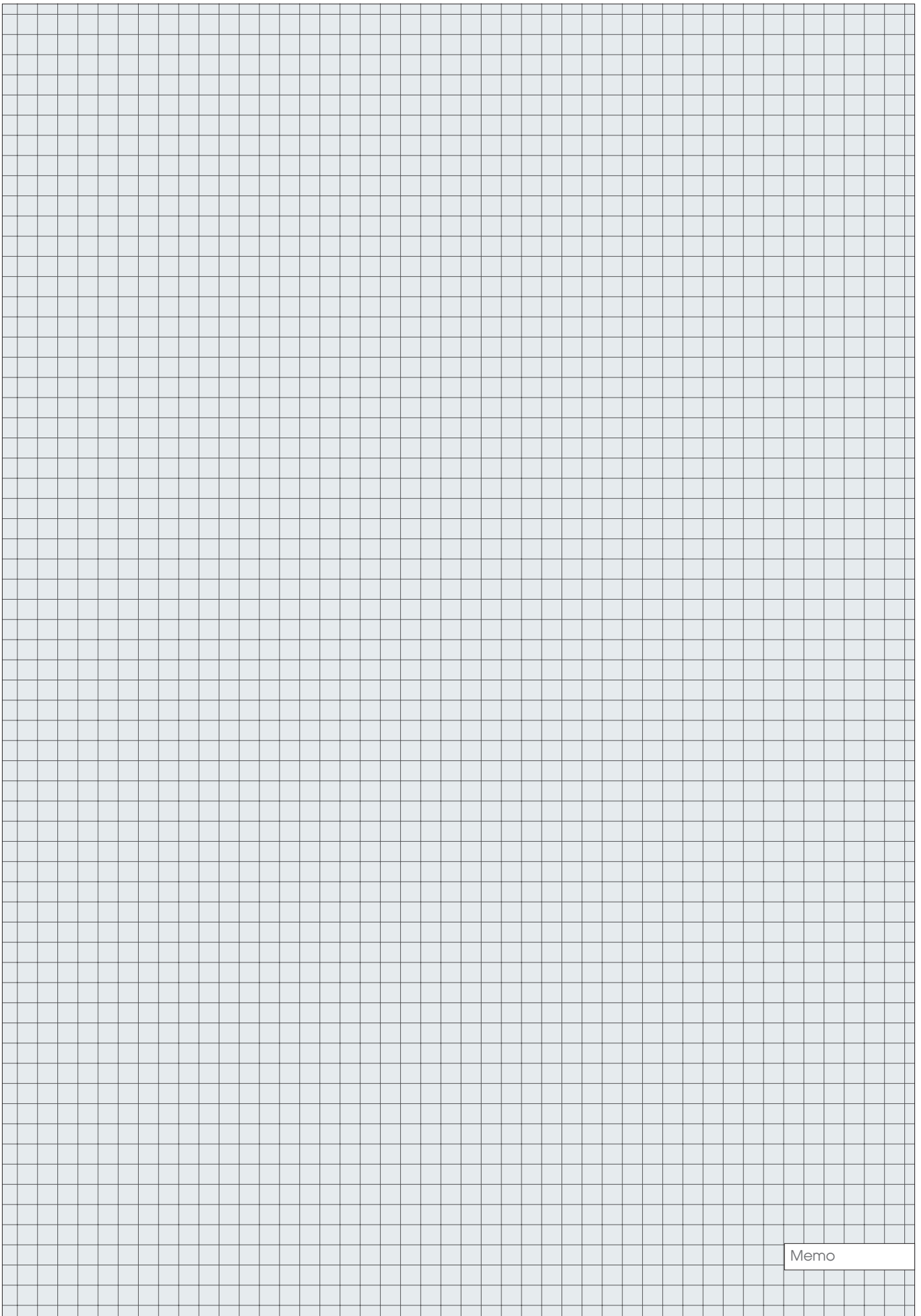

Memo

15

Power tools & accessories
Elektronarzędzia i akcesoria



Power tools STHOR
Elektronarzędzia STHOR

260-269

Impact drills	
Wiertarki udarowe.....	260
Rotary hammers	
Młoty udarowe.....	260
Demolition hammers	
Młoty wyburzeniowe.....	261
Cordless tools	
Urządzenia akumulatorowe.....	261
Impact wrenches	
Klucze udarowe.....	265
Angle grinders	
Szlifierki kątowe.....	265
Orbital sanders	
Szlifierki mimośrodowe.....	266
Finishing sanders	
Szlifierki oscylacyjne.....	266
Circular saws	
Pilarki tarczowe.....	266
Planers	
Strugi.....	266
Hot air guns	
Opalarki.....	266
Glue guns	
Pistolety do klejenia.....	267
Soldering guns	
Lutownice.....	267
Paint & mortar mixers	
Mieszarki do zapraw i farb.....	268
Pipe welders	
Zgrzewarki do rur.....	268
Water pumps	
Pompy wodne.....	269

Power tools LUND
Elektronarzędzia LUND

270-271

Knives for polystyrene foam	
Noże do styropianu.....	270
Angle grinders	
Szlifierki kątowe.....	270
Car polishers	
Polerki samochodowe.....	270
Hot air guns	
Opalarki.....	270
Glue guns	
Pistolety do klejenia.....	271
Soldering guns	
Lutownice.....	271
Pipe welders	
Zgrzewarki do rur.....	271

Power tools FLO
Elektronarzędzia FLO

.....272-275



Cordless tools	
Urządzenia akumulatorowe.....	272
Water pumps	
Pompy wodne.....	272
Grass trimmers	
Podkaszarki.....	274
Hedge shears	
Nożyce do żywopłotu.....	274
Chainsaws	
Piłarki łańcuchowe.....	274
Soil millers	
Glebogryzarki.....	274

Power tools
Elektronarzędzia

.....276



Soldering guns	
Lutownice.....	276

Accessories
Akcesoria

276-284



Grass trimmer lines	
Żyłki tnące do podkaszarek.....	276
Drill chucks	
Uchwyty wiertarskie.....	278
Adapters	
Adaptory.....	279
Drill bit sharpeners	
Ostrzałki do wiertel.....	279
Stands for power tools	
Statywy do elektronarzędzi.....	280
Spare blades, brushes, etc. for power tools	
Zapasowe ostrza, szczotki, końcówki do elektronarzędzi.....	280
Soldering iron accessories	
Akcesoria do lutownic.....	281
Gasoline water pump accessories	
Akcesoria do pomp spalinowych.....	284

EN Impact drill
 PL Wiertarka udarowa
 DE Schlagbohrmaschine
 RU Ударная дрель
 CS Nárazová vrtačka
 RO Masina de gaurit
 HU Kezelési utasítás
 ES Taladradora de percusión

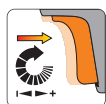

$L_{pA} = 90,0 \pm 3,0$ dB; $L_{wA} = 101,0 \pm 3,0$ dB; $a_n = 2,39 \pm 1,5 / 7,67 \pm 1,5$ m/s²

No.	Power / Moc [W]	Ω [min ⁻¹]	
78992	600	0-3000	10

EN Impact drill
 PL Wiertarka udarowa
 DE Schlagbohrmaschine
 RU Ударная дрель
 CS Nárazová vrtačka
 RO Masina de gaurit
 HU Kezelési utasítás
 ES Taladradora de percusión

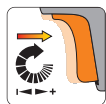

$L_{pA} = 98,06 \pm 3,0$ dB; $L_{wA} = 109,06 \pm 3,0$ dB; $a_n = 5,726 \pm 1,5 / 17,116 \pm 1,5$ m/s²

No.	Power / Moc [W]	Ω [min ⁻¹]	
78997	800	0-3000	10

EN Impact drill
 PL Wiertarka udarowa
 DE Schlagbohrmaschine
 RU Ударная дрель
 CS Nárazová vrtačka
 RO Masina de gaurit
 HU Kezelési utasítás
 ES Taladradora de percusión

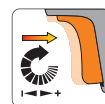

$L_{pA} = 98,06 \pm 3,0$ dB; $L_{wA} = 109,06 \pm 3,0$ dB; $a_n = 5,726 \pm 1,5 / 17,116 \pm 1,5$ m/s²

No.	Power / Moc [W]	Ω [min ⁻¹]	
78995	710	0-3000	10

EN Rotary hammer
 PL Młotowiertarka
 DE Bohrhämmer
 RU Перфоратор
 CS Vrtací kladivo
 RO Ciocan rotopercurtor
 HU Fűrőkalapács
 ES Martillo perforador

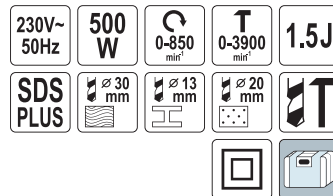

$L_{pA} = 87,0 \pm 3,0$ dB; $L_{wA} = 98,0 \pm 3,0$ dB; $a_n = 12,353 \pm 1,5 / 9,433 \pm 1,5$ m/s²

No.	Power / Moc [W]	Ω [min ⁻¹]	
79049	500	0-850	5

EN Rotary hammer
 PL Młotowiertarka
 DE Bohrhammer
 RU Перфоратор
 CS Vrtací kladivo
 RO Ciocan rotopercutor
 HU Fúrókalapács
 ES Martillo perforador



$L_{pa} = 92,0 \pm 3,0$ dB; $L_{wa} = 103,0 \pm 3,0$ dB; $a_n = 14,377 \pm 1,5 / 11,618 \pm 1,5$ m/s²

No.	Power / Moc [W]	Ω [min ⁻¹]	
79054	620	0-870	5

EN Rotary hammer
 PL Młotowiertarka
 DE Bohrhammer
 RU Перфоратор
 CS Vrtací kladivo
 RO Ciocan rotopercutor
 HU Fúrókalapács
 ES Martillo perforador

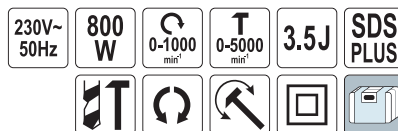

$L_{pa} = 89,4 \pm 3,0$ dB; $L_{wa} = 100,4 \pm 3,0$ dB; $a_n = 14,936 \pm 1,5 / 14,898 \pm 1,5$ m/s²

No.	Power / Moc [W]	Ω [min ⁻¹]	
79053	800	0-1000	4

EN Demolition hammer
 PL Młot wyburzeniowy
 DE Abbruchhammer
 RU Отбойный молоток
 CS Bourací kladivo
 RO Ciocan demolator
 HU Bontókalapács
 ES Martillo de demolición

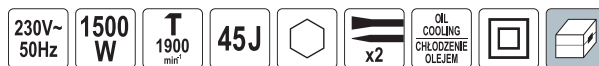

No.	Power / Moc [W]	Impact frequency / Częstotliwość uderu [min ⁻¹]	
79090	1500	1900	1

$L_{pa} = 92,9 \pm 3,0$ dB; $L_{wa} = 104,0 \pm 3,0$ dB; $a_n = 20,706 \pm 1,5$ m/s²

EN Cordless drill/driver
 PL Akumulatorowa wiertarko-wkrętarka
 DE Akku-Bohrschrauber
 RU Аккумуляторная дрель-шуруповерт
 CS Akumulátorový vrtací šroubovák
 RO Mașină de găurit și înșurubat cu acumulator
 HU Akkus fúró-csavarozó
 ES Taladro atornillador a batería

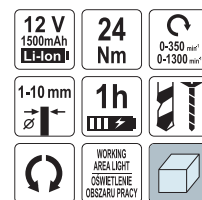

No.	Voltage / Napięcie [V d.c.]	Ω [min ⁻¹]	Toolholder size / Rozmiar uchwyty narzędziowego [mm]	
78101	12	0-350 / 0-1300	1-10	5

$L_{pa} = 70,72 \pm 3,0$ dB; $L_{wa} = 87,72 \pm 3,0$ dB; $a_n = 1,782 \pm 1,5$ m/s²

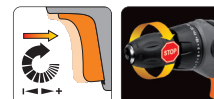

- EN Cordless drill/driver (tool only)
- PL Akumulatorowa wiertarko-wkrętarka (tylko narzędzie)
- DE Akkuschauber-und-Bohrer (nur das Gerät)
- RU Аккумуляторная дрель с шуруповертом (только инструмент)
- CS Akumulátorový vrtací šroubovák (pouze nářadí)
- RO Mașină de găurit și înșurubat cu acumulator (numai sculă)
- HU Akkus fúró-csavarozó (csak a szerszámot)
- ES Taladro atornillador a batería (herramienta solamente)

12V
Li-Ion

24 Nm

0-350 min⁻¹
0-1300 min⁻¹

1-10 mm

WORKING AREA LIGHT
OSWIETLENIE OBSZARU PRACY



Battery not included
Akumulatora nie dołączono

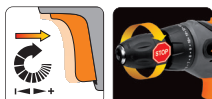

$L_{pa} = 70,72 \pm 3,0$ dB; $L_{wa} = 87,72 \pm 3,0$ dB; $a_n = 1,782 \pm 1,5$ m/s²

No.	Voltage / Napięcie [V d.c.]	∅ [min ⁻¹]	Toolholder size / Rozmiar uchwytu narzędziowego [mm]	
78102	12	0-350 / 0-1300	1-10	5

- EN Cordless impact screwdriver (tool only)
- PL Akumulatorowa zakrętarka udarowa (tylko narzędzie)
- DE Akku-Schlagschrauber (nur das Gerät)
- RU Аккумуляторный ударный винтовёрт (только инструмент)
- CS Akumulátorový rázový utahovák (pouze nářadí)
- RO Șurubelniță cu impact cu acumulator (numai sculă)
- HU Akkus ütvecsavarozó (csak a szerszámot)
- ES Atornillador de impacto a batería (herramienta solamente)

12V
Li-Ion

110 Nm

0-2300 min⁻¹

1/4"
6.3 mm

WORKING AREA LIGHT
OSWIETLENIE OBSZARU PRACY



Battery not included
Akumulatora nie dołączono



$L_{pa} = 70,76 \pm 3,0$ dB; $L_{wa} = 81,76 \pm 3,0$ dB; $a_n = 1,71 \pm 1,5$ m/s²

No.	Voltage / Napięcie [V d.c.]	∅ [min ⁻¹]	
78116	12	0-2300	5

- EN Cordless drill/driver (tool only)
- PL Akumulatorowa wiertarko-wkrętarka (tylko narzędzie)
- DE Akkuschauber-und-Bohrer (nur das Gerät)
- RU Аккумуляторная дрель с шуруповертом (только инструмент)
- CS Akumulátorový vrtací šroubovák (pouze nářadí)
- RO Mașină de găurit și înșurubat cu acumulator (numai sculă)
- HU Akkus fúró-csavarozó (csak a szerszámot)
- ES Taladro atornillador a batería (herramienta solamente)

12V
Li-Ion

24 Nm

0-350 min⁻¹
0-1300 min⁻¹

1-10 mm

1/4"
6.3 mm

WORKING AREA LIGHT
OSWIETLENIE OBSZARU PRACY



Battery not included
Akumulatora nie dołączono

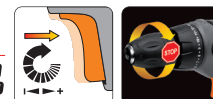

$L_{pa} = 70,72 \pm 3,0$ dB; $L_{wa} = 87,72 \pm 3,0$ dB; $a_n = 1,782 \pm 1,5$ m/s²

No.	Voltage / Napięcie [V d.c.]	∅ [min ⁻¹]	Toolholder size / Rozmiar uchwytu narzędziowego	
78106	12	0-350 / 0-1300	1-10 mm, 1/4" (6.3 mm)	5

- EN Cordless multi-purpose oscillating tool (tool only)
- PL Akumulatorowe wielofunkcyjne narzędzie oscylacyjne (tylko narzędzie)
- DE Akku-Multifunktionswerkzeug (nur das Gerät)
- RU Аккумуляторный многофункциональный инструмент (только инструмент)
- CS Akumulátorová multifunkční pila (pouze nářadí)
- RO Mașină multifuncțională cu acumulator (numai sculă)
- HU Akkus multifunkcionális vágószerszám (csak a szerszámot)
- ES Multiherramienta a batería (herramienta solamente)

12V
Li-Ion

5000-18000 min⁻¹



Battery not included
Akumulatora nie dołączono



$L_{pa} = 94,0 \pm 3,0$ dB; $L_{wa} = 105,0 \pm 3,0$ dB; $a_n = 11,24 \pm 1,5$ m/s²

No.	Voltage / Napięcie [V d.c.]	∅ [min ⁻¹]	
78124	12	5000-18000	10

EN Cordless drill/driver
 PL Akumulatorowa wiertarko-wkrętarka
 DE Akku-Bohrschrauber
 RU Аккумуляторная дрель-шуруповерт
 CS Akumulátorový vrtací šroubovák
 RO Mașină de găurit și înșurubat cu acumulator
 HU Akkus fúró-csavarozó
 ES Taladro atornillador a batería

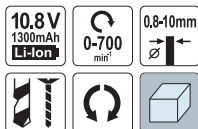

$L_{pa} = 89,0 \pm 3,0$ dB; $L_{wa} = 100,0 \pm 3,0$ dB; $a_n = 0,854 \pm 1,5 / 2,069 \pm 1,5$ m/s²

No.	Voltage / Napięcie [V d.c.]	∅ [min ⁻¹]	Toolholder size / Rozmiar uchwytu narzędziowego [mm]	5
78981	10.8	0-700	0.8-10	5

EN Cordless drill/driver
 PL Akumulatorowa wiertarko-wkrętarka
 DE Akku-Bohrschrauber
 RU Аккумуляторная дрель-шуруповерт
 CS Akumulátorový vrtací šroubovák
 RO Mașină de găurit și înșurubat cu acumulator
 HU Akkus fúró-csavarozó
 ES Taladro atornillador a batería

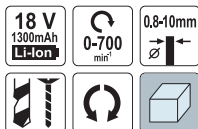

$L_{pa} = 89,0 \pm 3,0$ dB; $L_{wa} = 100,0 \pm 3,0$ dB; $a_n = 1,001 \pm 1,5 / 2,629 \pm 1,5$ m/s²

No.	Voltage / Napięcie [V d.c.]	∅ [min ⁻¹]	Toolholder size / Rozmiar uchwytu narzędziowego [mm]	5
78983	18	0-700	0.8-10	5

EN Cordless drill/driver
 PL Akumulatorowa wiertarko-wkrętarka
 DE Akku-Bohrschrauber
 RU Аккумуляторная дрель-шуруповерт
 CS Akumulátorový vrtací šroubovák
 RO Mașină de găurit și înșurubat cu acumulator
 HU Akkus fúró-csavarozó
 ES Taladro atornillador a batería



$L_{pa} = 87,0 \pm 3,0$ dB; $L_{wa} = 98,0 \pm 3,0$ dB; $a_n = 1,292 \pm 1,5 / 2,312 \pm 1,5$ m/s²

No.	Voltage / Napięcie [V d.c.]	∅ [min ⁻¹]	Toolholder size / Rozmiar uchwytu narzędziowego [mm]	5
78982	14.4	0-700	0.8-10	5

EN Battery
 PL Akumulator
 DE Akkumulator
 RU Аккумулятор
 CS Akumulátor
 RO Acumulatorul
 HU Akkumulátor
 ES Acumulador



No.	Voltage / Napięcie [V d.c.]	For / Dla	5
78985	10.8	78118, 78981	50
78986	14.4	78982	50
78987	18	78972, 78974, 78961, 78983	50

EN Battery charger
 PL Ładowarka
 DE Ladegerät
 RU Зарядное устройство

CS Nabíječka baterií
 RO Redresor
 HU Akkumulátortöltő
 ES Rectificador



STHOR

No.	Output voltage / Napięcie wyjściowe [V d.c.]	Output current / Prąd wyjściowy [mA]	For / Dla	
79087	15	400	79084	30
79088	18	400	79085	30
79089	24	400	79086	20

EN Cordless impact drill/driver
 PL Akumulatorowa wiertarko-wkrętarka udarowa
 DE Akku-Schlagbohrschrauber
 RU Аккумуляторный ударный дрель-шурупверт
 CS Akumulátorový nárazový šroubovák s příklepem
 RO Mașină de găurit și înșurubat cu acumulator
 HU Akkus ütvefűró-csavarozó
 ES Taladro atornillador con percusión a batería



$L_{pa} = 89,0 \pm 3,0$ dB; $L_{wa} = 100,0 \pm 3,0$ dB; $a_n = 15,25 \pm 1,5$ m/s²

STHOR

No.	Voltage / Napięcie [V d.c.]	Ω [min ⁻¹]	Toolholder size / Rozmiar uchwyty narzędziowego [mm]	
78974	18	0-350 / 0-1300	0.8-10	5

EN Cordless drill/driver
 PL Akumulatorowa wiertarko-wkrętarka
 DE Akku-Bohrschrauber
 RU Аккумуляторная дрель-шурупверт
 CS Akumulátorový vrtací šroubovák
 RO Mașină de găurit și înșurubat cu acumulator
 HU Akkus fűró-csavarozó
 ES Taladro atornillador a batería

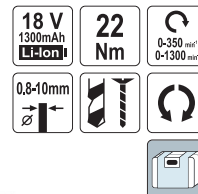

$L_{pa} = 89,0 \pm 3,0$ dB; $L_{wa} = 100,0 \pm 3,0$ dB; $a_n = 1,001 \pm 1,5 / 2,629 \pm 1,5$ m/s²

STHOR

No.	Voltage / Napięcie [V d.c.]	Ω [min ⁻¹]	Toolholder size / Rozmiar uchwyty narzędziowego [mm]	
78972	18	0-350 / 0-1300	0.8-10	5

EN Cordless glue gun
 PL Akumulatorowy pistolet do klejenia
 DE Heissklebepistole
 RU Пистолет для клея
 RO Pistol pt. lipit
 HU Ragasztópisztoly
 ES Pistola de cola



STHOR

No.	Voltage / Napięcie [V d.c.]	
78154	7.2	10

EN Electric impact wrench
 PL Elektryczny klucz udarowy
 DE Elektro-Schlagschrauber
 RU Электрический гайковерт
 CS Elektrický rázový uťahovák
 RO Pistol de impact electric
 HU Elektromos ütvecsavarozó
 ES llave de impacto eléctrica

230V~ 50Hz	800 W	2200 min ⁻¹	325 Nm	1/2" 12.7mm
17 mm	19 mm	21 mm	22 mm	



$L_{pA} = 87,5 \pm 3,0$ dB; $L_{wA} = 98,5 \pm 3,0$ dB; $a_n = 9,93 \pm 1,5$ m/s²

No.	Power / Moc [W]	ω [min ⁻¹]	
57091	800	2200	5

EN Electric impact wrench
 PL Elektryczny klucz udarowy
 DE Elektro-Schlagschrauber
 RU Электрический гайковерт
 CS Elektrický rázový uťahovák
 RO Pistol de impact electric
 HU Elektromos ütvecsavarozó
 ES llave de impacto eléctrica

230-240V~ 50Hz	1100 W	2200 min ⁻¹	800 Nm	3/4" 19mm
24 mm	30 mm	32 mm	36 mm	4m



$L_{pA} = 89,0 \pm 3,0$ dB; $L_{wA} = 100,0 \pm 3,0$ dB; $a_n = 10,04 \pm 1,5$ m/s²

No.	Power / Moc [W]	ω [min ⁻¹]	
57097	1100	2200	2

EN Electric impact wrench
 PL Elektryczny klucz udarowy
 DE Elektro-Schlagschrauber
 RU Электрический гайковерт
 CS Elektrický rázový uťahovák
 RO Pistol de impact electric
 HU Elektromos ütvecsavarozó
 ES llave de impacto eléctrica

230-240V~ 50Hz	1100 W	2200 min ⁻¹	450 Nm	1/2" 12.7mm
17 mm	19 mm	21 mm	22 mm	4m



$L_{pA} = 89,0 \pm 3,0$ dB; $L_{wA} = 100,0 \pm 3,0$ dB; $a_n = 10,04 \pm 1,5$ m/s²

No.	Power / Moc [W]	ω [min ⁻¹]	
57092	1100	2200	2

EN Angle grinder
 PL Szlifierka kątowna
 DE Winkelschleifmaschine
 RU Углошлифовальная машина
 CS Úhlová bruska
 RO Polizor unghiular
 HU Sarokcsiszoló
 ES Lijadera de angulo

230V~ 50Hz	1200 W	3000-11000 min ⁻¹	125 mm
M14			



$L_{pA} = 88,0 \pm 3,0$ dB; $L_{wA} = 99,0 \pm 3,0$ dB; $a_n = 6,5 \pm 1,5$ m/s²

No.	Power / Moc [W]	ω [min ⁻¹]	
79124	1200	3000-11000	10



EN Orbital sander
 PL Szlifierka mimośrodowa
 DE Exzentrische Schleifmaschine
 RU Эксцентриковая шлифовальная машина
 CS Excentrická bruska
 RO Polizor cu excentric
 HU Excenter csiszoló
 ES Pulidor excentrico

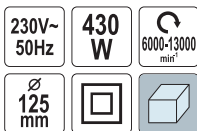

$L_{pa} = 81.0 \pm 3.0$ dB; $L_{wa} = 92.0 \pm 3.0$ dB; $a_n = 10.8 \pm 1.5$ m/s²

No.	Power / Moc [W]	ω [min ⁻¹]	
79309	430	6000-13000	6

EN Circular saw
 PL Pilarka ręczna
 DE Handkreissäge
 RU Дисковая пила
 CS Pila kotoučová
 RO Fierastrău circular
 HU Kézi körfűrészgép
 ES Sierra de disco

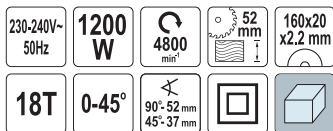

$L_{pa} = 94.0 \pm 3.0$ dB; $L_{wa} = 105.0 \pm 3.0$ dB; $a_n = 6.84 \pm 1.5$ m/s²

No.	Power / Moc [W]	ω [min ⁻¹]	
79254	1200	4800	4

EN Electric planer
 PL Strug elektryczny
 DE Elektrohobel
 RU Электрорубанок
 CS Elektrický hoblík
 RO Rindea electrică
 HU Elektromos gyalu
 ES Garfopa electrica



$L_{pa} = 83.0 \pm 3.0$ dB; $L_{wa} = 94.0 \pm 3.0$ dB; $a_n = 6.84 \pm 1.5$ m/s²

No.	Power / Moc [W]	ω [min ⁻¹]	
79416	600	16000	6

EN Finishing sander
 PL Szlifierka oscylacyjna
 DE Schwingschleifer
 RU Виброшлифмашина
 CS Oscilační bruska
 RO Polizor oscilant
 HU Vibrációs csiszológép
 ES Lijadora de oscilación

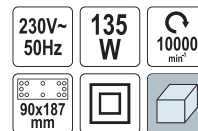

$L_{pa} = 84.0 \pm 3.0$ dB; $L_{wa} = 95.0 \pm 3.0$ dB; $a_n = 3.7 \pm 1.5$ m/s²

No.	Power / Moc [W]	ω [min ⁻¹]	
79491	135	10000	6

EN Circular saw
 PL Pilarka ręczna
 DE Handkreissäge
 RU Дисковая пила
 CS Pila kotoučová
 RO Fierastrău circular
 HU Kézi körfűrészgép
 ES Sierra de disco

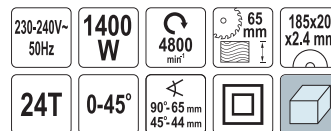

$L_{pa} = 94.0 \pm 3.0$ dB; $L_{wa} = 105.0 \pm 3.0$ dB; $a_n = 6.84 \pm 1.5$ m/s²

No.	Power / Moc [W]	ω [min ⁻¹]	
79257	1400	4800	4

EN Hot air gun
 PL Opalarka
 DE Heissluftpistole
 RU Строительный фен
 CS Orpálovací stroj
 RO Fion pt. ars vopsea
 HU Hőlégfúvó
 ES Secadora

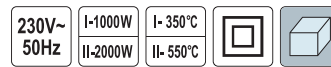

No.	Power / Moc [W]	Blast temperature / Temperatura nadmuchu [°C]	
79320	1000 (I) / 2000 (II)	350 (I) / 550 (II)	10

EN Hot air gun
 PL Opalarka
 DE Heissluftpistole
 RU Строительный фен
 CS Orpávací stroj
 RO Fion pt. ars vopsea
 HU Hőlégfúvó
 ES Secadora

230V~50Hz I-1000W II-1500W I-300°C II-500°C



No.	Power / Moc [W]	Blast temperature / Temperatura nadmuchu [°C]	
79327	1000 (I) / 1500 (II)	300 (I) / 500 (II)	10

EN Electric glue gun
 PL Pistolet do klejenia
 DE Heissklebepistole
 RU Пистолет для клея
 CS Pistole na lepení
 RO Pistol pt. lipit
 HU Ragasztópisztoly
 ES Pistola de cola

230V~50Hz 15(40)W 200°C 3-5 min
 8-12 g/min 2x Ø 11mm



No.	Power / Moc [W]	Glue stick diameter / Średnica wkładu klejowego [mm]	Capacity / Wydajność [g/min]	
73056	15 (40)	11	8-12	6/48

EN Electric glue gun
 PL Pistolet do klejenia
 DE Heissklebepistole
 RU Пистолет для клея
 CS Pistole na lepení
 RO Pistol pt. lipit
 HU Ragasztópisztoly
 ES Pistola de cola

230V~50Hz 23(80)W 200°C 3-5 min
 14-16 g/min 2x Ø 11mm



No.	Power / Moc [W]	Glue stick diameter / Średnica wkładu klejowego [mm]	Capacity / Wydajność [g/min]	
73057	23 (80)	11	14-16	6/48

EN Hot air gun with accessories
 PL Opalarka z akcesoriami
 DE Heissluftpistole
 RU Строительный фен в наборе
 CS Orpávací stroj s příslušenstvím
 RO Fion cu accesorii pt. ars vopsea
 HU Hőlégfúvó tartozékokkal
 ES Secadora con accesorios

230V~50Hz I-1000W II-1500W I-300°C II-500°C



No.	Power / Moc [W]	Blast temperature / Temperatura nadmuchu [°C]	
79328	1000 (I) / 1500 (II)	300 (I) / 500 (II)	5

EN Electric glue gun
 PL Pistolet do klejenia
 DE Heissklebepistole
 RU Пистолет для клея
 CS Pistole na lepení
 RO Pistol pt. lipit
 HU Ragasztópisztoly
 ES Pistola de cola

230V~50Hz 15(100)W 180-200°C 3-6 min
 15 g/min 2x Ø 11mm



No.	Power / Moc [W]	Glue stick diameter / Średnica wkładu klejowego [mm]	Capacity / Wydajność [g/min]	
73052	15 (100)	11	15	12/48

EN Soldering iron
 PL Lutownica oporogová
 DE Delötkolben
 RU Электропаяльник
 CS Pájka odporová
 RO Ciocan de lipit
 HU Huforrasztópáka
 ES Soldador de resistencia

230V~50Hz 400°C 5-10 min



No.	Power / Moc [W]	
79365	30	25/50
79366	40	25/50
79367	60	25/50
79368	80	25/50

EN Soldering iron
 PL Lutownica oporowa
 DE Lötkolben
 RU Электропаяльник
 CS Pájka odporová
 RO Ciocan de lipit
 HU Huforrasztópáka
 ES Soldador de resistencia

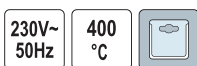

STHOR

No.	Power / Moc [W]	
79393	30	25/50
79396	80	25/50

EN Transformer soldering gun
 PL Lutownica transformatorowa
 DE Lötpistole
 RU Электрический паяльник
 CS Transformátorová páječka
 RO Pistol de lipit
 HU Forrasztópáka
 ES Soldador transformador



STHOR

No.	Power / Moc [W]	
79354	100	10

EN PVC plastic pipe welder
 PL Zgrzewarka do rur termoplastycznych
 DE Schweissgerät für thermoplastische Rohre
 RU Аппарат для сварки пластиковых труб
 CS Svářečka na termoplastické trubky
 RO Masina de sudat tevi termoplastice
 HU Hegesztő berendezés termoplasztikus csövekhez
 ES Máquina de soldar las tubos termoplásticos

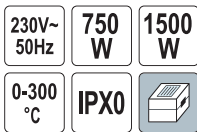

STHOR

No.	Power / Moc [W]	
78912	750, 1500	4

EN Spare soldering tips
 PL Komplet grotów do stacji lutowniczej
 DE Lötspitze
 RU Наконечник паяльника
 CS Hrot do letovačky
 RO Vârf pt. ciocanul de lipit
 HU Pákahegy
 ES Pico soldador

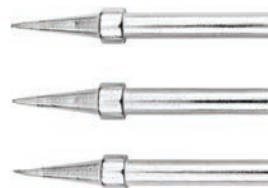

STHOR

No.	Power / Moc [W]	Peak diameter / Średnica wierzchołka	For / Dla	pcs / szt.	
79377	40	0.4, 0.8, 1.2	79376	3	600
79378	40	1.6, 1.6, 3.2	79376	3	600

EN Electric paddle mixer
 PL Mieszarka do zapraw
 DE Mörtelmischgerät
 RU Электрическая мешалка для минометов
 CS Míchadlo na maltu
 RO Malaxor pt. mortar
 HU Habarcskeverő
 ES Mezcladora de mortero



STHOR

No.	Power / Moc [W]	ω [min ⁻¹]	
78855	850	0-900	4

$L_{pa} = 87,0 \pm 3,0$ dB; $L_{wa} = 98,0 \pm 3,0$ dB; $a_h = 5,45 \pm 1,5$ m/s²

EN PVC plastic pipe welder
 PL Zgrzewarka do rur termoplastycznych
 DE Schweissgerät für thermoplastische Rohre
 RU Аппарат для сварки пластиковых труб
 CS Svářečka na termoplastické trubky
 RO Masina de sudat tevi termoplastice
 HU Hegesztő berendezés termoplasztikus csövekhez
 ES Máquina de soldar las tubos termoplásticos

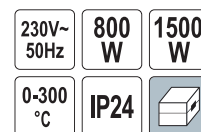

STHOR

No.	Power / Moc [W]	
78910	800, 1500	5

EN Dirty water submersible pump
 PL Pompa zatapialna do wody brudnej
 DE Tauchpumpe für Schmutzwasser
 RU Погружной насос для грязной воды
 CS Ponorné čerpadlo pro špinavú vodu
 RO Pompă submersibilă pt. apă murdară
 HU Búvárszivattyú
 ES Bomba sumergible para agua sucia

230V~ 50Hz	400 W	Q max 6000 l/h	△ 6.0m
1" 25mm	5/4" 32mm	1.5" 38mm	



STHOR

No.	Power / Moc [W]	Max. capacity / Maks. wydajność [l/h]	Max. head / Maks. wysokość tłoczenia [m]	
79909	400	6000	6	6

EN Membrane deep well water pump
 PL Pompa membranowa zatapialna
 DE Tauchmotorpumpe
 RU Погружной насос
 CS Zataovací čerpadlo
 RO Pompă pt. apă cu membrană
 HU Búvárszivattyú
 ES Bomba de diafragma sumergible

EN Dirty water submersible pump
 PL Pompa zatapialna do wody brudnej
 DE Tauchmotorpumpe
 RU Погружной насос
 CS Zataovací čerpadlo
 RO Pompă pt. apă murdară
 HU Búvárszivattyú
 ES Bomba de inmersión para agua sucia

230V~ 50Hz	1" 25mm
5/4" 32mm	1.5" 38mm



STHOR

No.	Power / Moc [W]	Max. capacity / Maks. wydajność [l/h]	Max. head / Maks. wysokość tłoczenia [m]	
79781	400	8000	5.5	4
79782	500	10000	6.5	4
79783	600	11500	7.0	4

STHOR

No.	Power / Moc [W]	Max. capacity / Maks. wydajność [l/h]	Max. head / Maks. wysokość tłoczenia [m]	
79943	280	1020	68	4

230V~ 50Hz	280 W
Q max 1020 l/h	△ 68m



Memo	
------	--

EN Thermal knife for polystyrene foam
 PL Nóż termiczny do styropianu
 DE Thermomesser für Styropor
 RU Термонож для пенопласта
 CS Termický nůž na pěnový polystyrén
 RO Cuțit termic pt. stiropian
 HU Polisztirol vágó hőkés
 ES Cuchilla térmica para poliestireno



INCLUDED:
 - 3 interchangeable tips: wire 17 cm, hot knife 12 cm, engraving tool 3.5 cm
 - Base
 - Additional cutting wire (1 pcs)

W ZESTAWIE:
 - 3 wymienne końcówki: drut 17 cm, nóż do cięcia na gorąco 12 cm, nasadka do grawerowania 3.5 cm
 - Podstawka
 - Zapasowy drut tnący (1 szt.)



LUND

No.	Power / Moc [W]	Box
78894	9	20

EN Angle grinder
 PL Szlifierka kątowa
 DE Winkelschleifmaschine
 RU Углошлифовальная машина
 CS Úhlová bruska
 RO Polizor unghiular
 HU Sarokcsiszoló
 ES Lijadera de angulo



LUND

$L_{pa} = 88,0 \pm 3,0$ dB; $L_{wa} = 99,0 \pm 3,0$ dB; $a_n = 6,92 \pm 1,5$ m/s²

No.	Power / Moc [W]	ω [min ⁻¹]	Box
79125	500	11500	10

EN Hot air gun
 PL Opalarka
 DE Heissluftpistole
 RU Строительный фен
 CS Opaľovací stroj
 RO Fion pt. ars vopseaua
 HU Hőlégfúvó
 ES Secadora



LUND

No.	Power / Moc [W]	Blast temperature / Temperatura nadmuchu [°C]	Box
79324	750 (I) / 1500 (II)	300 (I) / 500 (II)	10

EN Mini grinder
 PL Uniwersalna szlifierka wielofunkcyjna
 DE Universal-Mehrweckschleifmaschine
 RU Универсальная шлифовальная машина
 CS Všeúčelová univerzální bruska
 RO Mașina de șlefuit universală multifuncțională
 HU Univerzális daugjafunkcis šlifvoklis
 ES Lijadora multifunción

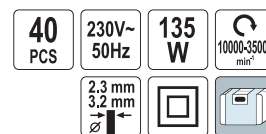

LUND

$L_{pa} = 72,0 \pm 3,0$ dB; $L_{wa} = 83,0 \pm 3,0$ dB; $a_n = 2,6 \pm 1,5$ m/s²

No.	Power / Moc [W]	ω [min ⁻¹]	Box
79314	135	10 000 (I) / 15 000 (II) / 20 000 (III) / 25 000 (IV) / 30 000 (V) / 33 000 (VI) / 35 000 (max)	10

EN Car polisher
 PL Polerka samochodowa
 DE Autopoliermaschine
 RU Полировальная машинка
 CS Leštička na automobily
 RO Masina de lustruit automobile
 HU Gépkocsi polírozógép
 ES Maquina para pulir coches

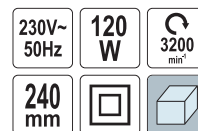

LUND

$L_{pa} = 55,0 \pm 3,0$ dB; $L_{wa} = 66,0 \pm 3,0$ dB; $a_n = 14,8 \pm 1,5$ m/s²

No.	Power / Moc [W]	ω [min ⁻¹]	Box
82942	120	3200	6

EN Hot air gun with accessories
 PL Opalarka z akcesoriami
 DE Heissluftpistole
 RU Строительный фен в наборе
 CS Opaľovací stroj s príslušenstvom
 RO Fion cu accesorii pt. ars vopseaua
 HU Hőlégfúvó tartozékokkal
 ES Secadora con accesorios

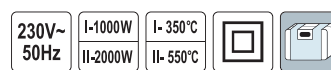

LUND

No.	Power / Moc [W]	Blast temperature / Temperatura nadmuchu [°C]	Box
79325	1000 (I) / 2000 (II)	350 (I) / 550 (II)	10

EN Electric glue gun
 PL Pistolet do klejenia
 DE Heissklebepistole
 RU Пистолет для клея
 CS Pistole na lepení
 RO Pistol pt. lipit
 HU Ragasztópisztoly
 ES Pistola de cola

110-240V~50Hz 12(72) W 190-210 °C 3-5 min
 7 g/min 2x ∅ 11mm



LUND

No.	Power / Moc [W]	Glue stick diameter / Średnica wkładu klejowego [mm]	Capacity / Wydajność [g/min]	Box
73051	12 (72)	11	7	12/48

EN Soldering iron
 PL Lutownica oporowa
 DE Lötkolben
 RU Электродпаяльник
 CS Pájka odporová
 RO Ciocan de lipit
 HU Huforrasztópáka
 ES Soldador de resistencia

230V~50Hz 400 °C 5-10 min



LUND

No.	Power / Moc [W]	Soldering tip dimensions / Wymiary grotu [mm]	Box
79382	40	Ø5x70	25/50
79383	60	Ø6x78	25/50

EN Transformer soldering gun
 PL Lutownica transformatorowa
 DE Lötpistole
 RU Электрический паяльник
 CS Transformátorová páječka
 RO Pistol de lipit
 HU Forrasztópáka
 ES Soldador transformador

230V~50Hz 100 W WORKING AREAS LIST: CS: KABELNÍ PRÁCE



LUND

No.	Power / Moc [W]	Box
79355	100	10

EN PVC plastic pipe welder
 PL Zgrzewarka do rur termoplastycznych
 DE Schweissgerät für thermoplastische Rohre
 RU Аппарат для сварки пластиковых труб
 CS Svářečka na termoplastické trubky
 RO Masina de sudat tevi termoplastice
 HU Hegesztő berendezés termoplasztikus csövekhez
 ES Máquina de soldar las tubos termoplásticos



LUND

No.	Power / Moc [W]	Box
78911	800	5

EN Electric glue gun
 PL Pistolet do klejenia
 DE Heissklebepistole
 RU Пистолет для клея
 CS Pistole na lepení
 RO Pistol pt. lipit
 HU Ragasztópisztoly
 ES Pistola de cola

230V~50Hz 16 W 200 °C 11 g/min
 3-5 min 11 mm



LUND

No.	Power / Moc [W]	Glue stick diameter / Średnica wkładu klejowego [mm]	Capacity / Wydajność [g/min]	Box
73060	16	11	11	10

EN Soldering iron
 PL Lutownica oporowa
 DE Lötkolben
 RU Электродпаяльник
 CS Pájka odporová
 RO Ciocan de lipit
 HU Forrasztópáka
 ES Soldador de resistencia

230V~50Hz 100 W 400 °C 5-10 min 8.0 mm



LUND

No.	Power / Moc [W]	Soldering tip dimensions / Wymiary grotu [mm]	Box
79385	100	Ø8x64	25/50

EN Wood burning kit
 PL Lutownica i pirograf do drewna
 DE Holzofen Kit
 RU Пирографии набор
 CS Souprava pro spalování dřeva
 RO Set pirogravură
 HU Pirográf készlet
 ES Pirograbado de madera kit

230V~50Hz 30 W 400 °C



LUND

No.	Power / Moc [W]	Box
78890	30	15

230V~50Hz 800 W 0-300 °C IPX4



- EN Cordless grass and shrub shears
- PL Akumulatorowe nożyce do trawy i krzewów
- DE Akkuscherer mit Gras- und Strauchmesser
- RU Аккумуляторные ножницы для травы и кустов
- CS Akumulátorové nůžky na trávu a keře
- RO Trimmer cu acumulator pt. iarba si gard viu
- HU Foaarfecele cu acumulator pt. táiat iarba
- ES Tijeras a batería para hierba y arbustos

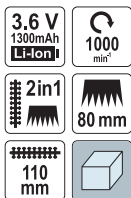

$L_{pA} = 74,6 \pm 3,0$ dB; $L_{wA} = 86,4 \pm 3,0$ dB; $a_p = 1,63 \pm 1,5$ m/s²

No.	ω [min ⁻¹]	
79500	1000	8

- EN Battery sprayer
- PL Opryskiwacz akumulatorowy
- DE Akku-Sprüngerät
- RU Аккумуляторный опрыскиватель
- CS Bateriový postřikovač
- RO Vermorel cu acumulator
- HU Akkumulátoros permetező
- ES Pulverizador a batería



No.	Voltage / Napięcie [V d.c.]	Tank capacity / Pojemność zbiornika [l]	
89610	12	16	1

- EN Dirty water submersible pump
- PL Pompa zatapialna do wody brudnej
- DE Tauchmotorpumpe
- RU Погружной насос
- CS Zatavovací čerpadlo
- RO Pompă pt. apă murdară
- HU Búvárszivattyú
- ES Bomba de inmersión para agua sucia

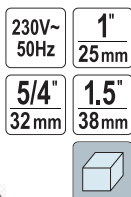

No.	Power / Moc [W]	Max. capacity / Maks. wydajność [l/h]	Max. head / Maks. wysokość tłoczenia [m]	
79771	400	10000	6.5	4
79772	550	11500	7.0	4
79773	750	14000	7.5	4
79774	900	16000	8.5	4
79775	1100	16000	8.5	4

- EN Cordless grass and shrub shears
- PL Akumulatorowe nożyce do trawy i krzewów
- DE Akkuscherer mit Gras- und Strauchmesser
- RU Аккумуляторные ножницы для травы и кустов
- CS Akumulátorové nůžky na trávu a keře
- RO Trimmer cu acumulator pt. iarba si gard viu
- HU Foaarfecele cu acumulator pt. táiat iarba
- ES Tijeras a batería para hierba y arbustos

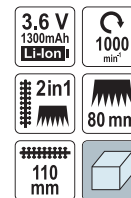

$L_{pA} = 74,6 \pm 3,0$ dB; $L_{wA} = 86,4 \pm 3,0$ dB; $a_p = 1,63 \pm 1,5$ m/s²

No.	ω [min ⁻¹]	
79501	1000	8

- EN Battery sprayer
- PL Opryskiwacz akumulatorowy
- DE Akku-Sprüngerät
- RU Аккумуляторный опрыскиватель
- CS Bateriový postřikovač
- RO Vermorel cu acumulator
- HU Akkumulátoros permetező
- ES Pulverizador a batería



No.	Voltage / Napięcie [V d.c.]	Tank capacity / Pojemność zbiornika [l]	
89611	12	16	1

- EN Dirty water submersible pump
- PL Pompa zatapialna do wody brudnej
- DE Tauchmotorpumpe
- RU Погружной насос
- CS Zatavovací čerpadlo
- RO Pompă pt. apă murdară
- HU Búvárszivattyú
- ES Bomba de inmersión para agua sucia

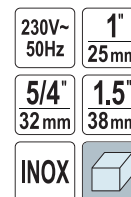

No.	Power / Moc [W]	Max. capacity / Maks. wydajność [l/h]	Max. head / Maks. wysokość tłoczenia [m]	
79790	750	14000	7.5	2
79791	900	16000	8.5	2
79792	1100	20000	9.0	2

EN Membrane deep well water pump
 PL Pompa membranowa zatapialna
 DE Tauchmotorpumpe
 RU Погружной насос
 CS Zatavovací čerpadlo
 RO Pompa pt. apă cu membrană
 HU Búvárszivattyú
 ES Bomba de diafragma sumergible



220-230V~
50Hz

350 W

Q max
1200 l/h

70m



No.	Power / Moc [W]	Max. capacity / Maks. wydajność [l/h]	Max. head / Maks. wysokość tłoczenia [m]	
79944	350	1200	70	4

EN Submersible pump for dirty water and wastewater
 PL Pompa zatapialna do wody brudnej i ścieków
 DE Tauchpumpe für Schmutzwasser
 RU Погружной насос для грязной воды
 CS Ponorné čerpadlo pro odpadní vody
 RO Pompă submersibilă pt. apă uzată
 HU Búvárszivattyú szennyvíz
 ES Bomba sumergible para aguas residuales

230V~
50Hz

450 W

Q max
16000 l/h



No.	Power / Moc [W]	Max. capacity / Maks. wydajność [l/h]	Max. head / Maks. wysokość tłoczenia [m]	
79880	450	16000	9	1

EN Fountain pump
 PL Pompa fontannaowa
 DE Springbrunnenpumpe
 RU Фонтанный насос
 CS Fontánová pumpa
 RO Pompa pt. fantana arteziana
 HU Pumpa szökőkúthoz
 ES Bomba para las fuentes



230V~
50Hz

3
NOZZLES
DYSZE

IPX8



No.	Power / Moc [W]	Max. capacity / Maks. wydajność [l/h]	Max. head / Maks. wysokość tłoczenia [m]	
79926	8	600	1.0	12
79927	16	800	1.3	12
79928	22	1000	1.6	12

EN Submersible pump for dirty water and wastewater
 PL Pompa zatapialna do wody brudnej i ścieków
 DE Tauchpumpe für Schmutzwasser
 RU Погружной насос для грязной воды
 CS Ponorné čerpadlo pro odpadní vody
 RO Pompă submersibilă pt. apă uzată
 HU Búvárszivattyú szennyvíz
 ES Bomba sumergible para aguas residuales



230V~
50Hz

450 W

Q max
9000 l/h



No.	Power / Moc [W]	Max. capacity / Maks. wydajność [l/h]	Max. head / Maks. wysokość tłoczenia [m]	
79881	450	9000	10	1

EN Jet pump
 PL Pompa ogrodowa
 DE Gartenpumpe
 RU Насос садовый

CS Zahradní čerpadlo
 RO Pompa apă
 HU Kerti szivattyúhoz
 ES Bomba de jardín con cabeza

230V~
50Hz



L_{WA} = 95,0 ± 3,0 dB

No.	Power / Moc [W]	Max. capacity / Maks. wydajność [l/h]	Max. lifting height / Maks. wysokość podnoszenia [m]	Max. pumping pressure / Maks. ciśnienie tłoczenia [bar]	
79810	600	2800	35	3.5	1
79811	800	3600	40	4.0	1
79812	1000	3800	44	4.4	1

15

EN Fountain pump
 PL Pompa fontannaowa
 DE Springbrunnenpumpe
 RU Фонтанный насос
 CS Fontánová pumpa
 RO Pompa pt. fantana arteziana
 HU Pumpa szökőkúthoz
 ES Bomba para las fuentes



230V~
50Hz

5
NOZZLES
DYSZE

IPX8



No.	Power / Moc [W]	Max. capacity / Maks. wydajność [l/h]	Max. head / Maks. wysokość tłoczenia [m]	
79929	28	1400	2.0	8
79930	40	1800	2.5	8

- EN Fountain pump
- PL Pompa fontannaowa
- DE Springbrunnenpumpe
- RU Фонтанный насос
- CS Fontánová pumpa
- RO Pompa pt. fantana arteziana
- HU Pumpa szökőkúthoz
- ES Bomba para las fuentes



230V~
50Hz

5
NOZZLES
DYSZE

IP68

10 m



No.	Power / Moc [W]	Max. capacity / Maks. wydajność [l/h]	Max. head / Maks. wysokość tłoczenia [m]	
79931	55	2000	2.5	8
79932	85	3000	3.5	8
79933	100	4500	4.5	6

- EN Hedge shears
- PL Elektryczne nożyce do żywoplotu
- DE Heckenscheren
- RU Ножницы для живой изгороди
- CS Nůžky na živý plot
- RO Foarfece pt. gard viu
- HU Sövényvágó olló
- ES Tijera para vallado

230V~
50Hz

450
W

1700
min⁻¹

410
mm



$L_{pA} = 81,6 \pm 3,0$ dB; $L_{wA} = 101,6 \pm 3,0$ dB; $a_n = 5,328 \pm 1,5 / 6,1214 \pm 1,5$ m/s²

No.	Power / Moc [W]	Cutting speed / Predkość cięcia [min ⁻¹]	Cutting length / Długość cięcia [mm]	
79442	450	1700	410	4

- EN Electrical chainsaw
- PL Elektryczna pilarka łańcuchowa
- DE Elektrische Kettensäge
- RU Цепная электропила
- CS Elektrická řetězová pila
- RO Ferăstrau electric cu lanț
- HU Elektromos láncfűrész
- ES Sierra de cadena eléctrica

230-240V~
50Hz

1600
W

7000
min⁻¹

14"
35.5 cm

13 m/s

1.1 l



$L_{pA} = 90,2 \pm 3,0$ dB; $L_{wA} = 103,2 \pm 3,0$ dB; $a_n = 8,393 \pm 1,5 / 6,002 \pm 1,5$ m/s²

No.	Power / Moc [W]	
79675	1600	2

- EN Electric trimmer
- PL Podkaszarka elektryczna
- DE Elektro-Rasentrimmer
- RU Электрический триммер
- CS Elektrická sekačka
- RO Cositoare electrică
- HU Elektromos fűnyíró
- ES Segadora eléctrica



230V~
50Hz

500
W

10500
min⁻¹

280
mm

80-100
cm

2
POSITIONS
POZICIE



$L_{pA} = 74,4 \pm 1,94$ dB; $L_{wA} = 94,1 \pm 1,94$ dB; $a_n = 0,794 \pm 1,5$ m/s²

No.	Power / Moc [W]	Ω [min ⁻¹]	Cutting width / Szerokość cięcia [mm]	
79467	500	10500	280	4

- EN Hedge shears
- PL Elektryczne nożyce do żywoplotu
- DE Heckenscheren
- RU Ножницы для живой изгороди
- CS Nůžky na živý plot
- RO Foarfece pt. gard viu
- HU Sövényvágó olló
- ES Tijera para vallado

230V~
50Hz

550
W

1700
min⁻¹

510
mm



$L_{pA} = 78,58 \pm 1,489$ dB; $L_{wA} = 98,54 \pm 1,489$ dB; $a_n = 3,272 \pm 1,5 / 3,435 \pm 1,5$ m/s²

No.	Power / Moc [W]	Cutting speed / Predkość cięcia [min ⁻¹]	Cutting length / Długość cięcia [mm]	
79448	550	1700	510	4

- EN Electric soil miller
- PL Glebogryzarka elektryczna
- DE Elektro-Bodenhacke
- RU Электрический культиватор
- CS Elektrický kultivátor
- RO Motosapa electrica
- HU Elektromos kapálógép
- ES Cultivador rotativo eléctrico



230-240V~
50Hz

750
W

220
mm

320
mm

205
mm



$L_{pA} = 79,0 \pm 3,0$ dB; $L_{wA} = 91,87 \pm 0,48$ dB; $a_n = 1,153 \pm 1,5 / 1,158 \pm 1,5$ m/s²

No.	Power / Moc [W]	
79725	750	1

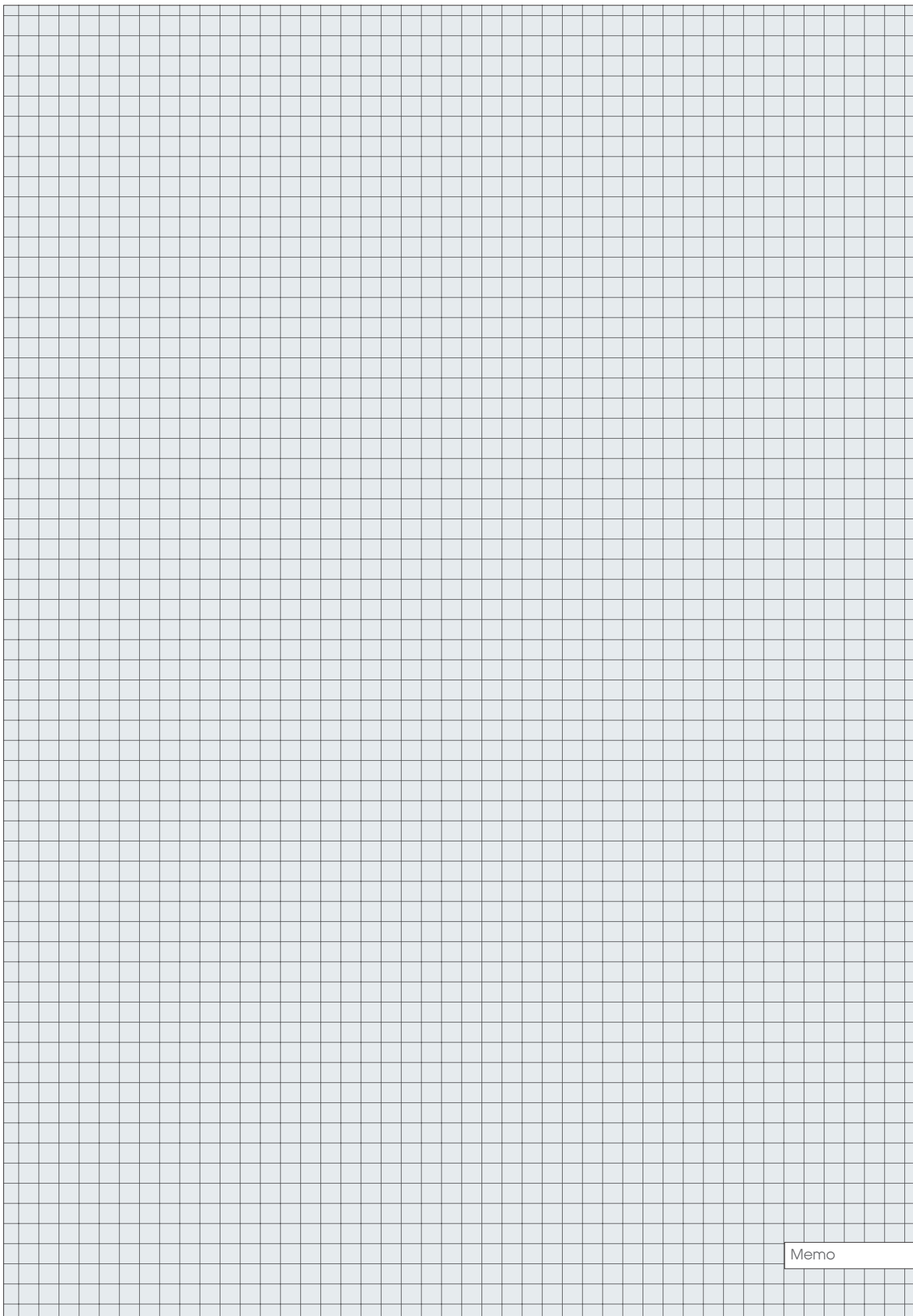

Memo

EN Soldering iron
 PL Lutownica pistoletowa
 DE DelötKolben
 RU Электропаяльник

CS Pájka odporová
 RO Ciocan de lipit
 HU Huforrasztópáka
 ES Soldador de resistencia



No.	Power / Moc [W]	
79358	40	25/50

EN Line head
 PL Głowica żyłkowa
 DE Trimmerkopf
 RU Головка с леской
 CS Strunová hlava
 RO Cap cu cablu
 HU Damil fej
 ES Cabezal de hilo



No.	Ø [mm]	
79550	2.0-2.4	10/40

EN Line head
 PL Głowica żyłkowa
 DE Trimmerkopf
 RU Головка с леской
 CS Strunová hlava
 RO Cap cu cablu
 HU Damil fej
 ES Cabezal de hilo



No.	Ø [mm]	
79552	2.4-2.7	10/40

EN Grass trimmer line
 PL Żyłka tnąca
 DE Mähfaden
 RU Леска для триммера

CS Struna do strunové sekačky
 RO Furtun gradina
 HU Damil szegélynyíró géphez
 ES Hilo de cortar



No.	Ø [mm]	L [m]	Cutting line profile / Przekrój żyłki	
89401	1.3	10	○	20/240
89402	1.6	10	○	20/240
89403	2.0	10	○	20/240
89404	2.4	10	○	12/144
89405	2.6	10	○	12/144
89406	3.0	10	○	12/144

EN Transformer soldering gun
 PL Lutownica transformatorowa
 DE Lötpestole
 RU Электрический паяльник

CS Transformátorová páječka
 RO Pistol de lipit
 HU Forrasztópáka
 ES Soldador transformador

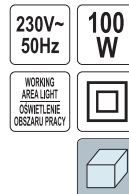

No.	Power / Moc [W]	
79350	100	24

EN Line head
 PL Głowica żyłkowa
 DE Trimmerkopf
 RU Головка с леской
 CS Strunová hlava
 RO Cap cu cablu
 HU Damil fej
 ES Cabezal de hilo

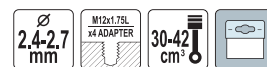

No.	Ø [mm]	
79551	2.4-2.7	10/40

EN Line head
 PL Głowica żyłkowa
 DE Trimmerkopf
 RU Головка с леской
 CS Strunová hlava
 RO Cap cu cablu
 HU Damil fej
 ES Cabezal de hilo



No.	Ø [mm]	For / Dla	
79468	1.2	79467	20/100



EN Grass trimmer line
 PL Żyłka tnąca
 DE Mähfaden
 RU Леска для триммера
 CS Struna do strunové sekačky
 RO Furtun gradina
 HU Damil szegélynyíró géphez
 ES Hilo de cortar



FLO

No.	Ø [mm]	L [m]	Cutting line profile / Przekrój żyłki	
89441	2.0	120	○	27
89442	2.4	90	○	27
89443	2.6	70	○	27
89444	3.0	56	○	27

EN Grass trimmer line
 PL Żyłka tnąca
 DE Mähfaden
 RU Леска для триммера
 CS Struna do strunové sekačky
 RO Furtun gradina
 HU Damil szegélynyíró géphez
 ES Hilo de cortar



FLO

No.	Ø [mm]	L [m]	Cutting line profile / Przekrój żyłki	
89452	2.4	90	□	16
89453	2.6	70	□	16
89454	3.0	56	□	16

EN Grass trimmer line
 PL Żyłka tnąca
 DE Mähfaden
 RU Леска для триммера
 CS Struna do strunové sekačky
 RO Furtun gradina
 HU Damil szegélynyíró géphez
 ES Hilo de cortar



FLO

No.	Ø [mm]	L [m]	Cutting line profile / Przekrój żyłki	
89456	2.0	90	☆	9/27
89457	2.4	90	☆	9/27
89458	2.6	90	☆	9/27
89459	3.0	60	☆	9/27

EN Grass trimmer line
 PL Żyłka tnąca
 DE Mähfaden
 RU Леска для триммера
 CS Struna do strunové sekačky
 RO Furtun gradina
 HU Damil szegélynyíró géphez
 ES Hilo de cortar



FLO

No.	Ø [mm]	L [m]	Cutting line profile / Przekrój żyłki	
89411	1.3	10	□	20/240
89412	1.6	10	□	20/240
89413	2.0	10	□	20/240
89414	2.4	10	□	12/144
89415	2.6	10	□	12/144
89416	3.0	10	□	12/144

EN Grass trimmer line
 PL Żyłka tnąca
 DE Mähfaden
 RU Леска для триммера
 CS Struna do strunové sekačky
 RO Furtun gradina
 HU Damil szegélynyíró géphez
 ES Hilo de cortar



FLO

No.	Ø [mm]	L [m]	Cutting line profile / Przekrój żyłki	
89421	1.3	15	☆	24/288
89422	1.6	15	☆	20/240
89423	2.0	15	☆	16/192
89424	2.4	15	☆	12/144
89425	2.6	15	☆	12/144
89426	3.0	15	☆	10/120

EN Grass trimmer line
 PL Żyłka tnąca
 DE Mähfaden
 RU Леска для триммера
 CS Struna do strunové sekačky
 RO Furtun gradina
 HU Damil szegélynyíró géphez
 ES Hilo de cortar

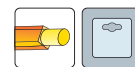

FLO

No.	Ø [mm]	L [m]	Cutting line profile / Przekrój żyłki	
89462	2.4	15	□	10/120
89463	2.7	15	□	10/120
89464	3.0	12	□	10/120

EN Grass trimmer line
 PL Żyłka tnąca
 DE Mähfaden
 RU Леска для триммера
 CS Struna do strunové sekačky
 RO Furtun gradina
 HU Damil szegélynyíró géphez
 ES Hilo de cortar

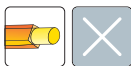

No.	Ø [mm]	L [m]	Cutting line profile / Przekrój żyłki	
89465	2.4	90		10/20
89466	2.7	70		10/20
89467	3.0	60		10/20

EN Grass trimmer line
 PL Żyłka tnąca
 DE Mähfaden
 RU Леска для триммера
 CS Struna do strunové sekačky
 RO Furtun gradina
 HU Damil szegélynyíró géphez
 ES Hilo de cortar



No.	Ø [mm]	L [m]	Cutting line profile / Przekrój żyłki	
89473	2.4	90		10/20
89474	2.7	70		10/20
89475	3.0	60		10/20

EN Grass trimmer line
 PL Żyłka tnąca
 DE Mähfaden
 RU Леска для триммера
 CS Struna do strunové sekačky
 RO Furtun gradina
 HU Damil szegélynyíró géphez
 ES Hilo de cortar



No.	Ø [mm]	L [m]	Cutting line profile / Przekrój żyłki	
89478	1.6	15		20/240
89479	2.0	15		20/240
89480	2.4	15		10/120
89481	2.7	15		10/120
89482	3.0	12		10/120

EN Brass straight connection
 PL Króciec mosiężny do pomp
 DE Messingstutzen für Pumpen
 RU Латунный патрубок для насосов
 CS Mosazná přípojka pro čerpadla
 RO Conector alama
 HU Sárgaréz csatlakozó szivattyúkhöz
 ES Conector de latón para bombas



No.	Hose diameter / Średnica węża	
79924	1" (25 mm)	10/80

EN Grass trimmer line
 PL Żyłka tnąca
 DE Mähfaden
 RU Леска для триммера
 CS Struna do strunové sekačky
 RO Furtun gradina
 HU Damil szegélynyíró géphez
 ES Hilo de cortar

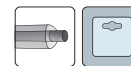

No.	Ø [mm]	L [m]	Cutting line profile / Przekrój żyłki	
89470	2.4	15		10/120
89471	2.7	15		10/120
89472	3.0	12		10/120

EN Grass trimmer line
 PL Żyłka tnąca
 DE Mähfaden
 RU Леска для триммера
 CS Struna do strunové sekačky
 RO Furtun gradina
 HU Damil szegélynyíró géphez
 ES Hilo de cortar



No.	Ø [mm]	L [m]	Cutting line profile / Przekrój żyłki	
89483	2.0	90		10/20
89484	2.4	90		10/20
89485	2.7	70		10/20
89486	3.0	60		10/20

EN Hose connection
 PL Przyłącze do węża do pomp zatapialnych
 DE Druckleitung-Anschlusstutze
 RU Соединитель для шланга
 CS Koloeno k hadici
 RO Ştuf de fixare furtun
 HU Tömítő csatlakozó
 ES Tubuladura para manguera para bombas de inmersiyn



No.	
79919	100

EN Drill chuck
 PL Głowica do wiertarki samozaciskowej
 DE Schnellspannbohrfutter
 RU Патрон сверлильный быстрозажимной
 CS Hlava na vrtáčku samosvorná
 RO Mandrină cu autostrângere pt. bormaşină
 HU Az önbeszorulás fűrőgéptokmányfej
 ES Cabezta para taladradora autoapriete



No.	Toolholder size / Rozmiar uchwyty narzędziowego [mm]	Thread size / Rozmiar gwintu	
79570	1-10	G3/8	10/40

EN Drill chuck
 PL Głowica do wiertarki samozaciskowej
 DE Schnellspanbohrfutter
 RU Патрон сверлильный быстрозажимной
 CS Hlava na vrtačku samosvorná
 RO Mandrină cu autostrângere pt. bormașină
 HU Az önbeszorulós fúrógéptokmányfej
 ES Cabeza para taladradora autoapriete

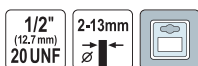

No.	Toolholder size / Rozmiar uchwyty narzędziowego [mm]	Thread size / Rozmiar gwintu	
79580	2-13	G1/2	5/40

EN Adapter SDS-plus - UNF 1/2"
 PL Adapter SDS-plus - UNF 1/2"
 DE Adapter SDS-plus - UNF 1/2"
 RU Переходник SDS-plus - UNF 1/2"
 CS Přenoska SDS-plus - UNF 1/2"
 RO Adaptor SDS-plus - UNF 1/2"
 HU Adapter SDS-plus - UNF 1/2"
 ES Adaptor SDS-plus - UNF 1/2"



No.	Thread size / Rozmiar gwintu	
79800	G1/2	12/144

EN Multipurpose drill bit sharpener
 PL Wielofunkcyjna ostrzałka do wiertel
 DE Vielzweck Bohrenschleifgerät
 RU Машина для заточки сверл
 CS Ostrůvka pro ostření vrtáků
 RO Mașină de ascuțit burghie
 HU Fúróélező
 ES Afiladora de brocas



$L_{pA} = 61,0 \pm 3,0$ dB; $L_{wA} = 74,0 \pm 3,0$ dB

No.	Power / Moc [W]	
73470	70	6

EN Drill chuck
 PL Głowica do wiertarki na klucz
 DE Schnellspanbohrfutter
 RU Патрон сверлильный ключевой
 CS Hlava na vrtačku na klíč
 RO Mandrină cu cheie pt. bormașină
 HU Az önbeszorulós fúrógéptokmányfej
 ES Cabeza para taladradora de llave



No.	Toolholder size / Rozmiar uchwyty narzędziowego [mm]	Thread size / Rozmiar gwintu	
79630	1.5-13	G1/2	5/40

EN Rotary sharpener
 PL Ostrzarka do wiertarki
 DE Bohrschärfer-Bohrmaschinenaufsatz
 RU Точило для ножей и ножиц

CS Brousek na nože a nůžky
 RO Rezerva pt dispozitiv de ascuțit burghie
 HU Élezőkő fúrógépbe fogható
 ES Muela afilar cuchillos y tijeras

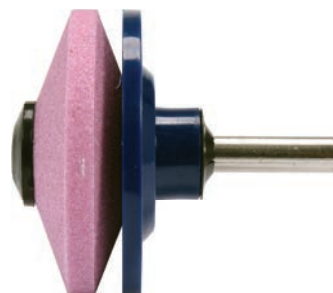

No.		
26225		80/240

EN Multi-function sharpener
 PL Ostrzałka wielofunkcyjna
 DE Multifunktionales Schärftgerät
 RU Многофункциональный заточный станок
 CS Viceúčelová bruska
 RO Mașină de ascuțit multifuncțională
 HU Multifunkciós élezőgép
 ES Afilador multifuncional



$L_{pA} = 81,56 \pm 3,0$ dB; $L_{wA} = 94,56 \pm 3,0$ dB

No.	Power / Moc [W]	
73473	150	2

- EN Angle grinder stand
 PL Stawak do szlifierki kątovej
 DE Winkelschleif-Trennstander
 RU Стенд для угловой шлифовальной машины
 CS Stojan pro úhlovou brusku
 RO Stativ pt. polizor unghiular
 HU Állvány sarokcsiszolóhoz
 ES Soporte para lijadora de ángulo



VOREL

No.	H [mm]	pcs / szt.
79641	4	4

- EN Drill stand
 PL Stawak do wiertarki
 DE Bohrmaschinen-Ständer
 RU Штатив для дрели
 CS Stativ do vrtačky
 RO Suport masina de gaurit
 HU Fúróállvány
 ES Soporte para taladro



VOREL

No.	H [mm]	pcs / szt.
79639	400	8

- EN Rotary file set
 PL Zestaw końcówek do szlifierki
 DE Profil-Fräser Satz
 RU Набор фрез
 CS Hrotové rašple
 RO Răşpeluri cu coadă
 HU Fareszelőkészlet, csapszárú
 ES Rotatorio archivos



No.	Chuck diameter / Średnica trzpienia [mm]	pcs / szt.
25450	6	5

- EN Drill stand
 PL Stojak do wiertarki
 DE Bohrmaschinenständer
 RU Сверлильная станция
 CS Stativ do vrtačky
 RO Suport masina de gaurit
 HU Fúróállvány
 ES Soporte para taladro



VOREL

No.	H [mm]	pcs / szt.
79640	400	10

- EN Spare cutting knife for electric planer
 PL Zapasowe ostrza do struga elektrycznego
 DE Hobelmesser für Elektrohobel
 RU Лезвия для электрорубана
 CS Náhradní nůž pro elektr. hoblíku
 RO Lamă de rezervă pt. rindea electrică
 HU Tartalék gyalukés elektromos gyalugéphez
 ES Filos de repuesto para cepillo eléctrico



STHOR

No.	pcs / szt.	pcs / szt.
79346	2	30/360

- EN Mounted stone set
 PL Kamienie szlifierskie trzpieniowe
 DE Schleifsteinaufsätze
 RU Набор абразивных наконечников
 CS Brsné kámeny hrotové
 RO Set pietre abrazive cu tijă
 HU Csiszolókő készlet, csapszárú
 ES Discos de esmeril

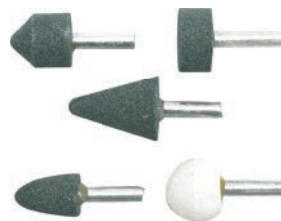

No.	Chuck diameter / Średnica trzpienia [mm]	pcs / szt.
25400	6	5

- EN Mini grinder accessories set
 PL Zestaw końcówek do szlifierki
 DE Schleifaufsätze
 RU Набор шлифовальных и полировочных насадок
 CS Soustava koncovek na brusku
 RO Set pietre abrazive si pasla pt. slefuit
 HU Fejkészlet csiszológéphez
 ES Juego de puntas de pulir



VOREL

No.	pcs / szt.	pcs / szt.
25410	13	10/50

EN Mini grinder accessories set
 PL Zestaw końcówek do szlifierki
 DE Schleifaufsätze
 RU Набор шлифовальных и полировочных насадок
 CS Soustava koncovek na brusku
 RO Set pietre abrazive si pasla pt. slefuit
 HU Fejkészlet csiszológéphez
 ES Juego de puntas de pulir

17
PCS

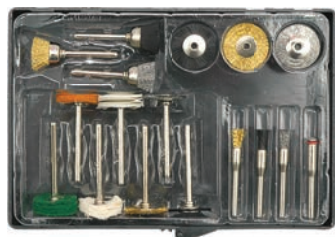

VOREL

No.	pcs / szt.	
25411	17	10/50

EN Rotary file set
 PL Tarniki trzpieniowe
 DE Profil-Fräser Satz
 RU Набор фрез
 CS Hrotové rašple
 RO Raspeluri cu coadă
 HU Fareszélőkészlet, csapszárás
 ES Rotatorio archivos

6
PCS

STEEL
STAINL

0-11000
min/r

40
mm

3.2 mm

HSS
4241



STHOR

No.	pcs / szt.	
25405	6	50/300

EN Glue sticks
 PL Wkłady klejowe
 DE Heissklebeatronen
 RU Тубы для клеящей пистолета
 CS Lepicí vložky
 RO Mine cu clei
 HU Ragasztóbetét
 ES Cartucho de cola

170-200
°C

85±2°C
SOFTENING
MIKNEKIE

TRANSPARENT
PRZECZYSTY

UNIVERSAL
UNIVERSALNY



APPLICATION:
 - Cardboard, wood, plastic,
 leather, fabrics

ZASTOSOWANIE:
 - Tektura, drewno, plastik,
 skóra, tkaniny

VOREL

No.	Ø [mm]	L [mm]	m [kg]	
73300	11	200	1	10

EN Helping hand with magnifying glass
 PL Zestaw „trzecia ręka”
 DE Hilfhand mit Lupe
 RU Комплект „третья ручка” с лупой
 CS Sada „třetí ruka”
 RO Ceva cu lupa
 HU Paneltartó állvány „harmadik kéz”
 ES Juego „la tercera mano” con lupa



No.	Glass diameter / Średnica szkła [mm]	
73300	62	10/40

EN Mini grinder accessories set
 PL Zestaw końcówek do szlifierki
 DE Schleifaufsätze
 RU Набор шлифовальных и полировочных насадок
 CS Soustava koncovek na brusku
 RO Set pietre abrazive si pasla pt. slefuit
 HU Fejkészlet csiszológéphez
 ES Juego de puntas de pulir

22
PCS



VOREL

No.	pcs / szt.	
25412	22	10/50

EN Polishing covers
 PL Nakładki polerujące
 DE Polierscheibe
 RU Полировочные накладки
 CS Lešticí kotouč
 RO Polizor captusit
 HU Polírozó korong
 ES Fundas

2
PCS

245
mm



VOREL

No.	Ø [mm]	For / Dla	pcs / szt.	
82941	245	82940	2	10/100

EN Glue sticks
 PL Wkłady klejowe
 DE Heissklebeatronen
 RU Тубы для клеящего пистолета
 CS Lepicí vložky
 RO Articole plastic (pt. pistol lipit)
 HU Ragasztóbetét
 ES Cartucho de cola

170-200
°C

85±2°C
SOFTENING
MIKNEKIE

TRANSPARENT
PRZECZYSTY

UNIVERSAL
UNIVERSALNY



APPLICATION:
 - Cardboard, wood, plastic,
 leather, fabrics

ZASTOSOWANIE:
 - Tektura, drewno, plastik,
 skóra, tkaniny

STHOR

No.	Ø [mm]	L [mm]	pcs / szt.	
73260	7	100	12	50/200
73270	11	100	6	20/120
73271	11	150	12	20/60

EN Soldering iron stand
 PL Stojak do lutownicy
 DE LötKolbenständer
 RU Подставка для паяльника
 CS Stojan na rájku
 RO Suport pt. ciocan lipit
 HU Forrasztópáka tartó
 ES Caballete de soldador



VOREL

No.		
79386		50

- EN Soldering accessories
- PL Zestaw narzędzi lutowniczych
- DE Lötzubehör
- RU Принадлежности для пайки
- CS Pájecí příslušenství
- RO Accesorii de lipit
- HU Forrasztó tartozékok
- ES Jooteseadmed tarvikud

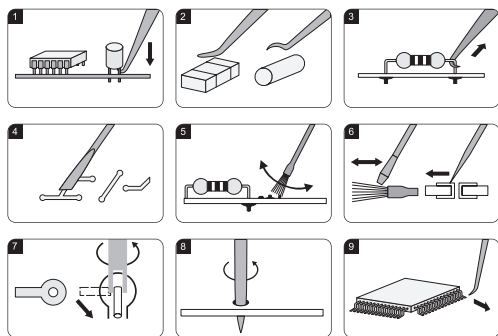

No.	pcs / szt.	Box icon
79398	6	25/100

- EN Solder
- PL Spoiwo lutownicze
- DE Lötzinn
- RU Припой
- CS Pájka
- RO Sarmă de sudură
- HU Forrasztó ón
- ES Estaño plata



No.	Ø [mm]	m [g]	Box icon
76830	1	16	25/250

- EN Solder stick
- PL Cyna w lasce
- DE Stangenlötzinn
- RU Припой
- CS Pájka v tyčkách
- RO Baghete de sudură
- HU Forrasztó rúd
- ES Barra estaño plomo



No.	Dimensions / Wymiary [mm]	m [kg]	Box icon
76832	7x7x322	5	1

- EN Solder
- PL Spoiwo lutownicze
- DE Lötzinn
- RU Припой
- CS Pájka
- RO Sarmă de sudură
- HU Forrasztó ón
- ES Estaño plata



No.	Ø [mm]	m [g]	Box icon
76800	0.5	100	30
76806	0.7	100	30
76807	0.7	250	20
76810	1.0	100	30
76811	1.0	250	20
76814	1.5	100	30
76815	1.5	250	20
76818	2.0	100	30
76819	2.0	250	20
76822	2.5	100	30
76823	2.5	250	20
76826	3.0	100	30

- EN Lead free solder
- PL Spoiwo lutownicze bezolowowe
- DE Bleifreier Lötdraht
- RU Бессвинцовый припой
- CS Bezolovnaté pájkové pojivo
- RO Roia fluidor fara plumb
- HU Ólommentes forrasztóon
- ES Estaño para soldar sin plomo



No.	Ø [mm]	m [g]	Box icon
76850	0.5	100	30
76851	0.7	100	30
76852	1.0	100	30
76853	1.0	250	20
76854	1.5	100	30
76855	1.5	250	20
76856	2.0	100	30
76857	2.0	250	20
76858	2.5	100	30
76859	3.0	100	30

EN Lead free solder in a phial
 PL Spoiwo lutownicze bezolowiowe fiołka
 DE Bleifreier Lötdraht im Spenderröhrchen
 RU Бесвинцовый припой флакон
 CS Bezolovnaté pájkové rojivo lahvička
 RO Fludor fara plumb, in tub
 HU Ólommentes forrasztóó fiola
 ES Estaño para soldar sin plomo, en ampolla



No.	Ø [mm]	m [g]	
76870	1.0	14	250

EN Solder rods without flux
 PL Pręty lutownicze bez topnika
 DE Lötstangen ohne Flussmittel
 RU Паяльные стержни без флюса
 CS Pájecí tyče bez tavidla
 RO Tijele de lipit fără flux
 HU Forrasztórúd gyanta nélkül
 ES Barras de soldadura sin fundente

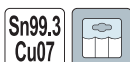

No.	Ø [mm]	m [g]	
76877	0.4	200	30

EN Solder paste
 PL Pasta lutownicza
 DE Lotpaste
 RU Паяльная паста
 CS Pájecí pasty
 RO Pasta decapante sudura
 HU Forrasztó paszta
 ES Pasta de soldar



No.	m [g]	
76835	40	50

EN Desoldering pump
 PL Odsysacz do cyny
 DE Entlötsaugpumpe
 RU Шприц для удаления припоя
 CS Odrájecí sací pumpra
 RO Pompa fludor
 HU Ónszippantó
 ES Bomba desoldadora



No.	
79390	100/400

EN Soft solder
 PL Spoiwo do instalacji miedzianych
 DE Lötdraht für Kupferinstallationen
 RU Припой для медных установок
 CS Rojivo pro měděné instalace
 RO Fludor moale
 HU Forrasztóó rézhez
 ES Aglutinante para instalaciones de cobre



No.	Ø [mm]	m [g]	
76880	1.5	100	60
76881	2.0	100	60
76882	2.0	250	50
76883	2.5	100	60
76884	2.5	250	50

EN Rosin
 PL Kalafonia lutownicza
 DE Kolophonium
 RU Канифоль
 CS Kalafuna
 RO Colofoniu
 HU Forrasztó gyanta
 ES Colofonia



No.	m [g]	
76836	45	50

EN Desoldering pump
 PL Odsysacz do cyny
 DE Entlötsaugpumpe
 RU Шприц для удаления припоя
 CS Odrájecí sací pumpra
 RO Pompa fludor
 HU Ónszippantó
 ES Bomba desoldadora



No.	
79391	70/140

EN Pumping hose for motor pumps with terminals
 PL Wąż tłoczny do motorpomp z końcówkami
 DE Druckschlauch für Motorpumpen mit Anschlussstücken
 RU Напорный рукав для моторной насосной станции с наконечниками
 CS Výtlačná hadice s koncovkami pro motorová čerpadla
 RO Furtun pt. motorpompe cu capete
 HU Szivattyú nyomótömlő kapcsokkal szerelve
 ES Manguera para bombear para motobombas con terminales



No.	L [m]	Ø	Max. operating pressure / Maks. ciśnienie robocze [bar]	Bursting pressure / Ciśnienie rozrywające [bar]	
79977	20	2" (50.0 mm)	6	24	1
79978	20	3" (75.0 mm)	6	24	1
79979	20	4" (100.0 mm)	6	24	1

EN Pumping hose for motor pumps
 PL Wąż tłoczny do motorpomp
 DE Druckschlauch für Motorpumpen
 RU Напорный рукав для моторной насосной станции
 CS Výtlačná hadice pro motorová čerpadla
 RO Furtun pt. motorpompe
 HU Szivattyú nyomótömlő
 ES Manguera para bombear para motobombas



No.	L [m]	Ø	Max. operating pressure / Maks. ciśnienie robocze [bar]	Bursting pressure / Ciśnienie rozrywające [bar]	
79982	50	1" (25.0 mm)	2	6	1
79983	50	2" (50.0 mm)	2	6	1
79984	50	3" (75.0 mm)	2	6	1



Memo

16

Welding equipment Sprzęt spawalniczy



Welding accessories
Akcesoria spawalnicze

288-293



Clamps	
Zaciski spawalnicze.....	288
Welding goggles & masks	
Okulary i maski spawalnicze.....	288
Hammers	
Miotki.....	291
Lock grip pliers & accessories	
Szcypce zaciskowe i akcesoria.....	291
Tin snips	
Nożyce do blachy.....	292

- EN Clamp
- PL Zacisk spawalniczy biegunowo-kleszczowy
- DE Schweisseklemme
- RU Клещи для сварки
- CS Kleště svářečské zemnicí
- RO Cleste pt. sudura
- HU Testkábel-csatlakozó
- ES Cocodrilo para soldar



No.	Max. welding current / Maks. prąd spawania [A]	Earthing cable diameter / Średnica przewodu masyowego [mm ²]	Max. jaws range / Maks. rozwarcie szczęk [mm]	m [kg]	Type / Typ	
74420	160	35	60	0.21	ZBK-35	25
74421	315	70	60	0.25	ZBK-70	25
74422	520	95	70	0.29	ZBK-95	25

- EN Welding goggles
- PL Okulary spawalnicze
- DE Schweisserbrille
- RU Очки газосварщика
- CS Brýle svářečské
- RO Ochelari pt. sudura
- HU Hegesztőszemüveg
- ES Gafas para soldar



No.	
74410	5/100

- EN Welding mask
- PL Maska spawalnicza
- DE Schweissermaske
- RU Щиток сварщика
- CS Svářečská maska
- RO Mască de sudură
- HU Hegesztőpajzs
- ES Mascara de soldador



No.	Type / Typ	
74440	TSM-3	30

- EN Electrode holder
- PL Uchwyt spawalniczy elektrodowy
- DE Schweisselectrodengriff
- RU Клещи для сварки (электродные)
- CS Držák elektrod
- RO Cleste pt. sudura cu electrod
- HU Elektrodafogó
- ES Abrazadera para soldar, de electrodos



No.	Max. welding current / Maks. prąd spawania [A]	Electrode diameter / Średnica elektrody [mm]	Welding cable diameter / Średnica przewodu spawalniczego [mm ²]	m [kg]	Type / Typ	
74430	200 (X=60%) / 315 (X=35%)	35-50	2-5	0.32	UE-200	25
74431	315 (X=60%) / 400 (X=35%)	50-70	2.5-6.3	0.42	UE-300	25
74432	430 (X=60%) / 530 (X=35%)	70-95	3.5-6.3	0.5	UE-400	25

- EN Welding goggles
- PL Okulary spawalnicze
- DE Schweisserbrille
- RU Очки газосварщика
- CS Brýle svářečské
- RO Ochelari pt. sudura
- HU Hegesztőszemüveg
- ES Gafas para soldar



No.	
74411	10/100

- EN Welding mask
- PL Maska spawalnicza
- DE Schweissermaske
- RU Щиток сварщика
- CS Svářečská maska
- RO Mască de sudură
- HU Hegesztőpajzs
- ES Mascara de soldador

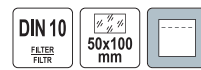

No.	Type / Typ	
74442	TSM	30

EN Welding mask
 PL Przyłbica spawalnicza z podglądem
 DE Schweissermaske
 RU Щиток сварщика с подсмотром
 CS Svářečská přilba s nakoukáním
 RO Mască de sudură cu geam
 HU Hegesztősisak kitekintővel
 ES Mascara de soldador con mirador



No.	Type / Typ	
74443	TSMP	20

EN Welding mask
 PL Maska spawalnicza
 DE Schweissermaske
 RU Щиток сварщика
 CS Svářečská maska
 RO Mască de sudură
 HU Hegesztőpajzs
 ES Mascara de soldador

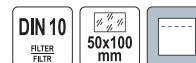

No.	Type / Typ	
74450	TSD-3	20

EN Welding mask
 PL Przyłbica spawalnicza z podglądem
 DE Schweissermaske
 RU Щиток сварщика с подсмотром
 CS Svářečská přilba s nakoukáním
 RO Mască de sudură cu geam
 HU Hegesztősisak kitekintővel
 ES Mascara de soldador con mirador

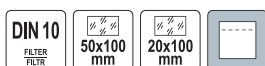

No.	Type / Typ	
74447	PSMP	20

EN Welding mask
 PL Przyłbica spawalnicza z podglądem
 DE Schweissermaske
 RU Щиток сварщика с подсмотром
 CS Svářečská přilba s nakoukáním
 RO Mască de sudură cu geam
 HU Hegesztőpajzs
 ES Mascara de soldador con mirador



No.	Type / Typ	
74448	PS-3	10

EN Welding mask
 PL Maska spawalnicza
 DE Schweissermaske
 RU Щиток сварщика
 CS Svářečská maska
 RO Mască de sudură
 HU Hegesztőpajzs
 ES Mascara de soldador



No.		
74441		20

EN Welding mask
 PL Przyłbica spawalnicza
 DE Schweissermaske
 RU Щиток сварщика
 CS Svářečská přilba
 RO Mască de sudură
 HU Hegesztőpajzs
 ES Mascara de soldador



No.		
74457		20

EN Auto-darkening welding helmet
 PL Przyłbica spawalnicza samościemniająca
 DE Schweissmaske, selbstverdunkelnd
 RU Маска сварщика с автозатемнением
 CS Svářečská kukla samostmivací
 RO Mască de sudură auto-întunecare
 HU Őnmagától sötétedő hegesztőpajzs
 ES Casco auto-oscurecedor para soldadura

9-13 DARK STATE STAN CIEMNY	SHADE SCIEMNIANIE	DIN 4 LIGHT STATE STAN JASNY	1 1 1 2 OPTICAL CLASS KLASA OPTYCZNA	92x42 mm
2 ARC SENSOR CZUJNIKI ŁUKU	1/15000s REACTION TIME CZAS REAKCJI	SENSITIVITY CZUŁOŚĆ	0.25-0.85s BRIGHTENING ROZJASNIANIE	DELAY OPÓZNIENIE
UV/IR	SOLAR CELL OGNIWO SŁONECZNE	3-POINT HEADGEAR WEZBA 3-PUNKTOWA	AUTO ON / OFF AUTO WL. WYL.	°C -5 +55
	MIG/MAG MMA/TIG	GRINDING AND WELDING SZLIFOWANIE I SPAWANIE		



STHOR

No.	
74480	6

EN Auto-darkening welding helmet
 PL Przyłbica spawalnicza samościemniająca
 DE Schweissmaske, selbstverdunkelnd
 RU Маска сварщика с автозатемнением
 CS Svářečská kukla samostmivací
 RO Mască de sudură auto-întunecare
 HU Őnmagától sötétedő hegesztőpajzs
 ES Casco auto-oscurecedor para soldadura

DIN 11 DARK STATE STAN CIEMNY	DIN 3 LIGHT STATE STAN JASNY	1 1 1 2 OPTICAL CLASS KLASA OPTYCZNA	100x50 mm	4 ARC SENSOR CZUJNIKI ŁUKU
1/25000s REACTION TIME CZAS REAKCJI	0,1-1,0 s BRIGHTENING ROZJASNIANIE	DIN 16 UV/IR	SOLAR CELL OGNIWO SŁONECZNE	2x CR2032
AUTO ON / OFF AUTO WL. WYL.	AUTOMATIC SENSITIVITY ADJUSTMENT AUTOMATYCZNA REGULACJA CZUŁOŚCI	3-POINT HEADGEAR WEZBA 3-PUNKTOWA	°C -5 +55	MIG/MAG MMA/TIG
		GRINDING AND WELDING SZLIFOWANIE I SPAWANIE		



STHOR

No.	
74484	6

EN Welding filter
 PL Filtr spawalniczy
 DE Vorsatzglas
 RU Фильтр для сварки
 CS Filtr svářečský
 RO Filtru pt. sudării
 HU Hegesztőszűrő
 ES Pantalla de filtro de soldador



No.	Filter size / Rozmiar filtra [mm]	Dark state / Stan ciemny [DIN]	
74452	50x100	8	100
74453	50x100	9	100
74454	50x100	10	100
74455	50x100	11	100

EN Auto-darkening welding helmet
 PL Przyłbica spawalnicza samościemniająca
 DE Schweissmaske, selbstverdunkelnd
 RU Маска сварщика с автозатемнением
 CS Svářečská kukla samostmivací
 RO Mască de sudură auto-întunecare
 HU Őnmagától sötétedő hegesztőpajzs
 ES Casco auto-oscurecedor para soldadura

DIN 11 DARK STATE STAN CIEMNY	DIN 3 LIGHT STATE STAN JASNY	1 1 1 2 OPTICAL CLASS KLASA OPTYCZNA	90x35 mm	2 ARC SENSOR CZUJNIKI ŁUKU
1/25000s REACTION TIME CZAS REAKCJI	0.4 s BRIGHTENING ROZJASNIANIE	DIN 15 UV/IR	SOLAR CELL OGNIWO SŁONECZNE	1x CR1029
3-POINT HEADGEAR WEZBA 3-PUNKTOWA	°C -5 +55	MIG/MAG MMA/TIG	GRINDING AND WELDING SZLIFOWANIE I SPAWANIE	



STHOR

No.	
74483	6

EN Filter shield
 PL Osłona filtra
 DE Filterabdeckung
 RU Кожух фильтра
 CS Ochrana filtru
 RO Apărătoare de filtru
 HU Szűrőfedél
 ES Protección de filtro

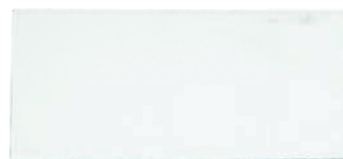

No.	Filter size / Rozmiar filtra [mm]	Dark state / Stan ciemny [DIN]	
74451	50x100	0	100

EN Self-dimming helmet filter protection
 PL Osłona filtra przyłbicy samościemniającej
 DE Filtereinsatz eines selbstabdunkelnden Schutzhelmes
 RU Кожух фильтра самозатемняющегося шитка
 CS Ochranná folie filtru samostmivací kukly
 RO Carcasă filtru vizieră heliomată
 HU Hegesztőpajzs szűrő, őnsötétedő
 ES Protección del filtro de visera autooscurecedora

5 PCS	PC
-----------------	-----------



No.	Filter size / Rozmiar filtra [mm]	pcs / szt.	
74439	90x110	5	20

EN Soft faced mallet
 PL Młotek blacharski, guma - plastik
 DE Ausbeulhammer
 RU Молоток рихтовочный комбинированный с деревянной ручкой

CS Klempířské kladívko
 RO Ciocan pt. tabla
 HU Bádógos kalapács
 ES Mazo goma-plástico

35 mm



No.	Head diameter / Średnica obucha [mm]	
33950	35	30/60

EN Welder's hammer
 PL Młotek spawalniczy
 DE Schweisserhammer
 RU Молоток сварщика

CS Svářečské kladívko
 RO Ciocan de sudură
 HU Hegesztő kalapács
 ES Martillo para soldar



JUCO

No.	m [g]	
32110	350	5

EN Welding locking pliers „C” type
 PL Szczypce zaciskowe klamrowe typu „C”
 DE Klemm- und Klammerzange vom Typ „C”
 RU Клещи зажимные сварочные
 CS Kleště samosvorné upínací typu „C”
 RO Clește de strângere cu clemă tip „C”
 HU „C” fogó
 ES Pinzas de tornillo (de apriete) de grapa tipo „C”

0-70 mm 280 mm



VOREL

No.	L [mm]	Type / Typ	
44301	280	C	5/30

EN Lock grip pliers
 PL Szczypce spawalnicze
 DE Schweisserzange
 RU Клещи зажимные сварочные
 CS Svářečské kleště
 RO Clește autoblocant pt. sudură
 HU Hegesztő fogó
 ES Alicates de soldar



No.	L [mm]	Type / Typ	
44500	250	SM	6/36

EN Wooden mallet
 PL Młotek drewniany blacharski
 DE Holzhammer für Bleche
 RU Молоток жестящика, деревянный

CS Palice dřevěná klempířská
 RO Ciocan din lemn de tinichigiu
 HU Bádógos fakalapács
 ES Martillo de madera de hojalatero



VOREL

No.	L [mm]	
33532	285	20

EN Lock grip pliers
 PL Szczypce spawalnicze
 DE Schweisserzange
 RU Клещи зажимные сварочные
 CS Svářečské kleště
 RO Clește autoblocant pt. sudură
 HU Hegesztő fogó
 ES Alicates de soldar

0-70 mm 275 mm



No.	L [mm]	Type / Typ	
44300	275	C	6/36

EN Lock grip pliers
 PL Szczypce spawalnicze
 DE Schweisserzange
 RU Клещи зажимные сварочные
 CS Svářečské kleště
 RO Clește autoblocant pt. sudură
 HU Hegesztő fogó
 ES Alicates de soldar

0-60 mm 225 mm



No.	L [mm]	Type / Typ	
44400	225	U	6/36

0-65 mm 250 mm 95 mm



- EN Mini locking pliers set
 PL Zestaw szczypiec spawalniczych mini
 DE Mini-Schweißzangen-Satz
 RU Набор сварочных мини-клещей
 CS Sada svařovacích kleští mini
 RO Set mini clești autoblocanti
 HU Mini testcsipesz készlet
 ES Juego de mini pinzas para soldar



- L=110 mm;
 L=125 mm;
 L=130 mm x2



No.	L [mm]	pcs / szt.	
44330	110, 125, 130, 130	4	6/24

- EN Figure tin snips
 PL Nożyce do blachy
 DE Blechscherer
 RU Ножницы по металлу
 CS Nůžky na plech
 RO Foarfece pt. tablă
 HU Lemezvágó olló
 ES Tijeras para hojalata



No.	L [mm]	Max. cutting capacity in cold-rolled steel / Maks. grubość cięcia w stali walcowanej na zimno [mm]	
48060	250	1.2	6/48

- EN Figure tin snips
 PL Nożyce do blachy
 DE Blechscherer
 RU Ножницы по металлу
 CS Nůžky na plech
 RO Foarfece pt. tablă
 HU Lemezvágó olló
 ES Tijeras para hojalata

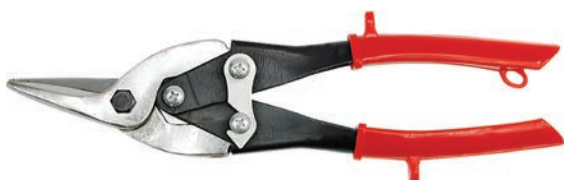

No.	L [mm]	
48100	250	6/60

- EN Figure tin snips
 PL Nożyce do blachy
 DE Blechscherer
 RU Ножницы по металлу
 CS Nůžky na plech
 RO Foarfece pt. tablă
 HU Lemezvágó olló
 ES Tijeras para hojalata

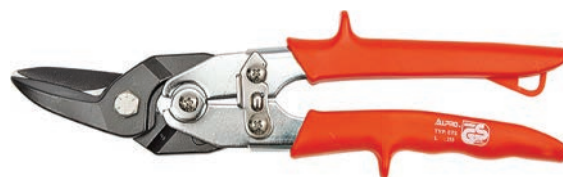

No.	L [mm]	Max. cutting capacity in cold-rolled steel / Maks. grubość cięcia w stali walcowanej na zimno [mm]	
48000	250	1.5	6/36

- EN Figure tin snips
 PL Nożyce do blachy
 DE Blechscherer
 RU Ножницы по металлу
 CS Nůžky na plech
 RO Foarfece pt. tablă
 HU Lemezvágó olló
 ES Tijeras para hojalata



No.	L [mm]	Max. cutting capacity in cold-rolled steel / Maks. grubość cięcia w stali walcowanej na zimno [mm]	
48080	250	1	6/36

- EN Figure tin snips
 PL Nożyce do blachy
 DE Blechscherer
 RU Ножницы по металлу
 CS Nůžky na plech
 RO Foarfece pt. tablă
 HU Lemezvágó olló
 ES Tijeras para hojalata



No.	L [mm]	Max. cutting capacity in cold-rolled steel / Maks. grubość cięcia w stali walcowanej na zimno [mm]	
48082	250	1	6/36

EN Figure tin snips
 PL Nożyce do blachy
 DE Blechscherer
 RU Ножницы по металлу
 CS Nůžky na plech
 RO Foarfece pt. tablă
 HU Lemezvágó olló
 ES Tijeras para hojalata



No.	L [mm]	
48200	250	6/60

EN Figure tin snips
 PL Nożyce do blachy
 DE Blechscherer
 RU Ножницы по металлу
 CS Nůžky na plech
 RO Foarfece pt. tablă
 HU Lemezvágó olló
 ES Tijeras para hojalata



VOREL

No.	L [mm]	Max. cutting capacity in cold-rolled steel / Maks. grubość cięcia w stali walcowanej na zimno [mm]	
48070	250	1.2	6/48

EN Figure tin snips
 PL Nożyce do blachy
 DE Blechscherer
 RU Ножницы по металлу

CS Nůžky na plech
 RO Foarfece pt. tablă
 HU Lemezvágó olló
 ES Tijeras para hojalata



No.	L [mm]	
48150	250	6/60

EN Figure tin snips
 PL Nożyce do blachy
 DE Blechscherer
 RU Ножницы по металлу
 CS Nůžky na plech
 RO Foarfece pt. tablă
 HU Lemezvágó olló
 ES Tijeras para hojalata



VOREL

No.	L [mm]	Max. cutting capacity in cold-rolled steel / Maks. grubość cięcia w stali walcowanej na zimno [mm]	
48050	250	1.5	6/36

EN Figure tin snips
 PL Nożyce do blachy
 DE Blechscherer
 RU Ножницы по металлу
 CS Nůžky na plech
 RO Foarfece pt. tablă
 HU Lemezvágó olló
 ES Tijeras para hojalata



VOREL

No.	L [mm]	Max. cutting capacity in cold-rolled steel / Maks. grubość cięcia w stali walcowanej na zimno [mm]	
48081	250	1	6/36

EN Figure tin snips
 PL Nożyce do blachy
 DE Blechscherer
 RU Ножницы по металлу
 CS Nůžky na plech
 RO Foarfece pt. tablă
 HU Lemezvágó olló
 ES Tijeras para hojalata

3
PCS



No.	L [mm]	pcs / szt.	
48330	250	3	5/20

17

Safes, padlocks & locks Sejfy, klódki i zamki



Safes
Sejfy

.....296

**Key boxes**
Skrzynki na klucze

.....296

**Cash boxes**
Kasetki na pieniądze

.....296-297

**Padlocks**
Kłódki

.....297-299

**Cast iron padlocks**

Kłódki żeliwne..... 297

Brass padlocks

Kłódki mosiężne..... 298

Steel padlocks

Kłódki stalowe..... 298

Lock cylinders & bodies
Wkładki do zamków i zamki

.....299-300

**Brass lock cylinders**

Wkładki mosiężne..... 299

Safety chains

Łańcuchy do drzwi..... 300

Door closers

Samozamykacze..... 300

Bicycle & motorcycle locks
Zamknięcia do rowerów i motocykli

.....301-302



EN Safe with digital lock
 PL Sejf z zamkiem cyfrowym
 DE Seif mit Digitalschloss
 RU Сейф с электронным замком

CS Pancéřová pokladna z digitálním zámkem
 RO Seif cu broasca cu cifru
 HU Számszáras széf
 ES Caja de seguridad con cerradura digital



No.	Dimensions / Wymiary [mm]	1
78641	350x250x250	1

EN Key box
 PL Skrzynka na klucze
 DE Schlüsselkasten
 RU Ящик для ключей
 CS Skříňka na klíče
 RO Cutie pt. chei
 HU Kulcstartó doboz
 ES Caja para llaves

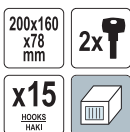

No.	Dimensions / Wymiary [mm]	20
78432	200x160x78	20

EN Key box
 PL Skrzynka na klucze
 DE Schlüsselkasten
 RU Ящик для ключей
 CS Skříňka na klíče
 RO Cutie pt. chei
 HU Kulcstartó doboz
 ES Caja para llaves



No.	Dimensions / Wymiary [mm]	5
78436	450x380x80	5

EN Cash box
 PL Kasetka na pieniądze
 DE Geldkassette
 RU Ящик для денег
 CS Kazeta na peníze
 RO Casetă (cutie) pt. bani
 HU Pénzes kasszetta
 ES Caja para efectivo



No.	Dimensions / Wymiary [mm]	Color / Kolor	10
78622	200x160x90	czarny	10

EN Safe with digital lock
 PL Sejf z zamkiem cyfrowym
 DE Seif mit Digitalschloss
 RU Сейф с электронным замком

CS Pancéřová pokladna z digitálním zámkem
 RO Seif cu broasca cu cifru
 HU Számszáras széf
 ES Caja de seguridad con cerradura digital



No.	Dimensions / Wymiary [mm]	1
78642	310x200x200	1

EN Key box
 PL Skrzynka na klucze
 DE Schlüsselkasten
 RU Ящик для ключей
 CS Skříňka na klíče
 RO Cutie pt. chei
 HU Kulcstartó doboz
 ES Caja para llaves



No.	Dimensions / Wymiary [mm]	10
78434	250x180x80	10

EN Cash box
 PL Kasetka na pieniądze
 DE Geldkassette
 RU Ящик для денег
 CS Kazeta na peníze
 RO Casetă (cutie) pt. bani
 HU Pénzes kasszetta
 ES Caja para efectivo

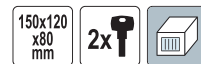

No.	Dimensions / Wymiary [mm]	Color / Kolor	20
78620	150x120x80	czarny	20

EN Cash box
 PL Kasetka na pieniądze
 DE Geldkassette
 RU Ящик для денег
 CS Kazeta na peníze
 RO Casetă (cutie) pt. bani
 HU Pénzes kasszetta
 ES Caja para efectivo

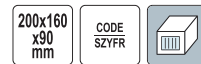

No.	Dimensions / Wymiary [mm]	Color / Kolor	10
78624	200x160x90	czarny	10

EN Cash box
 PL Kasetka na pieniądze
 DE Geldkassette
 RU Ящик для денег
 CS Kasetka na peníze
 RO Casetă (cutie) pt. bani
 HU Pénzes kasszeta
 ES Caja para efectivo

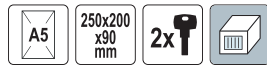

No.	Dimensions / Wymiary [mm]	Color / Kolor	Box icon
78626	250x200x90	czarny	10

EN Cash box
 PL Kasetka na pieniądze
 DE Geldkassette
 RU Ящик для денег
 CS Kasetka na peníze
 RO Casetă (cutie) pt. bani
 HU Pénzes kasszeta
 ES Caja para efectivo

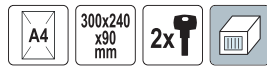

No.	Dimensions / Wymiary [mm]	Color / Kolor	Box icon
78630	300x240x90	czarny	10

EN Iron padlock
 PL Kłódka żelazna
 DE Vorhängeschloss
 RU Замок навесной
 CS Stavební visací zámek
 RO Lacăt pt. construcții
 HU Óriás lakat
 ES Candado de hierro fundido



No.	Size / Rozmiar [mm]	Box icon
77061	32	12/120
77062	38	12/120
77063	50	6/60
77064	63	6/36

EN Cash box
 PL Kasetka na pieniądze
 DE Geldkassette
 RU Ящик для денег
 CS Kasetka na peníze
 RO Casetă (cutie) pt. bani
 HU Pénzes kasszeta
 ES Caja para efectivo

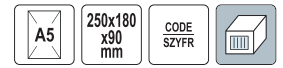

No.	Dimensions / Wymiary [mm]	Color / Kolor	Box icon
78628	250x180x90	czarny	10

EN Cash box
 PL Kasetka na pieniądze
 DE Geldkassette
 RU Ящик для денег
 CS Kasetka na peníze
 RO Casetă (cutie) pt. bani
 HU Pénzes kasszeta
 ES Caja para efectivo

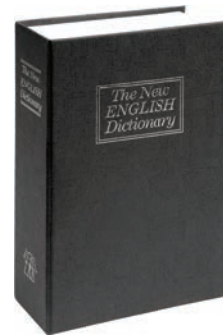

No.	Dimensions / Wymiary [mm]	Color / Kolor	Box icon
78632	180x115x55	czarny	24
78633	240x155x55	czarny	20

EN Alloy covered iron padlock
 PL Kłódka żelazna powlekana
 DE Vorhängeschloss
 RU Замок навесной
 CS Stavební visací zámek
 RO Lacăt pt. construcții
 HU Óriás lakat
 ES Candado de hierro fundido



No.	Size / Rozmiar [mm]	Box icon
77004	40	12/96
77005	50	12/72
77006	60	12/48

- EN Rectangular brass padlock
- PL Klódka trzpieniowa
- DE Messigvorhängeschloss
- RU Стержневой навесной замок латунный
- CS Visací zámek brávy
- RO Lacăt din alamă cu belciug drept
- HU Réz hengerzáras u lakat
- ES Candado de latón de mandril



No.	Size / Rozmiar [mm]	
77210	50	6/120
77211	65	6/96
77212	75	6/60
77213	90	6/36

- EN Brass combination padlock
- PL Klódka szyfrowa
- DE Vorhängeschloss
- RU Замок навесной
- CS Zámek visací s číselným klíčem
- RO Lacăt alama cu cifru
- HU Lakat sárgaréz számkombinációs
- ES Candado de latón



No.	
77607	12/120

17

- EN Safety padlock with nylon isolated body
- PL Klódka specjalna z korpusem zabezpieczonym tworzywem
- DE Spezielles Vorhängeschloss, Körper mit Kunststoff gesichert
- RU Специальный навесной замок с пластиковой защитой
- CS Speciální visací zámek, tělo zajištěno plastem
- RO Lacăt de siguranță cu corp izolat din nailon
- HU Speciális lakat műanyaggal védett ház
- ES Candado especial cuerpo, protegido con plástico



No.	
77100	10/100

- EN Plated brass padlock
- PL Klódka mosiężna
- DE Vorhängeschloss
- RU Замок навесной латунный
- CS Zámek visací mosazný
- RO Lacăt alama
- HU Lakat sárgaréz
- ES Candado de latón



No.	Size / Rozmiar [mm]	
77250	25	12/600
77300	30	12/480
77350	35	12/300
77400	40	12/240
77500	50	12/144
77600	60	12/144

- EN Plated brass padlock
- PL Klódka mosiężna
- DE Vorhängeschloss
- RU Замок
- CS Zámek visací mosazný
- RO Lacăt alama
- HU Lakat sárgaréz
- ES Candado de latón



No.	Size / Rozmiar [mm]	
77700	40x105	12/240

- EN Wire safety padlock with nylon isolation
- PL Klódka powlekana nylonem z linką
- DE Vorhängeschloss nylonbeschichtet mit Seil
- RU Навесной замок с нейлоновым покрытием и тросиком
- CS Visací zámek potažený nylonem s lankem
- RO Lacăt de siguranță cu fir cu izolație din nailon
- HU Nylon burkolatú huzalos lakat
- ES Candado revestido con nailon y cable



No.	
77105	10/120

EN Steel safety lock out hasp
 PL Stalowa blokada klamrowa
 DE Multi-Schließklammer aus Stahl
 RU Стальной замок-скоба
 CS Svrnková blokáda ocelová
 RO Siguranta blocare, oțel
 HU Acél lakatolható csatos zár
 ES Aldaba de seguridad de acero

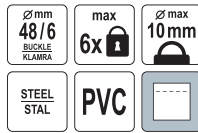

VOREL

No.	
77705	10/200

EN Lock cylinder
 PL Wkładka do zamka
 DE Schliesszylinder
 RU Личинка замка латунная

CS Vložka na zámek
 RO Yală pt. broască
 HU Zárbetét
 ES Inserción cromado



VOREL

No.	L [mm]	Size / Rozmiar [mm]	Key quantity / Liczba kluczy	
77200	62	31/31	3	12/72
77203	72	31/41	3	12/72
77204	67	31/36	3	12/72
77205	87	36/51	3	12/72

EN Lock cylinder
 PL Wkładka do zamka
 DE Schliesszylinder
 RU Личинка замка латунная

CS Vložka na zámek
 RO Yală pt. broască
 HU Zárbetét
 ES Inserción cromado



VOREL

No.	L [mm]	Size / Rozmiar [mm]	Key quantity / Liczba kluczy	
77190	62	31/31	6	12/72
77191	67	31/36	6	12/72
77192	72	31/41	6	12/72
77193	87	36/51	6	12/72

EN Aluminium safety lock out hasp
 PL Aluminiowa blokada klamrowa
 DE Multi-Schließklammer aus Aluminium
 RU Алюминиевый замок-скоба
 CS Svrnková blokáda hliníková
 RO Siguranta blocare, Al
 HU Alumínium lakatolható csatos zár
 ES Aldaba de seguridad de aluminio

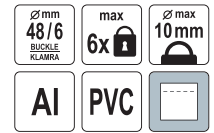

VOREL

No.	
77704	10/200

EN Lock cylinder
 PL Wkładka do zamka chromowana
 DE Schliesszylinder
 RU Личинка замка

CS Vložka na zámek
 RO Yală pt. broască
 HU Zárbetét
 ES Inserción cromado



VOREL

No.	L [mm]	Size / Rozmiar [mm]	Key quantity / Liczba kluczy	
77170	62	31/31	3	12/72

EN Lock cylinder
 PL Wkładka do zamka chromowana
 DE Schliesszylinder
 RU Личинка замка

CS Vložka na zámek
 RO Yală pt. broască
 HU Zárbetét
 ES Inserción cromado



VOREL

No.	L [mm]	Size / Rozmiar [mm]	Key quantity / Liczba kluczy	
77180	62	31/31	6	12/72

EN Safety chain
 PL Łańcuch do drzwi
 DE Türsicherungskette
 RU Замок-цепь для двери

CS Řetěz na dveře
 RO Lanț pt. ușă
 HU Ajtólánc
 ES Cadena para puerta



No.		
77900		12/120

EN Door closer
 PL Automacyjny zamykacz do drzwi
 DE Automatischer Türschließer
 RU Доводчик дверной
 CS Automatický zavírač dveří
 RO Încuietoare automată ușă
 HU Ajtófék
 ES Muelle de puerta

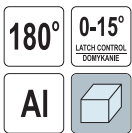

No.	Door weight / Căuțar skrzydła [kg]	
78464	40-65	10
78470	20-85	10

17

EN Door closer
 PL Automacyjny zamykacz do drzwi
 DE Automatischer Türschließer
 RU Доводчик дверной
 CS Automatický zavírač dveří
 RO Încuietoare automată ușă
 HU Ajtófék
 ES Muelle de puerta

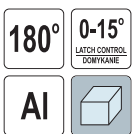

No.	Door weight / Căuțar skrzydła [kg]	
78466	40-65	10
78472	25-85	10

EN Safety chain
 PL Łańcuch do drzwi
 DE Türsicherungskette
 RU Замок-цепь для двери

CS Řetěz na dveře
 RO Lanț pt. ușă
 HU Ajtólánc
 ES Cadena para puerta



No.		
77910		12/120

EN Door closer
 PL Automacyjny zamykacz do drzwi
 DE Automatischer Türschließer
 RU Доводчик дверной
 CS Automatický zavírač dveří
 RO Încuietoare automată ușă
 HU Ajtófék
 ES Muelle de puerta

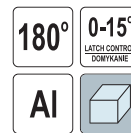

No.	Door weight / Căuțar skrzydła [kg]	
78465	40-65	10
78471	25-85	10

EN Key indicators
 PL Zawieszki plastikowe do kluczy
 DE Schlüsselanhänger
 RU Брелок для ключей
 CS Přívěšek na klíče
 RO Breloc
 HU Kulcstartó
 ES Llaveros de plástico



No.	pcs / szt.	
77930	12	12/120

EN Bicycle lock
 PL Linka rowerowa
 DE Fahrradschloss
 RU Замок велосипедный
 CS Zámek jízdního kola
 RO Antifurt pt. bicicleta
 HU Kerékpárzár
 ES Cable antirrobo para bicicletas



No.	L [cm]	Ø [mm]	Color / Kolor	
77830	65	8	czarny, niebieski, czerwony	12/120

EN Bicycle lock
 PL Linka rowerowa
 DE Fahrradschloss
 RU Замок велосипедный
 CS Zámek jízdního kola
 RO Antifurt pt. bicicleta
 HU Kerékpárzár
 ES Cable antirrobo para bicicletas



No.	L [cm]	Ø [mm]	Color / Kolor	
77831	65	8	czarny, niebieski, czerwony	12/120

EN Bicycle lock
 PL Linka rowerowa
 DE Fahrradschloss
 RU Замок велосипедный
 CS Zámek jízdního kola
 RO Antifurt pt. bicicleta
 HU Kerékpárzár
 ES Cable antirrobo para bicicletas



No.	L [cm]	Ø [mm]	Color / Kolor	
77837	120	8	czarny, niebieski, czerwony	10/60
77838	150	10	czarny, niebieski, czerwony	10/60

EN Bicycle lock
 PL Linka rowerowa
 DE Fahrradschloss
 RU Замок велосипедный
 CS Zámek jízdního kola
 RO Antifurt pt. bicicleta
 HU Kerékpárzár
 ES Cable antirrobo para bicicletas



No.	L [cm]	Ø [mm]	Color / Kolor	
77840	180	12	czarny, niebieski, czerwony	10/40



65 cm

Ø 8.0 mm



EN Bicycle lock
 PL Linka rowerowa
 DE Fahrradschloss
 RU Замок велосипедный
 CS Zámek jízdního kola
 RO Antifurt pt. bicicleta
 HU Kerékpárzár
 ES Cable antirrobo para bicicletas



No.	L [cm]	Ø [mm]	Color / Kolor	
77833	120	8	czarny, niebieski, czerwony	10/60
77834	120	10	czarny, niebieski, czerwony	10/60
77835	180	10	czarny, niebieski, czerwony	10/60

EN Bicycle lock
 PL Linka rowerowa
 DE Fahrradschloss
 RU Замок велосипедный
 CS Zámek jízdního kola
 RO Antifurt pt. bicicleta
 HU Kerékpárzár
 ES Cable antirrobo para bicicletas



No.	L [cm]	Ø [mm]	Color / Kolor	
77845	120	10	czarny, niebieski, czerwony	20/40

EN Security cable and lock
 PL Linka stalowa z kłódką
 DE Stahlseil, mit Vorhängeschloss
 RU Канат стальной с замком
 CS Ocelové lanko s visacím zámkem
 RO Sărmă de oțel cu lacăt
 HU Drótkötél, lakattal
 ES Cuerda de acero con candado



No.	L [cm]	Ø [mm]	
77815	3	4	12/48

EN Bicycle lock
 PL Zapięcie rowerowe
 DE Fahrradschloss
 RU Замок велосипедный
 CS Zámek jízdního kola
 RO Anti-furt pt. bicicleta
 HU Kerékpárzár
 ES Cable antirrobo para bicicletas



No.	L [cm]	Ø [mm]	
77850	100	18	12/24

EN Motorcycle lock
 PL Zapięcie motocyklowe
 DE Stahlgliederschloss
 RU Замок до мотоцикла
 CS Zámek na kolo
 RO Anti-furt motocicletă
 HU Láncaklat motorbiciklihez
 ES Candado para Moto



No.	L [cm]	Ø [mm]	
77861	150	25	6/12

EN Chain lock
 PL Zapięcie łańcuchowe z zamkiem
 DE Kettenverschluss mit Schloss
 RU Цепь с замком
 CS Bezpečnostní řetěz se zámkem
 RO Încuietoare lanț cu lacăt
 HU Kerékpár lánczár
 ES Candado de cadena con cerradura



No.	L [cm]	Ø [mm]	
77881	120	7	12

Memo

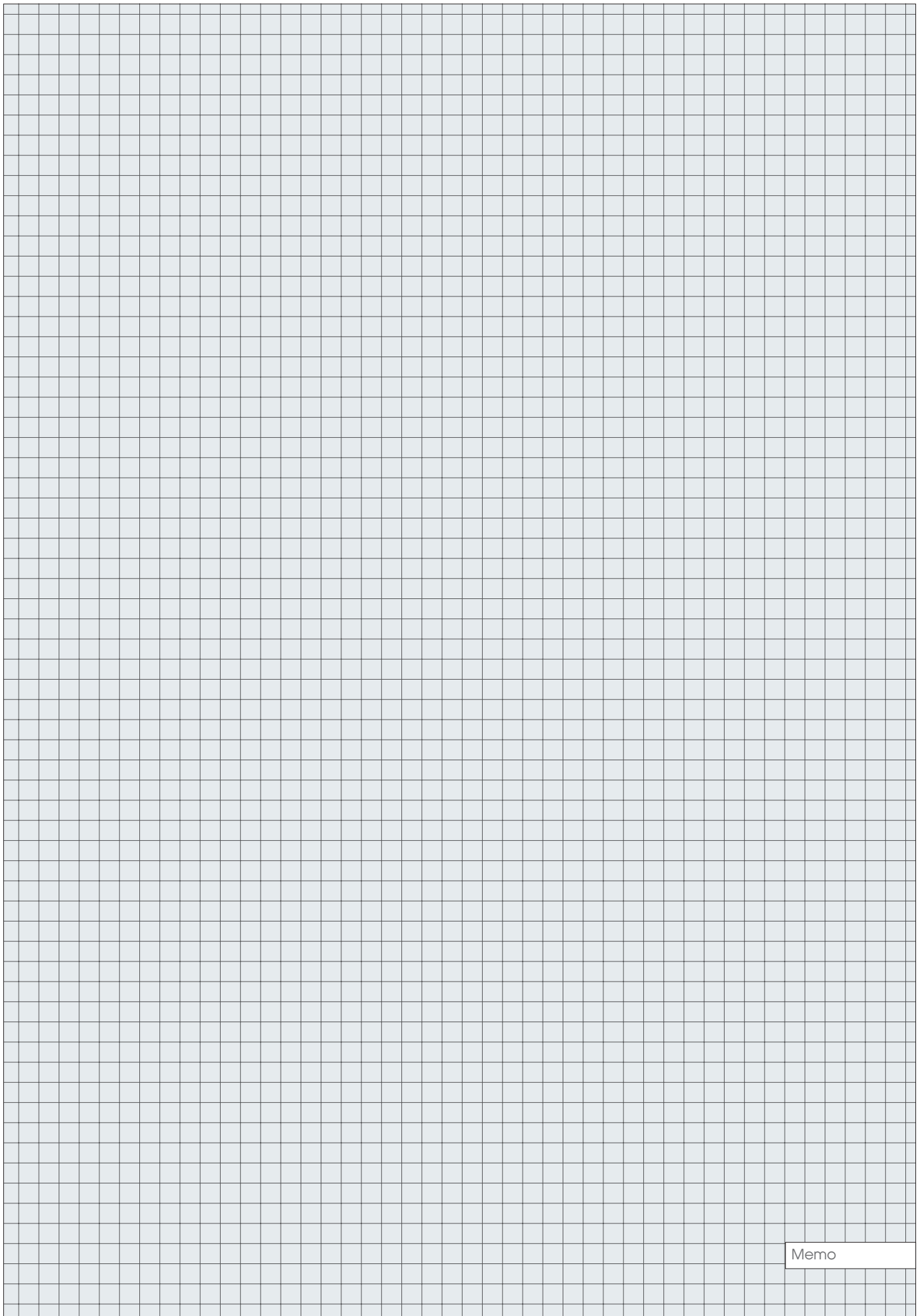

Memo



18

Accessories Akcesoria

Tool belts
Pasy na narzędzia

.....306



Tool bags
Torby narzędziowe

.....306



Trolley tool boxes
Wózki narzędziowe

.....306-307



Tool boxes
Skrzynki narzędziowe

.....307-309



- EN Tool belt with fixed bags
- PL Pas narzędziowy z naszytymi torbami
- DE Werkzeuggürtel mit Taschen
- RU Пояс для инструментов с карманами
- CS Opasek na nářadí s taškami
- RO Centura de scule cu pungii fixe
- HU Szerszám öv táská
- ES Cinturón para herramientas con bolsas



No.	
78751	24

- EN Tool belt
- PL Pas narzędziowy
- DE Werkzeuggürtel
- RU Инструмент пояса
- CS Opasek s nářadím
- RO Centura scule
- HU Szerszám öv
- ES Cinturón para herramientas



No.	
78750	50

- EN Tool bag
- PL Torba narzędziowa
- DE Werkzeugtasche
- RU Сумка для инструмента
- CS Taška montérská
- RO Geantă pt. scule
- HU Szerszámós táská
- ES Bolso de herramientas



No.	Dimensions / Wymiary [mm]	
78720	430x285x170	2

- EN Trolley toolbox, 2 segments
- PL Wózek narzędziowy 2-segmentowy
- DE Werkzeugtrolley 2-Teilig
- RU Мешок для инструментов 2 секции
- CS Vozík na nářadí 2 segmenty
- RO Troler pt. scule 2 segmente
- HU Kerek szerszámosláda 2 részese
- ES Carro de herramientas 2 compartimentos



No.	
78731	1

- EN Tool belt with sliding bags
- PL Pas narzędziowy stolarski z przesuwanymi torbami
- DE Werkzeuggürtel mit Taschen
- RU Пояс для инструментов со сменными карманами
- CS Opasek na nářadí s taškami
- RO Centura de scule cu pungii glisante
- HU Szerszám öv táská
- ES Cinturón para herramientas con bolsas



No.	
78752	24

- EN Tool bag
- PL Torba narzędziowa
- DE Werkzeuggöffer
- RU Сумка для инструмента
- CS Nástrojová taška
- RO Geantă pt. scule
- HU Szerszámóstáská
- ES Maletín de herramientas



No.	Dimensions / Wymiary [mm]	
78700	380x250x110	4
78710	455x280x130	2

- EN Tool bag
- PL Torba narzędziowa
- DE Werkzeugtasche
- RU Сумка для инструмента
- CS Taška montérská
- RO Geantă pt. scule
- HU Szerszámós táská
- ES Bolso de herramientas



No.	Dimensions / Wymiary [mm]	
78730	400x260x140	2



EN Trolley toolbox, 2 segments
 PL Wózek narzędziowy z wyjmowanym organizerem
 DE Werkzeugtrolley mit abnehmbarem Organizaeraufsatz
 RU Мешок для инструментов с вынимаемым организером
 CS Vozík na nářadí s odnímatelným organizérem
 RO Troler pt. scule 2 segmente
 HU Kerekesszerszámosláda kivethető szervezővel
 ES Carro de herramientas con organizador extraíble



No.	
78734	1

EN Trolley toolbox, 3 segments
 PL Wózek narzędziowy 3-segmentowy
 DE Werkzeugtrolley 3-Teilig
 RU Мешок для инструментов 3 секции
 CS Vozík na nářadí 3 segmenty
 RO Troler pt. scule 3 segmente
 HU Kerekesszerszámosláda 3 részes
 ES Carro de herramientas 3 compartimentos



No.	
78738	1

EN Trolley toolbox, 3 segments
 PL Wózek narzędziowy 3-segmentowy
 DE Werkzeugtrolley 3-Teilig
 RU Мешок для инструментов 3 секции
 CS Vozík na nářadí 3 segmenty
 RO Troler pt. scule 3 segmente
 HU Kerekesszerszámosláda 3 részes
 ES Carro de herramientas 3 compartimentos

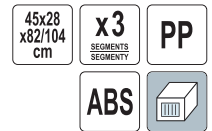

No.	
78736	1

EN Tool box
 PL Skrzynka narzędziowa
 DE Plastikwerkzeugkoffer
 RU Ящик для инструмента-пластмассовый

CS Nástrojová skřínka plastikov
 RO Cutie din plastic pt. scule
 HU Szerszámosláda, műanyag
 ES Caja de herramientas de plástico



No.	Size / Rozmiar	Dimensions / Wymiary [mm]	
78801	12" (30.0 cm)	312x167x130	1
78800	16" (40.0 cm)	415x226x200	1

EN Toolbox
 PL Skrzynka narzędziowa
 DE Werkzeugkoffer
 RU Инструментальный ящик

CS Nástrojová skřínka
 RO Cutie pt. scule
 HU Szerszámosláda
 ES Caja de herramientas



No.	Size / Rozmiar	Dimensions / Wymiary [mm]	
78802	20" (50.0 cm)	525x256x246	1

- EN Tool box
- PL Skrzynka narzędziowa
- DE Werkzeugkoffer
- RU Ящик для инструмента-пластмассовый
- CS Nástrojová skříňka plastikov
- RO Cutie din plastic pt. scule
- HU Szerszámosláda, műanyag
- ES Caja de herramientas de plástico



No.	Size / Rozmiar	Dimensions / Wymiary [mm]	
78811	12" (30.0 cm)	312x167x130	1
78812	16" (40.0 cm)	415x226x200	1
78813	20" (50.0 cm)	525x256x246	1
78815	26" (65.0 cm)	595x337x316	1

- EN Tool organiser with storage case
- PL Tablica narzędziowa z pojemnikami
- DE Werkzeugtafel mit Bechern
- RU Таблица для инструментов с контейнерами
- CS Organizér na nářadí s krabičkami
- RO Organizator + cutie depozitare scule
- HU Szerszámtartó fal tartályokkal
- ES Tablero de herramientas con recipientes

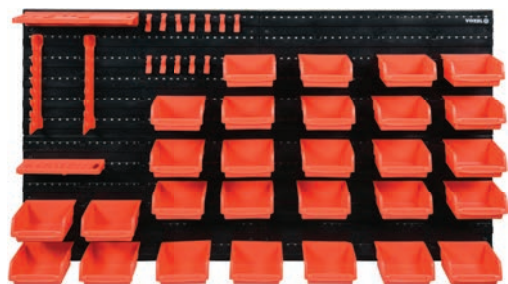

No.	Compartment dimensions / Wymiary modułu [mm]	pcs / szt.	
78771	475x272x15	48	1

- EN Organizer
- PL Organizer
- DE Werkzeugkaste
- RU Оправа́йзе́п
- CS Organizér
- RO Cutie tip organizator
- HU Csavartartó doboz
- ES Caja



No.	Dimensions / Wymiary [mm]	Compartment quantity / Liczba przegródek	
78790	200x145x35	7	10

- EN Toolbox
- PL Skrzynka narzędziowa
- DE Werkzeugkoffer
- RU Инструментальный ящик
- CS Nástrojová skříňka
- RO Cutie pt. scule
- HU Szerszámosláda
- ES Caja de herramientas



No.	Size / Rozmiar	Dimensions / Wymiary [mm]	Load capacity / Nośność [kg]	
78814	20" (50.0 cm)	525x256x325	25+3	1

- EN Workshop drawers
- PL Szufiadki warsztatowe
- DE Werkstattschubfächer
- RU Ящики для инструментов
- CS Skříňka se zásobníky
- RO Sertare atelier
- HU Műhely zsámoly fiókkal
- ES Cajones para taller



No.	Dimensions / Wymiary [mm]	Compartment quantity / Liczba przegródek	
78785	225x155x100	10	20

- EN Organizer
- PL Organizer
- DE Werkzeugkaste
- RU Оправа́йзе́п
- CS Organizér
- RO Cutie tip organizator
- HU Csavartartó doboz
- ES Caja



No.	Dimensions / Wymiary [mm]	Compartment quantity / Liczba przegródek	
78793	120x100x30	8	38

EN Organizer
 PL Organizer
 DE Werkzeugkaste
 RU Организаер
 CS Organizér
 RO Cutie tip organizator
 HU Csavartartó doboz
 ES Caja



No.	Dimensions / Wymiary [mm]	Compartment quantity / Liczba przegródek	
78791	300x220x55	10	10

EN Organizer
 PL Organizer
 DE Werkzeugkaste
 RU Организаер
 CS Organizér
 RO Cutie tip organizator
 HU Csavartartó doboz
 ES Caja



No.	Dimensions / Wymiary [mm]	
78794	360x270	5

EN Organizer
 PL Organizer
 DE Werkzeugkaste
 RU Организаер
 CS Organizér
 RO Cutie tip organizator
 HU Csavartartó doboz
 ES Caja



No.	Dimensions / Wymiary [mm]	
78819	460x320	5

EN Storage case
 PL Pojemnik magazynowy
 DE Lagersichtbox
 RU Ящик для склада
 CS Box skladovací
 RO Cutie scule diverse
 HU Tárolók
 ES Contenedeor de almacén



No.	Dimensions / Wymiary [mm]	Type / Typ	
78821	108x110x75	P-1	40
78822	160x115x75	P-2	40
78824	235x173x125	P-4	20
78825	340x200x150	P-5	9
78826	440x315x180	P-6	6

EN Storage case
 PL Pojemnik magazynowy
 DE Lagersichtbox
 RU Ящик для склада
 CS Box skladovací
 RO Cutie scule diverse
 HU Tárolók
 ES Contenedeor de almacén



18







No.	Dimensions / Wymiary [mm]	Type / Typ	
78830	116x112x75	XS	270
78831	116x161x75	S	190
78833	170x240x126	M	44
78834	204x340x155	L	27
78835	333x500x187	XL	7

19

Bicycle accessories Akcesoria rowerowe



Bicycle lamps Lampy rowerowe	
.....312	
Bicycle & motorcycle locks Zamknięcia do rowerów i motocykli	
.....312-313	
Bicycle pumps Pompki rowerowe	
.....314-315	
Bicycle tools Narzędzia rowerowe	
.....315	

EN LED bike light set
 PL Zestaw lamp rowerowych LED
 DE Fahrrad-Beleuchtungsset LED
 RU Набор светодиодных велосипедных фонарей
 CS Set LED osvětlení na kolo
 RO Set lanterna bicicleta LED
 HU LED kerékpár lámpa szett
 ES Juego de luces LED para bicicleta

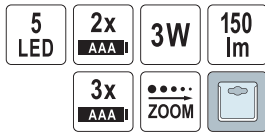

POWER
LED



No.	Battery type / Rodzaj baterii	
88422	3x1.5V; AAA, 2x1.5V; AAA	12/48

EN Bicycle lock
 PL Linka rowerowa
 DE Fahrradschloss
 RU Замок велосипедный
 CS Zámek jízdního kola
 RO Antifurt pt. bicicleta
 HU Kerékpárzár
 ES Cable antirrobo para bicicletas



No.	L [cm]	Ø [mm]	Color / Kolor	
77830	65	8	czarny, niebieski, czerwony	12/120

EN Bicycle lock
 PL Linka rowerowa
 DE Fahrradschloss
 RU Замок велосипедный
 CS Zámek jízdního kola
 RO Antifurt pt. bicicleta
 HU Kerékpárzár
 ES Cable antirrobo para bicicletas



No.	L [cm]	Ø [mm]	Color / Kolor	
77833	120	8	czarny, niebieski, czerwony	10/60
77834	120	10	czarny, niebieski, czerwony	10/60
77835	180	10	czarny, niebieski, czerwony	10/60

EN LED bike light set
 PL Zestaw lamp rowerowych LED
 DE Fahrrad-Beleuchtungsset LED
 RU Набор светодиодных велосипедных фонарей

CS Set LED osvětlení na kolo
 RO Set lanterna bicicleta LED
 HU LED kerékpár lámpa szett
 ES Juego de luces LED para bicicleta



POWER
LED



No.	Battery type / Rodzaj baterii	
88421	3x1.5V; AAA, 2x1.5V; AAA	12/120

EN Bicycle lock
 PL Linka rowerowa
 DE Fahrradschloss
 RU Замок велосипедный
 CS Zámek jízdního kola
 RO Antifurt pt. bicicleta
 HU Kerékpárzár
 ES Cable antirrobo para bicicletas



No.	L [cm]	Ø [mm]	Color / Kolor	
77831	65	8	czarny, niebieski, czerwony	12/120

EN Bicycle lock
 PL Linka rowerowa
 DE Fahrradschloss
 RU Замок велосипедный
 CS Zámek jízdního kola
 RO Antifurt pt. bicicleta
 HU Kerékpárzár
 ES Cable antirrobo para bicicletas



No.	L [cm]	Ø [mm]	Color / Kolor	
77837	120	8	czarny, niebieski, czerwony	10/60
77838	150	10	czarny, niebieski, czerwony	10/60

EN Bicycle lock
 PL Linka rowerowa
 DE Fahrradschloss
 RU Замок велосипедный
 CS Zámek jízdního kola
 RO Antifurt pt. bicicleta
 HU Kerékpárzár
 ES Cable antirrobo para bicicletas



No.	L [cm]	Ø [mm]	Color / Kolor	
77845	120	10	czarny, niebieski, czerwony	20/40

EN Security cable and lock
 PL Linka stalowa z kłódką
 DE Stahlseil, mit Vorhängeschloss
 RU Канат стальной с замком
 CS Ocelové lanko s visacím zámkem
 RO Sârmă de oțel cu lacăt
 HU Drótkötél, lakattal
 ES Cuerda de acero con candado



No.	L [cm]	Ø [mm]	
77815	3	4	12/48

EN Motorcycle lock
 PL Zapięcie motocyklowe
 DE Kettenverschluss
 RU Замок до мотоцикла
 CS Zámek na kolo
 RO Anti-furt motocicletă
 HU Láncakát motorbiciklihez
 ES Candado para Moto

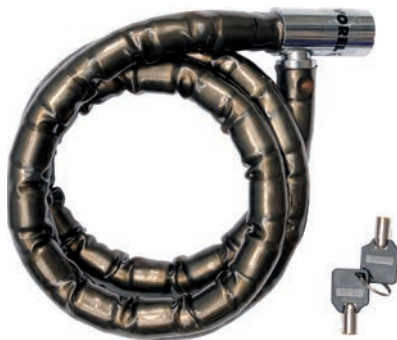

No.	L [cm]	Ø [mm]	
77861	150	25	6/12

EN Bicycle lock
 PL Linka rowerowa
 DE Fahrradschloss
 RU Замок велосипедный
 CS Zámek jízdního kola
 RO Antifurt pt. bicicleta
 HU Kerékpárzár
 ES Cable antirrobo para bicicletas



No.	L [cm]	Ø [mm]	Color / Kolor	
77840	180	12	czarny, niebieski, czerwony	10/40

EN Bicycle lock
 PL Zapięcie rowerowe
 DE Fahrradschloss
 RU Замок велосипедный
 CS Zámek jízdního kola
 RO Antifurt pt. bicicleta
 HU Kerékpárzár
 ES Cable antirrobo para bicicletas



No.	L [cm]	Ø [mm]	
77850	100	18	12/24

EN Chain lock
 PL Zapięcie łańcuchowe z zamkiem
 DE Kettenverschluss mit Schloss
 RU Цепь с замком
 CS Bezpečnostní řetěz se zámekem
 RO Încuietoare lanț cu lacăt
 HU Kerékpár lakat
 ES Candado de cadena con cerradura



No.	L [cm]	Ø [mm]	
77881	120	7	12

- EN Double cylinder aluminium hand pump
- PL Teleskopowa pompka aluminiowa
- DE Aluminium Handpumpe Doppelzylinder
- RU Насос телескопический алюминиевый
- CS Pumpa ruční double-pístové hliníkové
- RO Pompa aluminium duo telescope
- HU Pumpa aluminium dupla dugattyús
- ES Bomba de mano de doble cilindro de aluminio



No.	
82031	60

- EN Foot pump with gauge
- PL Pompka nożna z manometrem
- DE Fusspumpe
- RU Насос ножный с манометром
- CS Nožní pumpa s manometrem
- RO Pompă de picior cu manometru
- HU Lábpumpa nyomásmérővel
- ES Bomba de pieerna con manometro



No.	
82000	20

- EN Foot pump with gauge
- PL Pompka nożna z manometrem
- DE Fusspumpe
- RU Насос ножный с манометром
- CS Nožní pumpa s manometrem
- RO Pompă de picior cu manometru
- HU Lábpumpa nyomásmérővel
- ES Bomba de pieerna con manometro



No.	Measuring range / Zakres pomiaru [MPa]	
82001	0-0.7	12

19

- EN Hand pump
- PL Pompka słupkowa ręczna
- DE Hand-Luftpumpe
- RU Насос ручной
- CS Hustilka ruční
- RO Pompa de mana
- HU Kézi pumpa
- ES Bomba de barrote de mano



No.	Measuring range / Zakres pomiaru [MPa]	
82020	0-0.3	20

- EN Bike hand pump
- PL Pompka rowerowa
- DE Fahrradpumpe
- RU Велосипед ручной насос
- CS Pumpička na kolo
- RO Pompă de bicicletă
- HU Kerékpár pumpa
- ES Bomba de bicicleta

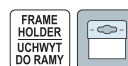

No.	
82032	60

- EN Foot pump with gauge
- PL Pompka nożna z manometrem
- DE Fusspumpe
- RU Насос ножный с манометром
- CS Nožní pumpa s manometrem
- RO Pompă de picior cu manometru
- HU Lábpumpa nyomásmérővel
- ES Bomba de pieerna con manometro



No.	Measuring range / Zakres pomiaru [MPa]	
82005	0-0.7	5

- EN Foot pump with gauge
- PL Pompka nożna z manometrem
- DE Fusspumpe
- RU Насос ножный с манометром
- CS Nožní pumpa s manometrem
- RO Pompă de picior cu manometru
- HU Lábpumpa nyomásmérővel
- ES Bomba de pieerna con manometro



No.	Measuring range / Zakres pomiaru [MPa]	
82015	0-0.7	6

- EN Hand pump with manometer
- PL Pompka słupkowa z manometrem
- DE Hand-Luftpumpe mit Manometer
- RU Насос ручной с манометром
- CS Pumpa s manometrem
- RO Pompa de mana cu manometru
- HU Kézi pumpa manométerrel
- ES Bomba de barrote con manometro



No.	Measuring range / Zakres pomiaru [MPa]	
82021	0-1	10

EN Hand pump with manometer
 PL Pompka słupkowa z manometrem
 DE Hand-Luftpumpe mit Manometer
 RU Насос ручной с манометром
 CS Pumpa s manometrem
 RO Pompa de mana cu manometru
 HU Kézi pumpa manométerrel
 ES Bomba de barrote con manometro



0-1.1 MPa
 60 cm
 UNIVERSAL DOUBLE HEAD
 UNIVERSALNA GŁOWICA PODWÓJNA



No.	Measuring range / Zakres pomiaru [MPa]	Icon
82022	0.1-1	10

EN Hex key set
 PL Zestaw kluczy imbusowych
 DE Sechskant-Stiftschlüsselsatz
 RU Набор шестигранников
 CS Imbusové klíče
 RO Chei imbus
 HU Imbisz kulcs
 ES Juego de llaves Hex

8 PCS

 25°
 CrV



No.	⌀ [mm]	pcs / szt.	Icon
56505	1.5, 2, 2.5, 3, 4, 5, 6, 8	8	25/100

EN Hex key set
 PL Zestaw kluczy imbusowych
 DE Sechskant-Stiftschlüsselsatz
 RU Набор шестигранников
 CS Imbusové klíče
 RO Chei imbus
 HU Imbisz kulcs
 ES Juego de llaves Hex

8 PCS

 CrV



No.	⌀ [mm]	pcs / szt.	Icon
56506	1.5, 2, 2.5, 3, 4, 5, 6, 8	8	25/100

EN Torx key set
 PL Zestaw kluczy Torx
 DE Torx Schlüsselsatz
 RU Набор ключи Torx
 CS Souprava klíčů Torx
 RO Set de chei Torx
 HU Kulcskészlet Torx
 ES Juego de llaves Torx

8 PCS

 CrV 6150



No.	Icon	pcs / szt.	Icon
56507	T9, T10, T15, T20, T25, T27, T30, T40	8	25/100

EN Bike hand tool set
 PL Zestaw do naprawy roweru
 DE Fahrrad-Reparatur-Satz
 RU Набор инструментов для велосипеда
 CS Cyklistické nářadí
 RO Instrumente ciclism
 HU Kerékpár szerszámok
 ES Herramientas ciclismo

18 PCS
 BOTTLE SHAPE KSZTALT BIDONU

INCLUDED:
 - HEX key 4, 5, 6 mm
 - Ratchet screwdriver
 - Adjustable wrench
 - 2 crowbars
 - Sockets 8, 9, 10 mm
 - Wheels spokes wrench
 - Bits set and adaptor
 - Tire repair kit

W ZESTAWIE:
 - Klucze imbusowe 4, 5, 6 mm
 - Wkręтак z grzechotką
 - Klucz nastawny
 - 2 łyzki do opon rowerowych
 - Nasadki 8, 9, 10 mm
 - Klucz do regulacji szprych
 - Zestaw końcówek wkręтакowych z adapterem
 - Zestaw naprawczy do dętek

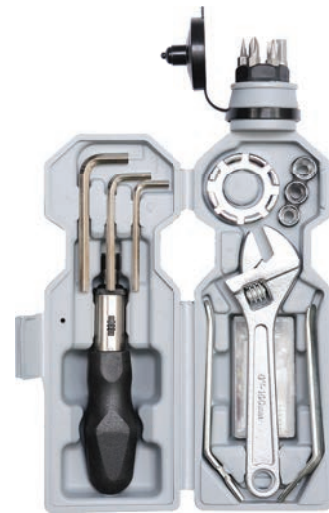

No.	Icon
77795	20

EN Bike repair stand
 PL Stojak do obsługi rowerów
 DE Fahrrad Montageständer
 RU Стенд для ремонта велосипедов
 CS Montážní stojan
 RO Stand pt. repararea bicicletei
 HU Kerékpár szerelő
 ES Soporte de reparación

105-145 cm
 360°
 max 30 kg
 max ⌀ 25-90 mm



No.	Icon
77715	2

20

Kitchen & home appliance
Sprzęt AGD



Kitchen appliance
Sprzęt AGD do kuchni



.....318-337

Home appliance
Sprzęt AGD do domu



.....337-345

EN Food processor
 PL Robot kuchenny
 DE Küchenmaschine
 RU Кухонный комбайн
 CS Kuchyňský robot
 RO Robot de bucatarie
 HU Robotgép
 ES Procesador de alimentos

- FUNCTIONS:**
- Chopping
 - Slicing
 - French-fries cutting
 - Shredding
 - Blending
 - Grinding
 - Whisking
 - Kneading

- FUNKCJE:**
- Siekanie
 - Krojenie na plastry
 - Cięcie na frytki
 - Tarcie
 - Blendowanie
 - Mielenie
 - Ubijanie
 - Ugniatanie



220-240V-50/60Hz	550 W	8 in 1 8 w 1
x2	PULSE MODE TRZY PULSACYJNY	∅ 75 mm
x4 SUCTION PADS PRZYSAWY	SS STAINLESS STEEL STAL NIERDZEWNA	



LUND

No.	Power / Moc [W]	
67950	550	2

EN Stand mixer
 PL Mikser planetarny
 DE Küchenmaschine
 RU Кухонный комбайн
 CS Kuchyňský robot
 RO Robotul multifunctional
 HU Komplex konyhai robotgép
 ES Robot de cocina

220-240V-50Hz	max 1400 W	800 W	5.5 L
x6	TURBO	SS STAINLESS STEEL STAL NIERDZEWNA	



LUND

No.	Power / Moc [W]	
67805	800	2

EN Multifunctional kitchen robot
 PL Robot kuchenny
 DE Küchenmaschine
 RU Кухонный робот
 CS Kuchyňský robot
 RO Roboti de bucatarie
 HU Robotgép
 ES Robot de cocina

220-240V-50/60Hz	150 W	3 in 1 3 w 1	180 min	
------------------	-------	-----------------	---------	--

- FUNCTIONS:**
- Thin slicing
 - Thick slicing
 - Thin shredding
 - Thick shredding
 - Puree blade

- FUNKCJE:**
- Krojenie cienkich plasterów
 - Krojenie grubych plasterów
 - Tarcie drobne
 - Tarcie grube
 - Tarcie placzków



LUND

No.	Power / Moc [W]	
67961	150	6

EN Stand mixer
 PL Mikser planetarny
 DE Küchenmaschine
 RU Кухонный комбайн
 CS Kuchyňský robot
 RO Robotul multifunctional
 HU Komplex konyhai robotgép
 ES Robot de cocina

230V~50Hz	1000 W
1.5 L	4.5 L
x6	TURBO



LUND

No.	Power / Moc [W]	
67810	1000	2

EN Stand mixer
 PL Mikser planetarny
 DE Küchenmaschine
 RU Кухонный комбайн
 CS Kuchyňský robot
 RO Robotul multifuncțional
 HU Komplex konyhai robotgép
 ES Robot de cocina



220-240V~ 50/60Hz	max 1500 W
1000 W	1.5 L
4.5 L	x6
TURBO	



LUND

No.	Power / Moc [W]	
67811	1000	2

EN Hand mixer
 PL Mikser ręczny
 DE Handmixer
 RU Ручной миксер
 CS Ruční mixér
 RO Mixer
 HU Kézi turmixgép
 ES Batidora de mano

220-240V~ 50-60Hz	200 W	x5
TURBO	SS STAINLESS STEEL STAL NIERDZEWNA	



LUND

No.	Power / Moc [W]	
67781	200	8

EN Hand mixer
 PL Mikser ręczny
 DE Handmixer
 RU Ручной миксер
 CS Ruční mixér
 RO Mixer
 HU Kézi turmixgép
 ES Batidora de mano

220-240V~ 50-60Hz	150 W	x5	
----------------------	----------	----	--



LUND

No.	Power / Moc [W]	
67780	150	10

EN Hand mixer with bowl
 PL Mikser ręczny z misą
 DE Handmixer mit Schale
 RU Ручной миксер с чашей
 CS Ruční mixér s mísou
 RO Mixer cu bol
 HU Kézi turmixgép tállal
 ES Batidora de mano con bol

220-240V~ 50-60Hz	200 W	3.0 L
x3	TURBO	AUTOMATIC ROTATING BOWL AUTOMATYCZNA ROTACJA MISY
	SS STAINLESS STEEL STAL NIERDZEWNA	



LUND

No.	Power / Moc [W]	
67790	200	6

EN Hand blender
 PL Blender ręczny
 DE Stabmixer
 RU Ручной блендер

CS Ruční mixér
 RO Blender de mana
 HU Botmixer
 ES Batidora de mano

INCLUDED:

- Blender 700 W
- Stainless steel blade
- Cup 0.5 l
- Stainless steel whisk
- Chopper 0.5 l with stainless steel blade
- BPA free tritan bottle 0.6 l with blade and cap
- Holder for blade and whisk

W ZESTAWIE:

- Blender 700 W
- Ostrze ze stali nierdzewnej
- Pojemnik 0.5 l
- Trzepaczka ze stali nierdzewnej
- Malakser 0.5 l z ostrzem ze stali nierdzewnej
- Butelka 0.6 l wolna od BPA, wykonana z tritanu, z ostrzem i zakrętką
- Podstawa na ostrze i trzepaczkę



220-240V-50/60Hz

700 W

TURBO

SPEED REGULATOR REGULACJA PREDKOŚCI

SS STAINLESS STEEL STAŁ NIERDZEWNA



LUND

No.	Power / Moc [W]	
67700	700	6

EN Smoothie blender
 PL Blender kielichowy do smoothie
 DE Standmixer
 RU Блендер

CS Smoothie mixér
 RO Smoothie blender
 HU Smoothie turmixgép
 ES Batidora smoothie

INCLUDED:

- Blender 300 W
- Stainless steel blade
- Jar 1 l
- Bottle 0.57 l
- Bottle 0.4 l

W ZESTAWIE:

- Blender 300 W
- Ostrze ze stali nierdzewnej
- Kielich 1 l
- Butelka 0.57 l
- Butelka 0.4 l



220-240V-50/60Hz

300 W

3 in 1
3 w 1

x2 PULS

x4 SUCTION PADS PRZYSSAWKI

SS STAINLESS STEEL STAŁ NIERDZEWNA



LUND

No.	Power / Moc [W]	
67702	300	6

EN Hand blender
 PL Blender ręczny
 DE Stabmixer
 RU Ручной блендер

CS Ruční mixér
 RO Blender de mana
 HU Botmixer
 ES Batidora de mano

INCLUDED:

- Blender 700 W
- Stainless steel blade
- Cup 0.5 l
- Stainless steel whisk
- Chopper 0.5 l with stainless steel blade
- 2 x BPA free tritan bottle 0.6 l with blade and cap
- Holder for blade and whisk
- Food processor 1.5 l with blade and 2-sided cutting plate

W ZESTAWIE:

- Blender 700 W
- Ostrze ze stali nierdzewnej
- Pojemnik 0.5 l
- Trzepaczka ze stali nierdzewnej
- Malakser 0.5 l z ostrzem ze stali nierdzewnej
- 2 x butelka 0.6 l wolna od BPA, wykonana z tritanu, z ostrzem i zakrętką
- Podstawa na ostrze i trzepaczkę
- Duży malakser 1.5 l z ostrzem i dwustronną tarką tnącą



220-240V-50/60Hz

700 W

TURBO

SPEED REGULATOR REGULACJA PREDKOŚCI

SS STAINLESS STEEL STAŁ NIERDZEWNA



LUND

No.	Power / Moc [W]	
67701	700	4

EN Smoothie blender
 PL Blender kielichowy do smoothie
 DE Standmixer
 RU Блендер

CS Smoothie mixér
 RO Smoothie blender
 HU Smoothie turmixgép
 ES Batidora smoothie

INCLUDED:

- Blender 500 W
- Stainless steel blade
- Glass jar 0.6 l
- Bottle 0.57 l
- Bottle 0.4 l
- Grinder

W ZESTAWIE:

- Blender 500 W
- Ostrze ze stali nierdzewnej
- Szklany kielich 0.6 l
- Butelka 0.57 l
- Butelka 0.4 l
- Młynek



220-240V-50/60Hz

500 W

40 mm

4 in 1
4 w 1

x3 SUCTION PADS PRZYSSAWKI



LUND

No.	Power / Moc [W]	
67703	500	4

EN Bottle
 PL Butelka
 DE Flasche
 RU Бутылка
 CS Láhev
 RO Sticla
 HU Üveg
 ES Botella

0.57L 



LUND

No.	Capacity / Pojemność [l]	For / Dla	
67709	0.57	67702, 67703	12

EN Portable blender USB
 PL Blender przenośny USB
 DE Mobilier USB-Stabmixer
 RU Портативный USB-блендер
 CS Přenosný USB mixér
 RO Blender portabil USB
 HU Hordozható USB turmix
 ES Licuadora portátil USB

7.4 V
1600mAh
Li-Ion

60 W

0.35L

1.5h

USB
BATTERY CHARGER
LADOWANIE



- Working time: 10-15 cycles
 - 1 cycle = 40 sec

- Czas pracy: 10-15 cykli
 - Cykl = 40 sek.



LUND

No.	Power / Moc [W]	
67710	60	10

EN Stand blender
 PL Blender kielichowy
 DE Standmixer
 RU Блендер
 CS Stolní mixér
 RO Blender
 HU Turmixgép
 ES Batidora de vaso

220-240V-50-60Hz

600 W

1.5L

∅ 50 mm

x5 PULS

ICE CRUSHING
KRUSZENIE LODU

ANTI-SLIP FEET
NÓZI ANTI-POŚLIZGOWE

SS
STAINLESS STEEL
STAL NIECZERNIA



INCLUDED:

- Blender 600 W
- Stainless steel blade
- Jar 1.5 l

W ZESTAWIE:

- Blender 600 W
- Ostrze ze stali nierdzewnej
- Kielich 1.5 l



LUND

No.	Power / Moc [W]	
67705	600	4

EN Slow juicer
 PL Wyciskarka wolnoobrotowa do soków
 DE Langsam laufende Saftpresse
 RU Соковыжималка шнековая
 CS Nízkootáčkový odšťavňovač
 RO Storcător de fructe
 HU Gyümölcscentrifuga
 ES Saca jugo

220-240V-50/60Hz

150 W

65 min⁻¹

3 FILTERS



FEATURES:

- Prepares fruit and vegetable juices, mousses, ice creams, dairy cocktails
- Keep more nutrition and original taste than traditional juicers
- Reverse gear
- Dishwasher safe for a quick and easy clean up
- Anti-drip cap
- Anti-slip feet
- Comfortable handle
- Low noise <60 db

CECHY:

- Możliwość przygotowania soków owocowych i warzywnych, przecierów, lodów i koktajli mlecznych
- Zachowuje więcej witamin i smaku niż tradycyjna sokowirówka
- Bieg wsteczny
- Szybkie i łatwe czyszczenie, możliwość mycia w zmywarce
- Korek niekapek
- Nóżki antypoślizgowe
- Wygodny uchwyt do przenoszenia
- Cicha praca <60 db



LUND

No.	Power / Moc [W]	
67840	150	2

EN Slow juicer
 PL Wyciskarka wolnoobrotowa do soków
 DE Langsam laufende Saftpresse
 RU Соковыжималка шнековая
 CS Nízkootáčkový odšťavňovač
 RO Storcator de fructe
 HU Gyümölcscentrifuga
 ES Saca jugo

FEATURES:

- Prepares fruit and vegetable juices, mousses, ice creams, dairy cocktails
- Keep more nutrition and original taste than traditional juicers
- Reverse gear
- Dishwasher safe for a quick and easy clean up
- Anti-drip cap
- Anti-slip feet
- Comfortable handle
- Low noise <60 db

CECHY:

- Możliwość przygotowania soków owocowych i warzywnych, przecierów, lodów i koktajli mlecznych
- Zachowuje więcej witamin i smaku niż tradycyjna sokowirówka
- Bieg wsteczny
- Szybkie i łatwe czyszczenie, możliwość mycia w zmywarce
- Korek niekapek
- Nóżki antypoślizgowe
- Wygodny uchwyt do przeniesienia
- Cicha praca <60 db



220-240V-50/60Hz
 150 W
 65 min⁻¹
 Ø 75 mm
 3 FILTERS
 SS STAINLESS STEEL STAL NIERDZEWNA



LUND

No.	Power / Moc [W]	
67841	150	2

EN Meat mincer
 PL Maszynka do mielenia mięsa
 DE Fleischwolf
 RU Мясодробилка
 CS Mlýnek na maso
 RO Masina de tocat
 HU Húsdaráló
 ES Picadora de carne

220-240V-50/60Hz
 1200 W
 4 in 1
 4 w 1
 2 kg/min
 x2
 REVERSE GEAR BIEG WSTECZNY
 SS STAINLESS STEEL STAL NIERDZEWNA



LUND

No.	Power / Moc [W]	
67901	1200	1

EN Meat mincer
 PL Maszynka do mielenia mięsa
 DE Fleischwolf
 RU Мясодробилка
 CS Mlýnek na maso
 RO Masina de tocat
 HU Húsdaráló
 ES Picadora de carne

220-240V-50Hz
 550 W
 5 in 1
 5 w 1
 1.5 kg/min
 REVERSE GEAR BIEG WSTECZNY
 SS STAINLESS STEEL STAL NIERDZEWNA



LUND

No.	Power / Moc [W]	
67900	550	4

EN Electric kettle
 PL Czajnik elektryczny
 DE Wasserkocher
 RU Электрический чайник
 CS Rychlovarná konvice
 RO Fierbator electric
 HU Elektromos vizforraló
 ES Hervidor eléctrico

220-240V-50/60Hz
 2200 W
 360°
 1.8 L
 SS STAINLESS STEEL STAL NIERDZEWNA

FEATURES:

- Automatic switch off
- Boil-dry protection
- Removable and washable filter
- Cable storage
- Cable length: 80 cm
- Stainless steel housing

CECHY:

- Automatyczne wyłączenie po zagotowaniu wody
- Ochrona przed przegrzaniem
- Filtr z możliwością wyjęcia i umycia
- Możliwość zwinięcia kabla pod podstawką
- Długość kabla: 80 cm
- Obudowa ze stali nierdzewnej



LUND

No.	Power / Moc [W]	
68172	1850-2200	8

EN Electric kettle
 PL Czajnik elektryczny
 DE Wasserkocher
 RU Электрический чайник
 CS Rychlovarná konvice
 RO Fierbator electric
 HU Elektromos vízforraló
 ES Hervidor eléctrico



FEATURES:

- Automatic switch off
- Boil-dry protection
- Cable storage
- Cable length: 80 cm
- Stainless steel housing
- Temperature control: 40-100° (40°-50°-60°-70°-80°-90°-100°)
- Keep warm

CECHY:

- Automatyczne wyłączenie po zagotowaniu wody
- Ochrona przed przegrzaniem
- Możliwość zwinięcia kabla pod podstawką
- Długość kabla: 80 cm
- Obudowa ze stali nierdzewnej
- Regulacja temperatury: 40-100° (40°-50°-60°-70°-80°-90°-100°)
- Funkcja utrzymywania temperatury



LUND

No.	Power / Moc [W]	Icon
68173	1850-2200	8

EN Electric kettle
 PL Czajnik elektryczny
 DE Wasserkocher
 RU Электрический чайник
 CS Rychlovarná konvice
 RO Fierbator electric
 HU Elektromos vízforraló
 ES Hervidor eléctrico

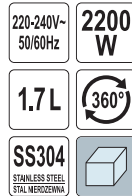

FEATURES:

- Automatic switch off
- Boil-dry protection
- Removable and washable filter
- Cable storage
- Cable length: 70 cm
- Water gauge
- Stainless steel 304 heating plate and body

CECHY:

- Automatyczne wyłączenie po zagotowaniu wody
- Ochrona przed przegrzaniem
- Filtr z możliwością wyjęcia i umycia
- Możliwość zwinięcia kabla pod podstawką
- Długość kabla: 70 cm
- Wskaźnik poziomu wody
- Płyta grzewcza oraz obudowa ze stali nierdzewnej 304



LUND

No.	Power / Moc [W]	Icon
68193	1850-2200	4

EN Electric kettle
 PL Czajnik elektryczny
 DE Wasserkocher
 RU Электрический чайник
 CS Rychlovarná konvice
 RO Fierbator electric
 HU Elektromos vízforraló
 ES Hervidor eléctrico



FEATURES:

- Automatic switch off
- Boil-dry protection
- Removable and washable filter
- Cable length: 75 cm
- Stainless steel housing
- Temperature control: 20-100° (20°-25°-30°-...-95°-100°)
- Keep warm

CECHY:

- Automatyczne wyłączenie po zagotowaniu wody
- Ochrona przed przegrzaniem
- Filtr z możliwością wyjęcia i umycia
- Długość kabla: 75 cm
- Obudowa ze stali nierdzewnej
- Regulacja temperatury: 20-100° (20°-25°-30°-...-95°-100°)
- Funkcja utrzymywania temperatury



LUND

No.	Power / Moc [W]	Icon
68174	1850-2200	6

EN Electric kettle
 PL Czajnik elektryczny
 DE Wasserkocher
 RU Электрический чайник
 CS Rychlovarná konvice
 RO Fierbator electric
 HU Elektromos vízforraló
 ES Hervidor eléctrico

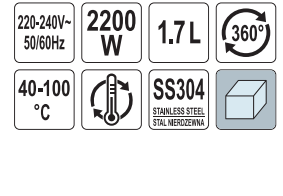

FEATURES:

- Automatic switch off
- Boil-dry protection
- Removable and washable filter
- Cable storage
- Cable length: 70 cm
- Water gauge
- Stainless steel 304 heating plate and body
- Temperature control (40-45-50-...-95-100)
- Keep warm

CECHY:

- Automatyczne wyłączenie po zagotowaniu wody
- Ochrona przed przegrzaniem
- Filtr z możliwością wyjęcia i umycia
- Możliwość zwinięcia kabla pod podstawką
- Długość kabla: 70 cm
- Wskaźnik poziomu wody
- Płyta grzewcza oraz obudowa ze stali nierdzewnej 304
- Regulacja temperatury (40-45-50-...-95-100)
- Funkcja utrzymywania temperatury



LUND

No.	Power / Moc [W]	Icon
68194	1850-2200	8

EN Electric kettle
 PL Czajnik elektryczny
 DE Wasserkocher
 RU Электрический чайник
 CS Rychlovarná konvice
 RO Fierbator electric
 HU Elektromos vízforraló
 ES Hervidor eléctrico



FEATURES:

- Automatic switch off
- Boil-dry protection
- Removable and washable filter
- Cable storage
- Cable length: 70 cm
- Water gauge
- Stainless steel 304 heating plate and body
- Temperature control (40-45-50...-95-100)
- Keep warm

CECHY:

- Automatyczne wyłączenie po zagotowaniu wody
- Ochrona przed przegrzaniem
- Filtr z możliwością wyjęcia i umycia
- Możliwość zwinięcia kabla pod podstawką
- Długość kabla: 70 cm
- Wskaźnik poziomu wody
- Płyta grzewcza oraz obudowa ze stali nierdzewnej 304
- Regulacja temperatury (40-45-50...-95-100)
- Funkcja utrzymywania temperatury



LUND

No.	Power / Moc [W]	Icon
68195	1850-2200	8

EN Pressure coffee maker
 PL Ekspres ciśnieniowy kolbowy
 DE Dampfdruck-Siebträger-Kaffeemaschine
 RU Кофемашина рожковая
 CS Pákový tlakový kávovar
 RO Espresso
 HU Karos eszpresszó kávéfőző
 ES Cafetera de presión con manivela



EN Air fryer
 PL Frytkownica beztłuszczowa
 DE Heissluftfritteuse
 RU Фритюрница
 CS Horkovzdušná fritéza
 RO Friteuză
 HU Olajstító olaj nélküül
 ES Freidora sin aceite

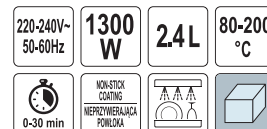

FEATURES:

- Up to 80% less oil than in conventional fryer
- Easy to use, timer and temperature control
- Dishwasher safe for a quick and easy clean up
- Faster heating up than in traditional oven
- Preparation: fries, meat, fish, vegetables, cakes and more

CECHY:

- Nawet 80% mniej oleju niż w standardowej frytkownicy
- Łatwa, intuicyjna obsługa dzięki regulacji temperatury i czasu
- Szybkie i łatwe czyszczenie, możliwość mycia w zmywarce
- Szybsze nagrzewanie niż w tradycyjnym piekarniku
- Przygotowanie m.in. frytek, mięsa, ryb, warzyw, ciastek

FUNCTIONS:

- Defrost
- Reheat
- Bake
- Fry
- Grill

FUNKCJE:

- Rozmraża
- Podgrzewa
- Piecze
- Smaży
- Grilluje



LUND

No.	Power / Moc [W]	Icon
67570	1300	1

EN Air fryer
 PL Frytkownica beztłuszczowa
 DE Heissluftfritteuse
 RU Фритюрница
 CS Horkovzdušná fritéza
 RO Friteuză
 HU Olajsütő olaj nélküli
 ES Freidora sin aceite



FEATURES:

- Up to 80% less oil than in conventional fryer
- Easy to use, timer and temperature control
- Dishwasher safe for a quick and easy clean up
- Faster heating up than in traditional oven
- Preparation: fries, meat, fish, vegetables, cakes and more

CECHY:

- Nawet 80% mniej oleju niż w standardowej frytkownicy
- Łatwa, intuicyjna obsługa dzięki regulacji temperatury i czasu
- Szybkie i łatwe czyszczenie, możliwość mycia w zmywarce
- Szybsze nagrzewanie niż w tradycyjnym piekarniku
- Przygotowanie m.in. frytek, mięsa, ryb, warzyw, ciastek



- | | |
|-------------------|-----------------|
| FUNCTIONS: | FUNKCJE: |
| - Defrost | - Rozmraża |
| - Reheat | - Podgrzewa |
| - Bake | - Piecze |
| - Fry | - Smaży |
| - Grill | - Grilluje |



LUND

No.	Power / Moc [W]	Box
67571	1300	1

EN Air fryer
 PL Frytkownica beztłuszczowa
 DE Heissluftfritteuse
 RU Фритюрница
 CS Horkovzdušná fritéza
 RO Friteuză
 HU Olajsütő olaj nélküli
 ES Freidora sin aceite



FEATURES:

- Up to 80% less oil than in conventional fryer
- Easy to use, timer and temperature control
- Dishwasher safe for a quick and easy clean up
- Faster heating up than in traditional oven
- Preparation: fries, meat, fish, vegetables, cakes and more

CECHY:

- Nawet 80% mniej oleju niż w standardowej frytkownicy
- Łatwa, intuicyjna obsługa dzięki regulacji temperatury i czasu
- Szybkie i łatwe czyszczenie, możliwość mycia w zmywarce
- Szybsze nagrzewanie niż w tradycyjnym piekarniku
- Przygotowanie m.in. frytek, mięsa, ryb, warzyw, ciastek



- | | |
|-------------------|-----------------|
| FUNCTIONS: | FUNKCJE: |
| - Defrost | - Rozmraża |
| - Reheat | - Podgrzewa |
| - Bake | - Piecze |
| - Fry | - Smaży |
| - Grill | - Grilluje |



LUND

No.	Power / Moc [W]	Box
67573	1800	1

EN Air fryer
 PL Frytkownica beztłuszczowa
 DE Heissluftfritteuse
 RU Фритюрница
 CS Horkovzdušná fritéza
 RO Friteuză
 HU Olajsütő olaj nélküli
 ES Freidora sin aceite

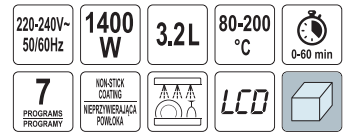

FEATURES:

- Up to 80% less oil than in conventional fryer
- Easy to use, timer and temperature control
- Dishwasher safe for a quick and easy clean up
- Faster heating up than in traditional oven
- Preparation: fries, meat, fish, vegetables, cakes and more

CECHY:

- Nawet 80% mniej oleju niż w standardowej frytkownicy
- Łatwa, intuicyjna obsługa dzięki regulacji temperatury i czasu
- Szybkie i łatwe czyszczenie, możliwość mycia w zmywarce
- Szybsze nagrzewanie niż w tradycyjnym piekarniku
- Przygotowanie m.in. frytek, mięsa, ryb, warzyw, ciastek



- | | |
|-------------------|-----------------|
| FUNCTIONS: | FUNKCJE: |
| - Defrost | - Rozmraża |
| - Reheat | - Podgrzewa |
| - Bake | - Piecze |
| - Fry | - Smaży |
| - Grill | - Grilluje |



LUND

No.	Power / Moc [W]	Box
67572	1400	1

EN Air fryer
 PL Frytkownica beztłuszczowa
 DE Heissluftfritteuse
 RU Фритюрница

CS Horkovzdušná fritéza
 RO Friteuză
 HU Olajsütő olaj nélküli
 ES Freidora sin aceite

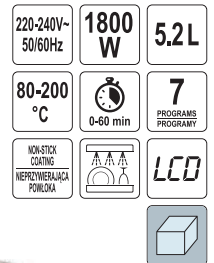

FEATURES:

- Up to 80% less oil than in conventional fryer
- Easy to use, timer and temperature control
- Dishwasher safe for a quick and easy clean up
- Faster heating up than in traditional oven
- Preparation: fries, meat, fish, vegetables, cakes and more

CECHY:

- Nawet 80% mniej oleju niż w standardowej frytkownicy
- Łatwa, intuicyjna obsługa dzięki regulacji temperatury i czasu
- Szybkie i łatwe czyszczenie, możliwość mycia w zmywarce
- Szybsze nagrzewanie niż w tradycyjnym piekarniku
- Przygotowanie m.in. frytek, mięsa, ryb, warzyw, ciastek



- | | |
|-------------------|-----------------|
| FUNCTIONS: | FUNKCJE: |
| - Defrost | - Rozmraża |
| - Reheat | - Podgrzewa |
| - Bake | - Piecze |
| - Fry | - Smaży |
| - Grill | - Grilluje |



LUND

No.	Power / Moc [W]	Box
67574	1800	1

EN Air fryer
 PL Frytkownica beztłuszczowa
 DE Heisluftfritteuse
 RU Фритюрница
 CS Horkovzdun friteza
 RO Friteuz
 HU Olajst olaj nlkl
 ES Freidora sin aceite

220-240V~50/60Hz **1800 W** **12 L** **30-200 °C** **10 PROGRAMS**
 NON-STICK COATING
 MĘPZYMWERALAKA POWLOKA
 LCD

FEATURES:

- Up to 80% less oil than in conventional fryer
- Easy to use, timer and temperature control
- Dishwasher safe for a quick and easy clean up
- Faster heating up than in traditional oven
- Preparation: fries, meat, fish, vegetables, cakes and more

CECHY:

- Nawt 80% mniej oleju ni w standardowej frytkownicy
- Latwa, intuicyjna obsuga dziki regulacji temperatury i czasu
- Szybkie i łatwe czyszczenie, moliwo mycia w zmywarce
- Szybsze nagrzewanie ni w tradycyjnym piekarniku
- Przygotowanie m.in. frytek, misa, ryb, warzyw, ciastek

FUNCTIONS:

- Defrost
- Reheat
- Bake
- Fry
- Grill
- Dry

FUNKCJE:

- Rozmraa
- Podgrzewa
- Piecze
- Smay
- Grilluje
- Suszy

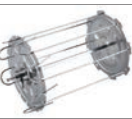
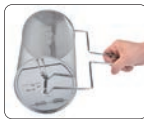
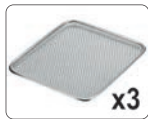

No.	Power / Moc [W]	
67590	1800	1

EN Halogen oven
 PL Kombiwar halogenowy
 DE Halogenofen
 RU Галогеновая печь
 CS Halogenov trouba
 RO Halogen cuptor
 HU Halogn st
 ES Horno halogeno

220-240V~50-60Hz **1400 W** **12+5L** **65-250 °C** **0-60 min**

FEATURES:

- Cooking time is 3 to 5 times faster than in conventional ovens
- Cooking without fats or oil
- Safe tempered glass body
- Low usage of electricity
- Excellent turbo wash function for self-cleaning
- Easy to use, timer and temperature control
- Evenly cooked foods (convection)

CECHY:

- Od 3 do 5 razy szybsze gotowanie w porwnaniu z tradycyjnymi piekarnikami
- Beztłuszczowe gotowanie bez oleju
- Bezpieczne, hartowane szko
- Niskie zuycie energii elektrycznej
- Skuteczna funkcja autoczyszczenia misy
- Latwa, intuicyjna obsuga dziki regulacji temperatury i czasu
- Rwnomierne gotowanie potraw (termoobieg)

FUNCTIONS:

- Thaw
- Reheat
- Bake
- Grill
- Broil
- Cook
- Steam

FUNKCJE:

- Odmraa
- Podgrzewa
- Piecze
- Grilluje
- Opieka
- Gotuje
- Gotuje na parze



ACCESSORIES: - Tongs
- Bread rack
AKCESORIA: - Szczypce
- Stojak na chleb

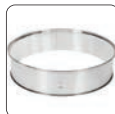

No.	Power / Moc [W]	
67641	1200-1400	1

EN Halogen oven
 PL Kombiwar halogenowy
 DE Halogenofen
 RU Галогеновая печь
 CS Halogenov trouba
 RO Halogen cuptor
 HU Halogn st
 ES Horno halogeno

220-240V~50-60Hz **1400 W** **12+5L** **65-250 °C** **0-60 min**

FEATURES:

- Cooking time is 3 to 5 times faster than in conventional ovens
- Cooking without fats or oil
- Safe tempered glass body
- Low usage of electricity
- Excellent turbo wash function for self-cleaning
- Easy to use, timer and temperature control
- Evenly cooked foods (convection)

CECHY:

- Od 3 do 5 razy szybsze gotowanie w porwnaniu z tradycyjnymi piekarnikami
- Beztłuszczowe gotowanie bez oleju
- Bezpieczne, hartowane szko
- Niskie zuycie energii elektrycznej
- Skuteczna funkcja autoczyszczenia misy
- Latwa, intuicyjna obsuga dziki regulacji temperatury i czasu
- Rwnomierne gotowanie potraw (termoobieg)

FUNCTIONS:

- Thaw
- Reheat
- Bake
- Grill
- Broil
- Cook
- Steam

FUNKCJE:

- Odmraa
- Podgrzewa
- Piecze
- Grilluje
- Opieka
- Gotuje
- Gotuje na parze



ACCESSORIES: - Tongs
- Bread rack
AKCESORIA: - Szczypce
- Stojak na chleb



No.	Power / Moc [W]	
67640	1200-1400	2

EN Halogen oven
 PL Kombiwar halogenowy
 DE Halogenofen
 RU Галогеновая печь
 CS Halogenov trouba
 RO Halogen cuptor
 HU Halogn st
 ES Horno halogeno

220-240V~50/60Hz **1400 W** **12+5L** **65-250 °C** **0-60 min**

FEATURES:

- Cooking time is 3 to 5 times faster than in conventional ovens
- Cooking without fats or oil
- Safe tempered glass body
- Low usage of electricity
- Excellent turbo wash function for self-cleaning
- Easy to use, timer and temperature control
- Evenly cooked foods (convection)

CECHY:

- Od 3 do 5 razy szybsze gotowanie w porwnaniu z tradycyjnymi piekarnikami
- Beztłuszczowe gotowanie bez oleju
- Bezpieczne, hartowane szko
- Niskie zuycie energii elektrycznej
- Skuteczna funkcja autoczyszczenia misy
- Latwa, intuicyjna obsuga dziki regulacji temperatury i czasu
- Rwnomierne gotowanie potraw (termoobieg)

FUNCTIONS:

- Thaw
- Reheat
- Bake

FUNKCJE:

- Odmraa
- Podgrzewa
- Piecze



FUNCTIONS: - Grill
- Broil
- Reheat
- Bake
FUNKCJE: - Grilluje
- Opieka
- Gotuje
- Gotuje na parze

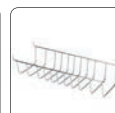
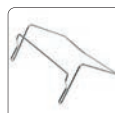

No.	Power / Moc [W]	
67642	1200-1400	1

EN Food dehydrator
 PL Suszarka spożywcza
 DE Lebensmittelrockner
 RU Сушилка для пищевых продуктов
 CS Sušička potravin
 RO Deshidrator alimente
 HU Ételszártó
 ES Secador de alimentos

DRIES:

- Fruit, vegetables, flowers, mushrooms, herbs, meat and much more

SUSZY:

- Owoce, warzywa, kwiaty, grzyby, zioła, mięso i wiele więcej

220-240V~ 50-60Hz	500 W
31x29.5 cm TRAYS TACA	35-70 °C
5 TRAYS TACE	

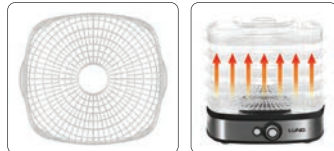

LUND

No.	Power / Moc [W]	
68270	420-500	4

EN Food dehydrator
 PL Suszarka spożywcza
 DE Lebensmittelrockner
 RU Сушилка для пищевых продуктов

CS Sušička potravin
 RO Deshidrator alimente
 HU Ételszártó
 ES Secador de alimentos

DRIES:

- Fruit, vegetables, flowers, mushrooms, herbs, meat and much more

SUSZY:

- Owoce, warzywa, kwiaty, grzyby, zioła, mięso i wiele więcej

220-240V~ 50-60Hz	500 W
32.5x30 cm TRAYS TACA	35-70 °C
0.5-19.5 h	6 TRAYS TACE

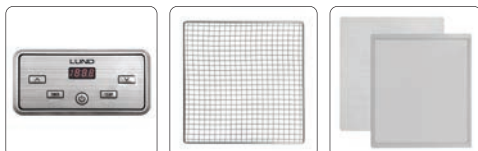

LUND

No.	Power / Moc [W]	
68272	420-500	2

EN Food dehydrator
 PL Suszarka spożywcza
 DE Lebensmittelrockner
 RU Сушилка для пищевых продуктов

CS Sušička potravin
 RO Deshidrator alimente
 HU Ételszártó
 ES Secador de alimentos

DRIES:

- Fruit, vegetables, flowers, mushrooms, herbs, meat and much more

SUSZY:

- Owoce, warzywa, kwiaty, grzyby, zioła, mięso i wiele więcej

220-240V~ 50-60Hz	500 W
31x29.5 cm TRAYS TACA	35-70 °C
0.5-19.5 h	5 TRAYS TACE



LUND

No.	Power / Moc [W]	
68271	420-500	4

EN Food dehydrator
 PL Suszarka spożywcza
 DE Lebensmittelrockner
 RU Сушилка для пищевых продуктов

CS Sušička potravin
 RO Deshidrator alimente
 HU Ételszártó
 ES Secador de alimentos

DRIES:

- Fruit, vegetables, flowers, mushrooms, herbs, meat and much more

SUSZY:

- Owoce, warzywa, kwiaty, grzyby, zioła, mięso i wiele więcej

220-240V~ 50-60Hz	700 W
32.5x30 cm TRAYS TACA	35-70 °C
0.5-19.5 h	9 TRAYS TACE

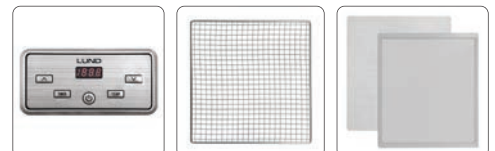

LUND

No.	Power / Moc [W]	
68273	600-700	1

- EN Tray for food dehydrator
- PL Tacka do suszarki spozywczej
- DE Tablett für Dörrgerät
- RU Лоток для пищевой сушилки
- CS Táč do sušičky potravin
- RO Tava pt. deshidratarea alimentelor
- HU Tálca ételszáritóhoz
- ES Bandeja para secador de alimentos

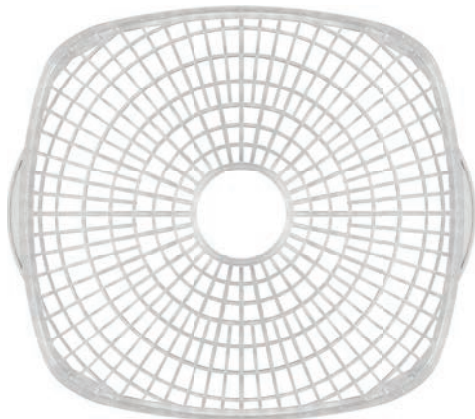

LUND

No.	Size / Rozmiar [mm]	For / Dla	
68269	310x295	68270, 68271	6

- EN Slow cooker
- PL Wolnowar
- DE Schongarer
- RU Медленноварка
- CS Pomalý hrnec
- RO Oala gatit cu abur
- HU Lassúfőző edény
- ES Olla de cocción lenta

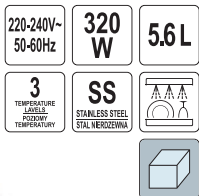

- FUNCTIONS:**
- Low temperature
 - High temperature
 - Keep warm

- FUNKCJE:**
- Niska temperatura
 - Wysoka temperatura
 - Podtrzymywanie ciepła



LUND

No.	Power / Moc [W]	
67661	320	2

- EN Slow cooker
- PL Wolnowar
- DE Schongarer
- RU Медленноварка
- CS Pomalý hrnec
- RO Oala gatit cu abur
- HU Lassúfőző edény
- ES Olla de cocción lenta

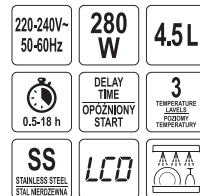

- FUNCTIONS:**
- Low temperature
 - High temperature
 - Keep warm

- FUNKCJE:**
- Niska temperatura
 - Wysoka temperatura
 - Podtrzymywanie ciepła



LUND

No.	Power / Moc [W]	
67660	280	2

- EN Toaster
- PL Toster
- DE Toaster
- RU Тостер
- CS Opékač topinek
- RO Aparat de prajit paine
- HU Kenyérpirító
- ES Tostadora

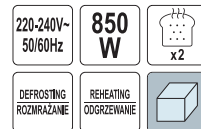

LUND

No.	Power / Moc [W]	
67500	700-850	6

EN Toaster CS Opékač topinek
 PL Toster RO Aparat de prajit paine
 DE Toaster HU Kenyérpirító
 RU Тостер ES Tostadora

220-240V~
50/60Hz

1500 W

x4

DEFROSTING
ROZMRAZANIE

REHEATING
ODGRZEWANIE



LUND

No.	Power / Moc [W]	Icon
67501	1300-1500	4

EN Sandwich maker
 PL Opiekacz
 DE Waffeleisen
 RU Сэндвичница
 CS Sendvičovač
 RO Aparat pt. sandwich
 HU Szendvicssütő
 ES Gratinador

220-240V~
50/60Hz

750 W

x2

NON-STICK
COATING
NEPRZYWIERAJĄCA
POWŁOKA



LUND

No.	Power / Moc [W]	Icon
67524	750	6

EN Sandwich maker CS Sendvičovač
 PL Opiekacz RO Aparat pt. sandwich
 DE Waffeleisen HU Szendvicssütő
 RU Сэндвичница ES Gratinador

220-240V~
50/60Hz

750 W

21.5x12.5
cm

NON-STICK
COATING
NEPRZYWIERAJĄCA
POWŁOKA



LUND

No.	Power / Moc [W]	Icon
67523	750	6

EN Sandwich maker
 PL Opiekacz
 DE Waffeleisen
 RU Сэндвичница
 CS Sendvičovač
 RO Aparat pt. sandwich
 HU Szendvicssütő
 ES Gratinador

220-240V~
50/60Hz

750 W

23x14.5
cm

NON-STICK
COATING
NEPRZYWIERAJĄCA
POWŁOKA



LUND

No.	Power / Moc [W]	Icon
67526	750	6

EN Sandwich maker
 PL Opiekacz
 DE Waffeleisen
 RU Сэндвичница
 CS Sendvičovač
 RO Aparat pt. sandwich
 HU Szendvicssütő
 ES Gratinador

220-240V-50/60Hz
760 W
 21.5x13.5 cm
 x2
 x2
3 in 1
3 w 1
 NON-STICK COATING
 NIEPRZYWIERAJĄCA POWŁOKA



LUND

No.	Power / Moc [W]	
67525	640-760	6

EN Sandwich maker
 PL Opiekacz
 DE Waffeleisen
 RU Сэндвичница
 CS Sendvičovač
 RO Aparat pt. sandwich
 HU Szendvicssütő
 ES Gratinador

220-240V-50-60Hz
1300 W
 25x21 cm
 x4
 CERAMIC PLATE FILTER CERAMICZNA
 NON-STICK COATING
 NIEPRZYWIERAJĄCA POWŁOKA



LUND

No.	Power / Moc [W]	
67521	1100-1300	5

EN Sandwich maker
 PL Opiekacz
 DE Waffeleisen
 RU Сэндвичница
 CS Sendvičovač
 RO Aparat pt. sandwich
 HU Szendvicssütő
 ES Gratinador

220-240V-50/60Hz
900 W
 28x15 cm
 x2
3 in 1
3 w 1
 NON-STICK COATING
 NIEPRZYWIERAJĄCA POWŁOKA



LUND

No.	Power / Moc [W]	
67530	900	3

EN Sandwich maker
 PL Opiekacz
 DE Waffeleisen
 RU Сэндвичница
 CS Sendvičovač
 RO Aparat pt. sandwich
 HU Szendvicssütő
 ES Gratinador

220-240V-50/60Hz
1400 W
 25x21 cm
 x4
 NON-STICK COATING
 NIEPRZYWIERAJĄCA POWŁOKA



LUND

No.	Power / Moc [W]	
67520	1400	4

EN Cookie maker
 PL Opiekacz do ciastek
 DE Plätzchen-Toaster
 RU Вафельница для печенья
 CS Orpěkač na cookies
 RO Aparat pt. fursecuri
 HU Sütemény készítő gép
 ES Tostadora de galletas



LUND

No.	Power / Moc [W]	
67527	1400	6

EN Contact grill
 PL Grill elektryczny
 DE Kontaktgrill
 RU Контактный гриль
 CS Kontaktní gril
 RO Gratar electric
 HU Elektromos grillsütő
 ES Parrilla de contacto

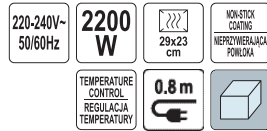

LUND

No.	Power / Moc [W]	
67451	2200	3

EN Contact grill
 PL Grill elektryczny
 DE Kontaktgrill
 RU Контактный гриль

CS Kontaktní gril
 RO Gratar electric
 HU Elektromos grillsütő
 ES Parrilla de contacto

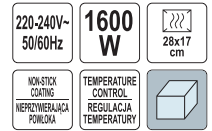

LUND

No.	Power / Moc [W]	
67458	1600	3

EN Contact grill
 PL Grill elektryczny
 DE Kontaktgrill
 RU Контактный гриль
 CS Kontaktní gril
 RO Gratar electric
 HU Elektromos grillsütő
 ES Parrilla de contacto

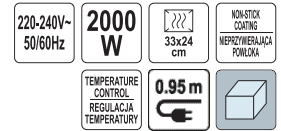

LUND

No.	Power / Moc [W]	
67456	2000	3

EN Contact grill
 PL Grill elektryczny
 DE Kontaktgrill
 RU Контактный гриль
 CS Kontaktní gril
 RO Gratar electric
 HU Elektromos grillsütő
 ES Parrilla de contacto

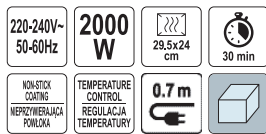

LUND

No.	Power / Moc [W]	
67457	2000	3

EN Table grill
 PL Grill stolowy elektryczny
 DE Tischgrill
 RU Настольный гриль
 CS Elektrický stolní gril
 RO Gratar electric
 HU Elektromos asztali grill
 ES Plancha de asar

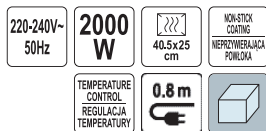

LUND

No.	Power / Moc [W]	
67455	2000	2

EN Table grill
 PL Grill stolowy elektryczny
 DE Tischgrill
 RU Настольный гриль
 CS Elektrický stolní gril
 RO Gratar electric
 HU Elektromos asztali grill
 ES Plancha de asar

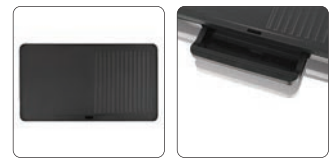
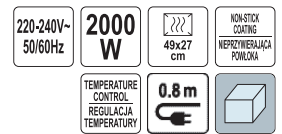

LUND

No.	Power / Moc [W]	
67453	2000	4

EN Electric grill
 PL Grill elektryczny
 DE Elektrogrill
 RU Электрический гриль
 CS Elektrický gril
 RO Gratar electric
 HU Elektromos grill
 ES Barbacoa eléctrica



LUND

No.	Power / Moc [W]	
67420	2000-2200	1

EN Waffle maker
 PL Gofrownica
 DE Waffeleisen
 RU Вафельница
 CS Vařovač
 RO Aparat de preparat waffle
 HU Gofrisütő
 ES Gofrera



LUND

No.	Power / Moc [W]	Box
68011	850	4

EN Crepe maker
 PL Naleśnikarka
 DE Kreppmacher
 RU Плита для блинов
 CS Plošna na palačinky
 RO Aparat pt. clătite
 HU Palacsintasütő
 ES Crepera eléct

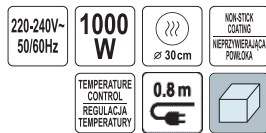

LUND

No.	Power / Moc [W]	Box
67470	1000	6

EN Waffle maker
 PL Gofrownica
 DE Waffeleisen
 RU Вафельница
 CS Vařovač
 RO Aparat de preparat waffle
 HU Gofrisütő
 ES Gofrera



LUND

No.	Power / Moc [W]	Box
68012	1100	4

EN Pizza maker
 PL Piec do pizzy
 DE Pizzenofen
 RU Печь для пиццы
 CS Pec na pizzu
 RO Aparat preparat pizza
 HU Pizzasütő kemence
 ES Homo para pizza

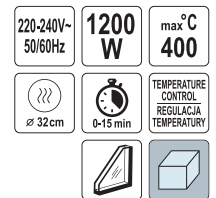

LUND

No.	Power / Moc [W]	Box
67480	1200	1

- EN Pizza oven stone
- PL Kamień do pieca na pizzę
- DE Pizzafen-Steinplatte
- RU Камень для печи для пиццы
- CS Kámen do pece na pizzu
- RO Tava piatra pt. pizza
- HU Pizzakő kemencebe
- ES Piedra de horno para pizza



LUND

No.	Ø [mm]	For / Dla	
67481	320	67480	5

- EN Vacuum sealer
- PL Pakowarka próżniowa
- DE Vakuuierer
- RU Вакуумный упаковщик
- CS Vakuová balíčka
- RO Aparat de ambalare in vid
- HU Vákuum csomagolóhoz
- ES Envasadora al vacio



Bags not included

Produkt nie zawiera worków w zestawie



LUND

No.	Power / Moc [W]	
67880	140	12

- EN Vacuum sealer
- PL Pakowarka próżniowa
- DE Vakuuierer
- RU Вакуумный упаковщик
- CS Vakuová balíčka
- RO Aparat de ambalare in vid
- HU Vákuum csomagolóhoz
- ES Envasadora al vacio

20



Bags not included

Produkt nie zawiera worków w zestawie

LUND

No.	Power / Moc [W]	
67882	175	6



- EN Vacuum sealer
- PL Pakowarka próżniowa
- DE Vakuuierer
- RU Вакуумный упаковщик
- CS Vakuová balíčka
- RO Aparat de ambalare in vid
- HU Vákuum csomagolóhoz
- ES Envasadora al vacio



LUND

No.	Power / Moc [W]	
67877	130	6

- EN Vacuum sealer
- PL Pakowarka próżniowa
- DE Vakuuierer
- RU Вакуумный упаковщик
- CS Vakuová balíčka
- RO Aparat de ambalare in vid
- HU Vákuum csomagolóhoz
- ES Envasadora al vacio



LUND

No.	Power / Moc [W]	
67881	165	6

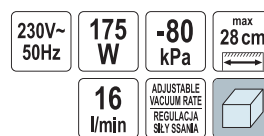

EN Vacuum bags
 PL Worki moletowane
 DE Goffrierte Vakuumbbeutel
 RU Пакеты с накаткой для вакуумной упаковки
 CS Vroubkované vakuové sáčky
 RO Pungi pt. vidat gofrate
 HU Légszatomnás vákuumtasakok
 ES Bolsas gofradas para envasar al vacío



LUND

No.	Size / Rozmiar [cm]	Thickness / Grubość [µm]	For / Dla	pcs / szt.	
67887	20x30	90	67880	50	24
67888	25x35	90	67880, 67882	50	14
67889	30x40	90	67881, 67877	50	12

EN Vacuum food container
 PL Pojemnik próżniowy na żywność
 DE Vakuumbehälter
 RU Вакуумный контейнер
 CS Vakuová dóza na potraviny
 RO Cutie alimente cu sistem vacuum
 HU Vákuumos doboz
 ES Tarros de vacío

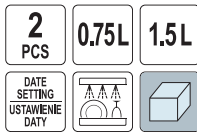

FEATURES:
 - Help to keep freshness and taste
 - Possibility to set a date on the lid

CECHY:
 - Pomaga zachować świeżość i smak
 - Możliwość zaznaczenia daty na pokrywie



LUND

No.	Capacity / Pojemność [l]	
67890	0.75, 1.5	12

EN Kitchen scale
 PL Waga kuchenna
 DE Küchenwaage
 RU Кухонные весы
 CS Kuchyňská váha
 RO Cantar bucatarie
 HU Konyhamérleg
 ES Báscula de cocina

FEATURES:
 - Weight units: oz, g, kg, lb
 - Removeable bowl

CECHY:
 - Jednostki wagi: oz, g, kg, lb
 - Możliwość wyjęcia misy

LUND

No.	Max. load capacity / Maks. obciążenie [g]	
68361	5000	12

EN Vacuum sealer roll
 PL Folia moletowana w rolce
 DE Goffrierte Vakuumrolle
 RU Фольга с накаткой в рулоне
 CS Vakuovací vroubkovaná fólie na roli
 RO Rola folie gofrata pt. vidat
 HU Vákuumfólia tekercs
 ES Rollo gofrado para envasar al vacío



LUND

No.	Size / Rozmiar [cm]	Thickness / Grubość [µm]	For / Dla	
67883	25x600	105	67881, 67882, 67877	42
67884	28x600	105	67881, 67877	38
67885	30x600	105	67881	34

EN Kitchen scale
 PL Waga kuchenna
 DE Küchenwaage
 RU Кухонные весы
 CS Kuchyňská váha
 RO Cantar bucatarie
 HU Konyhamérleg
 ES Báscula de cocina

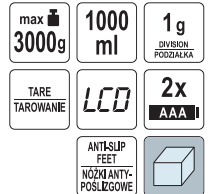

FEATURES:
 - Weight units: oz, g, kg, lb

CECHY:
 - Jednostki wagi: oz, g, kg, lb



LUND

No.	Max. load capacity / Maks. obciążenie [g]	
68360	3000	12



EN Kitchen scale
 PL Waga kuchenna
 DE Küchenwaage
 RU Кухонные весы
 CS Kuchyňská váha
 RO Cantar bucatarie
 HU Konyhamérleg
 ES Báscula de cocina



FEATURES:
 - Weight units: oz, g, kg, lb
 - Scale area: 15 x 17.5 cm

CECHY:
 - Jednostki wagi: oz, g, kg, lb
 - Powierzchnia ważenia: 15 x 17.5 cm



LUND

No.	Max. load capacity / Maks. obciążenie [g]	
68362	5000	12

EN Kitchen scale
 PL Waga kuchenna
 DE Küchenwaage
 RU Кухонные весы
 CS Kuchyňská váha
 RO Cantar bucatarie
 HU Konyhamérleg
 ES Báscula de cocina



FEATURES:
 - Weight units: g, oz
 - Water and milk units: ml, fl oz
 - Removeable jug

CECHY:
 - Jednostki wagi: g, oz
 - Jednostki pomiaru wody, mleka: ml, fl oz
 - Możliwość wyjęcia pojemnika



LUND

No.	Max. load capacity / Maks. obciążenie [g]	
68364	2000	12

EN Cotton candy maker
 PL Urządzenie do waty cukrowej
 DE Zuckerwattemaschine
 RU Сахарная вата кэнди мэйкер
 CS Výrobník cukrové vaty
 RO Aparat de facut vata de zahar
 HU Vattacukor-készítő
 ES Máquina de algodón de azúcar



INCLUDED:
 - 10 sticks
 - Measuring spoon

W ZESTAWIE:
 - 10 patyczków
 - Miarka



LUND

No.	Power / Moc [W]	
68250	450	4

EN Kitchen scale
 PL Waga kuchenna
 DE Küchenwaage
 RU Кухонные весы
 CS Kuchyňská váha
 RO Cantar bucatarie
 HU Konyhamérleg
 ES Báscula de cocina



FEATURES:
 - Weight units: g, kg, ml
 - Scale area: 27 x 22.5 cm

CECHY:
 - Jednostki wagi: g, kg, ml
 - Powierzchnia ważenia: 27 x 22.5 cm



LUND

No.	Max. load capacity / Maks. obciążenie [g]	
68363	5000	12

EN Kitchen scale
 PL Waga kuchenna
 DE Küchenwaage
 RU Кухонные весы
 CS Kuchyňská váha
 RO Cantar bucatarie
 HU Konyhamérleg
 ES Báscula de cocina



FEATURES:
 - Weight units: g, oz
 - Hold function
 - Summary function: max 3000 g

CECHY:
 - Jednostki wagi: g, oz
 - Funkcja utrzymania cyfry na wyświetlaczu
 - Funkcja sumowania: maks. 3000 g



LUND

No.	Max. load capacity / Maks. obciążenie [g]	
68365	300	50

EN Cotton candy maker
 PL Urządzenie do waty cukrowej
 DE Zuckerwattemaschine
 RU Сахарная вата кэнди мэйкер
 CS Výrobník cukrové vaty
 RO Aparat de facut vata de zahar
 HU Vattacukor-készítő
 ES Máquina de algodón de azúcar



INCLUDED:
 - 10 sticks
 - Measuring spoon

W ZESTAWIE:
 - 10 patyczków
 - Miarka



LUND

No.	Power / Moc [W]	
68251	450	8

EN Popcorn maker
 PL Urządzenie do popcornu
 DE Popcorngerät
 RU Аппарат для попкорна
 CS Zařízení k výrobě popcornu
 RO Aparat de făcut popcorn
 HU Popcorn gép
 ES Máquina de palomitas de maíz

220-240V~
50/60Hz

1200
W

ANTI-SLIP
FEET
NOZKI ANTY-
POŚLIZGOWE



FEATURES:
 - Capacity: 50-60 g corn
 - Without oil
 - Ready in 3 min.

CECHY:
 - Pojemność: 50-60 g ziaren
 na cykl
 - Bez użycia oleju
 - Gotowe w 3 min



LUND

No.	Power / Moc [W]	
68260	1200	6

EN Cyclonic vacuum cleaner
 PL Odkurzacz cyklonowy
 DE Zyklonischer Staubsauger
 RU Циклонный пылесос
 CS Cyklonový vysavač
 RO Aspirator ciclonic
 HU Cyclone porszívó
 ES Aspiradora ciclónica

220-240V~
50/60Hz

700
W

1.5L

AUTO-REWIND
BY TOWING THE
CABLE

CYCLONIC
CYKLONOWY

HEPA
H13

BAGLESS
BEZ-
WYKOWY

5m

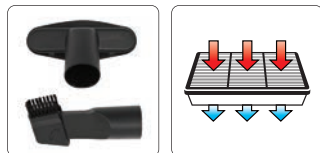
LUND

No.	Power / Moc [W]	
67091	700	1

EN Cyclonic vacuum cleaner
 PL Odkurzacz cyklonowy
 DE Zyklonischer Staubsauger
 RU Циклонный пылесос
 CS Cyklonový vysavač
 RO Aspirator ciclonic
 HU Cyclone porszívó
 ES Aspiradora ciclónica

220-240V~
50/60Hz

700
W

1.5L

AUTO-REWIND
BY TOWING THE
CABLE

CYCLONIC
CYKLONOWY

HEPA
H13

BAGLESS
BEZ-
WYKOWY

5m



LUND

No.	Power / Moc [W]	
67090	700	1

EN Vacuum cleaner filter
 PL Filtr do odkurzacza
 DE Staubsaugerfilter
 RU Фильтр для пылесоса
 CS Filtr vysavače
 RO Filtru aspirator
 HU Porszívó szűrő
 ES Filtro de aspirador

HEPA
H13



LUND

No.	For / Dla	
67093	67090	250

- EN Vacuum cleaner filter
- PL Filtr do odkurzacza
- DE Staubsaugerfilter
- RU Фильтр для пылесоса
- CS Filtr vysavače
- RO Filtru aspirator
- HU Porszívó szűrő
- ES Filtro de aspirador



LUND

No.	For / Dla	
67094	67091, 67092	250

- EN Cyclonic vacuum cleaner
- PL Odkurzacz cyklonowy
- DE Zyklonischer Staubsauger
- RU Циклонный пылесос
- CS Cyklonový vysavač
- RO Aspirator ciclonic
- HU Cyclone porszívó
- ES Aspiradora ciclónica

220-240V-50/60Hz	800 W	1 L
	BAGLESS BEZ-WORKOWY	HEPA H13
4.8 m		



LUND

No.	Power / Moc [W]	
67110	800	4

- EN Vacuum cleaner filter
- PL Filtr do odkurzacza
- DE Staubsaugerfilter
- RU Фильтр для пылесоса
- CS Filtr vysavače
- RO Filtru aspirator
- HU Porszívó szűrő
- ES Filtro de aspirador



LUND

No.	For / Dla	
67095	67090, 67091, 67092	200

- EN Cyclonic vacuum cleaner
- PL Pionowy odkurzacz cyklonowy
- DE Zyklonischer Staubsauger
- RU Циклонный пылесос
- CS Cyklonový vysavač
- RO Aspirator ciclonic
- HU Cyclone porszívó
- ES Aspiradora ciclónica

220-240V-50Hz	800 W	1.5 L	
	BAGLESS BEZ-WORKOWY	HEPA H13	4.8 m



LUND

No.	Power / Moc [W]	
67112	800	4

EN Rechargeable vacuum cleaner
 PL Bezprzewodowy odkurzacz pionowy
 DE Akku-hand Bodenbürstsauger
 RU Перезаряжаемый пылесос
 CS Akumulátorový vysavač
 RO Aspirator reincărcabil
 HU Újratölthető porszívó
 ES Aspiradora recargable

22.2V 2200mAh Li-Ion	120 W	1L
4-5h	25-35 min	CYCLONIC CYKLONOWY
HEPA H13	BAGLESS BEZ- WORKOWY	

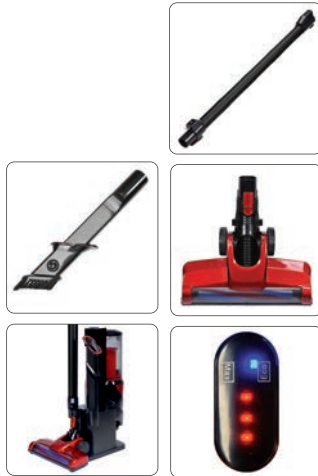

LUND

No.	Power / Moc [W]	
67115	120	4

EN Steam cleaner
 PL Myjka parowa
 DE Dampfreiniger
 RU Паровой очиститель

CS Parní čistič
 RO Curatitor cu aburi
 HU Gőztisztító
 ES Limpiador a vapor

220-240V~ 50/60Hz	900-1050 W	0.3 MPa
400 ml	28-40 g/min	max°C 110
17 ELEMENTS ELEMENT	3m	

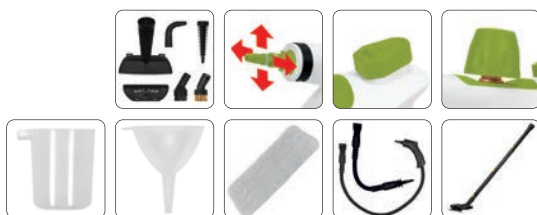

LUND

No.	Power / Moc [W]	
67201	900-1050	4

EN Vacuum cleaner filter
 PL Filtr do odkurzacza
 DE Staubsaugerfilter
 RU Фильтр для пылесоса
 CS Filtr vysavače
 RO Filtru aspirator
 HU Porszívó szűrő
 ES Filtro de aspirador

HEPA
H13



LUND

No.	For / Dla	
67115	67110, 67120	100
67116	67111	200

EN Steam cleaner
 PL Myjka parowa
 DE Dampfreiniger
 RU Паровой очиститель
 CS Parní čistič
 RO Curatitor cu aburi
 HU Gőztisztító
 ES Limpiador a vapor

220-240V~ 50/60Hz	900-1050 W	0.3 MPa	350 ml
28 g/min	max°C 110	10 ELEMENTS ELEMENT	2m



LUND

No.	Power / Moc [W]	
67200	900-1050	6

EN Accessories for steam cleaner
 PL Akcesoria do myjki parowej
 DE Dampfreiniger-Zubehör
 RU Аксессуары для пароочистителя

CS Příslušenství pro parní čistič
 RO Accesorii pt. curatitor cu aburi
 HU Tartozékok gőztisztítóhoz
 ES Accesorios para la limpiadora a vapor

4
PCS

INCLUDED:

- Brass brush
- Bent nozzle
- Round small nylon brush
- Towel microfiber cloth

W ZESTAWIE:

- Szczotka z włosiem z mosiądzu
- Zaokrąglona dysza
- Mała okrągła szczotka
- Mała nakładka z mikrofibry



LUND

No.	For / Dla	pcs / szt.	
67202	67200, 67201	4	200

- EN Tube for steam cleaner
- PL Wąż do myjki parowej
- DE Schlauch für Dampfreiniger
- RU Шланг для парочистителя
- CS Hadice pro parní čistič
- RO Tub pt. curatator cu abur
- HU Tömlő gőztisztítóhoz
- ES Manguera para la limpiadora a vapor

INCLUDED:
- Flexible tube with nozzle

W ZESTAWIE:
- Elastyczny wąż z dyszą



LUND

No.	L [cm]	For / Dla	pcs / szt.
67203	55	67200, 67201	70

- EN Steam mop
- PL Mop parowy
- DE Dampfmop
- RU Паровая швабра
- CS Parní mop
- RO Abur mop
- HU Gőztisztító mop
- ES Trapeador a vapor



220-240V-50/60Hz	1500 W
550 ml	10-26 g/min
max °C 110	14 ELEMENTS ELEMENTY
5m	



LUND

No.	Power / Moc [W]	pcs / szt.
67220	1500	4

- EN Microfiber for steam mop
- PL Mikrofibra do mopa parowego
- DE Mikrofaser-Bezug für Dampfmopp
- RU Микрофибра для паровой швабры
- CS Násada z mikrovlákna na parní mop
- RO Rezerva microfibra pt. mop cu abur
- HU Mikroszálas kendő gőztisztítóhoz
- ES Microfibra para mopa a vapor

3 PCS	MICROFIBER	
--------------	-------------------	--



LUND

No.	For / Dla	pcs / szt.
67222	67220	3
67223	67221	3

- EN Microfibre for steam cleaner
- PL Mikrofibra do myjki parowej
- DE Mikrofaser-Bezug für Dampfreiniger
- RU Микрофибра для парочистителя
- CS Násada z mikrovlákna na parní čistič
- RO Rezerva microfibra pt. curatator cu abur
- HU Mikroszálas kendő gőztisztítóhoz
- ES Microfibra para la limpiadora a vapor

3 PCS	MICROFIBER	
--------------	-------------------	--



LUND

No.	Size / Rozmiar [cm]	For / Dla	pcs / szt.
67204	35x11	67201	3

- EN Steam mop
- PL Mop parowy
- DE Dampfmop
- RU Паровая швабра
- CS Parní mop
- RO Abur mop
- HU Gőztisztító mop
- ES Trapeador a vapor



220-240V-50/60Hz	1500 W	550 ml
10-26 g/min	max °C 110	14 ELEMENTS ELEMENTY
UV LAMP LAMPÁ	5m	



LUND

No.	Power / Moc [W]	pcs / szt.
67221	1500	4

- EN Accessories for steam mop
- PL Akcesoria do mopa parowego
- DE Dampfmopp-Zubehör
- RU Аксессуары для паровой швабры
- CS Příslušenství pro parní mop
- RO Accesorii pt. mop cu abur
- HU Tartozékok gőztisztítóhoz
- ES Accesorios para la mopa a vapor

7 PCS	
--------------	--

INCLUDED:

- Brass brush
- Round small nylon brush
- Round large nylon brush
- Slender brush
- Scrap shovel
- Bent nozzle
- Towel microfiber cloth

W ZESTAWIE:

- Szczotka z włosiem z mosiądzu
- Mała okrągła szczotka
- Duża okrągła szczotka
- Szczotka do fug
- Skrobak
- Zaokrąglona dysza
- Mała nakładka z mikrofibry



LUND

No.	For / Dla	pcs / szt.
67224	67220, 67221	7

EN Tube and jet nozzle for steam mop
 PL Wąż i dysza do mopu parowego
 DE Schlauch und Düse für Dampfmopp
 RU Шланг и насадка для паровой швабры
 CS Hadice a tryska pro parní mop
 RO Tub și duza jet pt. mop cu abur
 HU Tömlő és fúvóka gőzfelmosóhoz
 ES Manguera y boquilla para la mopa a vapor

2 PCS 80 cm



INCLUDED:
 - Flexible tube
 - Jet nozzle

W ZESTAWIE:
 - Elastyczny wąż
 - Długa dysza

LUND

No.	L [cm]	For / Dla	pcs / szt.	
67225	80	67220, 67221	2	50

EN Electric mop
 PL Mop elektryczny
 DE Elektrischer Wischmopp
 RU Электрическая швабра
 CS Elektrický mop
 RO Mop electric
 HU Elektromos felmosó
 ES Mopa eléctrica

7.4 V 2000mAh Li-Ion
 125 min
 3-4h
 60-80 min

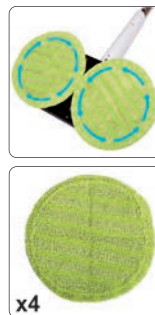

LUND

No.	Battery voltage / Napięcie akumulatora [V d.c.]	
67180	7.4	8

EN Microfiber pads for electric mops
 PL Mikrofibra do mopów elektrycznych
 DE Mikrofaser-Bezug für elektrische Wischmopps
 RU Микрофибра для электрических швабр
 CS Tkanina z mikrovlákna do elektrických mopů
 RO Rezervă microfibră pt. mop electric
 HU Mikroszálás feltét elektromos felmosóhoz
 ES Microfibra para mopa eléctrica

2 PCS MICROFIBER MKROFIBRA



LUND

No.	For / Dla	pcs / szt.	
67181	67180	2	168

EN Electric mop
 PL Mop elektryczny
 DE Elektrischer Wischmopp
 RU Электрическая швабра
 CS Elektrický mop
 RO Mop electric
 HU Elektromos felmosó
 ES Mopa eléctrica

7.4 V 2000mAh Li-Ion
 200 min
 200 ml
 4h
 35-40 min
 LED CHARGE INDICATOR WSKAZNIK NAŁADZIWANIA BATERII
 TELESCOPIC HANDLE UCWYNT TELESKOPOWY

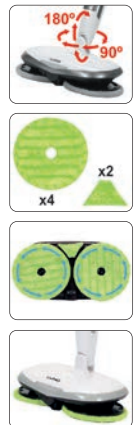

LUND

No.	Battery voltage / Napięcie akumulatora [V d.c.]	
67182	7.4	6

EN Microfiber pads for electric mops
 PL Mikrofibra do mopów elektrycznych
 DE Mikrofaser-Bezug für elektrische Wischmopps
 RU Микрофибра для электрических швабр
 CS Tkanina z mikrovlákna do elektrických mopů
 RO Rezervă microfibră pt. mop electric
 HU Mikroszálás feltét elektromos felmosóhoz
 ES Microfibra para mopa eléctrica

3 PCS MICROFIBER MKROFIBRA



LUND

No.	For / Dla	pcs / szt.	
67183	67182	3	200

EN Travel iron
 PL Żelazko turystyczne
 DE Kompakt-Bügeleisen
 RU Туристический утюг

CS Turistická žehlička
 RO Fier de calcat pt calatorii
 HU Hordozható vasaló
 ES Plancha de viaje

FUNCTIONS:

- Dry
- Steam
- Burst of steam
- Temperature control

FUNKCJE:

- Prasowanie na sucho
- Prasowanie z parą
- Uderzenie pary
- Regulacja temperatury

220-240V- 110-120V- 50-60Hz	1100 W	80 ml
10±3 g/min	CERAMIC SOLEPLATE CERAMICZNA STOPA	2m



LUND

No.	Power / Moc [W]	
68100	1100	10

EN Steam iron
 PL Żelazko parowe
 DE Dampfbügeleisen
 RU Паровой утюг
 CS Napařovací žehlička
 RO Fier de calcat cu abur
 HU Gőzölös vasaló
 ES Plancha de vapor

FUNCTIONS:

- Anti-drip
- Dry
- Spray
- Steam
- Burst of steam
- Vertical steam
- Self-cleaning

- Anti-calcium
- Auto shut off
- Temperature control
- Funkcja samoczyszczenia
- Blokada kapania
- System antywapienny
- Automatyczne wyłączenie
- Regulacja temperatury



LUND

No.	Power / Moc [W]	
68115	2800	10

EN Steam iron
 PL Żelazko parowe
 DE Dampfbügeleisen
 RU Паровой утюг
 CS Napařovací žehlička
 RO Fier de calcat cu abur
 HU Gőzölös vasaló
 ES Plancha de vapor

FUNCTIONS:

- Dry
- Spray
- Steam
- Burst of steam
- Vertical steam
- Self-cleaning
- Anti-drip
- Anti-calcium
- Auto shut off
- Temperature control

FUNKCJE:

- Prasowanie na sucho
- Spryskiwacz
- Prasowanie z parą
- Uderzenie pary
- Pionowy wyrzut pary
- Funkcja samoczyszczenia
- Blokada kapania
- System antywapienny
- Automatyczne wyłączenie
- Regulacja temperatury

220-240V- 50-60Hz	2800 W	300 ml	25 g/min
22.5x11.5 cm	CERAMIC SOLEPLATE CERAMICZNA STOPA	2m 	



LUND

No.	Power / Moc [W]	
68116	2400-2800	10

EN Garment steamer
 PL Parownica do ubrań
 DE Dampfglätter
 RU Отпариватель для одежды
 CS Oděv parník
 RO Aparat de calcat vertical
 HU Ruha gőztisztító
 ES Vapor de la ropa

220-240V- 50-60Hz	600 W	100 ml	16 g/min
23.5x12.5 cm	CERAMIC SOLEPLATE CERAMICZNA STOPA	2m 	
max °C 110		1.8m 	



LUND

No.	Power / Moc [W]	
67231	600	12

20

EN Garment steamer
 PL Parownica do ubrań
 DE Dampfglätter
 RU Отпариватель для одежды
 CS Oděv parník
 RO Aparat de calcat vertical
 HU Ruha gőztisztító
 ES Vapor de la ropa

220-240V- 50-60Hz	1100 W	100 ml	10 g/min
13x7.5 cm	CERAMIC SOLEPLATE CERAMICZNA STOPA	2m 	



LUND

No.	Power / Moc [W]	
68090	900-1100	10

EN Aroma diffuser
 PL Dyfuzor zapachu
 DE Aroma-Diffusor
 RU Диффузор запаха
 CS Difuzér vůně
 RO Difuzer parfum
 HU Illatdiffúzor
 ES Difusor de fragancias

5W 100 ml 15 ml/h 7 COLOURS KOLORŮ
 15 m² 3 h



FEATURES:
 - Work type: ultrasounds
CECHY:
 - Rodzaj pracy: ultradźwięki



LUND

No.	Power / Moc [W]	
66900	5	36

EN Aroma diffuser
 PL Dyfuzor zapachu
 DE Aroma-Diffusor
 RU Диффузор запаха
 CS Difuzér vůně
 RO Difuzer parfum
 HU Illatdiffúzor
 ES Difusor de fragancias

12 W 500 ml 40-60 ml/h 7 COLOURS KOLORŮ
 50 m² 1h 3h 6h



FEATURES:
 - Work type: ultrasounds
 - Mist type: low, high
CECHY:
 - Rodzaj pracy: ultradźwięki
 - Rodzaje mgiełki: niska, wysoka



LUND

No.	Power / Moc [W]	
66902	12	12

EN Aroma diffuser
 PL Dyfuzor zapachu
 DE Aroma-Diffusor
 RU Диффузор запаха
 CS Difuzér vůně
 RO Difuzer parfum
 HU Illatdiffúzor
 ES Difusor de fragancias

12 W 500 ml 40-60 ml/h 7 COLOURS KOLORŮ
 50 m² 2h 4h



FEATURES:
 - Work type: ultrasounds
 - Mist type: low, high
CECHY:
 - Rodzaj pracy: ultradźwięki
 - Rodzaje mgiełki: niska, wysoka



LUND

No.	Power / Moc [W]	
66904	12	12

EN Aroma diffuser
 PL Dyfuzor zapachu
 DE Aroma-Diffusor
 RU Диффузор запаха
 CS Difuzér vůně
 RO Difuzer parfum
 HU Illatdiffúzor
 ES Difusor de fragancias

12 W 120 ml 30 ml/h 7 COLOURS KOLORŮ
 20 m² 2 h



FEATURES:
 - Work type: ultrasounds
 - Mist type: low, high
CECHY:
 - Rodzaj pracy: ultradźwięki
 - Rodzaje mgiełki: niska, wysoka



LUND

No.	Power / Moc [W]	
66901	12	24

EN Aroma diffuser
 PL Dyfuzor zapachu
 DE Aroma-Diffusor
 RU Диффузор запаха
 CS Difuzér vůně
 RO Difuzer parfum
 HU Illatdiffúzor
 ES Difusor de fragancias

12 W 500 ml 40-60 ml/h 7 COLOURS KOLORŮ
 50 m² 1h 3h 6h



FEATURES:
 - Work type: ultrasounds
 - Mist type: low, high
CECHY:
 - Rodzaj pracy: ultradźwięki
 - Rodzaje mgiełki: niska, wysoka



LUND

No.	Power / Moc [W]	
66903	12	12

EN Aroma diffuser
 PL Dyfuzor zapachu
 DE Aroma-Diffusor
 RU Диффузор запаха
 CS Difuzér vůně
 RO Difuzer parfum
 HU Illatdiffúzor
 ES Difusor de fragancias

13 W 1000 ml 50-70 ml/h 7 COLOURS KOLORŮ
 50 m² 3h 6h 9h



FEATURES:
 - Work type: ultrasounds
 - Mist type: low, high
CECHY:
 - Rodzaj pracy: ultradźwięki
 - Rodzaje mgiełki: niska, wysoka



LUND

No.	Power / Moc [W]	
66906	13	12

EN Air purifier
 PL Oczyszczacz powietrza
 DE Luftreiniger
 RU Очиститель воздуха
 CS Čistička vzduchu
 RO Purificator aer
 HU Légtisztító
 ES Purificador de aire

220-240V~ 50/60Hz	40 W	PM 2.5	220 m ³ /h CADR
HEPA H10	8h	20-35 m ²	8mln
2m			

FEATURES:

- 4 stages of air purification: polypropylene pre filter, HEPA H10, carbon filter, ionizer
- 3 levels of purification speed
- Sleep mode
- Smart mode
- PM 2.5 detection
- CADR 220 m³/h (Clean Air Delivery Rate for particulate matter PM 2.5)
- Temperature detection and indicator
- Odor sensor
- Filter replace reminder

CECHY:

- 4 etapy oczyszczania: filtr wstępny z polipropylenu, filtr HEPA H10, filtr węglowy, jonizator
- 3 prędkości oczyszczania
- Tryb uśpienia
- Tryb automatyczny
- Czujnik pyłu PM 2.5
- CADR 220 m³/h (szybkość dostarczania czystego powietrza dla cząstek stałych PM 2.5)
- Czujnik i wskaźnik temperatury
- Czujnik zapachu
- Funkcja przypomnienia o wymianie filtra



No.	Power / Moc [W]	
66930	40	1

EN Air purifier
 PL Oczyszczacz powietrza
 DE Luftreiniger
 RU Очиститель воздуха
 CS Čistička vzduchu
 RO Purificator aer
 HU Légtisztító
 ES Purificador de aire

220-240V~ 50/60Hz	55 W	PM 2.5	330 m ³ /h CADR	HEPA H12
UV LAMP LAMP	8h		50-70 m ²	8mln
2m				

FEATURES:

- 6 stages of air purification: aluminum mesh, UV lamp, HEPA H12, carbon filter, photocatalysis, ionizer
- Built-in air humidifier
- 4 levels of purification speed
- Sleep mode
- Smart mode
- PM 2.5 detection
- CADR 330 m³/h (Clean Air Delivery Rate for particulate matter PM 2.5)
- CADR 68 m³/h (Clean Air Delivery Rate for formaldehyde)
- Temperature detection and indicator
- Humidity detection and indicator
- Odor sensor
- Filter replace reminder
- Safety kid lock

CECHY:

- 6 etapów oczyszczania: filtr wstępny - aluminiowa siatka, lampka UV, filtr HEPA H12, filtr węglowy, filtr fotokatalizacyjny, jonizator
- Wbudowany nawilżacz powietrza
- 4 prędkości oczyszczania
- Tryb uśpienia
- Tryb automatyczny
- Czujnik pyłu PM 2.5
- CADR 330 m³/h (szybkość dostarczania czystego powietrza dla cząstek stałych PM 2.5)
- CADR 68 m³/h (szybkość dostarczania czystego powietrza dla formaldehydu)
- Czujnik i wskaźnik temperatury
- Czujnik i wskaźnik poziomu wilgotności
- Czujnik zapachu
- Funkcja przypomnienia o wymianie filtra
- Blokada rodzicielska



No.	Power / Moc [W]	
66936	55	1

EN Air purifier
 PL Oczyszczacz powietrza
 DE Luftreiniger
 RU Очиститель воздуха
 CS Čistička vzduchu
 RO Purificator aer
 HU Légtisztító
 ES Purificador de aire

220-240V~ 50/60Hz	65 W	PM 2.5	420 m ³ /h CADR	HEPA H12	8h
50-70 m ²		5mln		2m	

FEATURES:

- 7 stages of air purification: aluminum mesh, HEPA H12, carbon filter, photocatalysis, UV lamp, cold catalyst, ionizer
- 3 levels of purification speed
- Sleep mode
- Smart mode
- PM 2.5 detection
- CADR 420 m³/h (Clean Air Delivery Rate for particulate matter PM 2.5)
- CADR 68 m³/h (Clean Air Delivery Rate for formaldehyde)
- Temperature detection and indicator
- Humidity detection and indicator
- Odor sensor
- Filter replace reminder
- Safety kid lock

CECHY:

- 7 etapów oczyszczania: filtr wstępny - aluminiowa siatka, filtr HEPA H12, filtr węglowy, filtr fotokatalizacyjny, lampka UV, zimny filtr katalizacyjny, jonizator
- 3 prędkości oczyszczania
- Tryb uśpienia
- Tryb automatyczny
- Czujnik pyłu PM 2.5
- CADR 420 m³/h (szybkość dostarczania czystego powietrza dla cząstek stałych PM 2.5)
- CADR 68 m³/h (szybkość dostarczania czystego powietrza dla formaldehydu)
- Czujnik i wskaźnik temperatury
- Czujnik i wskaźnik poziomu wilgotności
- Czujnik zapachu
- Funkcja przypomnienia o wymianie filtra
- Blokada rodzicielska



No.	Power / Moc [W]	
66932	65	1

EN Air purifier filter
 PL Filtr do oczyszczacza powietrza
 DE Filter für Luftreiniger
 RU Фильтр для очистки воздуха
 CS Filtr do čističky vzduchu
 RO Filtru pt. purificator aer
 HU Légtisztító szűrő
 ES Filtro para purificador de aire

3 in 1	
3 w 1	

TYPE OF FILTERS:

- Polypropylene pre-filter
- HEPA H10
- Carbon filter

TYPY FILTRÓW:

- Filtr wstępny z polipropylenu
- HEPA H10
- Filtr węglowy

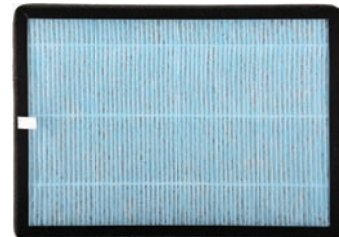

LUND

No.	For / Dla	
66931	66930	40

EN Air purifier filter
 PL Filtr do oczyszczacza powietrza
 DE Filter für Luftreiniger
 RU Фильтр для очистки воздуха
 CS Filtr do čističky vzduchu
 RO Filtru pt. purificator aer
 HU Légtisztító szűrő
 ES Filtro para purificador de aire

5 in 1	
5 w 1	

TYPE OF FILTERS:

- Aluminium mesh
- HEPA H12
- Carbon filter
- Photocatalysis
- Cold catalyst

TYPY FILTRÓW:

- Aluminiowa siatka
- HEPA H12
- Filtr węglowy
- Fotokatalizacyjny
- Zimny filtr katalizacyjny

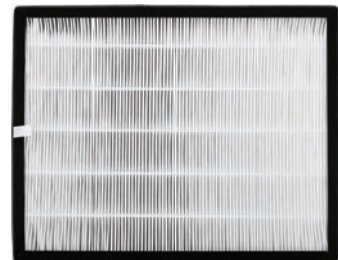

No.	For / Dla	
66933	66932	30

EN Air purifier filter
 PL Filtr do oczyszczacza powietrza
 DE Filter für Luftreiniger
 RU Фильтр для очистки воздуха
 CS Filtr do čističky vzduchu
 RO Filtru pt. purificator aer
 HU Légtisztító szűrő
 ES Filtro para purificador de aire



TYPE OF FILTERS:

- Aluminium mesh
- HEPA H12
- Carbon filter
- Photocatalysis

TYPY FILTRÓW:

- Aluminiowa siatka
- HEPA H12
- Filtr węglowy
- Filtr fotokatalityczny

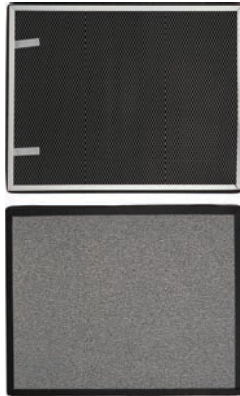

LUND

No.	For / Dla	
66937	66934, 66936	20

EN Ozone generator
 PL Generator ozonu
 DE Ozon-Generator
 RU Генератор озона
 CS Generátor ozónu
 RO Generator ozon
 HU Ozongenerátor
 ES Generador de ozono

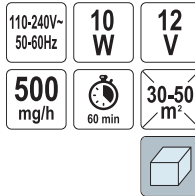

LUND

No.	Power / Moc [W]	
66950	10	10

EN Diffuser for ozone generator
 PL Dyfuzor do generatora ozonu
 DE Diffusur zum Ozon-Generator
 RU Диффузор для генератора озона
 CS Difuzér do generátoru ozónu
 RO Difuzor pt. generatorul de ozon
 HU Diffúzor ózongenerátorhoz
 ES Difusor de generador de ozono

LUND

No.	For / Dla	
66956	66940, 66950	100

EN Air purifier with ozon generator
 PL Oczyszczacz powietrza z generatorem ozonu
 DE Luftreinigungsgerät mit Ozon-Generator
 RU Очиститель воздуха с генератором озона
 CS Čistička vzduchu s generátorem ozónu
 RO Purificator aer cu generator de ozon
 HU Légtisztító ózongenerátorral
 ES Purificador de aire con generador de ozono



FEATURES:

- 5 stages of air purification: HEPA H13, carbon filter, photocatalysis, UV lamp, ionizer
- Ozone maker
- Filter replace reminder
- Air purifier - timer 1-12 h
- Ozonator - timer 60 min

CECHY:

- 5 etapów oczyszczania: filtr HEPA H13, filtr węglowy, filtr fotokatalityczny, lampa UV, jonizator
- Generator ozonu
- Funkcja przypominania o wymianie filtra
- Oczyszczacz powietrza - czasomierz 1-12 h
- Ozonator - czasomierz 60 min



LUND

No.	Power / Moc [W]	
66940	10	6

EN Air purifier filter
 PL Filtr do oczyszczacza powietrza
 DE Filter für Luftreiniger
 RU Фильтр для очистки воздуха
 CS Filtr do čističky vzduchu
 RO Filtru pt. purificator aer
 HU Légtisztító szűrő
 ES Filtro para purificador de aire

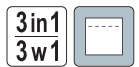

LUND

No.	For / Dla	
66955	66940	100









21

Household equipment
Gospodarstwo domowe



Mailboxes Skrzynki na listy	
.....	348-349
Coal stoves accessories Akcesoria do piecy węglowych	
.....	349-352
Brushes Szcotki	
.....	352-357
Mops Zgarniacze do wody	
.....	357
Multipurpose trays Podstawki gospodarcze	
.....	357
Bags Worki	
.....	357-360
Tarpaulins & accessories Plandeki i akcesoria	
.....	360-361
Vacuum cleaners, ash separators & accessories Odkurzacze, separatory popiołu i akcesoria	
.....	361-364
Syphon pumps Pompy syfonowe	
.....	364
Pumps Pompki	
.....	364

Hydraulic accessories Akcesoria hydrauliczne	
.....	364
Vaselines Wazeliny techniczne	
.....	365
Hand trucks Wózki magazynowe	
.....	365
Floor conveyors Transport poziomy	
.....	366
Casters Kółka	
.....	366-368
Seals Uszczelnienia	
.....	369
Self-adhesive furniture pads Podkładki samoprzylepne pod meble	
.....	369-372
Plastic stools Stołki plastikowe	
.....	372
Hooks & furniture protection Haczyki i zabezpieczenia	
.....	372-375

EN Mailbox
 PL Skrzynka na listy
 DE Briefkasten
 RU Почтовый ящик
 CS Schránka na dopisy
 RO Cutie poştală
 HU Levélláda
 ES Buzón



No.	Dimensions / Wymiary [mm]	Slot width / Szerokość wrzutu [mm]	Color / Kolor	
78540	285x200x60	143	czarny	12
78541	285x200x60	143	grafitowy	12
78542	285x200x60	143	brązowy	12
78543	285x200x60	143	zielony	12

EN Mailbox
 PL Skrzynka na listy
 DE Briefkasten
 RU Почтовый ящик
 CS Schránka na dopisy
 RO Cutie poştală
 HU Levélláda
 ES Buzón



No.	Dimensions / Wymiary [mm]	Slot width / Szerokość wrzutu [mm]	Color / Kolor	
78570	400x250x100	230	czarny	6
78571	400x250x100	230	grafitowy	6
78572	400x250x100	230	brązowy	6

EN Mailbox
 PL Skrzynka na listy
 DE Briefkasten
 RU Почтовый ящик
 CS Schránka na dopisy
 RO Cutie poştală
 HU Levélláda
 ES Buzón



No.	Dimensions / Wymiary [mm]	Slot width / Szerokość wrzutu [mm]	Color / Kolor	
78580	380x320x105	220	czarny	5
78581	380x320x105	220	grafitowy	5
78582	380x320x105	220	brązowy	5

EN Mailbox
 PL Skrzynka na listy
 DE Briefkasten
 RU Почтовый ящик
 CS Schránka na dopisy
 RO Cutie poştală
 HU Levélláda
 ES Buzón



No.	Dimensions / Wymiary [mm]	Slot width / Szerokość wrzutu [mm]	Color / Kolor	
78555	360x260x80	220	czarny	6
78556	360x260x80	220	grafitowy	6
78557	360x260x80	220	brązowy	6

EN Mailbox
 PL Skrzynka na listy
 DE Briefkasten
 RU Почтовый ящик
 CS Schránka na dopisy
 RO Cutie poştală
 HU Levélláda
 ES Buzón



No.	Dimensions / Wymiary [mm]	Slot width / Szerokość wrzutu [mm]	Color / Kolor	
78575	310x360x100	320	czarny	6
78576	310x360x100	320	grafitowy	6
78577	310x360x100	320	brązowy	6

EN Mailbox
 PL Skrzynka na listy
 DE Briefkasten
 RU Почтовый ящик
 CS Schránka na dopisy
 RO Cutie poştală
 HU Levélláda
 ES Buzón



No.	Dimensions / Wymiary [mm]	Slot width / Szerokość wrzutu [mm]	Color / Kolor	
78585	380x320x105	220	czarny	5
78586	380x320x105	220	grafitowy	5
78587	380x320x105	220	brązowy	5

EN Mailbox
 PL Skrzynka na listy
 DE Briefkasten
 RU Почтовый ящик
 CS Schránka na dopisy
 RO Cutie poștală
 HU Levélláda
 ES Buzón



VOREL

No.	Dimensions / Wymiary [mm]	Slot width / Szerokość wrzutu [mm]	Color / Kolor	
78590	480x280x80	198	czarny	5
78591	480x280x80	198	grafitowy	5
78592	480x280x80	198	brązowy	5

EN Hanging fireplace tool set
 PL Zestaw kominkowy wiszący
 DE Hängendes Kaminset
 RU Набор каминный подвесной
 CS Krbové nářadí na zeď
 RO Set unelte șemineu agatat
 HU Kandalló tisztító készlet függő
 ES Herramientas de chimenea colgante

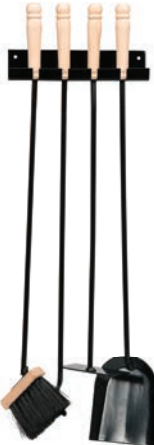

VOREL

No.	pcs / szt.	
72973	4	1

EN Painted stove metal plate
 PL Blacha przypieczowa malowana
 DE Brennblech, mit Farbenstrich
 RU Оцинкованный окрашенный лист для обшивки печи
 CS Podložka pod pec z lakovaného plechu
 RO Tablă sobă vopsită
 HU Festett hő terelő lemez kályhához
 ES Chapa pintada para estufa



VOREL

No.	Size / Rozmiar [mm]	Thickness / Grubość [mm]	
72936	476x603	0.5	10
72937	476x800	0.5	10

EN Standing fireplace tool set
 PL Zestaw kominkowy stojący
 DE Stehendes Kaminset
 RU Набор каминный стоячий
 CS Krbové nářadí se stojánkem
 RO Stand unelte șemineu
 HU Kandalló tisztító készlet állván
 ES Herramientas de chimenea con soporte

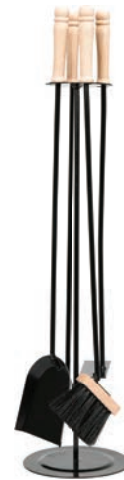

VOREL

No.	pcs / szt.	
72972	4	1

EN Galvanized stove metal plate
 PL Blacha przypieczowa ocynkowana
 DE Brennblech, verzinkt
 RU Оцинкованный лист для обшивки печи
 CS Podložka pod pec z pozinkovaného plechu
 RO Tablă sobă zincată
 HU Galvanizált hő terelő lemez kályhához
 ES Chapa galvanizada para estufa



VOREL

No.	Size / Rozmiar [mm]	Thickness / Grubość [mm]	
72933	305x475	0.5	10
72934	396x600	0.5	10
72935	485x663	0.5	10

EN Chimney brush
 PL Przetykacz do wyczystki kominowej
 DE Kaminbürste
 RU Щетка для дымохода
 CS Kominový kartáč
 RO Coș de perie
 HU Kéménykefe
 ES Brosse de cheminée



VOREL

No.	Brush diameter / Średnica wyciora [mm]	
72955	150	20

- EN Chimney cleaner
- PL Wycior kominowy
- DE Schornsteinreiniger
- RU Щетка для трубочистов
- CS Kartáč kominový
- RO Racletă pt. coșul de fum
- HU Kéménytisztító kefe
- ES Arilla para baquetas de calefacción central



No.	Ø [mm]	
72948	120	15
72950	150	20
72951	175	18
72952	200	18

- EN Chimney cleaner
- PL Wycior kominowy
- DE Schornsteinreiniger
- RU Щетка для трубочистов
- CS Kartáč kominový
- RO Racletă pt. coșul de fum
- HU Kéménytisztító kefe
- ES Arilla para baquetas de calefacción central



VOREL

No.	Ø [mm]	
72994	120	15
72995	150	20
72996	175	18
72997	200	18
72998	250	12

- EN Chimneysweep ball
- PL Kula kominarska stalowa
- DE Zuggewicht aus Stahl
- RU Шар дымоходный для чистки дымоходов
- CS Kominová koule
- RO Acél öntvény kéménygolyó
- HU Bila curatat cos de fum
- ES Bola de chimenea de acero



VOREL

No.	m [kg]	
73025	1.3	5
73026	1.8	5
73027	2.5	5

- EN Chimney cleaner
- PL Wycior kominowy
- DE Schornsteinreiniger
- RU Щетка для трубочистов
- CS Kartáč kominový
- RO Racletă pt. coșul de fum
- HU Kéménytisztító kefe
- ES Arilla para baquetas de calefacción central



VOREL

No.	Ø [mm]	
72953	250	12
72954	300	8

- EN Chimney rope
- PL Lina kominarska
- DE Schornsteinfeger-Seil
- RU Трос для чистки дымоходов
- CS Kominové lano
- RO Franghie pt. cos de fum
- HU Kémény kötél
- ES Cuerda de chimenea



VOREL

No.	Ø [mm]	L [m]	
73021	6	10	15
73022	8	10	15

- EN Iron chimneysweep ball
- PL Kula kominarska żelazna
- DE Schornsteinfegerkugel
- RU Гиря для трубочистов
- CS Kaminikrečio kameuolys
- RO Bilă pt. coșul de fum
- HU Kémény golyó
- ES Esfera del dehornador



No.	m [kg]	
72938	15	4
72939	25	4

EN Chimney brush with iron ball
 PL Zestaw kominarski
 DE Schornsteinfeger-Garnitur; Zuggewicht Russbesen Seil
 RU Набор для чистки дымохода

CS Kominový set
 RO Perie cos cu bila + franghie
 HU Kéménytisztító szettek
 ES Redondo limpieza cepillo bola de acero



VOREL

No.	Brush diameter / Średnica wyciora [mm]	Ball weight / Masa kuli [kg]	Rope length / Długość liny [m]	
73031	125	1.3	10	1
73032	150	1.3	10	1
73033	175	1.8	10	1
73034	200	1.8	10	1
73035	250	2.5	10	1

EN Chimney wire
 PL Drut kominowy
 DE Schornsteindraht
 RU Проволока для трубочистов
 CS Kamínkréčio trosas
 RO Sărmă pt. coșul de fum
 HU Kéménytisztító drót
 ES Alambre de chimeneas



No.	Ø [mm]	L [m]	
72942	3.5	6	25
72943	3.5	8	20
72944	3.5	10	20
72945	3.5	12	20

EN Shovel
 PL Szufelka angielska
 DE Schaufel
 RU Совок
 CS Lopatka
 RO Lopățică
 HU Lapát
 ES Pala



No.	W [mm]	L [mm]	
72974	340	200	18

EN Central heating cleaning rod
 PL Pręt do wyciorów
 DE Stab für die Reiniger der Zentralheizung
 RU Черенок для щеток – центральное отопление
 CS Tyč k čištění
 RO Tije pt. racleți încălzire centrală
 HU CO pálcá a fűcsőtisztító keféhez
 ES Baqueta para limpiar el sistema de calefacción central



No.	Ø [mm]	L [mm]	
72956	7	600	50
72958	7	800	50
72960	7	1000	50

EN Chimney cleaner
 PL Wycior do C.O.
 DE Schornsteinreiniger
 RU Щетка для трубочистов
 CS Kartáč kominový
 RO Racletă pt. coșul de fum
 HU Kéménytisztító kefe
 ES Arilla para baquetas de calefacción central



No.	Ø [mm]	
72963	30	50
72964	40	50
72965	50	50
72966	60	35
72967	70	35
72968	80	30
72969	90	20
72970	100	20

EN Shovel
 PL Szufelka gospodarcza
 DE Schaufel
 RU Совок
 CS Lopatka
 RO Lopățică
 HU Lapát
 ES Pala



VOREL

No.	W [mm]	L [mm]	
72976	220	380	20

EN Poker
 PL Pogrzebacz
 DE Schürreisen
 RU Кочерга
 CS Pohrabáč
 RO Vătrași
 HU Piszkavás
 ES Hurgón



No.	L [mm]	
72981	620	50

EN Shovel
 PL Szufelka
 DE Schaufel
 RU Совок
 CS Lopatka
 RO Lopățică
 HU Lapát
 ES Pala



No.	W [mm]	L [mm]	
72978	140	490	40
72977	180	550	30

EN Coal carrier
 PL Węglarka duża
 DE Kohlenkasten
 RU Ведро для угля
 CS Uhlák
 RO Rezervor de cărbuni pt. sobă
 HU Szeneskosár
 ES Carbonera



No.	W [mm]	H [mm]	L [mm]	
72984	210	125	385	5

EN Coal carrier
 PL Węglarka mała
 DE Kohlenkasten
 RU Ведро для угля
 CS Uhlák
 RO Rezervor de cărbuni pt. sobă
 HU Szeneskosár
 ES Carbonera



No.	W [mm]	H [mm]	L [mm]	
72985	200	175	370	5

EN Shovel
 PL Szufelka szeroka
 DE Schaufel
 RU Совок
 CS Lopatka
 RO Lopățică
 HU Lapát
 ES Pala



No.	W [mm]	L [mm]	
72975	220	460	40

EN Shovel
 PL Szufelka mała
 DE Schaufel
 RU Совок
 CS Lopatka
 RO Lopățică
 HU Lapát
 ES Pala



No.	W [mm]	L [mm]	
72979	110	500	5/30

EN Microfiber spray mop and window wiper
 PL Mop ze spryskiwaczem z myjką do okien
 DE Spritz Mop
 RU Спрей швабра
 CS Stříkací mop
 RO Mop cu pulverizator
 HU Permetező mop
 ES Rociar fregona

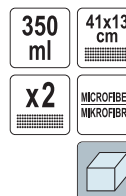

FEATURES:
 - For every type of surface: wood, floor panel, tile, stone, PVC
 - Multidirectional mop head

CECHY:
 - Do każdego rodzaju powierzchni: drewna, paneli podłogowych, płytek, kamienia, PCV
 - Wielokierunkowa stopa czyszcząca



LUND

No.	
67160	12

EN Double-sided microfiber spray mop
 PL Dwustronny mop ze spryskiwaczem
 DE Spritz Mop
 RU Спрей швабра
 CS Stříkací mop
 RO Mop cu pulverizator
 HU Permetező mop
 ES Rocíar fregona

FEATURES:

- Wet & dry cleaning
- For every type of surface: wood, floor panel, tile, stone, PVC
- Multidirectional mop head

CECHY:

- Mycie na mokro i na sucho
- Do każdego rodzaju powierzchni: drewna, paneli podłogowych, płytek, kamienia, PCV
- Wielokierunkowa stopa czyszcząca

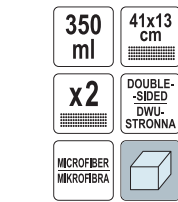

LUND

No.	Image
67161	

EN Microfiber
 PL Mikrofibra
 DE Mikrofaser
 RU Микроволокно

CS Mikrovlákno
 RO Microfibră
 HU Mikroszálás
 ES Microfibra



LUND

No.	Size / Rozmiar [mm]	For / Dla	Image
67164	410x130	67161	

EN Microfiber
 PL Mikrofibra
 DE Mikrofaser
 RU Микроволокно

CS Mikrovlákno
 RO Microfibră
 HU Mikroszálás
 ES Microfibra



LUND

No.	Size / Rozmiar [mm]	For / Dla	Image
67166	280x70	67162	

EN Microfiber spray mop and window wiper
 PL Mop ze spryskiwaczem z myjką do okien
 DE Spritz Mop
 RU Спрей швабра
 CS Stříkací mop
 RO Mop cu pulverizator
 HU Permetező mop
 ES Rocíar fregona

FEATURES:

- For every type of surface: wood, floor panel, tile, stone, PVC
- Multidirectional mop head

CECHY:

- Do każdego rodzaju powierzchni: drewna, paneli podłogowych, płytek, kamienia, PCV
- Wielokierunkowa stopa czyszcząca

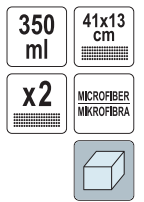

LUND

No.	Image
67162	

EN Microfiber
 PL Mikrofibra
 DE Mikrofaser
 RU Микроволокно

CS Mikrovlákno
 RO Microfibră
 HU Mikroszálás
 ES Microfibra



LUND

No.	Size / Rozmiar [mm]	For / Dla	Image
67165	410x130	67160, 67162	

EN Floor sweeper
 PL Szczotka obrotowa
 DE Boden sweeper
 RU Турбо-щётка
 CS Mechanický zametač
 RO Podea peria
 HU Forgó keféс
 ES Barredora de escoba

FEATURES:

- Great for pet hair
- Capacious basket
- For every type of surface: wood, floor panel, tile, stone, PVC

CECHY:

- Odpowiednia do sierści zwierząt
- Pojemny kosz
- Do każdego rodzaju powierzchni: drewna, paneli podłogowych, płytek, kamienia, PCV



LUND

No.	Image
67163	

EN Broom
 PL Zamiatacz
 DE Feger
 RU Подметальная машина
 CS Smeták
 RO Matura
 HU Seprűfej
 ES Barredor



No.	Working width / Szerokość robocza [mm]	
35930	300	10

EN Broom with handle
 PL Zamiatacz z trzonkiem
 DE Feger mit Stiel
 RU Подметальная машина с ручкой
 CS Smeták s násadou
 RO Matura cu coada
 HU Seprű nyélel
 ES Barredor con mango



No.	Working width / Szerokość robocza [mm]	L [mm]	
35931	300	1180	12

EN Broom
 PL Zamiatacz
 DE Feger
 RU Подметальная машина
 CS Smeták
 RO Matura
 HU Seprűfej
 ES Barredor



No.	Working width / Szerokość robocza [mm]	
35932	270	18

EN Broom
 PL Zamiatacz z odbojnikiem
 DE Feger mit Puffer
 RU Подметальная машина с бампером
 CS Smeták s chrániči
 RO Matura cu protectie
 HU Seprűfej ütközővel
 ES Barredor con tope



No.	Working width / Szerokość robocza [mm]	
35933	290	18

EN Brush
 PL Zmiotka ręczna
 DE Handfeger
 RU Ручная щетка-веник
 CS Smetáček
 RO Perie cu maner
 HU Kézi seprű
 ES Escoba manual



No.	Working width / Szerokość robocza [mm]	
35940	290	25

EN Scrubbing brush
 PL Szczotka do szorowania
 DE Scheuerbürste
 RU Щетка для чистки
 CS Rýžový kartáč
 RO Perie pt. curatat
 HU Súrolókefe
 ES Cepillo para frotar



No.	Working width / Szerokość robocza [mm]	
35960	195	70

EN Scrubbing brush
 PL Szczotka do szorowania
 DE Scheuerbürste
 RU Щетка для чистки
 CS Rýžový kartáč
 RO Perie pt. curatat
 HU Súrolókefe
 ES Cepillo para frotar



No.	Working width / Szerokość robocza [mm]	
35961	195	70

EN Scrubbing brush
 PL Szczotka do szorowania
 DE Scheuerbürste
 RU Щетка для чистки
 CS Rýžový kartáč
 RO Perie pt. curatat
 HU Súrolókefe
 ES Cepillo para frotar



No.	Working width / Szerokość robocza [mm]	
35962	230	20

EN Scrubbing brush
 PL Szczotka do szorowania
 DE Scheuerbürste
 RU Щетка для чистки
 CS Rýžový kartáč
 RO Perie pt. curatat
 HU Súrolókefe
 ES Cepillo para frotar



VOREL

No.	Working width / Szerokość robocza [mm]	
35963	300	10

EN Scrubbing brush with a handle
 PL Szczotka z trzonkiem
 DE Bürste mit Stiel
 RU Щетка с черенком
 CS Kartáč s násadou
 RO Perie pt. curatat cu maner
 HU Kéfe nyéllel
 ES Cepillo con mango



VOREL

No.	Working width / Szerokość robocza [mm]	L [mm]	
35968	300	1240	10

EN Hand scrub brush
 PL Szczotka ręczna
 DE Handbürste
 RU Ручная щетка
 CS Ruční kartáč
 RO Perie de mana pt. curatat
 HU Kézi kefe
 ES Cepillo manual



VOREL

No.	Working width / Szerokość robocza [mm]	
35971	200	10

EN Broom
 PL Miotła
 DE Strassenbesen
 RU Метла

CS Metla
 RO Matura
 HU Partvis
 ES Cepillo pelo largo



No.		
35869		10

EN Scrubbing brush
 PL Szczotka do szorowania
 DE Scheuerbürste
 RU Щетка для чистки
 CS Rýžový kartáč
 RO Perie pt. curatat
 HU Súrolókefe
 ES Cepillo para frotar



VOREL

No.	Working width / Szerokość robocza [mm]	
35964	300	10

EN Hand scrub brush
 PL Szczotka ręczna
 DE Handbürste
 RU Ручная щетка
 CS Ruční kartáč
 RO Perie de mana pt. curatat
 HU Kézi kefe
 ES Cepillo manual



VOREL

No.	Working width / Szerokość robocza [mm]	
35970	200	10

EN Broom
 PL Miotła
 DE Strassenbesen
 RU Метла

CS Metla
 RO Matura
 HU Partvis
 ES Cepillo pelo largo



No.	Working width / Szerokość robocza [mm]	
35867	300	10
35868	400	10

EN Broom
 PL Miotła
 DE Strassenbesen
 RU Метла
 CS Metla
 RO Matura
 HU Partvis
 ES Cepillo pelo largo



No.	Working width / Szerokość robocza [mm]	
35870	300	10
35872	400	10
35874	500	10
35875	600	10
35876	800	10
35877	1000	10

EN Broom
 PL Miotła
 DE Strassenbesen
 RU Метла
 CS Metla
 RO Matura
 HU Partvis
 ES Cepillo pelo largo



No.	Working width / Szerokość robocza [mm]	
35914	400	10
35915	500	10
35916	600	10
35918	800	10

EN Broom
 PL Miotła drucziana do bruku
 DE Strassenbesen
 RU Метла
 CS Metla
 RO Matura
 HU Partvis
 ES Cepillo pelo largo



No.	Working width / Szerokość robocza [mm]	
35923	300	6
35924	400	6

EN Wire paving brush
 PL Szczotka do bruku z radełkiem
 DE Bürste mit Schaber für Reinigung von Pflastersteinen
 RU Щетка для тротуарной плитки с шилом
 CS Kartáč do dlažby s ráčlíkem
 RO Perie din sarma pt pavaj
 HU Járdakefé pengével
 ES Cepillo para adoquines, con ruedas de trazado



No.	L [mm]	
35927	1460	10

EN Broom
 PL Miotła
 DE Strassenbesen
 RU Метла
 CS Metla
 RO Matura
 HU Partvis
 ES Cepillo pelo largo



No.	Working width / Szerokość robocza [mm]	L [mm]	
35911	250	1150	200

EN Broom
 PL Miotła
 DE Strassenbesen
 RU Метла
 CS Metla
 RO Matura
 HU Partvis
 ES Cepillo pelo largo



No.	Working width / Szerokość robocza [mm]	L [mm]	
35912	360	1200	15

EN Broom
 PL Miotła
 DE Strassenbesen
 RU Метла
 CS Metla
 RO Matura
 HU Partvis
 ES Cepillo pelo largo



No.	Working width / Szerokość robocza [mm]	
35893	300	12
35894	400	12
35895	500	12

EN Broom
 PL Miotła
 DE Strassenbesen
 RU Метла
 CS Metla
 RO Matura
 HU Partvis
 ES Cepillo pelo largo



No.	Working width / Szerokość robocza [mm]	
35899	250	12

EN Broom
 PL Miotła
 DE Strassenbesen
 RU Метла
 CS Metla
 RO Matura
 HU Partvis
 ES Cepillo pelo largo



No.	Bristle length / Długość włosia [mm]	
35905	275	12



EN Broom
PL Miotła
DE Strassenbesen
RU Метла
CS Metla
RO Matura
HU Partvis
ES Cepillo pelo largo



FLO

No.	Bristle length / Długość włosia [mm]	
35906	135	12

EN Lawn mover brush
PL Szczotka do kosiarki
DE Rasenmäher Reinigungsbürste mit Schaber
RU Щетка для очистки газонокосилки
CS Kartáč na čištění sekačky
RO Perie pt. curatat motoacoase
HU Ecset a kaszák tisztításához
ES Cepillo limpieza



FLO

No.	Working width / Szerokość robocza [mm]	L [mm]	
35950	50	310	15

EN Microfiber
PL Mikrofibra
DE Mikrofaser
RU Микроволокно
CS Mikrovlákno
RO Microfibră
HU Mikroszálas
ES Microfibra

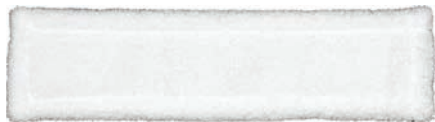

LUND

No.	Size / Rozmiar [mm]	For / Dla	
67171	250x70	67170	500

EN All purpose boot tray
PL Wielofunkcyjna podstawka gospodarcza
DE Garten- und Haushalt-Unterlage
RU Многофункциональный поднос

CS Multifunkční podložka
RO Tava multifunctionala
HU Többfunkciós tálcá
ES Bandeja de arranque universal

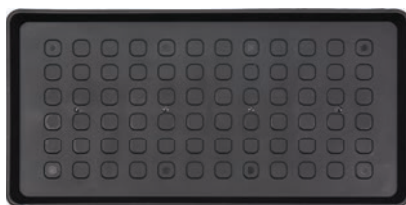

VOREL

No.	[mm]	
67260	780x384x32	30

EN Broom
PL Miotła
DE Strassenbesen
RU Метла
CS Metla
RO Matura
HU Partvis
ES Cepillo pelo largo



FLO

No.	Bristle length / Długość włosia [mm]	
35908	210	8

EN Barbecue cleaning brush
PL Szczotka do grilla
DE Grillbürste
RU Щетка для гриля
CS Kartáč do grilu
RO Perie pt. curatat gratar
HU Grillkefe
ES Cepillo para barbacoa



VOREL

No.	L [mm]	
99528	305	16

EN Mop
PL Zgarniacz do wody
DE Wasserschieber
RU Сгон для уборки воды

CS Sěrka s gumou
RO Mop cauciu
HU Vízlehúzó gumi
ES Recogedor de agua universal



VOREL

No.	L [mm]	
04561	330	12/120
04562	430	10/80

EN Debris bags
PL Worki na gruz, mocne
DE Müllsäcke stabil
RU Мешки для строительного мусора
CS Pytle na sut'
RO Saci pt. demolari
HU Sittes zsák
ES Bolsas para escombros

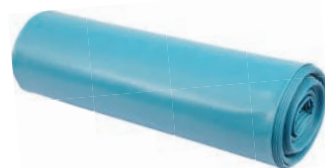

VOREL

No.	Capacity / Pojemność [l]	Thickness / Grubość [µm]	pcs / szt.	
09475	80	142	10	10
09476	80	142	3	10
09477	120	142	10	10
09478	120	142	3	10

- EN Waste bags for styrofoam
 PL Worki na styropian
 DE Styropor Entsorgungssäcke
 RU Пакеты для мусора строительные материалы
- CS Pytle na polystyren
 RO Saci gunoi
 HU Szemeteszsák
 ES Sacos de poliestireno



LDPE



VOREL

No.	Capacity / Pojemność [l]	Thickness / Grubość [µm]	pcs / szt.	
09472	240	40	10	10

- EN Construction waste bags
 PL Worki na odpady budowlane
 DE Müllsäcke
 RU Мешки для строительного мусора
 CS Pytle na stavební odpad
 RO Saci gunoi pt. santier
 HU Zsák építési törmelékhez
 ES Bolsas para desperdicios de construcción

LDPE



VOREL

No.	Capacity / Pojemność [l]	Thickness / Grubość [µm]	pcs / szt.	
09470	80	40	10	30
09471	120	60	15	10

- EN Garden bags with cord
 PL Worki ogrodowe z taśmą
 DE Gartensäcke mit Band
 RU Мусорные пакеты прочные для листьев
- CS Zahradní pytle zatahovací
 RO Saci gunoi pt. gradina cu strangere
 HU Szalagos kerti szemeteszsák
 ES Bolsas de jardín con cinta

STRING TAPE TAŚMA ŚCIGAŁAJĄCA

LDPE



FLO

No.	Capacity / Pojemność [l]	Thickness / Grubość [µm]	pcs / szt.	
09480	60	60	10	12
09482	120	60	10	15

- EN Perforated waste bags for leaves
 PL Worki perforowane na liście
 DE Gartenmüllsäcke perforiert
 RU Мусорные пакеты прочные для листьев
- CS Perforované odpadové pytle na list
 RO Szalagos kerti szemeteszsák
 HU Sac gunoi perforat pt. frunze
 ES Sacos perforadas para residuos de jardín

PERFORATED PERFOROWANY

LDPE



FLO

No.	Capacity / Pojemność [l]	Thickness / Grubość [µm]	pcs / szt.	
09484	200	40	10	12

- EN Waste bags
 PL Worki na odpady, mocne
 DE Müllbeutel
 RU Пакеты для мусора
 CS Pytle na odpad
 RO Saci gunoi
 HU Szemeteszsák
 ES Bolsas para desperdicios

LDPE



VOREL

No.	Capacity / Pojemność [l]	Thickness / Grubość [µm]	pcs / szt.	
09465	120	30	10	25
09466	160	40	10	15
09467	240	40	10	10

- EN Garden bags
 PL Worki ogrodowe
 DE Gartensäcke
 RU Мешки для огорода
 CS Zahradní pytle
 RO Saci gunoi pt. gradina
 HU Kerti szemeteszsák
 ES Bolsas de jardín

LDPE



FLO

No.	Capacity / Pojemność [l]	Thickness / Grubość [µm]	pcs / szt.	
09481	120	60	10	15

- EN Waste bags for grass
 PL Worki perforowane na trawę
 DE Gartenmüllsäcke perforiert
 RU Мусорные пакеты прочные для листьев
 CS Perforované odpadové pytle na tráve
 RO Sac gunoi pt. iarba
 HU Szalagos kerti szemeteszsák
 ES Sacos perforadas para residuos de jardín

PERFORATED PERFOROWANY

LDPE



FLO

No.	Capacity / Pojemność [l]	Thickness / Grubość [µm]	pcs / szt.	
09483	120	35	10	25

- EN Waste bags
 PL Worki na odpady domowe
 DE Müllbeutel
 RU Пакеты для мусора
 CS Pytle na odpad
 RO Saci gunoi
 HU Szemeteszsák
 ES Bolsas para desperdicios



VOREL

No.	Capacity / Pojemność [l]	Thickness / Grubość [µm]	pcs / szt.	Material / Material	
09486	35	6	50	HDPE	40
09487	35	11	30	MDPE	45
09489	60	13	20	MDPE	45

EN Waste bags super strong
 PL Worki na odpady super mocne
 DE Müllsäcke extra stark
 RU Пакеты для мусора прочные
 CS Super- silný pytle na odpad
 RO Sac gunoi super rezistent
 HU Szemeteszsák
 ES Sacos de residuos super fuertes



VOREL

No.	Capacity / Pojemność [l]	Thickness / Grubość [µm]	pcs / szt.	
09473	35	30	50	10

EN Waste bags strong with holder
 PL Worki na odpady z uszami, mocne
 DE Müllsäcke mit Griff stark
 RU Пакеты для мусора с завязками прочные
 CS Odrádkové pytle s rukojetí
 RO Sac gunoi rezistent cu maner
 HU Szemeteszsák
 ES Sacos de desecho fuertes con soporte



VOREL

No.	Capacity / Pojemność [l]	Thickness / Grubość [µm]	pcs / szt.	
09474	60	20	20	25

EN Waste bags
 PL Worki na odpady z nadrukiem
 DE Müllbeutel
 RU Пакеты для мусора
 CS Pytle na odpad
 RO Saci gunoi
 HU Szemeteszsák
 ES Bolsas para desperdicios



VOREL

No.	Capacity / Pojemność [l]	Thickness / Grubość [µm]	pcs / szt.	
10001	60	30	15	30
10011	120	40	10	25

EN Waste bags
 PL Worki na odpady z nadrukiem
 DE Müllbeutel
 RU Пакеты для мусора
 CS Pytle na odpad
 RO Saci gunoi
 HU Szemeteszsák
 ES Bolsas para desperdicios



VOREL

No.	Capacity / Pojemność [l]	Thickness / Grubość [µm]	pcs / szt.	
10003	60	30	15	30
10013	120	40	10	25

EN Waste bags with cord
 PL Worki na odpady domowe z taśmą
 DE Müllbeutel mit Band
 RU Пакеты для мусора с лентой
 CS Pytle na odpad
 RO Saci gunoi
 HU Szemeteszsák
 ES Bolsas para desperdicios



VOREL

No.	Capacity / Pojemność [l]	Thickness / Grubość [µm]	pcs / szt.	
09490	60	30	10	25

EN Waste bags
 PL Worki na odpady z nadrukiem
 DE Müllbeutel
 RU Пакеты для мусора
 CS Pytle na odpad
 RO Saci gunoi
 HU Szemeteszsák
 ES Bolsas para desperdicios



VOREL

No.	Capacity / Pojemność [l]	Thickness / Grubość [µm]	pcs / szt.	
10000	60	30	15	30
10010	120	40	10	25

EN Waste bags
 PL Worki na odpady z nadrukiem
 DE Müllbeutel
 RU Пакеты для мусора
 CS Pytle na odpad
 RO Saci gunoi
 HU Szemeteszsák
 ES Bolsas para desperdicios



VOREL

No.	Capacity / Pojemność [l]	Thickness / Grubość [µm]	pcs / szt.	
10002	60	30	15	30
10012	120	40	10	25

EN Waste bags
 PL Worki na odpady z nadrukiem
 DE Müllbeutel
 RU Пакеты для мусора
 CS Pytle na odpad
 RO Saci gunoi
 HU Szemeteszsák
 ES Bolsas para desperdicios



VOREL

No.	Capacity / Pojemność [l]	Thickness / Grubość [µm]	pcs / szt.	
10014	120	40	10	25

EN Waste bags CS Pytle na odpad
 PL Worki na odpady z nadrukiem RO Saci gunoi
 DE Müllbeutel HU Szemeteszsák
 RU Пакеты для мусора ES Bolsas para desperdicios



No.	Capacity / Pojemność [l]	Thickness / Grubość [µm]	pcs / szt.	
10015	120	40	10	25

EN Tarpaulin CS Plachta
 PL Plandeka RO Husă
 DE Plane HU PONYVA
 RU Тент ES Toldo

57 g/m²



No.	Size / Rozmiar [m]	m [g/m ²]	
85122	2x3	57	30
85123	3x5	57	20
85124	4x5	57	10
85125	4x6	57	8
85126	5x8	57	5
85128	6x10	57	3
85129	8x12	57	2
85130	10x15	57	2

EN Tarpaulin CS Plachta
 PL Plandeka RO Husă
 DE Plane HU PONYVA
 RU Тент ES Toldo

75 g/m²



No.	Size / Rozmiar [m]	m [g/m ²]	
85112	2x3	75	30
85113	3x5	75	10
85114	4x5	75	10
85115	4x6	75	8
85116	5x8	75	5
85118	6x10	75	3
85119	8x12	75	2
85120	10x15	75	2

EN Tarpaulin
 PL Plandeka
 DE Plane
 RU Тент
 CS Plachta
 RO Husă
 HU PONYVA
 ES Toldo

57 g/m²



No.	Size / Rozmiar [m]	m [g/m ²]	
85131	2x3	57	30
85132	3x5	57	20
85133	4x5	57	10
85134	4x6	57	8
85135	5x8	57	5

EN Tarpaulin CS Plachta
 PL Plandeka RO Husă
 DE Plane HU PONYVA
 RU Тент ES Toldo

90 g/m²



No.	Size / Rozmiar [m]	m [g/m ²]	
85020	2x3	90	30
85030	3x5	90	18
85040	4x5	90	9
85050	4x6	90	10
85060	5x8	90	5
85080	6x10	90	4
85090	8x12	90	2
85100	10x15	90	1

EN Tarpaulin clips
 PL Uchwyty zaciskowe ze śrubą do mocowania plandek
 DE Kunststoff Planenhalter
 RU Пластиковый клипс зажим для палаток и тентов
 CS Držáky k zakryvacím plachtám
 RO Clame pt. prelate
 HU PONYVARÓGZÍTŐ KLIPSZ
 ES Pinzas para lonas



No.	pcs / szt.	
85170	8	12/48

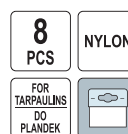

EN Tarpaulin clips
 PL Uchwyty zaciskowe do mocowania plandek
 DE Kunststoff Planenhalter
 RU Пластиковый клипс зажим для палаток и тентов
 CS Držáky k zakrývacím plachtám
 RO Clame pt. prelate
 HU Ponyvárógzító klipsz
 ES Pinzas para lonas

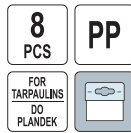

VOREL

No.	pcs / szt.	
85172	8	72

EN Elastic rope
 PL Linka plecioną, elastyczna
 DE Polypropylen-Gummileine
 RU Шнур эластичный
 CS Lano opletené elastické
 RO Funie elastică
 HU Rugalmas kötél
 ES Cuerda trenzada



VOREL

No.	Ø [mm]	L [mm]	
85177	8	15	20
85178	8	30	8

EN Metal pegs for fixing tarpaulins
 PL Szpilki stalowe do mocowania plandek
 DE Metallhaken zum Befestigen von Planen
 RU Металлические колышки для шнуров растяжки тентов и палаток
 CS Kolíky pro plachtoviny
 RO Carlig metallic pt. prelate
 HU Napellenző csapok
 ES Piqueta para lonas

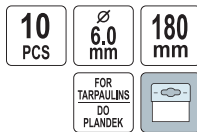

VOREL

No.	pcs / szt.	
85185	10	18/36

EN Tarpaulin repair tape
 PL Taśma klejąca do naprawy plandek
 DE Planen-Reparatur-Klebeband
 RU Самоклеющаяся лента тарпаулиновая, для ремонта тентов
 CS Páska maskovací textilní pro plachtoviny
 RO Bandă adezivă de reparații pt. prelate
 HU Szövetszalag ezüst
 ES Cinta adhesiva de reparación para lonas

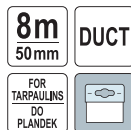

VOREL

No.	W [mm]	L [m]	
85191	50	8	72

EN Tarpaulin clips
 PL Uchwyty zaciskowe do mocowania plandek
 DE Kunststoff Planenhalter
 RU Пластиковый клипс зажим для палаток и тентов
 CS Držáky k zakrývacím plachtám
 RO Clame pt. prelate
 HU Ponyvárógzító klipsz
 ES Pinzas para lonas



VOREL

No.	pcs / szt.	
85174	8	12/48

EN Ball bungee cords
 PL Guma mocująca z kulką
 DE Planenspanner Spanngummi mit Kunststoffkugel
 RU Резиновая петля с шариком
 CS Upínací guma s plastovou kuličkou
 RO Cordelina elastica cu bila fixare
 HU Ponyva rögzítő gumipók
 ES Tensor de goma con bola de plástico

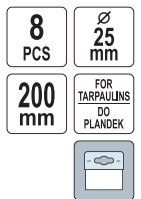

VOREL

No.	pcs / szt.	
85180	8	24/96

EN Tarpaulin repair tape
 PL Taśma klejąca do naprawy plandek
 DE Planen-Reparatur-Klebeband
 RU Самоклеющаяся лента тарпаулиновая, для ремонта тентов
 CS Páska maskovací textilní pro plachtoviny
 RO Bandă adezivă de reparații pt. prelate
 HU Szövetszalag ezüst
 ES Cinta adhesiva de reparación para lonas



VOREL

No.	W [mm]	L [m]	
85190	50	8	72

EN Ash separator
 PL Separator do popiołu
 DE Ascheabscheider
 RU Пелла сепаратор
 CS Odlučovač popela
 RO Filtru pt. cenușă
 HU Hamuporszívó
 ES Separador de ceniza



No.	
72920	1

EN Ash cleaner
 PL Odkurzacz do popiołu
 DE Aschesauger
 RU Пылесос для золы
 CS Vysavač popela
 RO Aspirator pt. cenusa
 HU Hamuporszívó
 ES Aspirador de cenizas

220-240V~50/60Hz	800 W	18 L	14 kPa	FOR GRILL AND FIREPLACE DO GRILLA I KAMINIA
	BLOW FUNCTION FUNKCJA Dmuchawy	FIREPROOF HOSE WAŻ ZARODOPORNY		



No.	Power / Moc [W]	
72928	800	1

EN Car vacuum cleaner
 PL Odkurzacz samochodowy
 DE Handsauger
 RU Ручной пылесос для автомобиля
 CS Vysavač do auta
 RO Aspirator de masina
 HU Autó porszívó
 ES Aspirador para coche

60 W	7.4 V 2000mAh Li-Ion	4-6h
18-20 min	USB CHARGING ŁADOWANIE	HEPA



No.	Battery voltage / Napięcie akumulatora [V d.c.]	Power / Moc [W]	
82955	7.4	60	30

EN Car vacuum cleaner
 PL Odkurzacz samochodowy
 DE Handsauger
 RU Ручной пылесос для автомобиля
 CS Vysavač do auta
 RO Aspirator de masina
 HU Autó porszívó
 ES Aspirador para coche

100 W	12 V		BAGLESS BEZ-WORKOWY	
--------------	-------------	--	----------------------------	--



No.	Voltage / Napięcie [V d.c.]	Power / Moc [W]	
82952	12	100	20

EN Ash cleaner
 PL Odkurzacz do popiołu
 DE Aschesauger
 RU Пылесос для золы
 CS Vysavač popela
 RO Aspirator pt. cenusa
 HU Hamuporszívó
 ES Aspirador de cenizas

220-240V~50/60Hz	800 W	20 L	16 kPa	FOR GRILL AND FIREPLACE DO GRILLA I KAMINIA
	BLOW FUNCTION FUNKCJA Dmuchawy	FIREPROOF HOSE WAŻ ZARODOPORNY		



No.	Power / Moc [W]	
78870	800	1

EN Car vacuum cleaner
 PL Odkurzacz samochodowy
 DE Handsauger
 RU Ручной пылесос для автомобиля
 CS Vysavač do auta
 RO Aspirator de masina
 HU Autó porszívó
 ES Aspirador para coche

100 W	12 V	
WET AND DRY SUCHO I MOKRO	BAGLESS BEZ-WORKOWY	



No.	Voltage / Napięcie [V d.c.]	Power / Moc [W]	
82951	12	100	8

EN Car vacuum cleaner
 PL Odkurzacz samochodowy
 DE Handsauger
 RU Ручной пылесос для автомобиля
 CS Vysavač do auta
 RO Aspirator de masina
 HU Autó porszívó
 ES Aspirador para coche

80W VACUUM CLEANER ODKURZACZ	120W COMPRESSOR KOMPRESOR
12 V	20 l/min
1.0 MPa	
BAGLESS BEZ-WORKOWY	

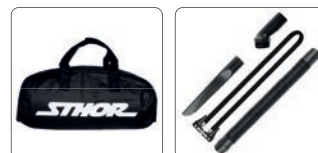

No.	Voltage / Napięcie [V d.c.]	Vacuum cleaner power / Moc odkurzacza [W]	Compressor power / Moc kompresora [W]	
82953	12	80	120	12

EN Car vacuum cleaner
 PL Odkurzacz samochodowy
 DE Handsauger
 RU Ручной пылесос для автомобиля
 CS Vysavač do auta
 RO Aspirator de masina
 HU Autó porszívó
 ES Aspirador para coche



100 W 12 V
 CYCLONIC CYKLONOWY BAGLESS BEZ-WORKOWY
 3m



STHOR

No.	Voltage / Napięcie [V d.c.]	Power / Moc [W]	
82967	12	100	9

EN Rechargeable car vacuum cleaner
 PL Odkurzacz samochodowy bezprzewodowy
 DE Kabelloser Auto-Staubsauger
 RU Беспроводной пылесос автомобиля
 CS Bezdrátový automobilový vysavač
 RO Aspirator de mașină fără fir
 HU Vezeték nélküli autós porszívó
 ES Aspirador de coche inalámbrico



100 W 2600 mAh Li-Ion
 5-6h 15-18 min
 USB BATTERY CHARGER LADONIKKA CYCLONIC CYKLONOWY
 BAGLESS BEZ-WORKOWY



STHOR

No.	Voltage / Napięcie [V d.c.]	Power / Moc [W]	
82970	5	100	9

EN Filter
 PL Filtr
 DE Filter
 RU Фильтр
 CS Filtr
 RO Filtru
 HU Szűrő
 ES Filtro



VOREL

No.	For / Dla	
72931	78870	40

EN Car vacuum cleaner
 PL Odkurzacz samochodowy
 DE Handsauger
 RU Ручной пылесос для автомобиля
 CS Vysavač do auta
 RO Aspirator de masina
 HU Autó porszívó
 ES Aspirador para coche



80 W 7.4 V 2000mAh Li-Ion 4h
 20min CYCLONIC CYKLONOWY BAGLESS BEZ-WORKOWY



STHOR

No.	Voltage / Napięcie [V d.c.]	Power / Moc [W]	
82954	7.4	80	20

EN Rechargeable car vacuum cleaner
 PL Odkurzacz samochodowy bezprzewodowy
 DE Kabelloser Auto-Staubsauger
 RU Беспроводной пылесос автомобиля
 CS Bezdrátový automobilový vysavač
 RO Aspirator de mașină fără fir
 HU Vezeték nélküli autós porszívó
 ES Aspirador de coche inalámbrico



100 W 2600 mAh Li-Ion
 5-6h 15-18 min
 USB BATTERY CHARGER LADONIKKA CYCLONIC CYKLONOWY
 BAGLESS BEZ-WORKOWY



STHOR

No.	Voltage / Napięcie [V d.c.]	Power / Moc [W]	
82971	5	100	9

EN Metal hose
 PL Wąż metalowy
 DE Metallschlauch
 RU Металлический шланг
 CS Kovová hadice
 RO Furtun metalic
 HU Hajlékony, fém tömlő
 ES Manguera de metal

1m 38 mm GALVANIZED STEEL STAL OCYNKOWANA



VOREL

No.	For / Dla	
72922	72920	20

- EN Metal hose
- PL Waż metalowy
- DE Metallschlauch
- RU Металлический шланг
- CS Kovová hadice
- RO Furtun metalic
- HU Hajlékony, fém tömlő
- ES Manguera de metal



1m ∅ 38 mm Al 23cm



No.	For / Dla	
72932	72930	15

- EN Syphon pump
- PL Pompa syfonowa
- DE Siphon-Pumpe
- RU Сифонный насос
- CS Pumpa syfónová
- RO Pompa manuala pt. combustibil
- HU Szifon pumpa
- ES Bomba de sifón

10 l/min ∅ 25 mm 850 mm

∅ 22 mm 130 mm 5-50 °C



No.		
78021		24

- EN Drain cleaner
- PL Pistolet do udrażniania rur
- DE Pistole zum Reinigen von Rohren
- RU Пневматический пистолет для прочистки труб
- CS Pistole na čištění trubek
- RO Pistolă pt. curățarea țevilor
- HU Csőtisztító pisztoly
- ES Pistola desatacaños

∅ 135 mm



No.	∅ [mm]	
55500	63, 135	10

- EN Drain auger
- PL Spirala kanalizacyjna
- DE Hand-Rohrreinigungsspirale
- RU Трос сантехнический для чистки труб
- CS Spirála kanalizační
- RO Dispozitiv de defundat scurgere
- HU Csőtisztító spirál
- ES Desatascador espiral

GALVANIZED STEEL STAL OCYNKOWANA

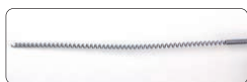

No.	∅ [mm]	L [m]	
55541	5	1.5	20/80
55542	6	3.0	18/36

- EN Syphon pump
- PL Pompa syfonowa
- DE Siphon-Pumpe
- RU Сифонный насос
- CS Pumpa syfónová
- RO Pompa manuala pt. combustibil
- HU Szifon pumpa
- ES Bomba de sifón

6.2 l/min ∅ 14 mm 390 mm

∅ 12 mm 540 mm 5-50 °C



No.		
78020		30/60

- EN Multi-purpose pump
- PL Pompa wielofunkcyjna
- DE Multifunktionale Pumpe
- RU Многофункциональный насос
- CS Univerzální pumpička
- RO Pompă multifuncțională
- HU Többfunkciós szivattyú
- ES Bomba multusos

140 cm 3x120cm WATER OIL GASOLINE TOLUENE BENZINA PP PVC



No.		
78022		6/24

- EN Drain suction pump
- PL Pompa do udrażniania kanalizacji
- DE Hochdruck-Rohrreinger
- RU Пневматический вантус для прочистки труб
- CS Čerpadlo na čištění trubek
- RO Pompă pt. curățarea țevilor
- HU Csőtisztító szivattyú
- ES El desagüe del fregadero limpiador

∅ 65 mm ∅ 155 mm



No.	∅ [mm]	
55505	65, 155	24

- EN Drain auger
- PL Spirala kanalizacyjna
- DE Hand-Rohrreinigungsspirale
- RU Трос сантехнический для чистки труб
- CS Spirála kanalizační
- RO Dispozitiv de defundat scurgere
- HU Csőtisztító spirál
- ES Desatascador espiral

GALVANIZED STEEL STAL OCYNKOWANA



No.	∅ [mm]	L [m]	
55544	9	5	5/10
55545	9	10	4/8

EN Vaseline CS Technická vazelína
 PL Wazelina techniczna RO Vaseline tehnică
 DE Vaseline HU Műszaki vazelin
 RU Вазелин технический ES Vaseline tecnica



No.	Capacity / Pojemność [ml]	
86700	50	50
86701	100	50

EN Foldable hand truck
 PL Składany wózek magazynowy
 DE Klappbare Transportkarre
 RU Складная тележка
 CS Skladací hliníkový rudi
 RO Carucior cu manere pliable
 HU Összecsukható kézikocsi
 ES Carretilla de mano plegable



No.	Max. load capacity / Maks. obciążenie [kg]	
78660	70	1

EN Foldable hand truck
 PL Składany wózek magazynowy
 DE Klappbare Transportkarre
 RU Складная тележка
 CS Skladací hliníkový rudi
 RO Carucior cu manere pliable
 HU Összecsukható kézikocsi
 ES Carretilla de mano plegable



No.	Max. load capacity / Maks. obciążenie [kg]	
78662	70	5

EN Foldable hand truck
 PL Składany wózek magazynowy
 DE Klappbare Transportkarre
 RU Складная тележка
 CS Skladací hliníkový rudi
 RO Carucior cu manere pliable
 HU Összecsukható kézikocsi
 ES Carretilla de mano plegable



No.	Max. load capacity / Maks. obciążenie [kg]	
78661	90	1

EN Foldable hand truck
 PL Składany wózek magazynowy
 DE Klappbare Transportkarre
 RU Складная тележка
 CS Skladací hliníkový rudi
 RO Carucior cu manere pliable
 HU Összecsukható kézikocsi
 ES Carretilla de mano plegable



No.	Max. load capacity / Maks. obciążenie [kg]	
78663	130	1

EN Lifting and moving straps
 PL Pasy do przenoszenia mebli
 DE Gürtel zum Bewegen von Heben
 RU Ремни для переноски мебели
 CS Pohyblivé pásy pro zvedání nábytku
 RO Curele pt. mutar obiecte
 HU Emelő mozgó pántok
 ES Cinturones para llevar muebles

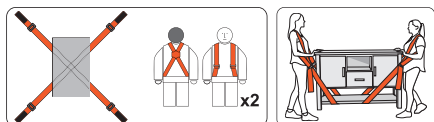

No.	pcs / szt.	
74721	4	10/20

EN Lifting and moving strap
 PL Pas do przenoszenia ładunku
 DE Gürtel zum Bewegen von Heben
 RU Такелажный ремень для переноски грузов
 CS Pás pro ruční přenášení nákladu
 RO Curea pt. mutar obiecte
 HU Melő mozgó pánt
 ES Cinturón para llevar carga

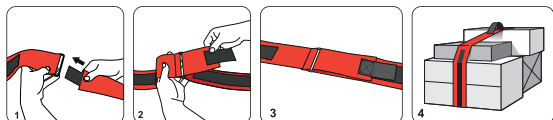

No.	pcs / szt.
74723	32/128

EN Furniture transport roller set
 PL Zestaw rolek do transportu mebli
 DE Möbel transportroller set
 RU Набор для перемещения мебели
 CS Sada na stěhování nábytku
 RO Set transport si ridicat mobila
 HU Bútorszállító készlet
 ES Muebles transporte conjunto



No.	pcs / szt.	
87245	5	12

EN Lifting and moving straps
 PL Pasy do przenoszenia mebli
 DE Gürtel zum Bewegen von Heben
 RU Ремни для переноски мебели
 CS Pohyblivé pásy pro zvedání nábytku
 RO Curele pt. mutar obiecte
 HU Emelő mozgó pántok
 ES Cinturones para llevar muebles

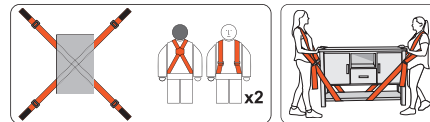

No.	pcs / szt.	
74722	4	15/30

EN Lifting and moving straps
 PL Pasy do przenoszenia mebli
 DE Gürtel zum Bewegen von Heben
 RU Ремни для переноски мебели
 CS Pohyblivé pásy pro zvedání nábytku
 RO Curele pt. mutar obiecte
 HU Emelő mozgó pántok
 ES Cinturones para llevar muebles

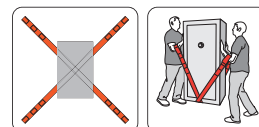

No.	pcs / szt.	
74724	2	33/66

EN Fixed caster
 PL Kółko stałe
 DE Bockrolle
 RU Ролик с стационарной опорой
 CS Pevné kolečko
 RO Roata de carucior fixa
 HU Szállítógörgők
 ES Rueda fija



No.	Ø [mm]	W [mm]	H [mm]	Max. load capacity / Maks. obciążenie [kg]	
87301	75	23	97	40	60
87302	100	27	130	60	32
87303	125	34	155	100	22
87305	160	40	195	130	10
87307	200	46	235	150	8

EN Swivel caster
 PL Kółko skrętne z czarną gumą
 DE Lenkrolle mit Feststeller
 RU Ролик с вращающийся опорой
 CS Otočné kolečko
 RO Roata de carucior mobila
 HU Szállítógörgők
 ES Rueda giratoria con freno



No.	Ø [mm]	W [mm]	H [mm]	Max. load capacity / Maks. obciążenie [kg]	
87311	75	23	97	40	48
87312	100	27	130	60	26
87313	125	34	155	100	20
87315	160	40	195	130	10
87317	200	46	235	150	6

EN Swivel caster
 PL Kółko skrętne z szarą gumą
 DE Lenkrolle mit Feststeller
 RU Ролик с вращающийся опорой
 CS Otočné kolečko
 RO Roata de carucior mobila
 HU Szállítógörgők
 ES Rueda giratoria con freno



No.	Ø [mm]	W [mm]	H [mm]	Max. load capacity / Maks. obciążenie [kg]	
87331	75	22	97	40	38
87332	100	26	130	60	24
87333	125	33	153	100	18
87335	160	39	190	130	8
87337	200	44	230	150	6

EN Swivel caster
 PL Kółko skrętne z szarą gumą
 DE Lenkrolle mit Feststeller
 RU Ролик с вращающийся опорой
 CS Otočné kolečko
 RO Roata de carucior mobila
 HU Szállítógörgők
 ES Rueda giratoria con freno



No.	Ø [mm]	W [mm]	H [mm]	Max. load capacity / Maks. obciążenie [kg]	
87361	50	16	72	20	100
87362	75	21	104	30	52
87363	100	26	134	45	28
87364	125	27	161	50	24

EN Swivel caster
 PL Kółko skrętne z czarną gumą
 DE Lenkrolle mit Feststeller
 RU Ролик с вращающийся опорой
 CS Otočné kolečko
 RO Roata de carucior mobila
 HU Szállítógörgők
 ES Rueda giratoria con freno



No.	Ø [mm]	W [mm]	H [mm]	Max. load capacity / Maks. obciążenie [kg]	
87321	75	23	97	40	40
87322	100	27	130	60	20
87323	125	34	155	100	16
87325	160	40	195	130	8
87327	200	46	235	150	6

EN Swivel caster
 PL Kółko skrętne z szarą gumą
 DE Lenkrolle mit Feststeller
 RU Ролик с вращающийся опорой
 CS Otočné kolečko
 RO Roata de carucior mobila
 HU Szállítógörgők
 ES Rueda giratoria con freno



No.	Ø [mm]	W [mm]	H [mm]	Max. load capacity / Maks. obciążenie [kg]	
87351	50	16	72	20	140
87352	75	21	104	30	60
87353	100	26	134	45	38
87354	125	27	161	50	25

EN Swivel caster
 PL Kółko skrętne z szarą gumą
 DE Lenkrolle mit Feststeller
 RU Ролик с вращающийся опорой
 CS Otočné kolečko
 RO Roata de carucior mobila
 HU Szállítógörgők
 ES Rueda giratoria con freno



No.	Ø [mm]	W [mm]	H [mm]	Max. load capacity / Maks. obciążenie [kg]	
87371	50	16	70	20	120
87372	75	21	101	30	64
87373	100	26	132	45	34
87374	125	27	158	50	24

EN Swivel caster
 PL Kółko skrętne z szarą gumą
 DE Lenkrolle mit Feststeller
 RU Ролик с вращающийся опорой

CS Otočné kolečko
 RO Roata de carucior mobila
 HU Szállítógörgők
 ES Rueda giratoria con freno

°C -10 +50
 RUBBER GUMA
 BRAKE HAMULEC
 PLAIN BEARING ŁOŻYSKO ŚLIZGOWE



No.	Ø [mm]	W [mm]	H [mm]	Max. load capacity / Maks. obciążenie [kg]	
87381	50	16	72	20	96
87382	75	21	104	30	50
87383	100	26	134	45	26
87384	125	27	161	50	22

EN Swivel caster
 PL Kółko skrętne
 DE Lenkrolle mit Feststeller
 RU Ролик с вращающийся опорой

CS Otočné kolečko
 RO Roata de carucior mobila
 HU Szállítógörgők
 ES Rueda giratoria con freno

°C -10 +50
 RUBBER GUMA
 POM BEARING ŁOŻYSKO POM



No.	Ø [mm]	W [mm]	H [mm]	Max. load capacity / Maks. obciążenie [kg]	
87401	40	17	54	20	260
87402	50	22	65	25	120
87403	65	23	84	30	78

EN Swivel caster
 PL Kółko skrętne
 DE Lenkrolle mit Feststeller
 RU Ролик с вращающийся опорой

CS Otočné kolečko
 RO Roata de carucior mobila
 HU Szállítógörgők
 ES Rueda giratoria con freno

°C -15 +80
 POLYAMIDE POLIAND



No.	Ø [mm]	W [mm]	H [mm]	Max. load capacity / Maks. obciążenie [kg]	
87431	75	23	97	40	60
87432	100	31	130	60	32
87433	125	33	155	100	26
87435	160	40	195	130	12
87437	200	40	235	150	8

EN Fixed caster
 PL Kółko stałe
 DE Bockrolle
 RU Ролик с стационарной опорой

CS Pevné kolečko
 RO Roata de carucior fixa
 HU Szállítógörgők
 ES Rueda fija

°C -10 +50
 RUBBER GUMA
 POM BEARING ŁOŻYSKO POM



No.	Ø [mm]	W [mm]	H [mm]	Max. load capacity / Maks. obciążenie [kg]	
87391	40	17	54	20	280
87392	50	22	65	25	130
87393	65	23	84	30	90

EN Swivel caster
 PL Kółko skrętne
 DE Lenkrolle mit Feststeller
 RU Ролик с вращающийся опорой

CS Otočné kolečko
 RO Roata de carucior mobila
 HU Szállítógörgők
 ES Rueda giratoria con freno

°C -10 +50
 RUBBER GUMA
 BRAKE HAMULEC
 POM BEARING ŁOŻYSKO POM



No.	Ø [mm]	W [mm]	H [mm]	Max. load capacity / Maks. obciążenie [kg]	
87411	40	17	54	20	230
87412	50	22	65	25	110
87413	65	23	84	30	72

EN Wheel
 PL Kółko czarna guma
 DE Transportrad
 RU Ролик

CS Kolečko
 RO Roata de carucior
 HU Önálló görgők
 ES Rueda

°C -10 +50
 RUBBER GUMA



No.	Ø [mm]	W [mm]	Axle diameter / Średnica osi [mm]	Axle length / Długość osi [mm]	Max. load capacity / Maks. obciążenie [kg]	
87451	75	22	12	30	40	150
87452	100	26	12	40	60	66
87453	125	33	15	40	100	36
87454	150	39	20	55	110	22
87455	160	39	20	55	130	20
87456	200	44	20/25	55	150	12
87457	250	48	20/25	55	180	8

EN Seal for windows and doors
 PL Uszczelka do okien i drzwi
 DE Dichtung für Fenster und Türen
 RU Уплотнители для окон и дверей
 CS Těsnění oken a dveří
 RO Seal pt. ferestre si usi
 HU Seal az ablakok és ajtók
 ES Sellar para ventanas y puertas



No.	Size / Rozmiar [mm]	L [m]	Type / Typ	Color / Kolor	
76752	9x7.4	6	D	biały	24
76762	9x7.4	6	D	brązowy	24

EN Seal for windows and doors
 PL Uszczelka do okien i drzwi
 DE Dichtung für Fenster und Türen
 RU Уплотнители для окон и дверей
 CS Těsnění oken a dveří
 RO Seal pt. ferestre si usi
 HU Seal az ablakok és ajtók
 ES Sellar para ventanas y puertas

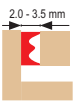

No.	Size / Rozmiar [mm]	L [m]	Type / Typ	Color / Kolor	
76750	9x4	6	E	biały	24
76760	9x4	6	E	brązowy	24

EN Seal for windows and doors
 PL Uszczelka do okien i drzwi
 DE Dichtung für Fenster und Türen
 RU Уплотнители для окон и дверей
 CS Těsnění oken a dveří
 RO Seal pt. ferestre si usi
 HU Seal az ablakok és ajtók
 ES Sellar para ventanas y puertas



No.	Size / Rozmiar [mm]	L [m]	Type / Typ	Color / Kolor	
76751	9x5.5	6	P	biały	24
76761	9x5.5	6	P	brązowy	24

EN Self-adhesive pad for furniture
 PL Podkładka samoprzylepna, korkowa
 DE Klebgleiter für Möbel
 RU Самоклеящая подкладка под мебель

CS Podložka samolepící pod nábytek
 RO Adeziv pad sub mobilier
 HU Őntapadó, bútöríáb alátét
 ES Arandela adhesiva bajo los muebles

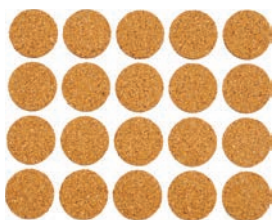

No.	Ø [mm]	pcs / szt.	
74802	20	20	60/720
74804	28	12	60/720

EN Seal for windows and doors
 PL Uszczelka do okien i drzwi
 DE Dichtung für Fenster und Türen
 RU Уплотнители для окон и дверей
 CS Těsnění oken a dveří
 RO Seal pt. ferestre si usi
 HU Seal az ablakok és ajtók
 ES Sellar para ventanas y puertas

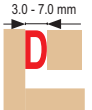

No.	Size / Rozmiar [mm]	L [m]	Type / Typ	Color / Kolor	
76757	9x7.4	100	D	biały	6
76767	9x7.4	100	D	brązowy	6

EN Seal for windows and doors
 PL Uszczelka do okien i drzwi
 DE Dichtung für Fenster und Türen
 RU Уплотнители для окон и дверей
 CS Těsnění oken a dveří
 RO Seal pt. ferestre si usi
 HU Seal az ablakok és ajtók
 ES Sellar para ventanas y puertas

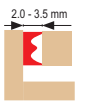

No.	Size / Rozmiar [mm]	L [m]	Type / Typ	Color / Kolor	
76755	9x4	150	E	biały	6
76765	9x4	150	E	brązowy	6

EN Seal for windows and doors
 PL Uszczelka do okien i drzwi
 DE Dichtung für Fenster und Türen
 RU Уплотнители для окон и дверей
 CS Těsnění oken a dveří
 RO Seal pt. ferestre si usi
 HU Seal az ablakok és ajtók
 ES Sellar para ventanas y puertas

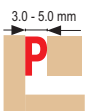

No.	Size / Rozmiar [mm]	L [m]	Type / Typ	Color / Kolor	
76756	9x5.5	100	P	biały	6
76766	9x5.5	100	P	brązowy	6

EN Self-adhesive pad for furniture
 PL Podkładka samoprzylepna, korkowa
 DE Klebgleiter für Möbel
 RU Самоклеящая подкладка под мебель

CS Podložka samolepící pod nábytek
 RO Adeziv pad sub mobilier
 HU Őntapadó, bútöríáb alátét
 ES Arandela adhesiva bajo los muebles



No.	Size / Rozmiar [mm]	pcs / szt.	
74812	100x120	1	60/720

EN Self-adhesive pad for furniture
 PL Podkładka samoprzylepna, antypoślizgowa
 DE Klebegleiter für Möbel
 RU Самоклеящая подкладка под мебель
 CS Podložka samolepící pod nábytek
 RO Adeziv pad sub mobilier
 HU Öntapadó, bútortáblá alátét
 ES Arandela adhesiva bajo los muebles

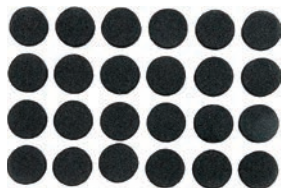

No.	Ø [mm]	pcs / szt.	
74816	10	24	60/720
74818	20	20	60/720
74820	28	12	60/720

EN Self-adhesive pad for furniture
 PL Podkładka samoprzylepna z włókniny
 DE Klebegleiter für Möbel
 RU Самоклеящая подкладка под мебель
 CS Podložka samolepící pod nábytek
 RO Adeziv pad sub mobilier
 HU Öntapadó, bútortáblá alátét
 ES Arandela adhesiva bajo los muebles



No.	Ø [mm]	pcs / szt.	
74831	20	20	60/720
74833	28	12	60/720
74835	40	4	60/720

EN Self-adhesive pad for furniture
 PL Podkładka samoprzylepna z włókniny
 DE Klebegleiter für Möbel
 RU Самоклеящая подкладка под мебель
 CS Podložka samolepící pod nábytek
 RO Adeziv pad sub mobilier
 HU Öntapadó, bútortáblá alátét
 ES Arandela adhesiva bajo los muebles



No.	Size / Rozmiar [mm]	pcs / szt.	
74841	20x20	20	60/720
74843	28x28	12	60/720

EN Self-adhesive pad for furniture
 PL Podkładka samoprzylepna z włókniny
 DE Klebegleiter für Möbel
 RU Самоклеящая подкладка под мебель
 CS Podložka samolepící pod nábytek
 RO Adeziv pad sub mobilier
 HU Öntapadó, bútortáblá alátét
 ES Arandela adhesiva bajo los muebles



No.	Size / Rozmiar [mm]	pcs / szt.	
74849	100x120	1	60/720

EN Self-adhesive pad for furniture
 PL Podkładka samoprzylepna, antypoślizgowa
 DE Klebegleiter für Möbel
 RU Самоклеящая подкладка под мебель
 CS Podložka samolepící pod nábytek
 RO Adeziv pad sub mobilier
 HU Öntapadó, bútortáblá alátét
 ES Arandela adhesiva bajo los muebles



No.	Size / Rozmiar [mm]	pcs / szt.	
74828	100x120	1	60/720

EN Self-adhesive pad for furniture
 PL Podkładka samoprzylepna z włókniny mix
 DE Klebegleiter für Möbel
 RU Самоклеящая подкладка под мебель
 CS Podložka samolepící pod nábytek
 RO Adeziv pad sub mobilier
 HU Öntapadó, bútortáblá alátét
 ES Arandela adhesiva bajo los muebles



No.	Ø [mm]	pcs / szt.	
74838	20, 38	12	60/720

EN Self-adhesive pad for furniture
 PL Podkładka samoprzylepna z włókniny
 DE Klebegleiter für Möbel
 RU Самоклеящая подкладка под мебель
 CS Podložka samolepící pod nábytek
 RO Adeziv pad sub mobilier
 HU Öntapadó, bútortáblá alátét
 ES Arandela adhesiva bajo los muebles



No.	Size / Rozmiar [mm]	pcs / szt.	
74846	20x45	10	60/720

EN Self-adhesive pad for furniture
 PL Podkładka samoprzylepna z włókniny mix
 DE Klebegleiter für Möbel
 RU Самоклеящая подкладка под мебель
 CS Podložka samolepící pod nábytek
 RO Adeziv pad sub mobilier
 HU Öntapadó, bútortáblá alátét
 ES Arandela adhesiva bajo los muebles

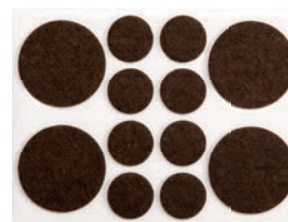

No.	Ø [mm]	pcs / szt.	
74858	20, 38	12	60/720

EN Self-adhesive pad for furniture
 PL Podkładka samoprzylepna z włókniny
 DE Klebegleiter für Möbel
 RU Самоклеящая подкладка под мебель
 CS Podložka samolepící pod nábytek
 RO Adeziv pad sub mobilier
 HU Őntapadó, bútorláb alátét
 ES Arandela adhesiva bajo los muebles

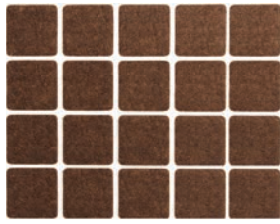

VOREL

No.	Size / Rozmiar [mm]	pcs / szt.	
74861	20x20	20	60/720
74863	28x28	20	60/720

EN Self-adhesive pad for furniture
 PL Podkładka samoprzylepna z włókniny
 DE Klebegleiter für Möbel
 RU Самоклеящая подкладка под мебель
 CS Podložka samolepící pod nábytek
 RO Adeziv pad sub mobilier
 HU Őntapadó, bútorláb alátét
 ES Arandela adhesiva bajo los muebles



VOREL

No.	Size / Rozmiar [mm]	pcs / szt.	
74866	20x45	10	60/720

EN Self-adhesive pad for furniture
 PL Podkładka samoprzylepna, antypoślizgowa
 DE Klebegleiter für Möbel
 RU Самоклеящая подкладка под мебель
 CS Podložka samolepící pod nábytek
 RO Adeziv pad sub mobilier
 HU Őntapadó, bútorláb alátét
 ES Arandela adhesiva bajo los muebles

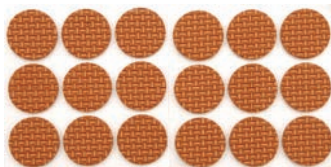

VOREL

No.	Ø [mm]	pcs / szt.	
74882	25	18	24/432

EN Self-adhesive silicone pad for furniture
 PL Podkładka samoprzylepna, silikonowa
 DE Klebegleiter für Möbel
 RU Самоклеящая подкладка под мебель
 CS Podložka samolepící pod nábytek
 RO Adeziv pad sub mobilier
 HU Őntapadó, bútorláb alátét
 ES Arandela adhesiva bajo los muebles



VOREL

No.	Ø [mm]	pcs / szt.	
74910	8	25	32/576
74911	10	20	32/576
74912	13	12	32/576
74913	15	9	32/576
74914	19	6	32/576

EN Self-adhesive pad for furniture
 PL Podkładka samoprzylepna z włókniny
 DE Klebegleiter für Möbel
 RU Самоклеящая подкладка под мебель
 CS Podložka samolepící pod nábytek
 RO Adeziv pad sub mobilier
 HU Őntapadó, bútorláb alátét
 ES Arandela adhesiva bajo los muebles



VOREL

No.	Ø [mm]	pcs / szt.	
74851	20	20	60/720
74853	28	12	60/720
74855	40	4	60/720
74856	50	2	60/720

EN Self-adhesive pad for furniture
 PL Podkładka samoprzylepna z włókniny
 DE Klebegleiter für Möbel
 RU Самоклеящая подкладка под мебель
 CS Podložka samolepící pod nábytek
 RO Adeziv pad sub mobilier
 HU Őntapadó, bútorláb alátét
 ES Arandela adhesiva bajo los muebles



VOREL

No.	Size / Rozmiar [mm]	pcs / szt.	
74869	100x120	1	60/720

EN Self-adhesive pad for furniture
 PL Podkładka samoprzylepna, antypoślizgowa
 DE Klebegleiter für Möbel
 RU Самоклеящая подкладка под мебель
 CS Podložka samolepící pod nábytek
 RO Adeziv pad sub mobilier
 HU Őntapadó, bútorláb alátét
 ES Arandela adhesiva bajo los muebles

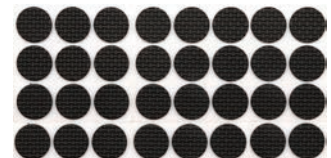

VOREL

No.	Ø [mm]	pcs / szt.	
74885	18	32	24/432
74886	25	18	24/432
74887	38	8	24/432



- EN Felt & plastic furniture glides
- PL Podkładki plastikowo-filcowe na gwóźdź
- DE Kunststoff- und Filzgleiter zum Nageln
- RU Подкладки пластиковые фильцевые на гвоздь
- CS Plastové podložky s plstí na hřebík
- RO Șaibe din plastic-pâslă pt. cuie
- HU Műanyag-filc alátét szöghöz
- ES Arandelas de plástico y fieltro con clave



No.	Ø [mm]	pcs / szt.	
74920	17	16	16/288
74921	20	12	16/288
74922	24	12	16/288
74923	28	8	16/256
74924	30	8	16/256

- EN Plastic stool
- PL Stolek plastikowy
- DE Kunststoff Hocker
- RU Пластиковый табурет
- CS Plastová stolička
- RO Scaun de plastic
- HU Műanyag széklét
- ES Taburete de plástico



No.	Dimensions / Wymiary [mm]	
75916	300x200x210	10/20

- EN Self-adhesive hanging hooks
- PL Haczyki naścienne samoprzylepne
- DE Selbstklebende Wandhaken
- RU Крючки настенные на липучках
- CS Háčky nástěnné samolepící
- RO Cârlige perete autocolante
- HU Műanyag, fali kampó, öntapadós
- ES Ganchos adhesivos para pared



No.	Max. lifting capacity / Maks. udźwig [kg]	pcs / szt.	
74732	1	3	12/192

- EN Plastic stool
- PL Stolek plastikowy
- DE Kunststoff Hocker
- RU Пластиковый табурет
- CS Plastová stolička
- RO Scaun de plastic
- HU Műanyag széklét
- ES Taburete de plástico



No.	Dimensions / Wymiary [mm]	
75915	300x200x210	10/20

- EN Self-adhesive hanging hooks
- PL Haczyki naścienne samoprzylepne
- DE Selbstklebende Wandhaken
- RU Крючки настенные на липучках
- CS Háčky nástěnné samolepící
- RO Cârlige perete autocolante
- HU Műanyag, fali kampó, öntapadós
- ES Ganchos adhesivos para pared



No.	Max. lifting capacity / Maks. udźwig [kg]	pcs / szt.	
74730	1	3	12/144

- EN Self-adhesive hanging hooks
- PL Haczyki naścienne samoprzylepne
- DE Selbstklebende Wandhaken
- RU Крючки настенные на липучках
- CS Háčky nástěnné samolepící
- RO Cârlige perete autocolante
- HU Műanyag, fali kampó, öntapadós
- ES Ganchos adhesivos para pared



No.	Max. lifting capacity / Maks. udźwig [kg]	pcs / szt.	
74731	0.8	3	18/216

EN Self-adhesive hanging hooks
 PL Haczyki naścienne samoprzylepne
 DE Selbstklebende Wandhaken
 RU Крючки настенные на липучках
 CS Háčky nástěnné samolepící
 RO Cârîige perete autocolante
 HU Műanyag, fali kampó, öntapadós
 ES Ganchos adhesivos para pared



No.	Max. lifting capacity / Maks. udźwig [kg]	pcs / szt.	
74733	0.8	4	12/192

EN Self-adhesive hanging hooks
 PL Haczyki naścienne samoprzylepne
 DE Selbstklebende Wandhaken
 RU Крючки настенные на липучках
 CS Háčky nástěnné samolepící
 RO Cârîige perete autocolante
 HU Műanyag, fali kampó, öntapadós
 ES Ganchos adhesivos para pared



No.	Max. lifting capacity / Maks. udźwig [kg]	pcs / szt.	
74740	0.6	3	12/216

EN Self-adhesive hanging hooks
 PL Haczyki naścienne samoprzylepne
 DE Selbstklebende Wandhaken
 RU Крючки настенные на липучках
 CS Háčky nástěnné samolepící
 RO Cârîige perete autocolante
 HU Műanyag, fali kampó, öntapadós
 ES Ganchos adhesivos para pared



No.	Max. lifting capacity / Maks. udźwig [kg]	pcs / szt.	
74744	1	2	8/144

EN Self-adhesive hanging hooks
 PL Haczyki naścienne samoprzylepne
 DE Selbstklebende Wandhaken
 RU Крючки настенные на липучках
 CS Háčky nástěnné samolepící
 RO Cârîige perete autocolante
 HU Műanyag, fali kampó, öntapadós
 ES Ganchos adhesivos para pared



No.	Max. lifting capacity / Maks. udźwig [kg]	pcs / szt.	
74751	0.8	3	16/192

EN Self-adhesive hanging hooks
 PL Haczyki naścienne samoprzylepne
 DE Selbstklebende Wandhaken
 RU Крючки настенные на липучках
 CS Háčky nástěnné samolepící
 RO Cârîige perete autocolante
 HU Műanyag, fali kampó, öntapadós
 ES Ganchos adhesivos para pared

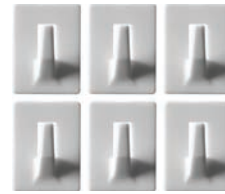

No.	Max. lifting capacity / Maks. udźwig [kg]	pcs / szt.	
74734	0.4	6	12/192

EN Self-adhesive hanging hooks
 PL Haczyki naścienne samoprzylepne
 DE Selbstklebende Wandhaken
 RU Крючки настенные на липучках
 CS Háčky nástěnné samolepící
 RO Cârîige perete autocolante
 HU Műanyag, fali kampó, öntapadós
 ES Ganchos adhesivos para pared



No.	Max. lifting capacity / Maks. udźwig [kg]	pcs / szt.	
74741	1.5	2	12/216

EN Self-adhesive hanging hooks
 PL Haczyki naścienne samoprzylepne
 DE Selbstklebende Wandhaken
 RU Крючки настенные на липучках
 CS Háčky nástěnné samolepící
 RO Cârîige perete autocolante
 HU Műanyag, fali kampó, öntapadós
 ES Ganchos adhesivos para pared



No.	Max. lifting capacity / Maks. udźwig [kg]	pcs / szt.	
74750	1	2	12/192

EN Self-adhesive hanging hooks
 PL Haczyki naścienne samoprzylepne
 DE Selbstklebende Wandhaken
 RU Крючки настенные на липучках
 CS Háčky nástěnné samolepící
 RO Cârîige perete autocolante
 HU Műanyag, fali kampó, öntapadós
 ES Ganchos adhesivos para pared



No.	Max. lifting capacity / Maks. udźwig [kg]	pcs / szt.	
74752	1.2	3	18/216

EN Self-adhesive hanging hooks
 PL Haczyki naścienne samoprzylepne
 DE Selbstklebende Wandhaken
 RU Крючки настенные на липучках
 CS Háčky nástěnné samolepící
 RO Cârlige perete autocolante
 HU Műanyag, fali kampó, öntapadós
 ES Ganchos adhesivos para pared



No.	Max. lifting capacity / Maks. udźwig [kg]	pcs / szt.	
74753	0.4	5	16/288

EN Wall hooks with screws
 PL Haczyki naścienne na wkręt
 DE Wandhaken zum Anschrauben
 RU Крючки настенные на шурупах
 CS Háčky nástěnné na šroub
 RO Cârlige perete cu șurub
 HU Műanyag, fali kampó, csavaros
 ES Ganchos atornillados para pared



No.	Max. lifting capacity / Maks. udźwig [kg]	pcs / szt.	
74766	8	3	12/192

EN Corner cushions
 PL Ochraniacze na narożniki meblowe
 DE Eckenschoner für Möbel
 RU Насадки на углы мебели
 CS Chrániče na rohy nábytku
 RO Protecție colțuri mobilă
 HU Bútor sarokvédő
 ES Protectores esquineros para muebles

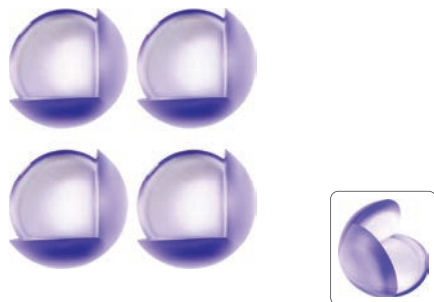

No.	pcs / szt.	
74772	4	16/288

EN Multi-purpose latches
 PL Zabezpieczenie otwarcia drzwi meblowych
 DE Schutzsicherung gegen das Öffnen der Möbeltüren
 RU Блокатор открывания дверей мебели
 CS Pojistka proti otevření nábytkových dveří
 RO Protecție deschidere ușă mobilă
 HU Bútorajtó-űtköző
 ES Protectores para las portezuelas de muebles para prevenir su apertura



No.	pcs / szt.	
74775	2	16/256

EN Wall hooks with screws
 PL Haczyki naścienne na wkręt
 DE Wandhaken zum Anschrauben
 RU Крючки настенные на шурупах
 CS Háčky nástěnné na šroub
 RO Cârlige perete cu șurub
 HU Műanyag, fali kampó, csavaros
 ES Ganchos atornillados para pared



No.	Max. lifting capacity / Maks. udźwig [kg]	pcs / szt.	
74765	5	3	16/256

EN Corner cushions
 PL Ochraniacze na narożniki meblowe
 DE Eckenschoner für Möbel
 RU Насадки на углы мебели
 CS Chrániče na rohy nábytku
 RO Protecție colțuri mobilă
 HU Bútor sarokvédő
 ES Protectores esquineros para muebles



No.	pcs / szt.	
74771	4	16/288

EN Corner cushions
 PL Ochraniacze na narożniki meblowe
 DE Eckenschoner für Möbel
 RU Насадки на углы мебели
 CS Chrániče na rohy nábytku
 RO Protecție colțuri mobilă
 HU Bútor sarokvédő
 ES Protectores esquineros para muebles



No.	pcs / szt.	
74773	4	12/144

EN Multi-purpose latches
 PL Zabezpieczenie otwarcia drzwi meblowych
 DE Schutzsicherung gegen das Öffnen der Möbeltüren
 RU Блокатор открывания дверей мебели
 CS Pojistka proti otevření nábytkových dveří
 RO Protecție deschidere ușă mobilă
 HU Bútorajtó-űtköző
 ES Protectores para las portezuelas de muebles para prevenir su apertura



No.	pcs / szt.	
74776	2	12/216

22

Health & safety products
Artykuły BHP



Gloves Rękawice		378-381
Goggles & shields Okulary i osłony przeciwodpryskowe		381-382
Dust masks Maski przeciwpyłowe		382-383
Welding goggles & masks Okulary i maski spawalnicze		383-386
Knee pads Nakolanniki		386-387
Hearing protectors Nauszniki przeciwhałasowe		387
Safety helmets Kaski ochronne		388

Rain boots Kalosze		388-389
Working shoes Buty robocze		389
Safety sandals Sandaly robocze		389
Shoes accessories Akcesoria do obuwia		389-390
Working clothes Odzież robocza		390-391
Safety vests Kamizelki ostrzegawcze		390
Waterproof jackets Kurtki przeciwdeszczowe		390

EN Working gloves
 PL Rękawice robocze
 DE Arbeitshandschuhe
 RU Рабочие перчатки
 CS Pracovní rukavice
 RO Mănuși de lucru
 HU Védőkesztyű
 ES Guantes de piel



No.	Size / Rozmiar	
74094	8	240

EN Working gloves
 PL Rękawice robocze
 DE Arbeitshandschuhe
 RU Рабочие перчатки
 CS Pracovní rukavice
 RO Mănuși de lucru
 HU Védőkesztyű
 ES Guantes de piel



No.	Size / Rozmiar	
74102	8	10/240

EN Working gloves
 PL Rękawice robocze
 DE Arbeitshandschuhe
 RU Рабочие перчатки
 CS Pracovní rukavice
 RO Mănuși de lucru
 HU Védőkesztyű
 ES Guantes de piel



No.	Size / Rozmiar	
74106	8	10/240

EN Working gloves
 PL Rękawice robocze
 DE Arbeitshandschuh
 RU Перчатки
 CS Pracovní rukavice
 RO Mănuși
 HU Védőkesztyű
 ES Guantes



No.	Size / Rozmiar	
74125	8	12/300
74130	9	12/300
74131	10	12/300

EN Working gloves
 PL Rękawice robocze
 DE Arbeitshandschuhe
 RU Рабочие перчатки
 CS Pracovní rukavice
 RO Mănuși de lucru
 HU Védőkesztyű
 ES Guantes de piel



No.	Size / Rozmiar	
74100	10	12/300

EN Working gloves
 PL Rękawice robocze
 DE Arbeitshandschuhe
 RU Рабочие перчатки
 CS Pracovní rukavice
 RO Mănuși de lucru
 HU Védőkesztyű
 ES Guantes de piel



No.	Size / Rozmiar	
74104	10	10/240

EN Working gloves
 PL Rękawice robocze
 DE Arbeitshandschuhe
 RU Рабочие перчатки
 CS Pracovní rukavice
 RO Mănuși de lucru
 HU Védőkesztyű
 ES Guantes de piel



No.	Size / Rozmiar	
74108	10	240

EN Working gloves
 PL Rękawice robocze
 DE Arbeitshandschuh
 RU Перчатки
 CS Pracovní rukavice
 RO Mănuși
 HU Védőkesztyű
 ES Guantes



No.	Size / Rozmiar	
74126	8	12/300
74132	9	12/300

EN Working gloves
 PL Rękawice robocze
 DE Arbeitshandschuh
 RU Перчатки
 CS Pracovní rukavice
 RO Mănuși
 HU Védőkesztyű
 ES Guantes



No.	Size / Rozmiar	
74128	8	12/300
74136	9	12/300
74137	10	12/300

EN Gardening gloves
 PL Rękawice ogrodnicze
 DE Arbeitshandschuh
 RU Перчатки
 CS Pracovní rukavice
 RO Mănuși
 HU Védőkesztyű
 ES Guantes



No.	Size / Rozmiar	
74121	8	50/1000

EN Gardening gloves
 PL Rękawice ogrodnicze
 DE Arbeitshandschuh
 RU Перчатки
 CS Pracovní rukavice
 RO Mănuși
 HU Védőkesztyű
 ES Guantes



No.	Size / Rozmiar	
74113	8	50/1000

EN Working gloves
 PL Rękawice robocze
 DE Arbeitshandschuh
 RU Перчатки
 CS Pracovní rukavice
 RO Mănuși
 HU Védőkesztyű
 ES Guantes



No.	Size / Rozmiar	
74127	8	12/300
74134	9	12/300
74135	10	12/300

EN Gardening gloves
 PL Rękawice ogrodnicze
 DE Arbeitshandschuh
 RU Перчатки
 CS Pracovní rukavice
 RO Mănuși
 HU Védőkesztyű
 ES Guantes



No.	Size / Rozmiar	
74117	8	50/1000

EN Gardening gloves
 PL Rękawice ogrodnicze
 DE Arbeitshandschuh
 RU Перчатки
 CS Pracovní rukavice
 RO Mănuși
 HU Védőkesztyű
 ES Guantes



No.	Size / Rozmiar	
74123	8	50/1000

EN Gardening gloves
 PL Rękawice ogrodnicze
 DE Arbeitshandschuh
 RU Перчатки
 CS Pracovní rukavice
 RO Mănuși
 HU Védőkesztyű
 ES Guantes



No.	Size / Rozmiar	
74115	8	50/1000

EN Working gloves
 PL Rękawice robocze
 DE Arbeitshandschuhe
 RU Рабочие перчатки
 CS Pracovní rukavice
 RO Mănuși de lucru
 HU Védőkesztyű
 ES Guantes de piel



No.	Size / Rozmiar	
74150	10.5	12/120

EN Working gloves
 PL Rękawice robocze
 DE Arbeitshandschuhe
 RU Рабочие перчатки
 CS Pracovní rukavice
 RO Mănuși de lucru
 HU Védőkesztyű
 ES Guantes de piel

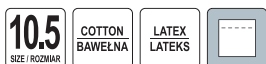

No.	Size / Rozmiar	
74160	10.5	12/120

EN Working gloves
 PL Rękawice robocze
 DE Arbeitshandschuhe
 RU Рабочие перчатки
 CS Pracovní rukavice
 RO Mănuși de lucru
 HU Védőkesztyű
 ES Guantes de piel

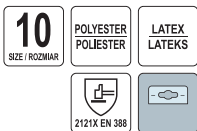

No.	Size / Rozmiar	
74146	10	12/120

EN Working gloves
 PL Rękawice robocze
 DE Arbeitshandschuh
 RU Перчатки
 CS Pracovní rukavice
 RO Mănuși
 HU Védőkesztyű
 ES Guantes



No.	Size / Rozmiar	
74079	9	12/120
74080	10	12/120

EN Working gloves
 PL Rękawice robocze
 DE Arbeitshandschuhe
 RU Рабочие перчатки
 CS Pracovní rukavice
 RO Mănuși de lucru
 HU Védőkesztyű
 ES Guantes de piel



No.	Size / Rozmiar	
74151	9	12/120

EN Working gloves
 PL Rękawice robocze
 DE Arbeitshandschuhe
 RU Рабочие перчатки
 CS Pracovní rukavice
 RO Mănuși de lucru
 HU Védőkesztyű
 ES Guantes de piel



No.	Size / Rozmiar	
74162	9	600

EN Working gloves
 PL Rękawice robocze
 DE Arbeitshandschuhe
 RU Рабочие перчатки
 CS Pracovní rukavice
 RO Mănuși de lucru
 HU Védőkesztyű
 ES Guantes de piel



No.	Size / Rozmiar	Pairs / Pary	
74145	10	12	10

EN Working gloves
 PL Rękawice robocze
 DE Arbeitshandschuh
 RU Перчатки
 CS Pracovní rukavice
 RO Mănuși
 HU Védőkesztyű
 ES Guantes



No.	Size / Rozmiar	Pairs / Pary	
74077	9	12	10
74078	10	12	10

EN Insulated gloves
 PL Rękawice robocze ocieplane
 DE Arbeitshandschuh
 RU Перчатки
 CS Pracovní rukavice
 RO Mănuși
 HU Védőkesztyű
 ES Guantes



No.	Size / Rozmiar	
74149	10	12/120



EN Insulated gloves
 PL Rękawice robocze ocieplane
 DE Arbeitshandschuh
 RU Утепленные перчатки
 CS Zimní rukavice
 RO Mănuși izolate
 HU Szigetelt kesztyű
 ES Guantes aislados



No.	Size / Rozmiar	
74148	10	12/120

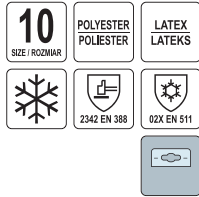

EN Insulated gloves
 PL Rękawice ocieplane
 DE Isolierhandschuhe
 RU Утепленные перчатки
 CS Zimní rukavice
 RO Mănuși izolate
 HU Szigetelt kesztyű
 ES Guantes aislados



No.	Size / Rozmiar	
74003	11	10/120



EN Assembly gloves
 PL Rękawice ochronne
 DE Schutzhandschuhe
 RU Защитные перчатки
 CS Ochranné rukavice
 RO Manuși pt. lucru
 HU Védőkesztyű
 ES Guantes de protección



No.	Size / Rozmiar	
74060	10	10/120



EN Working gloves
 PL Rękawice robocze
 DE Arbeitshandschuh
 RU Перчатки
 CS Pracovní rukavice
 RO Mănuși
 HU Védőkesztyű
 ES Guantes



No.	Size / Rozmiar	
74081	9	12/120
74082	10	12/120



EN Polycarbonate protection shield
 PL Osłona twarzy przeciwdpryskowa
 DE Schutzmaske
 RU Маска защитная
 CS Ochranná přilba
 RO Masca protectie
 HU Hegesztősisak
 ES Pantalla protectora antipedacitos

No.	
74459	25/50



EN Polycarbonate protection shield
 PL Osłona twarzy przeciwdpryskowa
 DE Schutzmaske
 RU Маска защитная
 CS Ochranná přilba
 RO Masca protectie
 HU Hegesztősisak
 ES Pantalla protectora antipedacitos

No.	
74460	20



EN Safety glasses
 PL Okulary ochronne
 DE Schutzbrille
 RU Очки защитные открытые
 CS Ochranné brýle
 RO Ochelari pt. protectie
 HU Védőszemüveg
 ES Gafas protectoras



No.	Type / Typ	
74501	TVS	8/80

EN Safety glasses
 PL Okulary ochronne
 DE Schutzbrille
 RU Очки защитные открытые
 CS Ochranné brýle
 RO Ochelari pt. protectie
 HU Védőszemüveg
 ES Gafas protectoras



No.	Type / Typ	
74503	DY-8525	12/240

EN Safety glasses
 PL Okulary ochronne
 DE Schutzbrille
 RU Очки защитные открытые
 CS Ochranné brýle
 RO Ochelari pt. protectie
 HU Védőszemüveg
 ES Gafas protectoras



No.	Type / Typ	
74508	HF-103	10/120

EN Disposable dust masks
 PL Półmaski filtrujące jednorazowe
 DE Atemschutzmaske
 RU Респиратор противопылевой одноразовый
 CS Protiprašná maska
 RO Masca praf
 HU Eldobható porvédőmaszk
 ES Mascarilla desechable para protección contra polvo



No.	pcs / szt.	
74540	5	50/50

EN Safety glasses
 PL Okulary ochronne
 DE Schutzbrille
 RU Очки защитные открытые
 CS Ochranné brýle
 RO Ochelari pt. protectie
 HU Védőszemüveg
 ES Gafas protectoras



No.	Type / Typ	
74505	STD SG-007	12/240

EN Safety glasses
 PL Okulary ochronne
 DE Schutzbrille
 RU Очки защитные открытые
 CS Ochranné brýle
 RO Ochelari pt. protectie
 HU Védőszemüveg
 ES Gafas protectoras



No.	Type / Typ	
74504	DY-8526	15/150

EN Safety glasses
 PL Okulary ochronne
 DE Schutzbrille
 RU Очки защитные открытые
 CS Ochranné brýle
 RO Ochelari pt. protectie
 HU Védőszemüveg
 ES Gafas protectoras



No.	Type / Typ	
74509	HF-105	10/100

EN Disposable dust masks
 PL Półmaski filtrujące jednorazowe
 DE Atemschutzmaske
 RU Респиратор противопылевой одноразовый
 CS Protiprašná maska
 RO Masca praf
 HU Eldobható porvédőmaszk
 ES Mascarilla desechable para protección contra polvo



No.	pcs / szt.	
74541	5	15/50

EN Disposable dust masks
 PL Półmaski filtrujące jednorazowe
 DE Atemschutzmaske
 RU Респиратор противопылевой одnorазовый
 CS Protiprašná maska
 RO Masca prař
 HU Eldobható porvédőmaszk
 ES Mascarilla desechable para protección contra polvo



5
PCS

FFP1



No.	pcs / szt.	Icon
74542	5	

EN Anti pollution mask
 PL Półmaska antysmogowa
 DE Atemschutzmaske-Smogmaske
 RU Антисмоговая полумаска
 CS Ochranná maska proti znečištění ovzduší
 RO Masca antipoluare
 HU Eldobható porvédőmaszk, szelepes
 ES Mascarilla desechable para



No.	Type / Typ	Icon
74555	antysmogowa, VZ/PZ	

EN Welding goggles
 PL Okulary spawalnicze
 DE Schweisserbrille
 RU Очки газосварщика
 CS Brýle svářečské
 RO Ochelari pt. sudura
 HU Hegesztőszeműveg
 ES Gafas para soldar

TITLED FRAME
UCHYLNA
OPRAWA

DIN 5
FILTER
FILTR

50mm

PROTECTION LENS
SZYBK
OCHRONNA

IMPACT RESISTANT
ODPORNY
NA UDERZENIA

GAS WELDING
SPAWANIE
GAZOWE

GRINDING
SZLIFOWANIE



No.	Icon
74411	

EN Welding mask
 PL Maska spawalnicza
 DE Schweissermaske
 RU Щиток сварщика
 CS Svářečská maska
 RO Mască de sudură
 HU Hegesztőpajzs
 ES Mascara de soldador



DIN 10
FILTER
FILTR

50x100
mm

No.	Type / Typ	Icon
74442	TSM	

EN Disposable dust masks
 PL Półmaski filtrujące jednorazowe
 DE Atemschutzmaske
 RU Респиратор противопылевой одnorазовый
 CS Protiprašná maska
 RO Masca prař
 HU Eldobható porvédőmaszk
 ES Mascarilla desechable para protección contra polvo



5
PCS

FFP1



No.	pcs / szt.	Icon
74543	5	

EN Welding goggles
 PL Okulary spawalnicze
 DE Schweisserbrille
 RU Очки газосварщика
 CS Brýle svářečské
 RO Ochelari pt. sudura
 HU Hegesztőszeműveg
 ES Gafas para soldar

TITLED FRAME
UCHYLNA
OPRAWA

DIN 5
FILTER
FILTR

50mm

PROTECTION LENS
SZYBK
OCHRONNA

IMPACT RESISTANT
ODPORNY
NA UDERZENIA

GAS WELDING
SPAWANIE
GAZOWE

GRINDING
SZLIFOWANIE



No.	Icon
74410	

EN Welding mask
 PL Maska spawalnicza
 DE Schweissermaske
 RU Щиток сварщика
 CS Svářečská maska
 RO Mască de sudură
 HU Hegesztőpajzs
 ES Mascara de soldador



DIN 8
FILTER
FILTR

50x100
mm

No.	Type / Typ	Icon
74440	TSM-3	

EN Welding mask
 PL Przyłbica spawalnicza z podglądem
 DE Schweissermaske
 RU Щиток сварщика с подсмотром
 CS Svářečská přilba s nakoukáváním
 RO Mască de sudură cu geam
 HU Hegesztősisak kitékintővel
 ES Mascara de soldador con mirador



DIN 10
FILTER
FILTR

50x100
mm

No.	Type / Typ	Icon
74443	TSMP	

EN Welding mask
 PL Maska spawalnicza
 DE Schweissmaske
 RU Щиток сварщика
 CS Svářečská maska
 RO Mască de sudură
 HU Hegesztőpajzs
 ES Mascara de soldador



No.	Type / Typ	
74450	TSD-3	20

EN Welding mask
 PL Przyłbica spawalnicza z podglądem
 DE Schweissmaske
 RU Щиток сварщика с подсмотром
 CS Svářečská přilba s nakoukáváním
 RO Mască de sudură cu geam
 HU Hegesztősisak kitékintővel
 ES Mascara de soldador con mirador

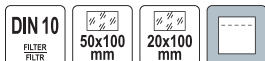

No.	Type / Typ	
74448	PS-3	10

EN Welding mask
 PL Przyłbica spawalnicza
 DE Schweissmaske
 RU Щиток сварщика
 CS Svářečská přilba
 RO Mască de sudură
 HU Hegesztőpajzs
 ES Mascara de soldador



No.		
74457		20

EN Welding mask
 PL Przyłbica spawalnicza z podglądem
 DE Schweissmaske
 RU Щиток сварщика с подсмотром
 CS Svářečská přilba s nakoukáváním
 RO Mască de sudură cu geam
 HU Hegesztősisak kitékintővel
 ES Mascara de soldador con mirador

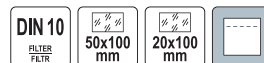

No.	Type / Typ	
74447	PSMP	20

EN Welding mask
 PL Maska spawalnicza
 DE Schweissmaske
 RU Щиток сварщика
 CS Svářečská maska
 RO Mască de sudură
 HU Hegesztőpajzs
 ES Mascara de soldador



No.		
74441		20

EN Auto-darkening welding helmet
 PL Przyłbica spawalnicza samościemniająca
 DE Schweissmaske, selbstverdunkelnd
 RU Маска сварщика с автозатемнением
 CS Svářečská kucka samostmívací
 RO Mască de sudură auto-întunecare
 HU Őnmagától sötétedő hegesztőpajzs
 ES Casco auto-oscurecedor para soldadura

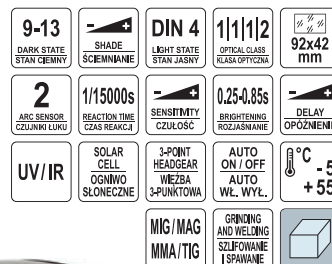

No.		
74480		6

EN Auto-darkening welding helmet
 PL Przyłbica spawalnicza samościemniająca
 DE Schweissmaske, selbstverdunkelnd
 RU Маска сварщика с автозатемнением
 CS Svářečská kukla samostmívací
 RO Mască de sudură auto-întunecare
 HU Őnmagától sötétedő hegesztőpajzs
 ES Casco auto-oscurecedor para soldadura



DIN 11 DARK STATE STAN CIEMNY	DIN 3 LIGHT STATE STAN JASNY	1 1 1 2 OPTICAL CLASS KLASA OPTYCZNA	90x35 mm
2 ARC SENSOR CZUJNIKI ŁUKU	1/25000s REACTION TIME CZAS REAKCJI	0.4 s BRIGHTENING ROZJAŚNIANIE	DIN 15 UV/IR
SOLAR CELL SŁONECZNE	1x CR1028	3-POINT HEADGEAR WIEŻBA 3-PUNKTOWA	°C -5 +55
MIG / MAG MMA / TIG	GRINDING AND WELDING SZLIFOWANIE I SPAWANIE		

STHOR

No.	
74483	6

EN Auto-darkening welding helmet
 PL Przyłbica spawalnicza samościemniająca
 DE Schweissmaske, selbstverdunkelnd
 RU Маска сварщика с автозатемнением
 CS Svářečská kukla samostmívací
 RO Mască de sudură auto-întunecare
 HU Őnmagától sötétedő hegesztőpajzs
 ES Casco auto-oscurecedor para soldadura



DIN 11 DARK STATE STAN CIEMNY	DIN 3 LIGHT STATE STAN JASNY	1 1 1 2 OPTICAL CLASS KLASA OPTYCZNA	100x50 mm	4 ARC SENSOR CZUJNIKI ŁUKU
1/25000s REACTION TIME CZAS REAKCJI	0.1-1.0 s BRIGHTENING ROZJAŚNIANIE	DIN 16 UV/IR	SOLAR CELL SŁONECZNE	2x CR2032
AUTO ON / OFF AUTO WL. WYL.	AUTOMATIC SENSITIVITY ADJUSTMENT AUTOMATYCZNA REGULACJA CZUŁOŚCI	3-POINT HEADGEAR WIEŻBA 3-PUNKTOWA	°C -5 +55	MIG / MAG MMA / TIG
GRINDING AND WELDING SZLIFOWANIE I SPAWANIE				

STHOR

No.	
74484	6

EN Face shield
 PL Osłona siatkowa twarzy z nagłowiem
 DE Gesichtsschutz mit Maschenvisier
 RU Сетчатая защитная маска с обвязкой для головы
 CS Síťová ochrana tváře s postrojem
 RO Vizor protecție față
 HU Hálós arcvédő
 ES Pantalla con visor de malla metálica

PE	STEEL STAL	
-----------	----------------------	--



FLO

No.	
74468	25

EN Face shield with PC visor
 PL Przyłbica z osłoną wymienną
 DE Schweisserschutzhelm mit austauschbarer Abdeckung
 RU Шлем с заменяемой защитой
 CS Štít s vyměnitelným krytem
 RO Vizieră cu protecție schimbabilă
 HU Arcvédő cserélhető pajzsral
 ES Antifaz con protección reemplazable

	1 OPTICAL CLASS KLASA OPTYCZNA
395x200 mm	PE
PVC	



VOREL

No.	
74471	25

EN Face shield with steel mesh and ear muff
 PL Przyłbica z osłoną wymienną i nausznikami przeciwhałasowymi
 DE Schweisserschutzhelm mit austauschbarer Abdeckung und Ohrenschützer gegen Lärm
 RU Шлем с заменяемой защитой и наушниками против шума
 CS Štít s vyměnitelným krytem a chrániči proti hluku
 RO Vizieră cu protecție schimbabilă și căști de protecție antigzgomot
 HU Arcvédő cserélhető pajzsral és fülvédő kagylóval
 ES Antifaz con protección reemplazable y protectores de oídos

	395x200 mm	
--	----------------------	--



VOREL

No.	
74462	40

- EN Filter shield
- PL Oslona filtra
- DE Filterabdeckung
- RU Кожух фильтра
- CS Ochrana filtru
- RO Aparatoare de filtru
- HU Szűrőfedél
- ES Protección de filtro



No.	Filter size / Rozmiar filtra [mm]	Dark state / Stan ciemny [DIN]	
74451	50x100	0	100

- EN Filter protection
- PL Oslona filtra
- DE Filtereinsatz
- RU Кожух фильтра
- CS Ochranná folie filtru
- RO Carcasă filtru
- HU Szűrő-védőburkolat
- ES Protección del filtro



No.	Size / Rozmiar [mm]	Type / Typ	For / Dia	
74466	350x200	OT 1-N	74460	10/100

- EN Knee pads
- PL Nakolanniki
- DE Knieschützer
- RU Наколенники
- CS Chrániče kolen
- RO Genunchiere
- HU Térdvédő
- ES Rodilleras



No.	
74600	50

- EN Knee pads
- PL Nakolanniki
- DE Knieschützer
- RU Наколенники
- CS Chrániče kolen
- RO Genunchiere
- HU Térdvédő
- ES Rodilleras



No.	
74622	50

- EN Welding filter
- PL Filtr spawalniczy
- DE Vorsatzglas
- RU Фильтр для сварки
- CS Filtr svářečský
- RO Filtru pt. sudării
- HU Hegesztőszűrő
- ES Pantalla de filtro de soldador



No.	Filter size / Rozmiar filtra [mm]	Dark state / Stan ciemny [DIN]	
74452	50x100	8	100
74453	50x100	9	100
74454	50x100	10	100
74455	50x100	11	100

- EN Self-dimming helmet filter protection
- PL Oslona filtra przyłbicy samościemniającej
- DE Filtereinsatz eines selbstabdunkelnden Schutzhelmes
- RU Кожух фильтра самозатемняющегося шлёмка
- CS Ochranná folie filtru samostrmivací kukly
- RO Carcasă filtru vizieră heliomată
- HU Hegesztőpajzs szűrő, önsötétedő
- ES Protección del filtro de visera autooscurecedora



No.	Filter size / Rozmiar filtra [mm]	pcs / szt.	
74439	90x110	5	20

- EN Knee pads
- PL Nakolanniki
- DE Knieschützer
- RU Наколенники
- CS Chrániče kolen
- RO Genunchiere
- HU Térdvédő
- ES Rodilleras



No.	
74610	20

- EN Knee pads
- PL Nakolanniki
- DE Knieschützer
- RU Наколенники
- CS Chrániče kolen
- RO Genunchiere
- HU Térdvédő
- ES Rodilleras



No.	
74624	12/24



EN Knee pads
 PL Nakolanniki
 DE Knieschützer
 RU Наколенники
 CS Chrániče kolen
 RO Genunchiere
 HU Térdvédő
 ES Rodilleras

PE EPE OXFORD 600D POLYESTER POLYESTER



No. 74601 24

EN Knee pads
 PL Nakolanniki
 DE Knieschützer
 RU Наколенники
 CS Chrániče kolen
 RO Genunchiere
 HU Térdvédő
 ES Rodilleras

EVA PP OXFORD 600D POLYESTER POLYESTER



No. 74603 6/24

EN Knee pads
 PL Nakolanniki - wkładki
 DE Knieschützer
 RU Наколенники
 CS Chrániče kolen
 RO Genunchiere
 HU Térdvédő
 ES Rodilleras

210x165 x18 mm EVA



No. 74595 60

EN Hearing protectors
 PL Nauszniki przeciwhałasowe
 DE Gehörschutz
 RU Средства защиты слуха
 CS Chrániče sluchu
 RO Antifoane
 HU Fültok
 ES Protectores auditivos



No. 74581 10/60

EN Knee pads
 PL Nakolanniki
 DE Knieschützer
 RU Наколенники
 CS Chrániče kolen
 RO Genunchiere
 HU Térdvédő
 ES Rodilleras

EVA PE OXFORD 600D POLYESTER POLYESTER



No. 74602 6/36

EN Knee pads
 PL Nakolanniki
 DE Knieschützer
 RU Наколенники
 CS Chrániče kolen
 RO Genunchiere
 HU Térdvédő
 ES Rodilleras

PE 600D POLYESTER POLYESTER



No. 74604 20

EN Hearing protectors
 PL Nauszniki przeciwhałasowe
 DE Gehörschutz
 RU Средства защиты слуха
 CS Chrániče sluchu
 RO Antifoane
 HU Fültok
 ES Protectores auditivos

SNR 24dB



No. 74580 60

EN Hearing protectors
 PL Nauszniki przeciwhałasowe
 DE Gehörschutz
 RU Средства защиты слуха
 CS Chrániče sluchu
 RO Antifoane
 HU Fültok
 ES Protectores auditivos

SNR 20.4dB



EN Safety helmet
 PL Kask ochronny
 DE Schutzhelm
 RU Каска защитная
 CS Ochranná přilba
 RO Cască de protecție
 HU Védősisak
 ES Casco de protección



VOREL

No.	Color / Kolor	
74171	pomarańczowy	30
74172	zółty	30
74173	biały	30
74174	czerwony	30
74175	niebieski	30
74176	zielony	30

EN Women's rain boots
 PL Kalosze damskie
 DE Damen - Gummistiefel
 RU Галоши женские
 CS Dámské galoše
 RO Cizme damă
 HU Női gumicsizma
 ES Chanclos para mujer



VOREL

No.	Size / Rozmiar	
73931	36	7
73932	37	7
73933	38	7
73934	39	7
73935	40	7
73936	41	7

EN Women's rain boots
 PL Kalosze damskie
 DE Damen - Gummistiefel
 RU Галоши женские
 CS Dámské galoše
 RO Cizme damă
 HU Női gumicsizma
 ES Chanclos para mujer



VOREL

No.	Size / Rozmiar	
73945	37	5
73946	38	5
73947	39	5

EN Safety helmet
 PL Kask ochronny
 DE Schutzhelm
 RU Каска защитная
 CS Ochranná přilba
 RO Cască de protecție
 HU Védősisak
 ES Casco de protección



VOREL

No.	Color / Kolor	
74190	biały	40
74191	czerwony	40
74192	niebieski	40
74193	zółty	40
74194	pomarańczowy	40
74195	zielony	40

EN Men's rain boots
 PL Kalosze męskie
 DE Herren - Gummistiefel
 RU Галоши мужские
 CS Pánské galoše
 RO Cizme bărbăți
 HU Férfi gumicsizma
 ES Chanclos para hombre



VOREL

No.	Size / Rozmiar	
73937	41	5
73938	42	5
73939	43	5
73940	44	5
73941	45	5
73942	46	5
73943	47	5

EN Men's rain boots
 PL Kalosze męskie
 DE Herren - Gummistiefel
 RU Галоши мужские
 CS Pánské galoše
 RO Cizme bărbăți
 HU Férfi gumicsizma
 ES Chanclos para hombre



VOREL

No.	Size / Rozmiar	
73950	41	5
73951	42	5
73952	43	5
73953	44	5
73954	45	5
73955	46	5

EN Felt PVC boots
 PL Buty gumowo-filcowe
 DE Gummistiefel mit Filz
 RU Сапоги резиновые с войлоком
 CS Holínky s filcem
 RO Cizme PVC
 HU Gumi - filc csizma
 ES Botas de goma fieltro



No.	Size / Rozmiar	
73958	40	5
73959	41	5
73960	42	5
73961	43	5
73962	44	5
73963	45	5
73964	46	5

EN Safety sandals
 PL Sandały robocze
 DE Arbeitshalbschuhe
 RU Полуботинки рабочие
 CS Pracovní polobotky
 RO Vocanci de lucru
 HU Munkavédelmi félcipő
 ES Zapato de trabajo



No.	Size / Rozmiar	Series / Seria	
72801	39	SALTA	10
72802	40	SALTA	10
72803	41	SALTA	10
72804	42	SALTA	10
72805	43	SALTA	10
72806	44	SALTA	10
72807	45	SALTA	10
72808	46	SALTA	10
72809	47	SALTA	10

EN Oil spray
 PL Płynny tłuszcz do obuwia
 DE Wartungs-Spray Schuhe
 RU Жидкий жир для обуви
 CS Olejový spray na obuv
 RO Spray intrinere incaltaminte
 HU Cipőpoló olaj
 ES Aceite para botas



No.	Capacity / Pojemność [ml]	
72890	150	20

EN Men's rain boots
 PL Kalosze męskie
 DE Herren - Gummistiefel
 RU Галоши мужские
 CS Pánské galoše
 RO Cizme bărbați
 HU Férfi gumicsizma
 ES Chanclos para hombre



No.	Size / Rozmiar	
73966	40	5
73967	41	5
73968	42	5
73969	43	5
73970	44	5
73971	45	5
73972	46	5
73973	47	5

EN Safety sandals
 PL Sandały robocze
 DE Arbeitshalbschuhe
 RU Полуботинки рабочие
 CS Pracovní polobotky
 RO Vocanci de lucru
 HU Munkavédelmi félcipő
 ES Zapato de trabajo

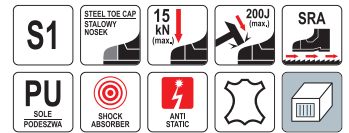

No.	Size / Rozmiar	Series / Seria	
72821	39	SERRA	10
72822	40	SERRA	10
72823	41	SERRA	10
72824	42	SERRA	10
72825	43	SERRA	10
72826	44	SERRA	10
72827	45	SERRA	10
72828	46	SERRA	10
72829	47	SERRA	10

EN Ravvivant spray
 PL Spray ożywiający kolor do nubuku i zamszu
 DE Wildleder und Nubuk Pflegespray
 RU Спрей освежающий цвет nubука и замши
 CS Spray na semišovou obuv
 RO Spray revitalizant incaltaminte
 HU Nubukvelourápoló spray
 ES Spray para suede



No.	Capacity / Pojemność [ml]	
72891	250	20

- EN Antibacterial insole
- PL Antybakteryjna wkładka do butów
- DE Antibakterielle Einlage für Schuhe
- RU Антибактериальная стелька
- CS Antibakteriální vložka do bot
- RO Tălpici antibacterieni
- HU Antibakteriális cipőbetét
- ES Plantilla antibacterial



No.	Size / Rozmiar	Thickness / Grubość [mm]	
72683	39/40	3.2	50
72684	41/42	3.2	50
72685	43/44	3.2	50
72686	45/46	3.2	50

- EN Reflective vest
- PL Kamizelka ostrzegawcza
- DE Warnweste
- RU Жилет безопасности
- CS Výstražná vesta
- RO Vestă de avertizare
- HU Fényvisszaverő mellény
- ES chaleco reflectante



100% polyester

100% poliester



No.	Size / Rozmiar	Series / Seria	
74664	L	VEST-G	100
74665	XL	VEST-G	100
74666	XXL	VEST-G	100
74667	XXXL	VEST-G	100

- EN Raincoat
- PL Płaszcz przeciwdeszczowy
- DE Regenmantel
- RU Дождевик
- CS Pláštěnka
- RO Pelerina ploaie
- HU Esőkabát
- ES Impermeable



No.	Size / Rozmiar	
74653	L	20
74654	XL	20
74655	XXL	20

- EN Reflective vest
- PL Kamizelka ostrzegawcza
- DE Warnweste
- RU Жилет безопасности
- CS Výstražná vesta
- RO Vestă de avertizare
- HU Fényvisszaverő mellény
- ES chaleco reflectante



100% polyester

100% poliester



No.	Size / Rozmiar	Series / Seria	
74660	L	VEST-0	100
74661	XL	VEST-0	100
74662	XXL	VEST-0	100
74663	XXXL	VEST-0	100

- EN Waterproof jacket
- PL Kurtka przeciwdeszczowa
- DE Regenjacke
- RU Куртка-дождевик
- CS Bunda do deště
- RO Giacă impermeabilă
- HU Vízhatalan dzseki
- ES Chaqueta impermeable



70% PVC, 30% polyester

70% PVC, 30% poliester



No.	Size / Rozmiar	
74626	L	20
74627	XXL	20
74628	XXXL	20

- EN Raincoat
- PL Płaszcz przeciwdeszczowy
- DE Regenmantel
- RU Дождевик
- CS Pláštěnka
- RO Pelerina ploaie
- HU Esőkabát
- ES Impermeable



70% PVC, 30% polyester

70% PVC, 30% poliester



No.	Size / Rozmiar	
74631	XL	10
74632	XXL	10
74633	XXXL	10

23

Electric products
Artykuły elektryczne



Extension cords & cable reels Przedłużacze listwowe i bębnowe

394-396



Extension cords French type

Przedłużacze elektryczne z uziemieniem..... 394

Extension cords

Przedłużacze elektryczne bez uziemienia..... 395

Christmas tree extension cables

Przedłużacze choinkowe..... 396

Cable reels French type

Przedłużacze bębnowe z uziemieniem..... 396

Adaptors Rozgałęźniki

397



Lamps Lampy

397-403



Halogen bulbs

Żarniki do lamp halogenowych..... 397

LED floodlights

Naświetlacze LED..... 397

Workshop lamps

Lampy warsztatowe..... 398

LED flashlights

Latarki diodowe..... 401

Hats with LED lamp

Czapki z lampką..... 402

Bicycle lamps

Lampy rowerowe..... 403

Night lamps

Lampki nocne..... 403

Motion detectors Czujniki ruchu

404



EN Surge protector power strip
 PL Listwa zasilająca przeciwprzebieciowa
 DE Überspannungsschutzleiste
 RU Колодка электрическая с защитой от перенапряжения
 CS Prodlužovací kabel s přepětovou ochranou
 RO Prelungitor cu protectie
 HU Túlfeszültségvédő elosztó
 ES Regleta de protección contra sobretensiones

230V~50Hz 16 A 3x 1.5 mm² CABLE H05VV-F KABEL

3 m ON / OFF OVERHEAT PROTECTION BEZPEČENÍ PŘED DĚJENÍM

CHILDREN PROTECTION ZABEZPEČENÍ PŘED DĚJENÍM E E/F



STKOR

No.	L [m]	☺	Socket type / Typ gniazda	📦
72370	3	5	E	30
72371	3	6	E	20

EN Surge protector power strip
 PL Listwa zasilająca przeciwprzebieciowa
 DE Überspannungsschutzleiste
 RU Колодка электрическая с защитой от перенапряжения
 CS Prodlužovací kabel s přepětovou ochranou
 RO Prelungitor cu protectie
 HU Túlfeszültségvédő elosztó
 ES Regleta de protección contra sobretensiones

230V~50Hz 16 A 3x 1.5 mm² CABLE H05VV-F KABEL

3 m ON / OFF OVERHEAT PROTECTION BEZPEČENÍ PŘED DĚJENÍM

CHILDREN PROTECTION ZABEZPEČENÍ PŘED DĚJENÍM E E/F



STKOR

No.	L [m]	☺	Socket type / Typ gniazda	📦
72372	3	5	E	30
72373	3	6	E	20

EN Extension cord
 PL Przedłużacz elektryczny
 DE Verlängerungskabel
 RU Удлинитель электрический
 CS Elektrický prodlužovač
 RO Prelungitor electric
 HU Elektromos hosszabbító
 ES Extensión eléctrica

230V~50Hz 16 A 3x 1.0 mm² CABLE H05VV-F KABEL 2 m ON / OFF CHILDREN PROTECTION ZABEZPEČENÍ PŘED DĚJENÍM E E/F



LUND

No.	L [m]	☺	Socket type / Typ gniazda	📦
72460	2	5	E	25

EN Extension cord
 PL Przedłużacz elektryczny
 DE Verlängerungskabel
 RU Удлинитель электрический
 CS Elektrický prodlužovač
 RO Prelungitor electric
 HU Elektromos hosszabbító
 ES Extensión eléctrica

230V~50Hz 16 A 3x 1.5 mm² CABLE H05VV-F KABEL

ON / OFF CHILDREN PROTECTION ZABEZPEČENÍ PŘED DĚJENÍM E E/F



STKOR

No.	L [m]	☺	Socket type / Typ gniazda	📦
72350	1.5	3	E	40
72351	3.0	3	E	40
72352	5.0	3	E	30
72353	1.5	4	E	30
72354	3.0	4	E	30
72355	5.0	4	E	20
72356	1.5	5	E	30
72357	3.0	5	E	30
72358	5.0	5	E	20

EN Cord extension with earthing
 PL Przedłużacz elektryczny z uzziemieniem
 DE Tischsteckdose Bolzenanschl
 RU Удлинитель электрический с заземлением
 CS Elektrický prodlužovač
 RO Prelungitor electric
 HU Elektromos hosszabbító
 ES Extensión electr.

230V~50Hz 3x 1.0 mm² CABLE H05VV-F KABEL E



VOREL

No.	L [m]	☺	Socket type / Typ gniazda	📦
72500	1.5	3	E	12/48
72501	1.5	4	E	12/48
72504	3.0	3	E	12/48
72505	3.0	4	E	12/48
72506	3.0	5	E	12/48
72508	5.0	3	E	12/48
72509	5.0	4	E	12/48
72510	5.0	5	E	12/48

EN Cord extension with earthing
 PL Przedłużacz elektryczny z uziemieniem
 DE Tischsteckdose Bolzenanschl
 RU Удлинитель электрический с заземлением
 CS Elektrický prodloužovač
 RO Prelungitor electric
 HU Elektromos hosszabbító
 ES Extensión electr.

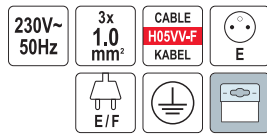

No.	L [m]	☺	Socket type / Typ gniazda	📦
72615	1.5	3	E	12/48
72616	3.0	3	E	12/48
72617	5.0	3	E	12/48
72620	1.5	4	E	12/48
72621	3.0	4	E	12/48
72622	5.0	4	E	12/48

EN Cord extension with earthing
 PL Przedłużacz elektryczny z uziemieniem
 DE Tischsteckdose Bolzenanschl
 RU Удлинитель электрический с заземлением
 CS Elektrický prodloužovač
 RO Prelungitor electric
 HU Elektromos hosszabbító
 ES Extensión electr.

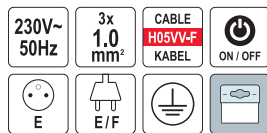

No.	L [m]	☺	Socket type / Typ gniazda	📦
72625	1.5	3	E	12/48
72626	3.0	3	E	12/48
72627	5.0	3	E	12/48
72630	1.5	4	E	12/48
72631	3.0	4	E	12/48
72632	5.0	4	E	12/48

EN Cord extension with switch
 PL Przedłużacz elektryczny z wyłącznikiem
 DE Tischsteckdose
 RU Удлинитель электрический с выключателем
 CS Elektrický prodloužovač
 RO Prelungitor electric
 HU Elektromos hosszabbító
 ES Extensión para arbol de navidad verde

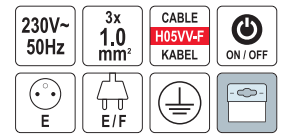

No.	L [m]	☺	Socket type / Typ gniazda	📦
72524	1.5	3	E	12/48
72525	1.5	4	E	12/48
72526	1.5	5	E	12/48
72527	1.5	6	E	12/48
72528	3.0	3	E	12/48
72529	3.0	4	E	12/48
72530	3.0	5	E	12/48
72531	3.0	6	E	12/48
72532	5.0	3	E	12/48
72533	5.0	4	E	12/48
72534	5.0	5	E	12/48
72535	5.0	6	E	12/48

EN Cord extension without earthing
 PL Przedłużacz elektryczny bez uziemienia
 DE Tischsteckdose ohne Nulleitung
 RU Удлинитель электрический без заземления

CS Elektrický prodloužovač
 RO Prelungitor electric
 HU Elektromos hosszabbító
 ES Extensión electr.

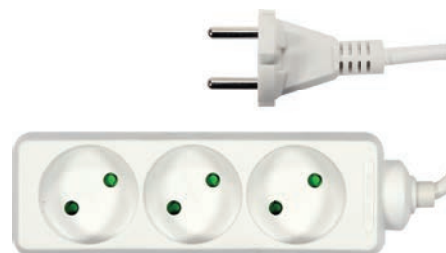
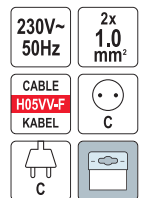

No.	L [m]	☺	Socket type / Typ gniazda	📦
72484	1.5	3	C	12/48
72486	1.5	4	C	12/48
72489	3.0	3	C	12/48
72490	3.0	4	C	12/48
72493	5.0	3	C	12/48
72494	5.0	4	C	12/48

- EN Garden extension cable
 PL Przedłużacz
 DE Gartenverlängerungskabel
 RU Электроудлинитель
- CS Prodlužovací kabel zahradní
 RO Prelungitor electric
 HU Kerti hosszabbító
 ES Cable de extensión para jardín

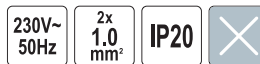

No.	L [m]	
82671	10	10
82673	20	10
82675	30	5
82677	40	5

- EN Christmas tree extension cable
 PL Przedłużacz zielony
 DE Christbaum Verlängerungskabel
 RU Удлинитель
 CS Elektrický prodloužovač
 RO Prelungitor electric
 HU Elektromos hosszabbító
 ES Extensión para árbol de navidad verde



No.	L [m]	
72451	3	10
72452	5	10/10

- EN Cable reel
 PL Przedłużacz bębnowy
 DE Kabeltrommel
 RU Удлинитель на катушке
 RO Prelungitor pe tambur
 HU Kábeldob
 ES Cable de prolongación de tambor

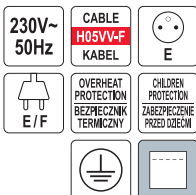

No.	L [m]	Wire section area / Pole przekroju przewodu [mm²]		Socket type / Typ gniazda	
82682	25	3Gx1.0	4	E	2
82684	40	3Gx1.0	4	E	2
82685	50	3Gx1.5	4	E	2



- EN Cable reel
 PL Przedłużacz zwijany
 DE Kabeltrommel Bolzenanschl
 RU Удлинитель электрический
 CS Bubnový prodloužovač
 RO Prelungitor pe tambur
 HU Kábeldob
 ES Extensión electr.

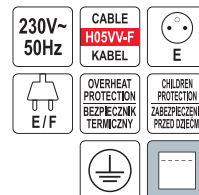

VOREL

No.	L [m]	Wire section area / Pole przekroju przewodu [mm²]		Socket type / Typ gniazda	
72570	15	3Gx1.0	4	E	4
72572	25	3Gx1.0	4	E	4
72573	30	3Gx1.5	4	E	4

- EN Cable reel
 PL Przedłużacz bębnowy
 DE Kabeltrommel
 RU Удлинитель на катушке
 RO Bubnový prodloužovač
 RO Prelungitor pe tambur
 HU Kábeldob
 ES Cable de prolongación de tambor

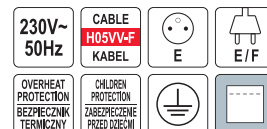

STHOR

No.	L [m]	Wire section area / Pole przekroju przewodu [mm²]		Socket type / Typ gniazda	
82691	15	3Gx1.0	4	E	4
82692	25	3Gx1.0	4	E	2
82693	40	3Gx1.0	4	E	1
82694	50	3Gx1.5	4	E	1





EN Adapter
 PL Rozgałęźnik
 DE Abzweigung
 RU Разветвитель
 CS Rozdvojka
 RO Splitter
 HU Osztó
 ES Enchufe múltiple

230V~
50Hz

16
A





No.		Socket type / Typ gniazda	
72404	2	E	100

EN Adapter
 PL Rozgałęźnik
 DE Abzweigung
 RU Разветвитель
 CS Rozdvojka
 RO Splitter
 HU Osztó
 ES Enchufe múltiple

230V~
50Hz

2.5
A



No.		Socket type / Typ gniazda	
72400	2	C	200
72401	3	C	20/100
72402	4	C	100

EN LED lamp with motion detector
 PL Reflektor diodowy z czujnikiem ruchu
 DE Diodescheinwerfer mit Bewegungsmelder
 RU Светодиодный прожектор с датчиком движения
 CS LED reflektor se snímačem pohybu
 RO Reflector diodă cu senzor de mișcare
 HU Diódás reflektor mozgásérzékelővel
 ES Reflector de diodos con sensor de movimiento

10
W

6000K

800
lm

230V~
50Hz

 25000 h

IP54

 10m





No.	Power / Moc [W]	Luminous flux / Strumień świetlny [lm]	Lifetime / Żywotność [h]	
82845	10	800	25000	12

EN Adapter
 PL Rozgałęźnik
 DE Abzweigung
 RU Разветвитель
 CS Rozdvojka
 RO Splitter
 HU Osztó
 ES Enchufe múltiple

230V~
50Hz

16
A





No.		Socket type / Typ gniazda	
72407	3	E	100

GB Halogen projector bulbs
 PL Żarniki do lamp halogenowych
 DE Halogenstab
 RU Галогенная трубка
 CZ Žárovka do halogenové lampy
 RO Bec cu halogen pt. proiector
 HU Halogén lámpaizzó
 ES Filamentos de bombillas halogenas

2
PCS

R7s



No.	Filament power / Moc żarnika halogenowego [W]	Luminous flux / Strumień świetlny [lm]	Lifetime / Żywotność [h]	
82771	120	2200	1000	50/200
82772	400	8600	1000	50/200

EN LED lamp with motion detector
 PL Reflektor diodowy z czujnikiem ruchu
 DE Diodescheinwerfer mit Bewegungsmelder
 RU Светодиодный прожектор с датчиком движения
 CS LED reflektor se snímačem pohybu
 RO Reflector diodă cu senzor de mișcare
 HU Diódás reflektor mozgásérzékelővel
 ES Reflector de diodos con sensor de movimiento

20
W

6000K

1600
lm

230V~
50Hz

 25000 h

IP54

 10m



No.	Power / Moc [W]	Luminous flux / Strumień świetlny [lm]	Lifetime / Żywotność [h]	
82846	20	1600	25000	12

- EN LED lamp with motion detector
- PL Reflektor diodowy z czujnikiem ruchu
- DE Diodenscheinwerfer mit Bewegungsmelder
- RU Светодиодный прожектор с датчиком движения
- CS LED reflektor se snímačem pohybu
- RO Reflector diodă cu senzor de mișcare
- HU Diódás reflektor mozgásérzékelővel
- ES Reflector de diodos con sensor de movimiento

30 W	6000K	2400 lm	230V~50Hz
25000 h	IP54	10m	



SMD LED



No.	Power / Moc [W]	Luminous flux / Strumień świetny [lm]	Lifetime / Żywotność [h]	
82847	30	2400	25000	12

- EN Rechargeable work lamp
- PL Diodowa lampa bezprzewodowa
- DE Led Werkstattlampe
- RU Светодиодная беспроводная лампа
- CS Montážní lampa diodová bezpřívodová
- RO Lampa cu led fara cablu
- HU Ledlámpa
- ES Lámpara inalámbrica de diodos

12 LED	200 lm	4h	4.5h
12 V 2000mAh Li-Ion	230V~50Hz BATTERY CHARGER LADONARKA	12V BATTERY CHARGER LADONARKA	x1 HOOK HAK



SMD LED



No.	Light source / Źródło światła [LED]	Battery capacity / Pojemność akumulatora [mAh]	
82728	12	2000	20

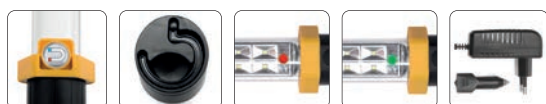

- EN LED work light
- PL Lampa robocza LED
- DE LED Handleuchte
- RU Светодиодный светильник для мастерской
- CS Ruční svítidla LED
- RO Lampa portabila cu LED
- HU LED lámpa
- ES Lámpara de taller LED



3W	100 lm	2 LIGHTING MODES TŘEBY SVĚTLENÍ	4h	3.7 V 800mAh Li-Ion
Micro USB	x1 HOOK HAK			



No.	Power / Moc [W]	Battery capacity / Pojemność akumulatora [mAh]	
82723	3	800	12/48



COB LED

- EN LED lamp with motion detector
- PL Reflektor diodowy z czujnikiem ruchu
- DE Diodenscheinwerfer mit Bewegungsmelder
- RU Светодиодный прожектор с датчиком движения
- CS LED reflektor se snímačem pohybu
- RO Reflector diodă cu senzor de mișcare
- HU Diódás reflektor mozgásérzékelővel
- ES Reflector de diodos con sensor de movimiento

50 W	6000K	4000 lm	230V~50Hz
25000 h	IP54	10m	



SMD LED



No.	Power / Moc [W]	Luminous flux / Strumień świetny [lm]	Lifetime / Żywotność [h]	
82848	50	4000	25000	12

- EN Rechargeable work lamp
- PL Diodowa lampa bezprzewodowa
- DE Led Werkstattlampe
- RU Светодиодная беспроводная лампа
- CS Montážní lampa diodová bezpřívodová
- RO Lampa cu led fara cablu
- HU Ledlámpa
- ES Lámpara inalámbrica de diodos

FRONT LIGHT LATARKA	3W	200 lm
3.7 V 2000mAh Li-Ion	230V~50Hz BATTERY CHARGER LADONARKA	12V BATTERY CHARGER LADONARKA
4h	4h	x1 HOOK HAK



COB LED



No.	Light source / Źródło światła [LED]	Battery capacity / Pojemność akumulatora [mAh]	
82719	1+3	2000	20



EN LED work light
 PL Lampa robocza LED
 DE LED Handleuchte
 RU Светодиодный светильник для мастерской
 CS Ruční svítlna LED
 RO Lampa portabila cu LED
 HU LED lámpa
 ES Lámpara de taller LED

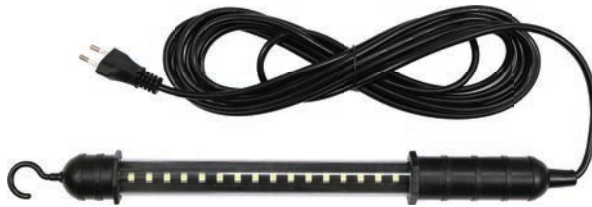

230V~50Hz 3.2 W 280 lm 16 LED
 x1 HOOK HAK 5m



No.	Power / Moc [W]	Light source / Źródło światła [LED]	
82699	3.2	16	10/20

EN LED work light
 PL Lampa robocza LED
 DE LED Handleuchte
 RU Светодиодный светильник для мастерской
 CS Ruční svítlna LED
 RO Lampa portabila cu LED
 HU LED lámpa
 ES Lámpara de taller LED

230V~50Hz 4.5 W 400 lm 24 LED
 x1 HOOK HAK 5m



No.	Power / Moc [W]	Light source / Źródło światła [LED]	
82706	4.5	24	10/20

EN Work light
 PL Lampa warsztatowa
 DE Werkstattlampe
 RU Лампа-переноска
 CS Pracovní lampa
 RO Lampă pt. atelier
 HU Szerelőlámpa
 ES Lámpara de taller

230V~50Hz 60 W E27 5m



No.	Max. power of light source / Maks. moc źródła światła [W]	Series / Seria	
82715	60	PLASTIC	10

EN Work light
 PL Lampa warsztatowa
 DE Werkstattlampe
 RU Лампа-переноска
 CS Pracovní lampa
 RO Lampă pt. atelier
 HU Szerelőlámpa
 ES Lámpara de taller

230V~50Hz E27 5m



No.	Max. power of light source / Maks. moc źródła światła [W]	Series / Seria	
82716	60	GUMMI	10
82717	100	GUMMI	10

EN Work light
 PL Lampa warsztatowa
 DE Werkstattlampe
 RU Лампа-переноска
 CS Pracovní lampa
 RO Lampă pt. atelier
 HU Szerelőlámpa
 ES Lámpara de taller

230V~50Hz 100 W E27 5m



No.	Max. power of light source / Maks. moc źródła światła [W]	Series / Seria	
82713	100	PRACTIC	10

EN Work light
 PL Lampa warsztatowa
 DE Werkstattlampe
 RU Лампа-переноска
 CS Pracovní lampa
 RO Lampă pt. atelier
 HU Szerelőlámpa
 ES Lámpara de taller

230V~50Hz 60 W E27 5m



No.	Max. power of light source / Maks. moc źródła światła [W]	Series / Seria	
82714	60	CLASSIC	10

EN Rechargeable LED work light
 PL Lampa robocza akumulatorowa LED
 DE LED Akku-Handleuchte
 RU Аккумуляторный светодиодный светильник для мастерской
 CS Ruční svítlna LED
 RO Lampa portabila cu acumulator leduri
 HU Ledes szerelőlámpa cirkéjú cikkek
 ES Linterna LED recargable

3+3 W 3.7 V 600mAh Li-Ion 300/100 lm
 2h 3-4h IP54



No.	Power / Moc [W]	Battery capacity / Pojemność akumulatora [mAh]	
82734	3+3	600	120

EN LED work light
 PL Lampa robocza LED
 DE LED Handleuchte
 RU Светодиодный светильник для мастерской
 CS Ruční svítlna LED
 RO Lampa portabila cu LED
 HU LED lámpa
 ES Lámpara de taller LED



COB
LED



No.	Battery type / Rodzaj baterii	
82724	3x1.5V; AAA	12/48

EN LED work light
 PL Lampa robocza LED
 DE LED Handleuchte
 RU Светодиодный светильник для мастерской
 CS Ruční svítlna LED
 RO Lampa portabila cu LED
 HU LED lámpa
 ES Lámpara de taller LED

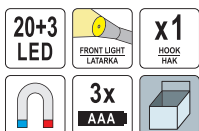

SMD
LED



No.	Light source / Źródło światła [LED]	Battery type / Rodzaj baterii	
82730	20+3	3x1.5V; AAA	12/48

EN LED work light
 PL Lampa robocza LED
 DE LED Handleuchte
 RU Светодиодный светильник для мастерской
 CS Ruční svítlna LED
 RO Lampa portabila cu LED
 HU LED lámpa
 ES Lámpara de taller LED

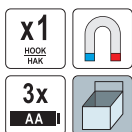

COB
LED



No.	Battery type / Rodzaj baterii	
82726	3x1.5V; AA	12/48

EN LED work light
 PL Lampa robocza LED
 DE LED Handleuchte
 RU Светодиодный светильник для мастерской
 CS Ruční svítlna LED
 RO Lampa portabila cu LED
 HU LED lámpa
 ES Lámpara de taller LED



COB
LED



No.	Battery type / Rodzaj baterii	
82733	3x1.5V; AAA	24/48

EN LED work light
 PL Lampa robocza LED
 DE LED Handleuchte
 RU Светодиодный светильник для мастерской
 CS Ruční svítlna LED
 RO Lampa portabila cu LED
 HU LED lámpa
 ES Lámpara de taller LED

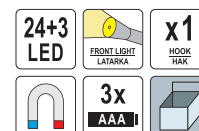

SMD
LED



No.	Light source / Źródło światła [LED]	Battery type / Rodzaj baterii	
82731	24+3	3x1.5V; AAA	12/48

EN LED work light
 PL Lampa robocza LED
 DE LED Handleuchte
 RU Светодиодный светильник для мастерской
 CS Ruční svítlna LED
 RO Lampa portabila cu LED
 HU LED lámpa
 ES Lámpara de taller LED



LED



No.	Light source / Źródło światła [LED]	Battery type / Rodzaj baterii	
82735	36+1	4x1.5V; AAA	12/48

EN LED magnetic pick up tool
 PL Chwytnak teleskopowy LED
 DE LED Magnet Heber
 RU Захват магнитный телескопический с подсветкой
 CS Patka magnetická teleskopická LED
 RO Telescop magnetic cu LED
 HU LED felszedő mágnes teleszkópos nyéllel
 ES Herramienta para levantar, telescópica, con LED

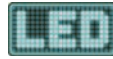
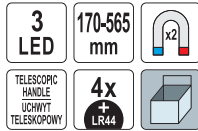

No.	Light source / Źródło światła [LED]	Battery type / Rodzaj baterii	Box
78405	3	4x; LR44	12/48

EN LED flashlight
 PL Latarka LED
 DE LED Taschenlampe
 RU Светодиодный фонарь
 CS LED svítilna
 RO Lanterna cu LED
 HU LED zseblámpa
 ES Linterna LED



No.	Power / Moc [W]	Battery type / Rodzaj baterii	Box
88560	10	3x1.5V; AA	12/24

EN LED headlamp
 PL Latarka czołowa LED
 DE LED Kopflampe
 RU Налобный светодиодный фонарь
 CS Čelová lampa LED
 RO Lanterna cu LED pt. cap
 HU LED fejlámpa
 ES Lámpara LED de cabeza

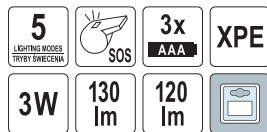

COB



No.	Battery type / Rodzaj baterii	Box
88678	3x1.5V; AAA	6/24

EN UV LED flashlight and glasses set
 PL Zestaw latarka UV LED i okulary
 DE UV LED Taschenlampe mit UV Schutzbrille
 RU Комплект для проверки утечек хладагента - УФ фонарь с очками
 CS UV LED svítilna + brýle
 RO Set lanterna UV LED si ochelari
 HU UV LED zseblámpa + szemüveg
 ES UV LED linterna con gafas para

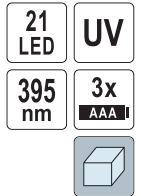

No.	Light source / Źródło światła [LED]	Battery type / Rodzaj baterii	Box
82756	21	3x1.5V; AAA	80

EN LED flashlight
 PL Latarka LED
 DE LED Taschenlampe
 RU Светодиодный фонарь
 CS LED svítilna
 RO Lanterna cu LED
 HU LED zseblámpa
 ES Linterna LED



No.	Power / Moc [W]	Battery type / Rodzaj baterii	Box
88555	5	3x1.5V; AAA	12/48

EN LED headlamp
 PL Latarka czołowa LED
 DE LED Kopflampe
 RU Налобный светодиодный фонарь
 CS Čelová lampa LED
 RO Lanterna cu LED pt. cap
 HU LED fejlámpa
 ES Lámpara LED de cabeza



SMD



No.	Battery type / Rodzaj baterii	Box
88677	3x1.5V; AAA	12/48

EN LED headlamp
 PL Latarka czołowa LED
 DE LED Kopflampe
 RU Налобный светодиодный фонарь
 CS Čelová lampa LED
 RO Lanterna cu LED pt. cap
 HU LED fejlámpa
 ES Lámpara LED de cabeza

8 LED
 3x AAA



LED



No.	Battery type / Rodzaj baterii	
88670	3x1.5V; AAA	12/72

EN LED headlamp
 PL Latarka czołowa LED
 DE LED Kopflampe
 RU Налобный светодиодный фонарь
 CS Čelová lampa LED
 RO Lanterna cu LED pt. cap
 HU LED fejlámpa
 ES Lámpara LED de cabeza

1 LED 1W 3 LIGHTING MODES TRYBY SWIECZENIA 3x AAA



POWER LED



No.	Battery type / Rodzaj baterii	
88673	3x1.5V; AAA	12/48

EN LED headlamp
 PL Latarka czołowa LED
 DE LED Kopflampe
 RU Налобный светодиодный фонарь
 CS Čelová lampa LED
 RO Lanterna cu LED pt. cap
 HU LED fejlámpa
 ES Lámpara LED de cabeza

1+2 LED 100 lm 3x AAA



POWER LED



No.	Battery type / Rodzaj baterii	
88675	3x1.5V; AAA	12/48

EN Winter hat with LED lamp
 PL Czapka zimowa z lampką LED
 DE Wintermütze mit LED-Lampe
 RU Зимняя шапка со светодиодным фонариком
 CS Zimní čepice s LED svítilnou
 RO Caciula iarna cu LED
 HU LED lámpás téli sapka
 ES Gorro de invierno con LED



No.	Color / Kolor	
74225	szary	10/80
74226	czarny	10/80
74227	granatowy	10/80

EN LED headlamp
 PL Latarka czołowa LED
 DE LED Kopflampe
 RU Налобный светодиодный фонарь
 CS Čelová lampa LED
 RO Lanterna cu LED pt. cap
 HU LED fejlámpa
 ES Lámpara LED de cabeza

1 LED 1W 3 LIGHTING MODES TRYBY SWIECZENIA 3x AAA



POWER LED



No.	Battery type / Rodzaj baterii	
88672	3x1.5V; AAA	12/60

EN LED headlamp
 PL Latarka czołowa LED
 DE LED Kopflampe
 RU Налобный светодиодный фонарь
 CS Čelová lampa LED
 RO Lanterna cu LED pt. cap
 HU LED fejlámpa
 ES Lámpara LED de cabeza

1 LED 1W 3 LIGHTING MODES TRYBY SWIECZENIA 3x AAA



POWER LED



No.	Battery type / Rodzaj baterii	
88674	3x1.5V; AAA	12/48

EN LED headlamp
 PL Latarka czołowa LED
 DE LED Kopflampe
 RU Налобный светодиодный фонарь
 CS Čelová lampa LED
 RO Lanterna cu LED pt. cap
 HU LED fejlámpa
 ES Lámpara LED de cabeza

3W 150 lm 3x AAA



COB LED



No.	Battery type / Rodzaj baterii	
88676	3x1.5V; AAA	12/48

UNIVERSAL SIZE ROZMIAR UNIVERSALNY 120 lm 3 LIGHTING MODES TRYBY SWIECZENIA 3.7 V 200mAh Li-Ion 1.5h 1.5-4h CHARGING LADOWANIE USB



EN LED bike light set
 PL Zestaw lamp rowerowych LED
 DE Fahrrad-Beleuchtungsset LED
 RU Набор светодиодных велосипедных фонарей
 CS Set LED osvětlení na kolo
 RO Set lanterna bicicleta LED
 HU LED kerékpár lámpa szett
 ES Juego de luces LED para bicicleta

5 LED, 2x AAA, 3W, 150 lm, 3x AAA, ZOOM



No.	Battery type / Rodzaj baterii	
88422	3x1.5V; AAA, 2x1.5V; AAA	12/48

EN Night lamp with body and light sensor
 PL Lampka nocna z czujnikiem ruchu i zmierniczu
 DE Nachtleuchte mit Bewegungsmelder und Helligkeitssensor
 RU Ночник с датчиком движения и сумеречного света
 CS Noční lampa se senzorem pohybu a soumraku
 RO Lampa de veghe cu senzor lumina
 HU Mozgás- és szűrületérzékelős éjjeli lámpa
 ES Luz de noche con sensor de movimiento y crepuscular

3W, 120 lm, 120°, 3m, 3x AAA



No.	Power / Moc [W]	Luminous flux / Strumień świetlny [lm]	
82830	3	120	25/100

EN Night lamp with body and light sensor
 PL Lampka nocna z czujnikiem ruchu i zmierniczu
 DE Nachtleuchte mit Bewegungsmelder und Helligkeitssensor
 RU Ночник с датчиком движения и сумеречного света
 CS Noční lampa se senzorem pohybu a soumraku
 RO Lampa de veghe cu senzor lumina
 HU Mozgás- és szűrületérzékelős éjjeli lámpa
 ES Luz de noche con sensor de movimiento y crepuscular

1W, 50 lm, 120°, 3m, 3.7V 600mAh Li-Po, 2h, 3h, USB BATTERY CHARGER LADÓVÁRKA



No.	Power / Moc [W]	Luminous flux / Strumień świetlny [lm]	Battery capacity / Pojemność akumulatora [mAh]	
82832	1	50	600	25/100

EN LED bike light set
 PL Zestaw lamp rowerowych LED
 DE Fahrrad-Beleuchtungsset LED
 RU Набор светодиодных велосипедных фонарей

CS Set LED osvětlení na kolo
 RO Set lanterna bicicleta LED
 HU LED kerékpár lámpa szett
 ES Juego de luces LED para bicicleta

1W, 3x AAA, 5 LED, 2x AAA



No.	Battery type / Rodzaj baterii	
88421	3x1.5V; AAA, 2x1.5V; AAA	12/120

EN Night lamp with body and light sensor
 PL Lampka nocna z czujnikiem ruchu i zmierniczu
 DE Nachtleuchte mit Bewegungsmelder und Helligkeitssensor
 RU Ночник с датчиком движения и сумеречного света
 CS Noční lampa se senzorem pohybu a soumraku
 RO Lampa de veghe cu senzor lumina
 HU Mozgás- és szűrületérzékelős éjjeli lámpa
 ES Luz de noche con sensor de movimiento y crepuscular

1W, 50 lm, 120°, 3m, 3x AAA



No.	Power / Moc [W]	Luminous flux / Strumień świetlny [lm]	
82831	1	50	25/100

EN Motion detector
 PL Czujnik ruchu
 DE Bewegungsfühler
 RU Детектор движения
 CS Snímač pohybu
 RO Senzor de mișcare
 HU Mozgásérzékelő
 ES Sensor del movimiento

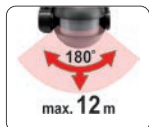
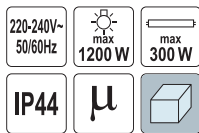

No.	
83120	50

EN Motion detector
 PL Czujnik ruchu
 DE Bewegungsfühler
 RU Детектор движения
 CS Snímač pohybu
 RO Senzor de mișcare
 HU Mozgásérzékelő
 ES Sensor del movimiento

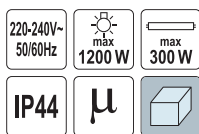

No.	
83122	50

EN Motion detector
 PL Czujnik ruchu
 DE Bewegungsfühler
 RU Детектор движения
 CS Snímač pohybu
 RO Senzor de mișcare
 HU Mozgásérzékelő
 ES Sensor del movimiento

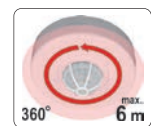

No.	
83124	50

EN Motion detector
 PL Czujnik ruchu
 DE Bewegungsfühler
 RU Детектор движения
 CS Snímač pohybu
 RO Senzor de mișcare
 HU Mozgásérzékelő
 ES Sensor del movimiento

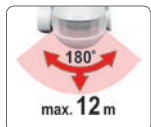
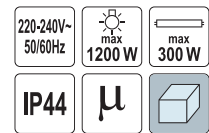

No.	
83121	50

EN Motion detector
 PL Czujnik ruchu
 DE Bewegungsfühler
 RU Детектор движения
 CS Snímač pohybu
 RO Senzor de mișcare
 HU Mozgásérzékelő
 ES Sensor del movimiento

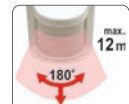
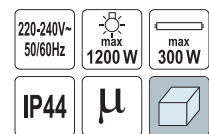

No.	
83123	50

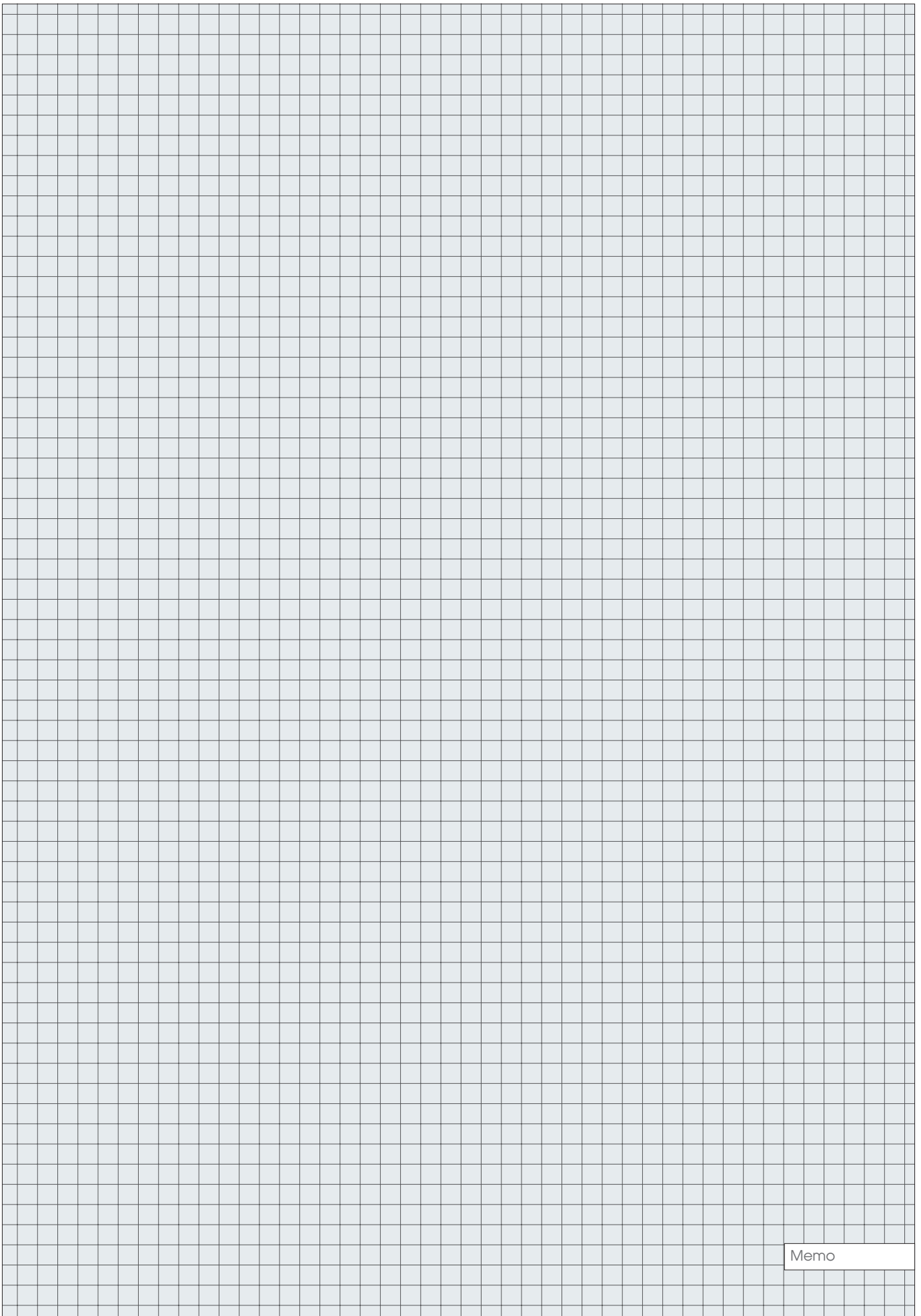

Memo

24

Garden tools & power tools
Narzędzia i elektronarzędzia ogrodowe



Watering program Program wodny

408-424



Hose connectors, male connectors, couplings, hose menders
Złącza, nypły, łączniki, rozgałęziacze, reparatory..... 408

Hose nozzles (sprinklers) & sets
Zraszacze i zestawy..... 412

Garden hoses
Wężę ogrodowe..... 418

Garden hose carts, holders & guides
Wózki, stojaki i prowadnice do węży..... 419

Pumps
Pompy..... 420

Irrigation valve boxes
Skrzynki zaworowe..... 422

PE pipes adapters
Złączki do rur PE..... 423

Water filters
Filtry do wody..... 424

Pruners & shears Sekatory i nożyce ogrodowe

424-430



Pruners
Sekatory..... 424

Lopping shears
Sekatory do gałęzi..... 427

Leverage tree pruners
Sekatory gąsienicowe..... 429

Hedge shears
Nożyce do żywopłotu..... 429

Grass shears
Nożyce do trawy..... 430

Garden saws & blades Piły ogrodowe i brzeszczoty

430-431



Axes & splitting wedges Siekiry i kliny do drewna

431-433



Hand tools Narzędzia ręczne

433-449



Small garden tools
Małe narzędzia ogrodowe..... 433

Big garden tools
Duże narzędzia ogrodowe..... 436

Handles
Trzonki..... 447

Sprayers & accessories Opryskiwacze i akcesoria

450-452



Gasoline garden tools, power tools & accessories Ogrodowe narzędzia spalinowe, elektronarzędzia i akcesoria

452-456



Grass trimmers
Wykasarki..... 452

Hedge trimmers
Nożyce do trawy i żywopłotu..... 452

Chainsaws
Pilarki łańcuchowe..... 453

Soil millers
Gleboğrafzarki..... 453

Accessories
Akcesoria..... 453

Health & safety products Artykuły BHP

456-461



Gloves
Rękawice..... 456

Rain boots
Kalosze..... 457

Multipurpose trays
Podstawki gospodarcze..... 458

Knee pads
Nakolanniki..... 459

Head, hearing & eyesight protection
Ochrona głowy, słuchu i wzroku..... 460

Garden accessories Akcesoria ogrodowe

462-471



BBQ grills & accessories Grille i akcesoria

471-481



Gas BBQ grills
Grille gazowe..... 471

Charcoal BBQ grills
Grille węglowe..... 473

Smokers
Wędzarnie..... 478

Fire pits
Paleniska ogrodowe..... 479

Accessories
Akcesoria..... 480

EN Hose connector
 PL Złącze
 DE Universal Schnellschlauchkupplung
 RU Соединитель
 CS Rychlospojka
 RO Mufă pt. pistol
 HU Fitting
 ES Junta estandar



1/2" 3/4"
 12.7mm 19mm
 ABS



No.	Hose diameter / Średnica węży	
89221	1/2" (12.5 mm)	150/600
89223	3/4" (19.0 mm)	60/240

EN Hose connector
 PL Złącze
 DE Universal Schnellschlauchkupplung
 RU Соединитель
 CS Rychlospojka
 RO Mufă pt. pistol
 HU Fitting
 ES Junta estandar



1/2" 3/4"
 12.7mm 19mm
 ABS



No.	Hose diameter / Średnica węży	
89001	1/2" (12.5 mm)	30/240
89002	3/4" (19.0 mm)	30/240

EN Hose connector
 PL Złącze
 DE Universal Schnellschlauchkupplung
 RU Соединитель
 CS Rychlospojka
 RO Mufă pt. pistol
 HU Fitting
 ES Junta estandar



1/2" 3/4"
 12.7mm 19mm
 ABS STOP



No.	Hose diameter / Średnica węży	
89226	1/2" (12.5 mm)	24/288
89228	3/4" (19.0 mm)	24/288

EN Brass hose connector
 PL Złącze mosiężne
 DE Schlauch-Schnellkupplung
 RU Быстростъёмная муфта
 CS Rychlospojka
 RO Manşon de îmbinare
 HU Csatlakozó
 ES Conexión



1/2" 3/4"
 12.7mm 19mm
 BRASS MOSIADZ



No.	Hose diameter / Średnica węży	
89100	1/2" (12.5 mm)	48
89102	3/4" (19.0 mm)	48

EN Hose connector
 PL Złącze
 DE Universal Schnellschlauchkupplung
 RU Соединитель
 CS Rychlospojka
 RO Mufă pt. pistol
 HU Fitting
 ES Junta estandar



1/2" 3/4"
 12.7mm 19mm
 ABS



No.	Hose diameter / Średnica węży	
89222	1/2" (12.5 mm)	24/288
89224	3/4" (19.0 mm)	24/288

EN Hose connector
 PL Złącze
 DE Universal Schnellschlauchkupplung
 RU Соединитель
 CS Rychlospojka
 RO Mufă pt. pistol
 HU Fitting
 ES Junta estandar



1/2" 3/4"
 12.7mm 19mm
 ABS STOP



No.	Hose diameter / Średnica węży	
89225	1/2" (12.5 mm)	150/600
89227	3/4" (19.0 mm)	60/240

EN Hose connector
 PL Złącze
 DE Universal Schnellschlauchkupplung
 RU Соединитель
 CS Rychlospojka
 RO Mufă pt. pistol
 HU Fitting
 ES Junta estandar



1/2" 3/4"
 12.7mm 19mm
 ABS STOP



No.	Hose diameter / Średnica węży	
89003	1/2" (12.5 mm)	30/240
89004	3/4" (19.0 mm)	30/240

EN Brass hose connector
 PL Złącze mosiężne
 DE Schlauch-Schnellkupplung
 RU Быстростъёмная муфта
 CS Rychlospojka
 RO Manşon de îmbinare
 HU Csatlakozó
 ES Conexión



1/2" 3/4"
 12.7mm 19mm
 BRASS MOSIADZ STOP



No.	Hose diameter / Średnica węży	
89101	1/2" (12.5 mm)	48
89103	3/4" (19.0 mm)	48

EN Hose mender
 PL Reparatör do węża
 DE Schlauchreparator
 RU Соединитель шлангов
 CS Opravka
 RO Mufă înădire
 HU Györstöldő
 ES Reparatör para manguera

1/2" 3/4" ABS
 12.7mm 19mm



FLO

No.	Hose diameter / Šrednica węża	
89229	1/2" (12.5 mm)	150/600
89231	3/4" (19.0 mm)	60/240

EN Hose mender
 PL Reparatör do węża
 DE Schlauchreparator
 RU Соединитель шлангов
 CS Opravka
 RO Mufă înădire
 HU Györstöldő
 ES Reparatör para manguera

1/2" 3/4" ABS
 12.7mm 19mm



FLO

No.	Hose diameter / Šrednica węża	
89007	1/2" (12.5 mm)	30/240
89008	3/4" (19.0 mm)	30/240

EN Hose reducer
 PL Reduktor do węża
 DE Schlauch Druckminderer
 RU Редуктор
 CS Redukce
 RO Reductor
 HU Szűkítő
 ES Reductor para manguera

1/2" 3/4" ABS
 12.7mm 19mm



FLO

No.	Hose diameter / Šrednica węża	
89233	1/2" (12.5 mm), 3/4" (19.0 mm)	60/240

EN Hose reducer
 PL Reduktor do węża
 DE Schlauch Druckminderer
 RU Редуктор
 CS Redukce
 RO Reductor
 HU Szűkítő
 ES Reductor para manguera

1/2" 3/4" ABS
 12.7mm 19mm



FLO

No.	Hose diameter / Šrednica węża	
89011	1/2" (12.5 mm), 3/4" (19.0 mm)	30/240

EN Hose mender
 PL Reparatör do węża
 DE Schlauchreparator
 RU Соединитель шлангов
 CS Opravka
 RO Mufă înădire
 HU Györstöldő
 ES Reparatör para manguera

1/2" 3/4" ABS
 12.7mm 19mm



FLO

No.	Hose diameter / Šrednica węża	
89230	1/2" (12.5 mm)	24/288
89232	3/4" (19.0 mm)	24/288

EN Hose mender
 PL Reparatör do węża
 DE Schlauchreparator
 RU Соединитель шлангов
 CS Opravka
 RO Mufă înădire
 HU Györstöldő
 ES Reparatör para manguera

1/2" 3/4" BRASS
 12.7mm 19mm



FLO

No.	Hose diameter / Šrednica węża	
89104	1/2" (12.5 mm)	48
89105	3/4" (19.0 mm)	48

EN Hose reducer
 PL Reduktor do węża
 DE Durchflussminderer für Schläuche
 RU Редуктор для шланга
 CS Redukce hadice
 RO Mufa inadire
 HU Tömölő reduktor
 ES Reductor para manguera

1/2" 3/4" ABS
 12.7mm 19mm



FLO

No.	Hose diameter / Šrednica węża	
89234	1/2" (12.5 mm), 3/4" (19.0 mm)	24/288

EN Snap-in tap adaptor
 PL Przyłącze do kranu
 DE Wasserhahnanschluss für Gartenschlauch
 RU Адаптер внешний
 CS Šroubení
 RO Mufă pt. robinet cu filet interior
 HU Tömölvég csaphoz
 ES Tubuladura de grifo

1/2" ABS
 12.7mm



FLO

No.	Hose diameter / Šrednica węża	
89253	1/2" (12.5 mm)	24/240

EN Male connector
 PL Nypel
 DE Anschlussgerätestück
 RU Адаптер внутренний
 CS Spojka
 RO Mufă pt. robinet cu filet exterior
 HU Kúlso menetestölvég
 ES Nypel

3/4"
19mm ABS



No.	Connector thread size / Rozmiar gwintu przyłącza	
89239	G3/4	250/1000

EN Snap-in tap adaptor
 PL Przyłącze do kranu
 DE Wasserhahnanschluss für Gartenschlauch
 RU Адаптер внешний
 CS Šroubení
 RO Mufă pt. robinet cu filet interior
 HU Tömlovég csaphoz
 ES Tubuladura de grifo

3/4"
19mm ABS



No.	Connector thread size / Rozmiar gwintu przyłącza	
89015	G3/4	30/240

EN Snap-in tap adaptor
 PL Przyłącze do kranu
 DE Wasserhahnanschluss für Gartenschlauch
 RU Адаптер для крана
 CS Šroubení
 RO Mufă pt. robinet cu filet interior
 HU Tömlovég csaphoz
 ES Tubuladura de grifo

3/4"
19mm ABS



No.	Connector thread size / Rozmiar gwintu przyłącza	
89235	G3/4	250/1000

EN Snap-in tap adaptor
 PL Przyłącze do kranu
 DE Wasserhahnanschluss für Gartenschlauch
 RU Адаптер для крана
 CS Šroubení
 RO Mufă pt. robinet cu filet interior
 HU Tömlovég csaphoz
 ES Tubuladura de grifo

3/4"
19mm ABS



No.	Connector thread size / Rozmiar gwintu przyłącza	
89013	G3/4	30/240

EN Male connector
 PL Nypel
 DE Anschlussgerätestück
 RU Адаптер внутренний
 CS Spojka
 RO Mufă pt. robinet cu filet exterior
 HU Kúlso menetestölvég
 ES Nypel

3/4"
19mm ABS



No.	Connector thread size / Rozmiar gwintu przyłącza	
89240	G3/4	24/288

EN Male connector
 PL Nypel
 DE Anschlussgerätestück
 RU Адаптер внутренний
 CS Spojka
 RO Mufă pt. robinet cu filet exterior
 HU Kúlso menetestölvég
 ES Nypel

3/4"
19mm BRASS MOSIADZ



No.	Connector thread size / Rozmiar gwintu przyłącza	
89110	G3/4	48

EN Snap-in tap adaptor
 PL Przyłącze do kranu
 DE Wasserhahnanschluss für Gartenschlauch
 RU Адаптер для крана
 CS Šroubení
 RO Mufă pt. robinet cu filet interior
 HU Tömlovég csaphoz
 ES Tubuladura de grifo

3/4"
19mm ABS



No.	Connector thread size / Rozmiar gwintu przyłącza	
89236	G3/4	24/288

EN Snap-in tap adaptor
 PL Przyłącze do kranu
 DE Wasserhahnanschluss für Gartenschlauch
 RU Адаптер для крана
 CS Šroubení
 RO Mufă pt. robinet cu filet interior
 HU Tömlovég csaphoz
 ES Tubuladura de grifo

3/4"
19mm 1" 25mm BRASS MOSIADZ



No.	Connector thread size / Rozmiar gwintu przyłącza	
89106	G3/4	48
89107	G1	48

EN Snap-in tap adaptor
 PL Przyłącze do kranu
 DE Wasserhahnanschluss für Gartenschlauch
 RU Адаптер для крана
 CS Šroubení
 RO Mufă pt. robinet cu filet interior
 HU Tömlovég csaphoz
 ES Tubuladura de grifo



1/2" 3/4"
 12.7mm 19mm
 1" ABS
 25mm



No.	Connector thread size / Rozmiar gwintu przyłącza	
89241	G1/2, G3/4	250/1000
89251	G3/4, G1	100/1000

EN Snap-in tap adaptor
 PL Przyłącze do kranu
 DE Wasserhahnanschluss für Gartenschlauch
 RU Адаптер для крана
 CS Šroubení
 RO Mufă pt. robinet cu filet interior
 HU Tömlovég csaphoz
 ES Tubuladura de grifo



1/2" 3/4"
 12.7mm 19mm
 1" ABS
 25mm



No.	Connector thread size / Rozmiar gwintu przyłącza	
89017	G1/2, G3/4	30/240
89018	G3/4, G1	30/240

EN 2 way coupling
 PL Złącze typu „I”
 DE Doppelkupplung
 RU Соединитель шлангов
 CS Spojka
 RO Prelungitor furtun apă
 HU „I” típusú csőtoldaló idom
 ES Junta tipo „I”



1/2" ABS
 12.7mm



No.	Water outlet diameter / Średnica przyłącza wody	
89245	1/2" (12.5 mm)	125/500

EN 2 way coupling
 PL Złącze typu „I”
 DE Doppelkupplung
 RU Соединитель шлангов
 CS Spojka
 RO Prelungitor furtun apă
 HU „I” típusú csőtoldaló idom
 ES Junta tipo „I”



ABS



No.	Water outlet diameter / Średnica przyłącza wody	
89020	1/2" (12.5 mm)	30/240

EN Snap-in tap adaptor
 PL Przyłącze do kranu
 DE Wasserhahnanschluss für Gartenschlauch
 RU Адаптер для крана
 CS Šroubení
 RO Mufă pt. robinet cu filet interior
 HU Tömlovég csaphoz
 ES Tubuladura de grifo



1/2" 3/4"
 12.7mm 19mm
 1" ABS
 25mm



No.	Connector thread size / Rozmiar gwintu przyłącza	
89242	G1/2, G3/4	24/288
89252	G3/4, G1	24/288

EN Snap-in tap adaptor
 PL Przyłącze do kranu
 DE Wasserhahnanschluss für Gartenschlauch
 RU Адаптер для крана
 CS Šroubení
 RO Mufă pt. robinet cu filet interior
 HU Tömlovég csaphoz
 ES Tubuladura de grifo



1/2" 3/4"
 12.7mm 19mm
 1" BRASS
 25mm MOSIADZ



No.	Connector thread size / Rozmiar gwintu przyłącza	
89108	G1/2, G3/4	48
89109	G3/4, G1	48

EN 2 way coupling
 PL Złącze typu „I”
 DE Doppelkupplung
 RU Соединитель шлангов
 CS Spojka
 RO Prelungitor furtun apă
 HU „I” típusú csőtoldaló idom
 ES Junta tipo „I”



1/2" ABS
 12.7mm



No.	Water outlet diameter / Średnica przyłącza wody	
89246	1/2" (12.5 mm)	24/288

EN 2 way coupling
 PL Złącze typu „I”
 DE Doppelkupplung
 RU Соединитель шлангов
 CS Spojka
 RO Prelungitor furtun apă
 HU „I” típusú csőtoldaló idom
 ES Junta tipo „I”



1/2" BRASS
 12.7mm MOSIADZ



No.	Water outlet diameter / Średnica przyłącza wody	
89113	1/2" (12.5 mm)	48

EN 3 way coupling
 PL Rozdzielacz typu „Y”
 DE Drei Wege Kupplung
 RU Тройник для шлангов
 CS Y-kus
 RO Distributor 3 cai
 HU „Y” típusú elágazás
 ES Distribuidor tipo „Y”



No.		
89243		125/250

EN 3 way coupling
 PL Rozdzielacz typu „Y”
 DE Drei Wege Kupplung
 RU Тройник для шлангов
 CS Y-kus
 RO Distributor 3 cai
 HU „Y” típusú elágazás
 ES Distribuidor tipo „Y”



No.	Water outlet diameter / Średnica przyłącza wody	
89112	1/2" (12.5 mm)	48

EN Y-switch coupling with swivel
 PL Rozdzielacz z zaworami
 DE 2-Wege Ventil
 RU Распределитель внешний
 CS Rozbočovač s uzavíracími ventily
 RO Racord iny cu robinet
 HU Y-elágazó, 2 db külső menetes elzáróval
 ES Distribuidor tipo „Y”



No.	Connector thread size / Rozmiar gwintu przyłącza	
89248	G3/4	12/96

EN Adjustable spray nozzle
 PL Zraszacz prosty regulowany
 DE Spritze
 RU Распылитель поливочный
 CS Postřikovač
 RO Stropitor apă
 HU Szórófej
 ES Rociador



No.		
89201		25/100

EN 3 way coupling
 PL Rozdzielacz typu „Y”
 DE Drei Wege Kupplung
 RU Тройник для шлангов
 CS Y-kus
 RO Distributor 3 cai
 HU „Y” típusú elágazás
 ES Distribuidor tipo „Y”



No.		
89244		24/288

EN Y-switch coupling with swivel
 PL Rozdzielacz z zaworami
 DE 2-Wege Ventil
 RU Распределитель внешний
 CS Rozbočovač s uzavíracími ventily
 RO Racord iny cu robinet
 HU Y-elágazó, 2 db külső menetes elzáróval
 ES Distribuidor tipo „Y”



No.	Connector thread size / Rozmiar gwintu przyłącza	
89247	G3/4	24/240

EN Y-switch coupling with swivel
 PL Rozdzielacz z zaworami
 DE 2-Wege Ventil
 RU Распределитель внешний
 CS Rozbočovač s uzavíracími ventily
 RO Racord iny cu robinet
 HU Y-elágazó, 2 db külső menetes elzáróval
 ES Distribuidor tipo „Y”

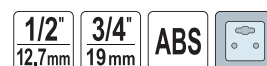

No.	Water outlet diameter / Średnica przyłącza wody	Connector thread size / Rozmiar gwintu przyłącza	
89022	1/2" (12.5 mm)	G3/4	12/120

EN Adjustable spray nozzle
 PL Zraszacz prosty regulowany
 DE Spritze
 RU Распылитель поливочный
 CS Postřikovač
 RO Stropitor apă
 HU Szórófej
 ES Rociador



No.		
89020		12/120

EN Adjustable spray nozzle
 PL Zraszacz prosty regulowany
 DE Spritze
 RU Распылитель поливочный
 CS Postřikovač
 RO Stropitor apă
 HU Szórőfej
 ES Rociador



No.	
89200	25/200

EN Straight nozzle
 PL Pistolet zraszający regulowany
 DE Regelbare Sprühpistole
 RU Регулируемый оросительный пистолет
 CS Kropící pistole regulovatelná
 RO Pistolet de irigare ajustabil
 HU Öntöző pisztoly állítható sugarú
 ES Pistola rociadora ajustable



No.	
89120	48

EN Adjustable spray gun
 PL Pistolet zraszający regulowany
 DE Regelbare Sprühpistole
 RU Регулируемый оросительный пистолет
 CS Kropící pistole regulovatelná
 RO Pistolet de irigare ajustabil
 HU Öntöző pisztoly állítható sugarú
 ES Pistola rociadora ajustable

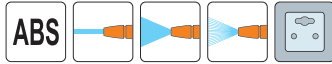

No.	
89213	12/48

EN Adjustable spray gun
 PL Pistolet zraszający regulowany
 DE Regelbare Sprühpistole
 RU Регулируемый оросительный пистолет
 CS Kropící pistole regulovatelná
 RO Pistolet de irigare ajustabil
 HU Öntöző pisztoly állítható sugarú
 ES Pistola rociadora ajustable

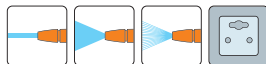

No.	
89189	12/48

EN Adjustable spray nozzle
 PL Zraszacz prosty regulowany
 DE Spritze
 RU Распылитель поливочный
 CS Postřikovač
 RO Stropitor apă
 HU Szórőfej
 ES Rociador



No.	
89187	48

EN Adjustable spray gun
 PL Pistolet zraszający regulowany
 DE Regelbare Sprühpistole
 RU Регулируемый оросительный пистолет
 CS Kropící pistole regulovatelná
 RO Pistolet de irigare ajustabil
 HU Öntöző pisztoly állítható sugarú
 ES Pistola rociadora ajustable



No.	
89210	12/48

EN Adjustable spray gun
 PL Pistolet zraszający regulowany
 DE Regelbare Sprühpistole
 RU Регулируемый оросительный пистолет
 CS Kropící pistole regulovatelná
 RO Pistolet de irigare ajustabil
 HU Öntöző pisztoly állítható sugarú
 ES Pistola rociadora ajustable



No.	
89214	12/48

EN Adjustable spray gun
 PL Pistolet zraszający regulowany
 DE Regelbare Sprühpistole
 RU Регулируемый оросительный пистолет
 CS Kropící pistole regulovatelná
 RO Pistolet de irigare ajustabil
 HU Öntöző pisztoly állítható sugarú
 ES Pistola rociadora ajustable

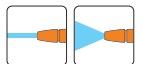

No.	
89193	12/48

- EN Adjustable spray gun
- PL Pistolet zraszający regulowany
- DE Regelbare Sprühpistole
- RU Регулируемый оросительный пистолет
- CS Kropící pistole regulovatelná
- RO Pistolet de irigare ajustabil
- HU Öntöző pisztoly állítható sugarú
- ES Pistola rociadora ajustable

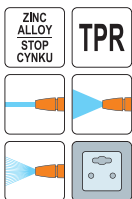

FLO

No.	
89190	12/48

- EN Sprinkling gun
- PL Pistolet zraszający
- DE Spritzpistole
- RU Оросительный пистолет
- CS Postřikovací pistole
- RO Pistol pt. pulverizare
- HU Öntöző pisztoly
- ES Pistola para regar

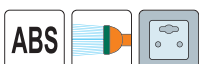

FLO

No.	
89209	12/48

- EN Multifunction sprinkling gun
- PL Wielofunkcyjny pistolet zraszający
- DE Multifunktions-Spritzpistole
- RU Многофункциональный оросительный пистолет
- CS Multifunkční postřikovací pistole
- RO Pistol multifuncțional pt. pulverizare
- HU Többfunkciós öntöző pisztoly
- ES Pistola para regar multifuncional

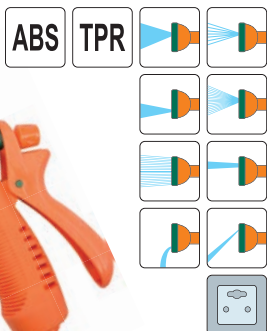

FLO

No.	
89211	12/48

- EN Multifunction sprinkling gun
- PL Wielofunkcyjny pistolet zraszający
- DE Multifunktions-Spritzpistole
- RU Многофункциональный оросительный пистолет
- CS Multifunkční postřikovací pistole
- RO Pistol multifuncțional pt. pulverizare
- HU Többfunkciós öntöző pisztoly
- ES Pistola para regar multifuncional

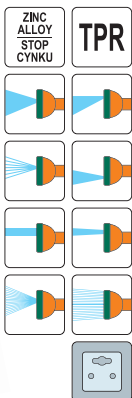

FLO

No.	
89195	6/24

- EN Adjustable spray gun
- PL Pistolet zraszający regulowany
- DE Regelbare Sprühpistole
- RU Регулируемый оросительный пистолет
- CS Kropící pistole regulovatelná
- RO Pistolet de irigare ajustabil
- HU Öntöző pisztoly állítható sugarú
- ES Pistola rociadora ajustable

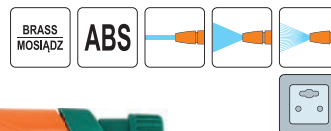

FLO

No.	
89215	12/24

- EN Multifunction sprinkling gun
- PL Wielofunkcyjny pistolet zraszający
- DE Multifunktions-Spritzpistole
- RU Многофункциональный оросительный пистолет
- CS Multifunkční postřikovací pistole
- RO Pistol multifuncțional pt. pulverizare
- HU Többfunkciós öntöző pisztoly
- ES Pistola para regar multifuncional

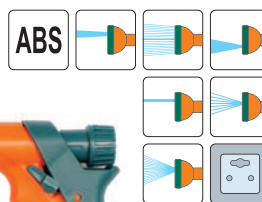

FLO

No.	
89220	12/48

- EN Multifunction sprinkling gun
- PL Wielofunkcyjny pistolet zraszający
- DE Multifunktions-Spritzpistole
- RU Многофункциональный оросительный пистолет
- CS Multifunkční postřikovací pistole
- RO Pistol multifuncțional pt. pulverizare
- HU Többfunkciós öntöző pisztoly
- ES Pistola para regar multifuncional

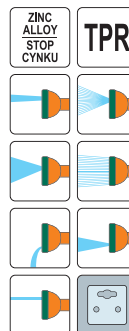

FLO

No.	
89192	12/48

- EN Multifunction sprinkling gun
- PL Wielofunkcyjny pistolet zraszający
- DE Multifunktions-Spritzpistole
- RU Многофункциональный оросительный пистолет
- CS Multifunkční postřikovací pistole
- RO Pistol multifuncțional pt. pulverizare
- HU Többfunkciós öntöző pisztoly
- ES Pistola para regar multifuncional

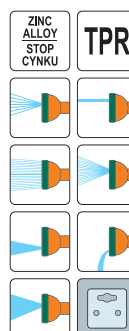

FLO

No.	
89191	12/48

EN Basic hose set with straight nozzle
 PL Zestaw złączek ze zraszczaczem prostym
 DE Bewässerungs Spritz und Anschlussset
 RU Набор поливочный
 CS Postřikovač + spojky
 RO Ștut furtun apă cu accesorii pt. robinet
 HU Készlet gyorskapocsal csaphoz
 ES Juego de rociar tubuladura de grifo



4 PCS 1/2" 12.7mm
 3/4" 19mm 1" 25mm
 ABS



No.	Hose diameter / Średnica węża	Connector thread size / Rozmiar gwintu przyłącza	pcs / szt.	
89203	1/2" (12.5 mm)	G3/4, G1	4	12/72
89204	1/2" (12.5 mm)	G1/2, G3/4	4	12/72

EN Basic hose set with adjustable spray gun
 PL Zestaw złączek ze zraszczaczem pistoletowym
 DE Spritzbrause und Anschlussset
 RU Набор поливочный
 CS Rozprašovací pistole na vodu + spojky
 RO Pistol reglabil cu și accesorii
 HU Résztes készlet – os tömlőhöz
 ES Juego de rociar para manguera



4 PCS ABS



No.	Hose diameter / Średnica węża	Connector thread size / Rozmiar gwintu przyłącza	pcs / szt.	
89207	3/4" (19.0 mm)	G3/4	4	12/48

EN Coil hose set with spray gun
 PL Wąż spiralny z pistoletem zraszczającym
 DE Spiralschlauch mit Multifunktionsbrause
 RU Спиральный шланг в наборе с пистолетом
 CS Pištof striekacia s vinutou hadicou
 RO Furtun în spirală cu pistol pt. stropitt
 HU Locsoló pisztoly tömlővel
 ES Manguera espiral con rociador



15m EVA



No.	Hose length / Długość węża [m]	
89351	15	8

EN Sprinkling lance
 PL Lanza zraszczająca wielofunkcyjna
 DE Multifunktions-Spritzstab
 RU Пика для распылителя многофункциональная
 CS Multifunkční postřikovací nadstavec
 RO Tijă pt. îngăre
 HU Többfunkciós esőztető fej
 ES Lanza para regar multifuncional

AI ABS



No.	
89218	12

EN Basic hose set with adjustable spray gun
 PL Zestaw złączek ze zraszczaczem pistoletowym
 DE Spritzbrause und Anschlussset
 RU Набор поливочный
 CS Rozprašovací pistole na vodu + spojky
 RO Pistol reglabil cu și accesorii
 HU Résztes készlet – os tömlőhöz
 ES Juego de rociar para manguera



4 PCS ABS



No.	Hose diameter / Średnica węża	Connector thread size / Rozmiar gwintu przyłącza	pcs / szt.	
89206	1/2" (12.5 mm)	G1/2	4	12/48

EN Basic hose set with adjustable spray gun
 PL Zestaw złączek ze zraszczaczem pistoletowym
 DE Spritzbrause und Anschlussset
 RU Набор поливочный
 CS Rozprašovací pistole na vodu + spojky
 RO Pistol reglabil cu și accesorii
 HU Résztes készlet – os tömlőhöz
 ES Juego de rociar para manguera



4 PCS ABS



No.	Hose diameter / Średnica węża	Connector thread size / Rozmiar gwintu przyłącza	pcs / szt.	
89208	1/2" (12.5 mm)	G1/2	4	12/48

EN Garden shower
 PL Prysznic ogrodowy
 DE Gartendusche
 RU Распылитель садовый
 CS Zahradní sprcha
 RO Duș pt. grădină
 HU Kerti zuhany
 ES Regadera para jardín



240 165 cm



No.	
89390	6

EN 3-arms revolving sprinkler
 PL Zraszacz 3-ramienny
 DE 3-Arm Kreis-Regner
 RU Трехсторонний распылитель
 CS Rozprašovač třiramenný
 RO Aspersol cu 3 brate
 HU Forgó locsoló leszűrhető
 ES Rociador 3-brazos



EN 3-arms revolving sprinkler
 PL Zraszacz 3-ramienny
 DE 3-Arm Kreis-Regner
 RU Трехсторонний распылитель
 CS Rozprašovač třiramenný
 RO Aspersol cu 3 brate
 HU Forgó locsoló leszűrhető
 ES Rociador 3-brazos



FLO

No. 89272 12/48

FLO

No. 89263 12/48

EN Impulse sprinkler
 PL Zraszacz impulsowy
 DE Impulssprenger
 RU Распылитель импульсный на пике
 CS Postřikovač
 RO Stropitor apă
 HU Impulzus szórófej
 ES Rociador

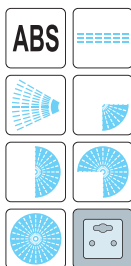

EN Impulse sprinkler
 PL Zraszacz impulsowy
 DE Impulssprenger
 RU Распылитель импульсный на пике
 CS Postřikovač
 RO Stropitor apă
 HU Impulzus szórófej
 ES Rociador

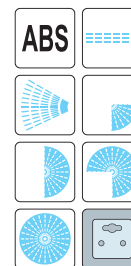

FLO

No. 89261 12/48

FLO

No. 89269 12/48

EN Impulse sprinkler
 PL Zraszacz impulsowy
 DE Impulssprenger
 RU Распылитель импульсный на пике
 CS Postřikovač
 RO Stropitor apă
 HU Impulzus szórófej
 ES Rociador

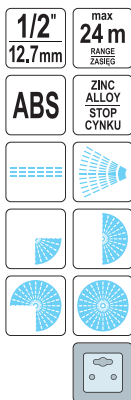

EN Impulse sprinkler
 PL Zraszacz impulsowy
 DE Impulssprenger
 RU Распылитель импульсный на пике
 CS Postřikovač
 RO Stropitor apă
 HU Impulzus szórófej
 ES Rociador

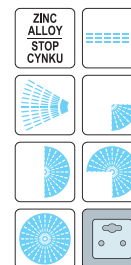

FLO

No. 89259 48

FLO

No. 89260 12/48

EN Sprinkler
 PL Zraszacz szpilkowy
 DE Sprenger
 RU Дождеватель
 CS Kolíkový zavlažovač
 RO Aspersol
 HU Esőtételő
 ES Aspersor



EN 8 pattern sprinkler
 PL Zraszacz 8-funkcyjny
 DE 8-Flächenregner
 RU Распылитель 8-позиционный на подставке
 CS Postřikovač
 RO Stropitor apă cu 8 duze
 HU 8 funkciós szórófej
 ES Rociador 8-funciones de tierra



FLO

No. 89265 24/48

FLO

No. 89257 20/120

EN Impulse sprinkler
 PL Zraszacz impulsowy
 DE Impulssprenger
 RU Распылитель импульсный на пике
 CS Postřikovač
 RO Stropitor apă
 HU Impulzus szórófej
 ES Rociador

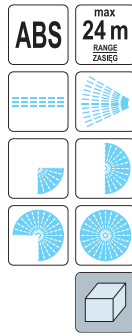

FLO

No.
89275

48

EN Oscillating sprinkler
 PL Zraszacz oscylacyjny
 DE Rechteckregner
 RU Распылитель осциллирующий
 CS Obdélníkový zavlažovač
 RO Aspensor oscilant
 HU Oszillációs szórófej
 ES Aspensor oscilante



FLO

No.
89277

12

EN Pop-up sprinkler
 PL Zraszacz wynurzalny
 DE Auftauch-Sprinkler
 RU Выдвижной спринклер
 CS Výsuvný zavlažovač
 RO Aspensor pop-up
 HU Süllyesztett öntözőfej
 ES Aspensor emergente



FLO

No.
89162

100

EN Pop-up sprinkler
 PL Zraszacz wynurzalny
 DE Auftauch-Sprinkler
 RU Выдвижной спринклер
 CS Výsuvný zavlažovač
 RO Aspensor pop-up
 HU Süllyesztett öntözőfej
 ES Aspensor emergente

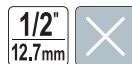

FLO

No.
89164

50

EN Impulse sprinkler
 PL Zraszacz impulsowy
 DE Impulssprenger
 RU Распылитель импульсный на пике
 CS Postřikovač
 RO Stropitor apă
 HU Impulzus szórófej
 ES Rociador

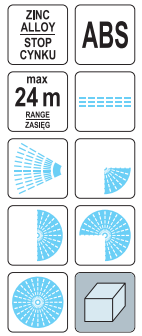

FLO

No.
89271

48

EN Impulse pop-up sprinkler
 PL Zraszacz wynurzalny
 DE Tauchimpulssprinkler
 RU Дождеватель выдвижной
 CS Zavlažovač výsuvný
 RO Aspensor cu impuls
 HU Esőztető szórófej
 ES Rociador de emerjer



FLO

No.
89280

12

EN Pop-up sprinkler
 PL Zraszacz wynurzalny
 DE Auftauch-Sprinkler
 RU Выдвижной спринклер
 CS Výsuvný zavlažovač
 RO Aspensor pop-up
 HU Süllyesztett öntözőfej
 ES Aspensor emergente

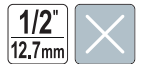

FLO

No.
89163

100

EN Nozzle for pop-up sprinkler
 PL Głowica zraszacza
 DE Sprinklerkopf
 RU Спринклерная головка
 CS Zavlažovací hlavice
 RO Duza pt. aspensor pop-up
 HU Öntözőfej
 ES Cabeza de aspensor



FLO

No.
89165

30/1200

EN Nozzle for pop-up sprinkler
 PL Głowica zraszacza
 DE Sprinklerkopf
 RU Спринклерная головка
 CS Zavlažovací hlavice
 RO Duza pt. aspersor pop-up
 HU Öntözőfej
 ES Cabeza de aspersor



EN Nozzle for pop-up sprinkler
 PL Głowica zraszacza
 DE Sprinklerkopf
 RU Спринклерная головка
 CS Zavlažovací hlavice
 RO Duza pt. aspersor pop-up
 HU Öntözőfej
 ES Cabeza de aspersor



No.	30/1200
89166	



No.	30/1200
89167	

EN Garden hose
 PL Wąż ogrodowy
 DE Gartenschlauch
 RU Садовый шланг

CS Zahradní hadice
 RO Furtun de gradina
 HU Kerti tömlő
 ES Manguera de jardín

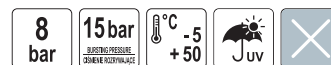

No.	L [m]	Diameter / Šrednica	1
89302	20	1/2" (12.5 mm)	1
89303	30	1/2" (12.5 mm)	1
89305	50	1/2" (12.5 mm)	1
89307	20	3/4" (19.0 mm)	1
89308	30	3/4" (19.0 mm)	1
89310	50	3/4" (19.0 mm)	1
89298	20	1" (25.0 mm)	1
89299	30	1" (25.0 mm)	1
89300	50	1" (25.0 mm)	1



EN Garden hose
 PL Wąż ogrodowy
 DE Gartenschlauch
 RU Садовый шланг

CS Zahradní hadice
 RO Furtun de gradina
 HU Kerti tömlő
 ES Manguera de jardín

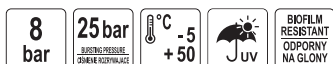

EN Garden hose
 PL Wąż ogrodowy
 DE Gartenschlauch
 RU Садовый шланг

CS Zahradní hadice
 RO Furtun de gradina
 HU Kerti tömlő
 ES Manguera de jardín

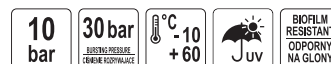

No.	L [m]	Diameter / Šrednica	1
89311	20	1/2" (12.5 mm)	1
89312	30	1/2" (12.5 mm)	1
89313	50	1/2" (12.5 mm)	1
89314	20	3/4" (19.0 mm)	1
89315	30	3/4" (19.0 mm)	1
89316	50	3/4" (19.0 mm)	1
89318	20	1" (25.0 mm)	1
89319	30	1" (25.0 mm)	1
89320	50	1" (25.0 mm)	1



No.	L [m]	Diameter / Šrednica	1
89290	20	1/2" (12.5 mm)	1
89291	30	1/2" (12.5 mm)	1
89292	50	1/2" (12.5 mm)	1
89293	20	3/4" (19.0 mm)	1
89294	30	3/4" (19.0 mm)	1
89295	50	3/4" (19.0 mm)	1

EN Garden hose
 PL Wąż ogrodowy
 DE Gartenschlauch
 RU Садовый шланг
 CS Zahradní hadice
 RO Furtun de gradina
 HU Kerti tömlő
 ES Manguera de jardín



FLO

No.	L [m]	Diameter / Šrednica	
89380	15	1/2" (12.5 mm)	1
89381	25	1/2" (12.5 mm)	1
89382	35	1/2" (12.5 mm)	1
89383	45	1/2" (12.5 mm)	1
89384	15	3/4" (19.0 mm)	1
89385	25	3/4" (19.0 mm)	1
89386	35	3/4" (19.0 mm)	1
89387	45	3/4" (19.0 mm)	1

EN Drip hose
 PL Wąż kropiujący
 DE Tropfschlauch
 RU Капельный шланг
 CS Kapačí hadice
 RO Picurare furtun
 HU Locsolótömlő
 ES Manguera de goteo

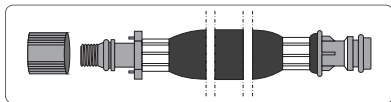
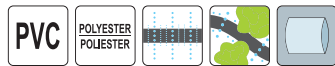

FLO

No.	L [m]	
89370	7.5	32
89371	15.0	15
89372	22.5	12
89373	30.0	8

EN Hose holder
 PL Stojak do węża ogrodowego
 DE Gartenschlauchträger
 RU Барабан для намотки поливочного шланга
 CS Stojan navijeci na zahradní hadici
 RO Suport pt. furtun
 HU Utartódob locsolótömlőhöz
 ES Estante para manguera de jardín

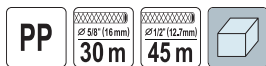

FLO

No.	
89330	5

EN Soaker hose
 PL Wąż zraszający
 DE Einweichen Schlauch
 RU Спринклерный шланг
 CS Hádiový zavlažovač
 RO Furtun de aspersoare
 HU Esőztetőtömlő
 ES Manguera de remojo

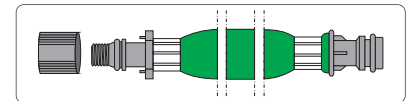
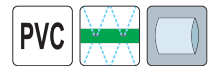

FLO

No.	L [m]	
89360	7.5	32
89361	15.0	15

EN Pump drain hose
 PL Wąż odpływowy do pomp
 DE Abflussschlauch für die Pumpen
 RU Сливной шланг для насосов
 CS Výtlačná hadice pro čerpadla
 RO Furtun de evacuare pt. pompe
 HU Elyfolyó tömlő szivattyúhoz
 ES Manguera de salida para bombas



VOREL

No.	L [m]	Diameter / Šrednica	Wall thickness / Grubość ścianki [mm]	
79960	10	1" (25.0 mm)	1.2	15
79962	20	1" (25.0 mm)	1.2	8
79963	30	1" (25.0 mm)	1.2	6
79965	50	1" (25.0 mm)	1.2	3
79968	20	1-1/4" (32.0 mm)	1.4	6
79971	50	1-1/4" (32.0 mm)	1.4	3
79973	20	1-1/2" (38.0 mm)	1.8	4

EN Hose holder
 PL Stojak do węża ogrodowego
 DE Gartenschlauchträger
 RU Барабан для намотки поливочного шланга
 CS Stojan navijeci na zahradní hadici
 RO Suport pt. furtun
 HU Utartódob locsolótömlőhöz
 ES Estante para manguera de jardín

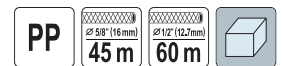

FLO

No.	
89331	5

EN Hose cart
 PL Wózek do węża ogrodowego
 DE Gartenschlauchwagen
 RU Барабан для намотки поливочного шланга
 CS Stojan navjecci na zahradni hadici
 RO Suport pt. furtun
 HU Utartódob locsolótömlőhöz
 ES Carretilla para manguera de jardín



PP
 30 m
 45 m



No.	89335	5
-----	-------	---

EN Hose hanger
 PL Wieszak na wąż ogrodowy
 DE Gartenschlauchträger
 RU Кронштейн настенный для шланга
 CS Věšák na hadici zahradní
 RO Suport de perete pt. furtun
 HU Kertitömlő-akasztó
 ES Colgador para manguera de jardín



ABS



No.	89345	60
-----	-------	----

EN Hand pump
 PL Pompa ręczna
 DE Schwengelpumpe
 RU Насос ручной
 CS Pumpa ruční
 RO Pompa manuala
 HU Kézi szivattyú
 ES Bomba de mano



No.	89552	1
-----	-------	---

EN Dirty water submersible pump
 PL Pompa zatapialna do wody brudnej
 DE Tauchpumpe für Schmutzwasser
 RU Погружной насос для грязной воды
 CS Ponorné čerpadlo pro špinavú vodu
 RO Pompă submersibilă pt. apă murdara
 HU Búvárszivattyú
 ES Bomba sumergible para agua sucia

No.	Power / Moc [W]	Max. capacity / Maks. wydajność [l/h]	Max. head / Maks. wysokość tłoczenia [m]	Icon
79909	400	6000	6	6

EN Hose cart
 PL Wózek do węża ogrodowego
 DE Gartenschlauchwagen
 RU Барабан для намотки поливочного шланга
 CS Stojan navjecci na zahradni hadici
 RO Suport pt. furtun
 HU Utartódob locsolótömlőhöz
 ES Carretilla para manguera de jardín



PP
 45 m
 60 m



No.	89336	5
-----	-------	---

EN Hose guide
 PL Prowadnica węża
 DE Schlauchführung
 RU Направляющее приспособление для шланга
 CS Voditko s rolnami na hadici
 RO Ghidaj pt. furtun
 HU Tömlő vezető
 ES Guidera para manguera



ABS
 19 mm
 25 mm



No.	89348	6/24
-----	-------	------

EN Pump base
 PL Podstawa pod pompę
 DE Pumpenständer
 RU Подставка для насоса
 CS Podstavec pumpy
 RO Suport pt. pompa
 HU Szivattyútálp
 ES Soporte para bomba



No.	For / Dla	1
89553	89552	



230V~50Hz
 400 W
 Q max 6000 l/h
 6.0m
 1" 25mm
 5/4" 32mm
 1.5" 38mm

EN Dirty water submersible pump
 PL Pompa zatapialna do wody brudnej
 DE Tauchmotorpumpe
 RU Погружной насос
 CS Zatavovací čerpadlo
 RO Pompă pt. apă murdară
 HU Búvárszivattyú
 ES Bomba de inmersión para agua sucia



230V~50Hz 1" 25mm
 5/4" 1.5" 32mm 38mm



STNOR

No.	Power / Moc [W]	Max. capacity / Maks. wydajność [l/h]	Max. head / Maks. wysokość tłoczenia [m]	
79781	400	8000	5.5	4
79782	500	10000	6.5	4
79783	600	11500	7.0	4

EN Dirty water submersible pump
 PL Pompa zatapialna do wody brudnej
 DE Tauchmotorpumpe
 RU Погружной насос
 CS Zatavovací čerpadlo
 RO Pompă pt. apă murdară
 HU Búvárszivattyú
 ES Bomba de inmersión para agua sucia



230V~50Hz 1" 25mm
 5/4" 1.5" 32mm 38mm
 INOX

FLO

No.	Power / Moc [W]	Max. capacity / Maks. wydajność [l/h]	Max. head / Maks. wysokość tłoczenia [m]	
79790	750	14000	7.5	2
79791	900	16000	8.5	2
79792	1100	20000	9.0	2

EN Membrane deep well water pump
 PL Pompa membranowa zatapialna
 DE Tauchmotorpumpe
 RU Погружной насос
 CS Zatavovací čerpadlo
 RO Pompă pt. apă cu membrana
 HU Búvárszivattyú
 ES Bomba de diafragma sumergible



220-230V~50Hz 350 W
 Q max 1200 l/h Δ 70m

FLO

No.	Power / Moc [W]	Max. capacity / Maks. wydajność [l/h]	Max. head / Maks. wysokość tłoczenia [m]	
79944	350	1200	70	4

EN Dirty water submersible pump
 PL Pompa zatapialna do wody brudnej
 DE Tauchmotorpumpe
 RU Погружной насос
 CS Zatavovací čerpadlo
 RO Pompă pt. apă murdară
 HU Búvárszivattyú
 ES Bomba de inmersión para agua sucia



230V~50Hz 1" 25mm
 5/4" 1.5" 32mm 38mm

FLO

No.	Power / Moc [W]	Max. capacity / Maks. wydajność [l/h]	Max. head / Maks. wysokość tłoczenia [m]	
79771	400	10000	6.5	4
79772	550	11500	7.0	4
79773	750	14000	7.5	4
79774	900	16000	8.5	4
79775	1100	16000	8.5	4

EN Membrane deep well water pump
 PL Pompa membranowa zatapialna
 DE Tauchmotorpumpe
 RU Погружной насос
 CS Zatavovací čerpadlo
 RO Pompă pt. apă cu membrana
 HU Búvárszivattyú
 ES Bomba de diafragma sumergible



230V~50Hz 280 W
 Q max 1020 l/h Δ 68m

STNOR

No.	Power / Moc [W]	Max. capacity / Maks. wydajność [l/h]	Max. head / Maks. wysokość tłoczenia [m]	
79943	280	1020	68	4

EN Submersible pump for dirty water and wastewater
 PL Pompa zatapialna do wody brudnej i ścieków
 DE Tauchpumpe für Schmutzwasser
 RU Погружной насос для грязной воды
 CS Ponorné čerpadlo pro odpadní vody
 RO Pompă submersibilă pt. apă uzată
 HU Búvárszivattyú szennyvíz
 ES Bomba sumergible para aguas residuales



230V~50Hz 450 W
 Q max 9000 l/h

FLO

No.	Power / Moc [W]	Max. capacity / Maks. wydajność [l/h]	Max. head / Maks. wysokość tłoczenia [m]	
79881	450	9000	10	1

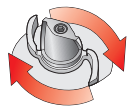

EN Submersible pump for dirty water and wastewater
 PL Pompa zatapialna do wody brudnej i ścieków
 DE Tauchpumpe für Schmutzwasser
 RU Погружной насос для грязной воды
 CS Ponorné čerpadlo pro odpadní vody
 RO Pompă submersibilă pt. apă uzată
 HU Búvárszivattyú szennyvíz
 ES Bomba sumergible para aguas residuales

230V~50Hz 450 W Q max 16000 l/h



No.	Power / Moc [W]	Max. capacity / Maks. wydajność [l/h]	Max. head / Maks. wysokość tłoczenia [m]	
79880	450	16000	9	1

EN Jet pump
 PL Pompa ogrodowa
 DE Gartenpumpe
 RU Насос садовый

CS Zahradní čerpadlo
 RO Pompa apa
 HU Kerti szivattyúhoz
 ES Bomba de jardín con cabeza

230V~50Hz



L_{WA} = 95.0 ± 3.0 dB

No.	Power / Moc [W]	Max. capacity / Maks. wydajność [l/h]	Max. lifting height / Maks. wysokość podnoszenia [m]	Max. pumping pressure / Maks. ciśnienie tłoczenia [bar]	
79810	600	2800	35	3.5	1
79811	800	3600	40	4.0	1
79812	1000	3800	44	4.4	1

EN Fountain pump
 PL Pompa fontanna
 DE Springbrunnenpumpe
 RU Фонтанный насос
 CS Fontánová pumpa
 RO Pompa pt. fantana arteziana
 HU Pumpa szökőkúthoz
 ES Bomba para las fuentes

230V~50Hz 3 NOZZLES DYSE IPX8



No.	Power / Moc [W]	Max. capacity / Maks. wydajność [l/h]	Max. head / Maks. wysokość tłoczenia [m]	
79926	8	600	1.0	12
79927	16	800	1.3	12
79928	22	1000	1.6	12

EN Fountain pump
 PL Pompa fontanna
 DE Springbrunnenpumpe
 RU Фонтанный насос
 CS Fontánová pumpa
 RO Pompa pt. fantana arteziana
 HU Pumpa szökőkúthoz
 ES Bomba para las fuentes

230V~50Hz 5 NOZZLES DYSE IPX8



No.	Power / Moc [W]	Max. capacity / Maks. wydajność [l/h]	Max. head / Maks. wysokość tłoczenia [m]	
79929	28	1400	2.0	8
79930	40	1800	2.5	8

EN Fountain pump
 PL Pompa fontanna
 DE Springbrunnenpumpe
 RU Фонтанный насос
 CS Fontánová pumpa
 RO Pompa pt. fantana arteziana
 HU Pumpa szökőkúthoz
 ES Bomba para las fuentes

230V~50Hz 5 NOZZLES DYSE IP68 10m



No.	Power / Moc [W]	Max. capacity / Maks. wydajność [l/h]	Max. head / Maks. wysokość tłoczenia [m]	
79931	55	2000	2.5	8
79932	85	3000	3.5	8
79933	100	4500	4.5	6

EN Round irrigation valve box
 PL Okrągła skrzynka zaworowa ogrodowa
 DE Rundes Gartenventilgehäuse
 RU Круглый садовый вентиляный ящик
 CS Kulatý zahradní ventilový box
 RO Cutie rotundă de supapă de irigare
 HU Kerek kerti szelepdoboz
 ES Caja redonda para válvulas, jardín

∅ 265 340 x260(H) mm PP



No.	
88780	10

EN Irrigation valve box
 PL Skrzynka zaworowa ogrodowa
 DE Gartenventilgehäuse
 RU Садовый вентиляный ящик
 CS Zahradní ventilový box
 RO Cutie cu supape pt. irigat
 HU Kerti szelepdoboz
 ES Caja para válvulas, jardín

420x290 520x390 x320(H) mm PP



No.	
88783	4

EN Irrigation valve box
 PL Skrzynka zaworowa ogrodowa
 DE Gartenventilgehäuse
 RU Садовый вентиляционный ящик
 CS Zahradní ventilový box
 RO Cutie cu supape pt. irigație
 HU Kerti szelepdoboz
 ES Caja para válvulas, jardín



No.		
88784		2

EN Adapter - pipe plug
 PL Záslepka do rur
 DE Rohrstopfen
 RU Заглушка для труб
 CS Záslepka do trubek
 RO Adaptor - conector teava
 HU Elzáró sapka csőhöz
 ES Tapa de tubos

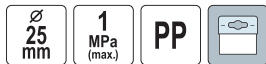

No.	Water outlet diameter / Šířka přilučka vody [mm]	
88853	25	50/200

EN Adapter 90°
 PL Kolanko do rur
 DE Rohrkümmer
 RU Колено для труб
 CS Trubkový ohyb
 RO Adaptor 90°
 HU Derékszög csőhöz
 ES Codo para tubos

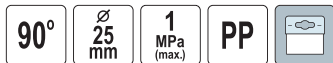

No.	Water outlet diameter / Šířka přilučka vody [mm]	
88856	25x25	50/200

EN Adapter
 PL Złączka do rur
 DE Rohrverbindung
 RU Ниппель для труб
 CS Trubková spojka
 RO Adaptor
 HU Csatlakozó csőhöz
 ES Conector de tubos

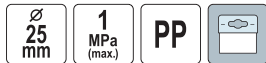

No.	Water outlet diameter / Šířka přilučka vody [mm]	
88858	25x25	50/200

EN Adapter
 PL Złączka do rur
 DE Rohrverbindung
 RU Ниппель для труб
 CS Trubková spojka
 RO Adaptor
 HU Csatlakozó csőhöz
 ES Conector de tubos



No.	Connector thread size / Rozmiar gwintu przyłącza	Water outlet diameter / Šířka přilučka vody [mm]	
88850	G3/4 (M)	25	50/200

EN Adapter
 PL Trójnik
 DE T-Stück
 RU Тройник
 CS Rozdělovač
 RO Adaptor
 HU Hármás elosztó
 ES Tubos en T



No.	Connector thread size / Rozmiar gwintu przyłącza	Water outlet diameter / Šířka přilučka vody [mm]	
88855	G3/4 (F)	25x25	50/200

EN Adapter 90°
 PL Kolanko do rur
 DE Rohrkümmer
 RU Колено для труб
 CS Trubkový ohyb
 RO Adaptor 90°
 HU Derékszög csőhöz
 ES Codo para tubos



No.	Connector thread size / Rozmiar gwintu przyłącza	Water outlet diameter / Šířka přilučka vody [mm]	
88857	G3/4 (F)	25	50/200

EN Adapter
 PL Trójnik
 DE T-Stück
 RU Тройник
 CS Rozdělovač
 RO Adaptor
 HU Hármás elosztó
 ES Tubos en T



No.	Connector thread size / Rozmiar gwintu przyłącza	Water outlet diameter / Šířka přilučka vody [mm]	
88860	G1 (M)	25x25	50/200

EN Adapter
 PL Trójnik
 DE T-Stück
 RU Тройник
 CS Rozdělovač
 RO Adaptor
 HU Hármás elosztó
 ES Tubos en T



No.	Connector thread size / Rozmiar gwintu przyłącza	Water outlet diameter / Średnica przyłącza wody [mm]	
88861	G3/4 (M)	25x25	50/200

EN Adapter
 PL Trójnik
 DE T-Stück
 RU Тройник
 CS Rozdělovač
 RO Adaptor
 HU Hármás elosztó
 ES Tubos en T



No.	Connector thread size / Rozmiar gwintu przyłącza	Water outlet diameter / Średnica przyłącza wody [mm]	
88863	G1 (F)	25x25	50/200

EN Adapter 90°
 PL Kolanko do rur
 DE Rohrkrümmmer
 RU Колено для труб
 CS Trubkový ohyb
 RO Adaptor 90°
 HU Derékszög csőhöz
 ES Codo para tubos



No.	Connector thread size / Rozmiar gwintu przyłącza	Water outlet diameter / Średnica przyłącza wody [mm]	
88870	G1 (M)	25	50/200

EN Water filter
 PL Filtr wody
 DE Wasserfilter
 RU Фильтр очистки воды
 CS Vodní filtr
 RO Filtru apă
 HU Vízszűrő
 ES Filtro de agua



No.	Connector thread size / Rozmiar gwintu przyłącza	
88930	G3/4 BSP (M)	24

EN Adapter
 PL Trójnik
 DE T-Stück
 RU Тройник
 CS Rozdělovač
 RO Adaptor
 HU Hármás elosztó
 ES Tubos en T



No.	Connector thread size / Rozmiar gwintu przyłącza	Water outlet diameter / Średnica przyłącza wody [mm]	
88862	G1/2 (M)	25x25	50/200

EN Adapter
 PL Trójnik
 DE T-Stück
 RU Тройник
 CS Rozdělovač
 RO Adaptor
 HU Hármás elosztó
 ES Tubos en T



No.	Connector thread size / Rozmiar gwintu przyłącza	Water outlet diameter / Średnica przyłącza wody [mm]	
88864	G1/2 (F)	25x25	50/200

EN Adapter 90°
 PL Kolanko do rur
 DE Rohrkrümmmer
 RU Колено для труб
 CS Trubkový ohyb
 RO Adaptor 90°
 HU Derékszög csőhöz
 ES Codo para tubos



No.	Connector thread size / Rozmiar gwintu przyłącza	Water outlet diameter / Średnica przyłącza wody [mm]	
88871	G1/2 (M)	25	50/200

EN Water filter
 PL Filtr wody
 DE Wasserfilter
 RU Фильтр очистки воды
 CS Vodní filtr
 RO Filtru apă
 HU Vízszűrő
 ES Filtro de agua

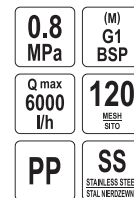

No.	Connector thread size / Rozmiar gwintu przyłącza	
88931	G1 BSP (M)	24

EN Water filter
 PL Filtr wody
 DE Wasserfilter
 RU Фильтр очистки воды
 CS Vodní filtr
 RO Filtru apa
 HU Vízsűrű
 ES Filtro de agua



0.8 MPa (M) G1 1/2 BSP
 Q max 12000 l/h **130 µm**
PP



No.	Connector thread size / Rozmiar gwintu przyłącza	
88932	G1-1/2 BSP (M)	9

EN Filter element of screen filter
 PL Wkład siatkowy do filtra wody
 DE Mascheneinsatz für Wasserfilter
 RU Сетчатый картридж для фильтра очистки воды
 CS Síťovaná vložka vodního filtru
 RO Sita filtru
 HU Hálós betét vízsűrűbe
 ES Cartucho de malla para filtro de agua



(M) G3/4 BSP (M) G1 BSP
120 µm **PP**
SS STAINLESS STEEL / STAL NIEODŻYWIANA

For 88930, 88931
 Dla 88930, 88931



No.	Connector thread size / Rozmiar gwintu przyłącza	For / Dla	
88935	G3/4 BSP (M), G1 BSP (M)	88930, 88931	144

EN Filter element of disc filter
 PL Wkład dyskowy do filtra wody
 DE Scheibenfiltereinsatz für Wasserfilter
 RU Дисковый картридж для фильтра очистки воды
 CS Disková vložka do vodního filtru
 RO Disc filtru
 HU Lemezes betét vízsűrűbe
 ES Cartucho de disco para filtro de agua



(M) G3/4 (M) G1
130 µm **PP**

For 88930, 88931
 Dla 88930, 88931



No.	Connector thread size / Rozmiar gwintu przyłącza	For / Dla	
88938	G3/4 BSP (M), G1 BSP (M)	88930, 88931	144

EN By-pass pruner
 PL Sekator uniwersalny
 DE Rebenschere
 RU Секатор
 CS Nožnice zahradnícke
 RO Foarfece pt. pomi
 HU Metszőolló
 ES Podadera universal

180 mm $\varnothing 10\text{mm}$



No.	L [mm]	
99193	180	12/120

EN Water filter
 PL Filtr wody
 DE Wasserfilter
 RU Фильтр очистки воды
 CS Vodní filtr
 RO Filtru apa
 HU Vízsűrű
 ES Filtro de agua



0.8 MPa (M) G2 BSP
 Q max 22000 l/h **130 µm**
PP



No.	Connector thread size / Rozmiar gwintu przyłącza	
88933	G2 BSP (M)	9

EN Filter element of screen filter
 PL Wkład siatkowy do filtra wody
 DE Mascheneinsatz für Wasserfilter
 RU Сетчатый картридж для фильтра очистки воды
 CS Síťovaná vložka vodního filtru
 RO Sita filtru
 HU Hálós betét vízsűrűbe
 ES Cartucho de malla para filtro de agua



(M) G1 1/2 BSP (M) G2 BSP
120 µm **PP**
SS STAINLESS STEEL / STAL NIEODŻYWIANA

For 88932, 88933
 Dla 88932, 88933



No.	Connector thread size / Rozmiar gwintu przyłącza	For / Dla	
88936	G1-1/2 BSP (M), G2 BSP (M)	88932, 88933	32

EN Filter element of disc filter
 PL Wkład dyskowy do filtra wody
 DE Scheibenfiltereinsatz für Wasserfilter
 RU Дисковый картридж для фильтра очистки воды
 CS Disková vložka do vodního filtru
 RO Disc filtru
 HU Lemezes betét vízsűrűbe
 ES Cartucho de disco para filtro de agua



(M) G1 1/2 BSP (M) G2 BSP
130 µm **PP**

For 88932, 88933
 Dla 88932, 88933



No.	Connector thread size / Rozmiar gwintu przyłącza	For / Dla	
88939	G1-1/2 BSP (M), G2 BSP (M)	88932, 88933	32

EN By-pass pruner
 PL Sekator uniwersalny
 DE Rebenschere
 RU Секатор
 CS Nožnice zahradnícke
 RO Foarfece pt. pomi
 HU Metszőolló
 ES Podadera universal

190 mm $\varnothing 15\text{mm}$



No.	L [mm]	
99194	190	12/120

EN By-pass pruner
 PL Sekator uniwersalny
 DE Rebenschere
 RU Cекaтop
 CS Nožnice zahradnicke
 RO Foarfece pt. pomi
 HU Metszőolló
 ES Podadera universal



No.	L [mm]	
99230	200	20/60

EN By-pass pruner
 PL Sekator uniwersalny
 DE Rebenschere
 RU Cекaтop
 CS Nožnice zahradnicke
 RO Foarfece pt. pomi
 HU Metszőolló
 ES Podadera universal



No.	L [mm]	
99209	215	6/48

EN By-pass pruner
 PL Sekator uniwersalny
 DE Rebenschere
 RU Cекaтop
 CS Nožnice zahradnicke
 RO Foarfece pt. pomi
 HU Metszőolló
 ES Podadera universal



No.	L [mm]	
99203	205	20/60

EN By-pass pruner
 PL Sekator uniwersalny
 DE Rebenschere
 RU Cекaтop
 CS Nožnice zahradnicke
 RO Foarfece pt. pomi
 HU Metszőolló
 ES Podadera universal



No.	L [mm]	
99208	200	12/60

EN By-pass pruner
 PL Sekator uniwersalny
 DE Rebenschere
 RU Cекaтop
 CS Nožnice zahradnicke
 RO Foarfece pt. pomi
 HU Metszőolló
 ES Podadera universal



No.	L [mm]	
99190	200	18/72

EN By-pass pruner
 PL Sekator uniwersalny
 DE Rebenschere
 RU Cекaтop
 CS Nožnice zahradnicke
 RO Foarfece pt. pomi
 HU Metszőolló
 ES Podadera universal



No.	L [mm]	
99202	180	18/72

EN By-pass pruner
 PL Sekator uniwersalny
 DE Rebenschere
 RU Cекaтop
 CS Nožnice zahradnicke
 RO Foarfece pt. pomi
 HU Metszőolló
 ES Podadera universal



No.	L [mm]	
99204	220	20/60

EN By-pass pruner
 PL Sekator uniwersalny
 DE Rebenschere
 RU Cекaтop
 CS Nožnice zahradnicke
 RO Foarfece pt. pomi
 HU Metszőolló
 ES Podadera universal



No.	L [mm]	
99206	210	20/60

EN Professional anvil pruner
 PL Sekator kowadełkowy
 DE Amboss-Gartenschere
 RU Секатор
 CS Nožnice zahradnícke
 RO Foarfece pt. pomi
 HU Metszőolló
 ES Podadera de bigornia



No.	L [mm]	Box
99207	205	20/60

EN By-pass pruners set
 PL Zestaw sekatorów
 DE Scherenset
 RU Набор ножниц
 CS Zahradnické nůžky sada
 RO Set de foarfece pt. pomi
 HU Metszős olló készlet
 ES Juego de tijeras



No.	L [mm]	Box
99195	150	24

EN Flower shears
 PL Nożyce florystyczne
 DE Blumenschere
 RU Цветочные ножницы
 CS Květinové nůžky
 RO Foarfece de grădină
 HU Virág ollók
 ES Tijeras de podar



No.	L [mm]	Box
99181	145	12/120

EN Flower shears
 PL Nożyce florystyczne
 DE Blumenschere
 RU Цветочные ножницы
 CS Květinové nůžky
 RO Foarfece de grădină
 HU Virág ollók
 ES Tijeras de podar



No.	L [mm]	Box
99182	165	12/120

EN Professional anvil pruner
 PL Sekator kowadełkowy
 DE Amboss-Gartenschere
 RU Секатор
 CS Nožnice zahradnícke
 RO Foarfece pt. pomi
 HU Metszőolló
 ES Podadera de bigornia



No.	L [mm]	Box
99191	200	18/72

EN Fruit and flower shears
 PL Sekator do obcinania zawiązków
 DE Blumen- und Rebschere
 RU Секатор
 CS Nožnice zahradnícke
 RO Foarfece pt. pomi
 HU Metszőolló
 ES Podadera para cortar germenés



No.	L [mm]	Box
99240	190	12/72

EN Flower shears
 PL Nożyce florystyczne
 DE Blumenschere
 RU Цветочные ножницы
 CS Květinové nůžky
 RO Foarfece de grădină
 HU Virág ollók
 ES Tijeras de podar



No.	L [mm]	Box
99180	170	12/120

EN By-pass lopping shears
 PL Sekator do gałęzi
 DE Astschere
 RU Сучкорез
 CS Nožnice zahradnícke
 RO Foarfece curbata pt. taiat crengi
 HU Ágvágó fix
 ES Podadera para ramas



No.	L [mm]	Box
99101	430	12

EN By-pass lopping shears
 PL Sekator do gałęzi
 DE Astschere
 RU Сучкорез
 CS Nožnice zahradnícké
 RO Foarfeca curbata pt. taiat crengii
 HU Ágvágó fix
 ES Podadera para ramas

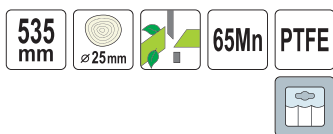

No.	L [mm]	
99103	535	12

EN By-pass lopping shears
 PL Sekator do gałęzi
 DE Astschere
 RU Сучкорез
 CS Nožnice zahradnícké
 RO Foarfeca curbata pt. taiat crengii
 HU Ágvágó fix
 ES Podadera para ramas

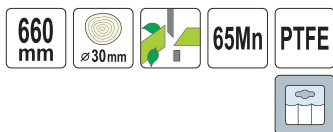

No.	L [mm]	
99109	660	12

EN By-pass lopping shears
 PL Sekator do gałęzi
 DE Astschere
 RU Сучкорез
 CS Nožnice zahradnícké
 RO Foarfeca curbata pt. taiat crengii
 HU Ágvágó fix
 ES Podadera para ramas

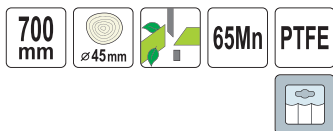

No.	L [mm]	
99111	700	12

EN Telescopic by-pass lopping shears
 PL Teleskopowy sekator do konarów
 DE Astschere
 RU Секатор с телескопическими ручками
 CS Nožnice zahradnícké na hrubé konáre
 RO Foarfeca taiat crengii
 HU Ágvágó teleszkópos
 ES Podadera para ramas telescopico

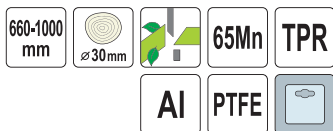

No.	L [mm]	
99114	660-1000	12

EN By-pass lopping shears
 PL Sekator do gałęzi
 DE Astschere
 RU Сучкорез
 CS Nožnice zahradnícké
 RO Foarfeca curbata pt. taiat crengii
 HU Ágvágó fix
 ES Podadera para ramas

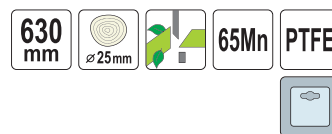

No.	L [mm]	
99104	630	12

EN By-pass lopping shears
 PL Sekator do gałęzi
 DE Astschere
 RU Сучкорез
 CS Nožnice zahradnícké
 RO Foarfeca curbata pt. taiat crengii
 HU Ágvágó fix
 ES Podadera para ramas

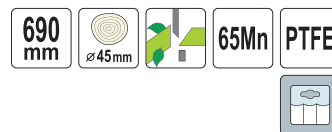

No.	L [mm]	
99116	690	12

EN Telescopic by-pass lopping shears
 PL Teleskopowy sekator do konarów
 DE Astschere
 RU Секатор с телескопическими ручками
 CS Nožnice zahradnícké na hrubé konáre
 RO Foarfeca taiat crengii
 HU Ágvágó teleszkópos
 ES Podadera para ramas telescopico

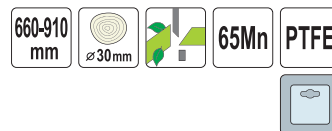

No.	L [mm]	
99119	660-910	12

EN Telescopic by-pass lopping shears
 PL Teleskopowy sekator do konarów
 DE Astschere
 RU Секатор с телескопическими ручками
 CS Nožnice zahradnícké na hrubé konáre
 RO Foarfeca taiat crengii
 HU Ágvágó teleszkópos
 ES Podadera para ramas telescopico

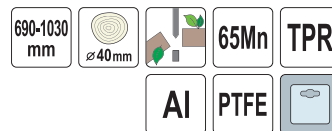

No.	L [mm]	
99113	690-1030	6

EN By-pass lopping shears
 PL Sekator do gałęzi
 DE Astschere
 RU Сучкорез
 CS Nožnice zahradnicke
 RO Foarfeca curbata pt. taiat crengi
 HU Ágvágó fix
 ES Podadera para ramas



No.	L [mm]	Icon
99115	620-940	12

EN By-pass lopping shears
 PL Sekator do gałęzi
 DE Astschere
 RU Сучкорез
 CS Nožnice zahradnicke
 RO Foarfeca curbata pt. taiat crengi
 HU Ágvágó fix
 ES Podadera para ramas



No.	L [mm]	Icon
99112	690	12

EN Telescopic handle
 PL Przedłużka teleskopowa
 DE Teleskopstange
 RU Рукотятка телескопическая

CS Teleskopický prodlužovač
 RO Prelungitor telescopic
 HU Teleszkópos hosszabbító
 ES Tubo de prolongación telescópico



No.	L [mm]	Icon
99315	1300-2370	12

EN Hedge shears
 PL Nożyce do żywoplotu
 DE Heckenschere
 RU Кусторезы
 CS Nožnice na živý plot
 RO Foarfeca pt. gard viu
 HU Sívényvágó olló
 ES Tijeras para seto vivo



No.	L [mm]	Icon
99005	550	20

EN By-pass lopping shears
 PL Sekator do gałęzi
 DE Astschere
 RU Сучкорез
 CS Nožnice zahradnicke
 RO Foarfeca curbata pt. taiat crengi
 HU Ágvágó fix
 ES Podadera para ramas



No.	L [mm]	Icon
99110	660	12

EN Leverage tree pruner
 PL Sekator gasienicowy z piłą
 DE Baumsäge mit Astschere
 RU Сучкорез штанговый с пилой
 CS Stříhač na větve s pilovým listem
 RO Fierastrau pt. pomi cu prelungitor
 HU Kőteles ágvágó
 ES Podadera de palanca con sierra



No.	L [mm]	Icon
99310	330	12/24

EN Hedge shears
 PL Nożyce do żywoplotu
 DE Heckenschere
 RU Кусторезы
 CS Nožnice na živý plot
 RO Foarfeca pt. gard viu
 HU Sívényvágó olló
 ES Tijeras para seto vivo



No.	L [mm]	Icon
99001	415	12

EN Hedge shears
 PL Nożyce do żywoplotu
 DE Heckenschere
 RU Кусторезы
 CS Nožnice na živý plot
 RO Foarfeca pt. gard viu
 HU Sívényvágó olló
 ES Tijeras para seto vivo



No.	L [mm]	Icon
99006	630	12

EN Hedge shears
 PL Nożyce do żywoplotu
 DE Heckenscherre
 RU Кусторезы
 CS Nožnice na živý plot
 RO Foarfeca pt. gard viu
 HU Sövényvágó olló
 ES Tijeras para seto vivo



No.	L [mm]	Blade length / Długość ostrza [mm]	
99007	590	185	18
99008	620	215	18

EN Grass shears
 PL Nożyce do trawy wielopozycyjne
 DE Handgrasschere
 RU Ножницы для стрижки травы
 CS Nožnice na trávu
 RO Foarfeca pt. gazon
 HU Forgatható fűnyíró olló
 ES Tijeras de cesped

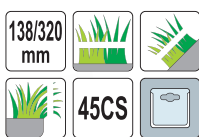

No.	L [mm]	
99300	320	12/48

EN Pruning saw
 PL Pila ogrodnicza - lisi ogon
 DE Baumsäge
 RU Пила садовая

CS Zahradnická pila - liščí ocas
 RO Fierăstrău de grădină - coadă de vulpe
 HU Gallyazófűrész-róka farkú
 ES Sierra de jardín - cola de zorro



No.	L [mm]	
28640	250	12/120

EN Pruning saw
 PL Pila do gałęzi z kaburą
 DE Baumsäge
 RU Пила садовая
 CS Zahradnická pila
 RO Fierăstrău pt. perforare
 HU Gallyazófűrész
 ES Sierra de jadin

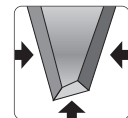

No.	L [mm]	
28642	300	12/36

EN Hedge shears
 PL Nożyce do żywoplotu
 DE Heckenscherre
 RU Кусторезы
 CS Nožnice na živý plot
 RO Foarfeca pt. gard viu
 HU Sövényvágó olló
 ES Tijeras para seto vivo



No.	L [mm]	
99009	650-860	12

EN Grass shears
 PL Nożyce do trawy wielopozycyjne
 DE Handgrasschere
 RU Ножницы для стрижки травы
 CS Nožnice na trávu
 RO Foarfeca pt. gazon
 HU Forgatható fűnyíró olló
 ES Tijeras de cesped



No.	L [mm]	
99301	300	12/48

EN Pruning saw
 PL Pila do gałęzi składana
 DE Baumsäge
 RU Пила садовая

CS Zahradnická pila
 RO Fierăstrău pt. perforare
 HU Gallyazófűrész
 ES Sierra para ramos plegable

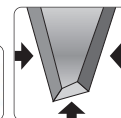

No.	L [mm]	
28641	180	20/60

EN Bow saw
 PL Pila kabłąkowa
 DE Bügelsäge
 RU Лучковая пила по дереву

CS Oblouková pila
 RO Ferăstrău de curbură
 HU Keretes fűrész
 ES Sierra de arco



No.	L [mm]	
28740	525	24
28750	750	24

EN Bow saw
 PL Piła kabląkowa
 DE Bügelsäge
 RU Лучковая пила по дереву
 CS Oblouková píla
 RO Ferăstrău de curbură
 HU Keretes fűrész
 ES Sierra de arco



FLO

No.	L [mm]	
28745	530	12/24

EN Spare blade for bow saw
 PL Brzeszczot
 DE Bügelsägeblatt
 RU Полотно для лучковой пилы по сырому дереву
 CS Ostří na dřevo
 RO Panza fierastrau tip arc
 HU Fűrészlap fához
 ES Hoja de sierra



FLO

No.	L [mm]	W [mm]	
28771	530	20	60/240
28772	610	20	60/240
28773	760	20	60/240

EN Axe
 PL Siekiera
 DE Handbeil
 RU Топор

CS Sekyřka
 RO Toporișca
 HU Szekeřce
 ES Hacha

FLO

No.	m [g]	
33067	600	24
33087	800	20
33107	1000	12
33127	1250	12
33147	1400	12
33177	1600	12

EN Axe
 PL Siekiera
 DE Handbeil
 RU Топор

CS Sekera
 RO Secure
 HU Szekeřce
 ES Hacha



FLO

No.	m [g]	
32930	1000	10

EN Bow saw
 PL Piła kabląkowa
 DE Bügelsäge
 RU Лучковая пила по дереву

CS Oblouková píla
 RO Ferăstrău de curbură
 HU Keretes fűrész
 ES Sierra de arco



FLO

No.	L [mm]	
28746	610	12/24
28755	760	12/24

EN Drop forged hatchet
 PL Siekiera ze stali kutej
 DE Handbeil
 RU Топор кованный

CS Sekera ocelová kovaná
 RO Toporișca lama forjată
 HU Kovácsolt acél fejű szekeřce
 ES Hacha de metalo forjado



FLO

No.	m [g]	
33080	800	12/24



EN Axe with fibreglass + PVC handle
 PL Siekiera, rączka z włókna szklanego
 DE Handbeil Fiberglasstiel
 RU Топор с фиберглассовой ручкой

CS Sekyřka
 RO Toporișca cu coada din fibra de sticlă
 HU Szekeřce
 ES Hacha con mango de fibra de vidrio



VOREL

No.	m [g]	
33065	600	20
33085	800	20
33105	1000	12
33125	1250	6

EN Axe
PL Siekiera
DE Handbeil
RU Топор

CS Sekyrka
RO Toporisca
HU Szekeerce
ES Hacha

DIN
5131
7294



JUCO

No.	m [g]	DIN	
33024	400	5131	5
33026	600	5131	5
33028	800	5131	5
33030	1000	5131	5
33032	1250	7294	5
33035	1500	7294	5
33038	1800	7294	5
33039	2000	7294	5
33040	2500	7294	5

EN Axe
PL Siekiera
DE Handbeil
RU Топор

CS Sekyrka
RO Toporisca
HU Szekeerce
ES Hacha

DIN
5131
7294



JUCO

No.	m [g]	DIN	
33000	400	5131	5
33001	600	5131	5
33002	800	5131	5
33003	1000	5131	5
33004	1250	7294	5
33005	1500	7294	5
33006	1800	7294	5
33007	2000	7294	5
33008	2500	7294	5

EN Axe set
PL Zestaw siekier tradycyjnych
DE Satz traditioneller Äxte
RU Набор традиционных топоров

CS Sada klasických seker
RO Set topoare
HU Hagymányos balta készlet
ES Set de hechas tradicionales



JUCO

No.	m [kg]	
32999	0.4, 1.5	5

EN Axe
PL Siekiera z klinem
DE Handbeil
RU Топор

CS Sekerka
RO Secure
HU Szekeerce
ES Hacha



JUCO

No.	m [kg]	
32924	2	5

EN Hammer-axe for wood splitting
PL Siekiero-młot
DE Spaltaxt
RU Топор-колун

CS Sekera-kladivo
RO Secure-ciocan
HU Szekeerce-kalapács
ES Hacha martillo para partir madera



JUCO

No.	m [kg]	
32925	2.5	1
32926	4.0	1

EN Hammer-axe for wood splitting
PL Siekiero-młot
DE Spaltaxt
RU Топор-колун

CS Sekera-kladivo
RO Secure-ciocan
HU Szekeerce-kalapács
ES Hacha martillo para partir madera



JUCO

No.	m [kg]	
32927	2.1	1
32928	3.2	1

EN Canadian axe
PL Siekiera kanadyjska
DE Handbeil „Kanadische Form“
RU Топор канадского типа

CS Sekera kanadská
RO Topor canadian
HU Hosszú nyelű, hasító fejsze
ES Hacha canada

1.8
kg



JUCO

No.	m [kg]	
33022	1.8	5

EN Hammer wedges
 PL Zestaw klinujący
 DE Keilesatz
 RU Набор клинов
 CS Sada klínků
 RO Set cultivator
 HU Ékelő készlet
 ES Juego de sujeción

10
 PCS

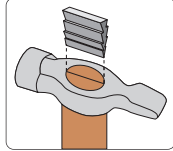

VOREL

No.	pcs / szt.	
99472	10	6/72

EN Hammer wedges
 PL Zestaw klinujący
 DE Keilesatz
 RU Набор клинов
 CS Sada klínků
 RO Set cultivator
 HU Ékelő készlet
 ES Juego de sujeción



JUCO

No.	For hammer / Do młotka [kg]	For axe / Do siekiery [kg]	
99463	5-6	0.6-1.0	50
99464	8-10	1.2-2.5	50

EN Transplanter
 PL Łopátka
 DE Blumenkelle
 RU Совок посадочный
 CS Lopátka
 RO Mini-lopată gradinarit
 HU Ásó
 ES Paleta estrecha

350
 mm



FLO

No.	L [mm]	
99048	350	25/100

EN Rake
 PL Grabki
 DE Blumenrechen
 RU Грабли
 CS Hřabičky
 RO Mini grebla
 HU Cereblye
 ES Rastrillo

300
 mm



FLO

No.	L [mm]	
99051	300	25/100

EN Hammer wedges
 PL Zestaw klinujący
 DE Keilesatz
 RU Набор клинов
 CS Sada klínků
 RO Set cultivator
 HU Ékelő készlet
 ES Juego de sujeción

10
 PCS



JUCO

No.	For hammer / Do młotka [kg]	For axe / Do siekiery	
99460	0.1-0.5	-	50
99461	0.7-2.0	-	50
99462	3.0-4.0	0.4	50

EN Wood splitter
 PL Klin do rozłupywania drewna
 DE Spaltkeil
 RU Клин для раскалывания бревен

CS Klín na štípání polen
 RO Pana pt. lemn
 HU Fahasító ék
 ES Cuiña para partir madera

350
 mm



JUCO

No.	m [kg]	
32922	2	1
32923	3	1

EN Transplanter
 PL Łopátka
 DE Blumenkelle
 RU Совок посадочный
 CS Lopátka
 RO Mini-lopată gradinarit
 HU Ásó
 ES Paleta estrecha

350
 mm



FLO

No.	L [mm]	
99047	350	25/100

EN Hoe and cultivator
 PL Motyczka z pazurkami
 DE Kleinhacke
 RU Рыхлитель комбинированный
 CS Motyčka s kultivátorem
 RO Cultivator cu sapaliga
 HU Kerti villás kapa
 ES Escarificador y azadilla

300
 mm



FLO

No.	L [mm]	
99050	300	50

EN Hoe
 PL Motyczka
 DE Garten Handhacke
 RU Мотыжка
 CS Motyčka
 RO Sapaliga
 HU Kerti kapa
 ES Azadilla

300 mm



FLO

No.	L [mm]	
99052	300	100

EN Transplanter
 PL Łopátka
 DE Blumenkelle
 RU Сокос посадочный
 CS Lopátka
 RO Mini-lopata gradinarit
 HU Ásó
 ES Paleta estrecha

320 mm



FLO

No.	L [mm]	
35765	320	50

EN Cultivator
 PL Pazurki
 DE Grubber
 RU Рыхлитель
 CS Kultivátor
 RO Cultivator
 HU Kultivátor
 ES Escarifi cador

330 mm



FLO

No.	L [mm]	
35767	330	50

EN Transplanter
 PL Łopátka
 DE Blumenkelle
 RU Сокос посадочный
 CS Lopátka
 RO Mini-lopata gradinarit
 HU Ásó
 ES Paleta estrecha

330 mm



FLO

No.	L [mm]	
99035	330	24/48

EN Cultivator
 PL Pazurki
 DE Grubber
 RU Рыхлитель
 CS Kultivátor
 RO Cultivator
 HU Kultivátor
 ES Escarifi cador

310 mm



FLO

No.	L [mm]	
99049	310	25/100

EN Hoe
 PL Motyczka
 DE Garten Handhacke
 RU Мотыжка
 CS Motyčka
 RO Sapaliga
 HU Kerti kapa
 ES Azadilla

350 mm



FLO

No.	L [mm]	
35768	350	50

EN Transplanter
 PL Łopátka
 DE Blumenkelle
 RU Сокос посадочный
 CS Lopátka
 RO Mini-lopata gradinarit
 HU Ásó
 ES Paleta estrecha

330 mm



FLO

No.	L [mm]	
99034	330	24/48

EN Rake
 PL Grabki
 DE Blumenrechen
 RU Грабли
 CS Hraňičky
 RO Mini grebla
 HU Gereblye
 ES Rastrillo

300 mm



FLO

No.	L [mm]	
99036	300	24/48

EN Hoe and cultivator
 PL Motyczka z pazurkami
 DE Kleinhacke
 RU Рыхлитель комбинированный
 CS Motyčka s kultivátorem
 RO Cultivator cu sapaliga
 HU Kerti villás kapa
 ES Escarificador y azadilla

300 mm



FLO

No.	L [mm]	
99037	300	24/48

EN Garden rake
 PL Grabki wachlarzowe
 DE Landschaftsbesen
 RU Грабли веерные
 CS Hrabíčky
 RO Grebla de gradina
 HU Kerti gereblye
 ES Rastrillo de abanico de hojalata

450 mm



FLO

No.	L [mm]	
99039	450	24/48

EN Bulb planter
 PL Sadzarka do cebuli
 DE Blumenzweibelpflanzer
 RU Конус посадочный для рассады
 CS Sázeč
 RO Plantator
 HU Palántázó
 ES Plantadora para cebollas



FLO

No.		
99033		10/60

EN Multifunctional shovel
 PL Saperka wielofunkcyjna
 DE Kombi-Faltschaufel
 RU Салёрная лопата многофункциональная
 CS Lopatka víceúčelová
 RO Lopata multifunctionala
 HU Többfunkciós ásó
 ES Zapadora multifuncion



FLO

No.		
99053		36

EN Cultivator
 PL Pazurki
 DE Grubber
 RU Рыхлитель
 CS Kultivátor
 RO Cultivator
 HU Kultivátor
 ES Escarifi cador

395 mm



FLO

No.	L [mm]	
99038	395	24/48

EN Patio weeder
 PL Chwastownik
 DE Fugenkratzer
 RU Очиститель щелевой
 CS Čistič mezer
 RO Cuițit pt. curățat dale
 HU Fugakaparó
 ES Musgo cuchillo

320 mm



FLO

No.	L [mm]	
99040	320	24/48

EN Fruit pick up tool
 PL Zbierak do owoców
 DE Obstpflücker
 RU Съемник для фруктов
 CS Sběrač ovoce
 RO Culegator pt. fructe
 HU Karos gyümölcszedő
 ES Recojedor de frutas



FLO

No.	Ø [mm]	
89880	160	12/48

EN Folding shovel
 PL Saperka składana
 DE Faltschaufel
 RU Салёрная лопата складная
 CS Lopatka skládací
 RO Lopata demontabila
 HU Összecsukható ásó
 ES Zapadora desmontable



FLO

No.		
99054		36

EN Garden tool set
 PL Komplet narzędzi ogrodowych
 DE Garten-Kleingerätesatz
 RU Набор садово-огородного инструмента

CS Sada zahradnického náčiní
 RO Set pt. grădinarit
 HU Kertész készlet
 ES Juego de herramientas de jardín



No.	L [mm]	
99028	205	50

EN Garden roller
 PL Walec ogrodowy
 DE Gartenwalze
 RU Садовый валик
 CS Zahradní váleček
 RO Tavalug gradina
 HU Kerti henger
 ES Rodillo de jardín



No.	Working part width / Szerokość części roboczej [mm]	
88720	500	1

EN Flat spade
 PL Szpadel prosty
 DE Rodespaten
 RU Заступ
 CS Rýč rovný
 RO Hârleț cu coadă
 HU Egyenes ásó
 ES Pala de jardín recta



No.	Handle type / Typ trzonka	
35809	DY	200

EN Flat spade
 PL Szpadel prosty
 DE Rodespaten
 RU Заступ
 CS Rýč rovný
 RO Hârleț cu coadă
 HU Egyenes ásó
 ES Pala de jardín recta



No.	Handle type / Typ trzonka	
35836	DY	6

EN Garden tool set
 PL Komplet narzędzi ogrodowych
 DE Garten-Kleingerätesatz
 RU Набор садово-огородного инструмента

CS Sada zahradnického náčiní
 RO Set pt. grădinarit
 HU Kertész készlet
 ES Juego de herramientas de jardín



No.	pcs / szt.	
99056	4	10/60

EN Transplanting spade
 PL Szpadel szkółkarski
 DE Baumschulspaten
 RU Лопата для саженцев
 CS Školkařský rýč
 RO Cazma pt. plantat
 HU Faiskolai ásó
 ES Pala de vivero



No.	Handle type / Typ trzonka	
35811	DY	140

EN Flat spade
 PL Szpadel prosty
 DE Rodespaten
 RU Заступ
 CS Rýč rovný
 RO Hârleț cu coadă
 HU Egyenes ásó
 ES Pala de jardín recta



No.	Handle type / Typ trzonka	
35720	DY	140

EN Sharp spade
 PL Szpadel ostry
 DE Scharfer Spaten
 RU Острая лопата
 CS Rýč špičatý
 RO Hârleț ascuțit
 HU Hegyes ásó
 ES Pala de jardín puntiaguda



No.	Handle type / Typ trzonka	
35810	DY	200

EN Sharp spade
 PL Szpadel ostry
 DE Scharfer Spaten
 RU Острая лопата
 CS Ryč špičatý
 RO Hârleț ascuțit
 HU Hegyes ásó
 ES Pala de jardín puntiaguda



HRC 45 DY



No.	Handle type / Typ trzonka	
35721	DY	140

EN Mini shovel
 PL Łopata profilowana
 DE Feldspaten
 RU Лопата саперная
 CS Vojenská lopata
 RO Lopată mică
 HU Profilozott ásó
 ES Zapa perfilada



DY



No.	Handle type / Typ trzonka	
35833	DY	200

EN Sand shovel
 PL Łopata piaskowa
 DE Sandschaufel
 RU Лопата для песка
 CS Lopata na písek
 RO Lopată pt. nisip
 HU Homoklapát
 ES Pala para arena



HRC 45 DY



No.	Handle type / Typ trzonka	
35722	DY	120

EN Sand and gravel shovel
 PL Łopata piaskowo-żwirowa
 DE Sand- und Kiesschaufel
 RU Лопата для песка и гравия
 CS Lopata na písek a štěrky
 RO Lopata pt. nisip si pietris
 HU Homok-kavics lapát
 ES Pala para arena y gravilla



DY



No.	Handle type / Typ trzonka	
35861	DY	120

EN Sharp spade
 PL Szpadel ostry
 DE Scharfer Spaten
 RU Острая лопата
 CS Ryč špičatý
 RO Hârleț ascuțit
 HU Hegyes ásó
 ES Pala de jardín puntiaguda



120 cm FIBERGLASS WŁOKNO SZKLANE DY



No.	Handle type / Typ trzonka	
35837	DY	6

EN Sand shovel
 PL Łopata piaskowa
 DE Sandschaufel
 RU Лопата для песка
 CS Lopata na písek
 RO Lopată pt. nisip
 HU Homoklapát
 ES Pala para arena



DY



No.	Handle type / Typ trzonka	
35843	DY	120

EN Sand shovel
 PL Łopata piaskowa
 DE Sandschaufel
 RU Лопата для песка
 CS Lopata na písek
 RO Lopată pt. nisip
 HU Homoklapát
 ES Pala para arena



120 cm FIBERGLASS WŁOKNO SZKLANE DY



No.	Handle type / Typ trzonka	
35835	DY	6

EN Gardening shovel
 PL Łopata kanadyjska
 DE Kanadischer Spaten
 RU Канадская лопата
 CS Kanadská lopata
 RO Hârleț gradina
 HU Kanadai lapát
 ES Pala canadiense



DY



No.	Handle type / Typ trzonka	
35855	DY	140

EN Coal shovel
 PL Łopata węglowa
 DE Kohlschaufel
 RU Лопата для угля
 CS Lopata na uhlí
 RO Lopata pt. carbune
 HU Szénlapát
 ES Pala para carbón



No.	Handle type / Typ trzonka	
35863	DY	120

EN Rake
 PL Grabie
 DE Rechen
 RU Грабли
 CS Hrábě
 RO Greblă
 HU Gereblye
 ES Rastrillo



No.	Number of teeth / Liczba zębów	Handle type / Typ trzonka	
35756	10	P	250
35757	12	P	250
35758	14	P	250
35759	16	P	250

EN Hand cultivator with handle
 PL Kultywator ręczny oprawiony
 DE Handkultivator, eingefasst
 RU Культиватор ручной садовый
 CS Ruční kultivátor s násadou
 RO Cultivator cu maner
 HU Kézi kultivátor, nyeles
 ES Cultivador manual enmascado



No.	Handle type / Typ trzonka	
35701	P	250

EN Spring rake
 PL Grabie wachlarzowe
 DE Laubrechen
 RU Грабли веерные
 CS Hrábě na listí
 RO Greblă evantai
 HU Lombseprű
 ES Rastrillo para hojas



No.	Working width / Szerokość robocza [mm]	Number of teeth / Liczba zębów	
35799	400	21	250

EN Digging fork
 PL Widły
 DE Grabegabel
 RU Вилы
 CS Zahradnické vidlice
 RO Furcă pt. grădinarit
 HU Vasvilla
 ES Horca



No.	Handle type / Typ trzonka	
35817	DY	200

EN Garden hoe
 PL Motyka
 DE Garten Handhacke
 RU Тяпка
 CS Motyčka
 RO Sapaliga
 HU Kerti kapa
 ES Azadilla



No.	Working width / Szerokość robocza [mm]	Handle type / Typ trzonka	
35761	120	P	500
35762	140	P	500

EN Cultivator
 PL Pazurki
 DE Grubber
 RU Рыхлитель
 CS Kultivátor
 RO Cultivator
 HU Kultivátor
 ES Escarificador



No.	Handle type / Typ trzonka	
35705	P	250

EN Adjustable leaf rake
 PL Grabie wachlarzowe regulowane
 DE Verstellbarer Laubrechen
 RU Регулируемые веерные грабли
 CS Hrábě na listí nastavitelné
 RO Greblă evantai reglabilă
 HU Állítható kerti lombseprű
 ES Rastrillo para hojas ajustable



No.	Working width / Szerokość robocza [mm]	Number of teeth / Liczba zębów	
35797	255-580	20	5

EN Gimlet for the soil
 PL Świdler ręczny do gleby
 DE Handbohrer für den Erdboden
 RU Ручной почвенный бур
 CS Ruční vrták do půdy
 RO Sfredel manual pt. pământ
 HU Kézi talajfúró
 ES Taladro manual para suelo



No.	Working diameter / Średnica robocza [mm]	
35670	170	50
35671	250	24

EN Long handle steel edger
 PL Nóż do dami
 DE Rasenkantenstecher
 RU Полулунный нож для обрезки краев дерна
 CS Nůz na okraje trávníku
 RO Taietor de borduri
 HU Gyepgondozás
 ES Cortador de bordes para césped



No.	Working width / Szerokość robocza [mm]	Handle type / Typ trzonka	
35680	200	T	250

EN Flat spade
 PL Szpadel prosty
 DE Rodespaten
 RU Застып
 CS Rýč rovný
 RO Hârleț cu coadă
 HU Egyenes ásó
 ES Pala de jardín recta



No.	Handle type / Typ trzonka	
35800	T	140

EN Flat spade
 PL Szpadel prosty
 DE Rodespaten
 RU Застып
 CS Rýč rovný
 RO Hârleț cu coadă
 HU Egyenes ásó
 ES Pala de jardín recta



No.	Handle type / Typ trzonka	
35801	T	200

EN Manual cultivator
 PL Kultywator ręczny
 DE Handgrubber
 RU Ручной культиватор
 CS Ruční kultivátor
 RO Cultivator manual
 HU Kézi kultivátor
 ES Cultivador manual



No.	Working width / Szerokość robocza [mm]	
35677	500	12

EN Cut lawn edger
 PL Obcinarka do krawędzi trawnika
 DE Kantenschneider
 RU Инструмент для обрезки края газона
 CS Rezačka okrajů trávníku
 RO Taietor marginii de gazon de grădină
 HU Gyepszegélyvágó
 ES Cortadora de bordes de césped

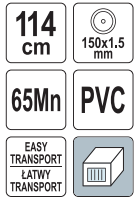

No.	Working part diameter / Średnica części roboczej [mm]	
35685	150	1

EN Flat spade
 PL Szpadel prosty
 DE Rodespaten
 RU Застып
 CS Rýč rovný
 RO Hârleț cu coadă
 HU Egyenes ásó
 ES Pala de jardín recta



No.	Handle type / Typ trzonka	
35802	T	140

EN Flat spade
 PL Szpadel prosty
 DE Rodespaten
 RU Застып
 CS Rýč rovný
 RO Hârleț cu coadă
 HU Egyenes ásó
 ES Pala de jardín recta



No.	Handle type / Typ trzonka	
35803	DY	140

EN Flat spade
 PL Szpadel prosty
 DE Rodespaten
 RU Заступ
 CS Ryč rovný
 RO Hârleț cu coadă
 HU Egyenes ásó
 ES Pala de jardín recta



No.	Handle type / Typ trzonka	
35805	DY	140

EN Drainage spade
 PL Szpadel drenarski
 DE Drainagespaten
 RU Дренажная лопата
 CS Drenážní ryč
 RO Cazma îngusta
 HU Drénező ásó
 ES Pala de drenaje



No.	Handle type / Typ trzonka	
35807	T	140

EN Sand shovel
 PL Łopata piaskowa
 DE Sandschaufel
 RU Лопата для песка
 CS Lopata na písek
 RO Lopată pt. nisip
 HU Homoklapát
 ES Pala para arena



No.	Handle type / Typ trzonka	
35839	DY	120

EN Shovel
 PL Łopata
 DE Schaufel
 RU Лопата
 CS Lopata
 RO Lopată pt. carbune
 HU Lápát
 ES Pala



No.	Handle type / Typ trzonka	
35846	DY	100

EN Sharp spade
 PL Szpadel ostry
 DE Scharfer Spaten
 RU Острая лопата
 CS Ryč špičatý
 RO Hârleț ascuțit
 HU Hegyes ásó
 ES Pala de jardín puntiaguda



No.	Handle type / Typ trzonka	
35806	DY	140

EN Drainage spade
 PL Szpadel drenarski
 DE Drainagespaten
 RU Дренажная лопата
 CS Drenážní ryč
 RO Cazma îngusta
 HU Drénező ásó
 ES Pala de drenaje



No.	Handle type / Typ trzonka	
35808	DY	140

EN Sand shovel
 PL Łopata piaskowa
 DE Sandschaufel
 RU Лопата для песка
 CS Lopata na písek
 RO Lopată pt. nisip
 HU Homoklapát
 ES Pala para arena



No.	Handle type / Typ trzonka	
35840	T	200

EN Coal shovel
 PL Łopata węglowa
 DE Kohlenschaufel
 RU Лопата для угля
 CS Lopata na uhlí
 RO Lopată pt. carbune
 HU Szénlapát
 ES Pala para carbón



No.	Handle type / Typ trzonka	
35850	T	120

EN Coal shovel
 PL Łopata węglowa
 DE Kohlschaufel
 RU Лопата для угля
 CS Lopata na uhlí
 RO Lopata pt. carbune
 HU Szénlapát
 ES Pala para carbón



No.	Handle type / Typ trzonka	
35860	DY	90

EN Sand shovel
 PL Łopata piaskowa
 DE Sandschaufel
 RU Лопата для песка
 CS Lopata na písek
 RO Lopată pt. nisip
 HU Homoklapát
 ES Pala para arena



No.	L [cm]	Handle type / Typ trzonka	
35842	135	P	100

EN Digging fork
 PL Widły
 DE Grabegabel
 RU Вилы свеколовичные кованые
 CS Zahradnické vidlice
 RO Furcă pt. grădinărit
 HU Vasvilla
 ES Horca



No.	Number of teeth / Liczba zębów	Handle type / Typ trzonka	
35815	3	P	100
35816	4	P	200

EN Digging fork
 PL Widły
 DE Grabegabel
 RU Вилы
 CS Zahradnické vidlice
 RO Furcă pt. grădinărit
 HU Vasvilla
 ES Horca



No.	Number of teeth / Liczba zębów	Handle type / Typ trzonka	
35813	4	DY	140

EN Digging fork
 PL Widły
 DE Grabegabel
 RU Вилы
 CS Zahradnické vidlice
 RO Furcă pt. grădinărit
 HU Vasvilla
 ES Horca



No.	Number of teeth / Liczba zębów	Handle type / Typ trzonka	
35890	4	DY	6

EN Digging fork
 PL Widły
 DE Grabegabel
 RU Вилы
 CS Zahradnické vidlice
 RO Furcă pt. grădinărit
 HU Vasvilla
 ES Horca



No.	Number of teeth / Liczba zębów	Handle type / Typ trzonka	
35865	4	DY	140

EN Digging fork
 PL Widły
 DE Grabegabel
 RU Вилы
 CS Zahradnické vidlice
 RO Furcă pt. grădinărit
 HU Vasvilla
 ES Horca



No.	Number of teeth / Liczba zębów	Handle type / Typ trzonka	
35864	4	DY	140

EN Household forks
 PL Widły gospodarcze
 DE Mistgabel
 RU Вилы хозяйственные
 CS Hospodářské vidle
 RO Furca
 HU Szénvilla
 ES Horquilla



No.	Number of teeth / Liczba zębów	Handle type / Typ trzonka	
35891	4	DY	6

EN Digging fork
 PL Widły
 DE Grabegabel
 RU Вилы
 CS Zahradnické vidlice
 RO Furcă pt. grădinărit
 HU Vasvilla
 ES Horca



120 cm
 FIBERGLASS
 WŁÓKNO
 SZKLANE
 DY



No.	Number of teeth / Liczba zębów	Handle type / Typ trzonka	
35892	4	DY	6

EN Cultivator
 PL Pazaruki
 DE Grubber
 RU Рыхлитель

CS Kultivátor
 RO Cultivator
 HU Kultivátor
 ES Escarifi cador

125 cm
 P



No.	Handle type / Typ trzonka	
35763	P	5

EN Rake
 PL Grabie
 DE Rechen
 RU Грабли
 CS Hrabě
 RO Greblă
 HU Gereblye
 ES Rastrillo

150 cm



No.	L [cm]	Number of teeth / Liczba zębów	
35779	150	12	150
35780	150	16	155

EN Spring rake
 PL Grabie wachlarzowe
 DE Laubrechen
 RU Грабли веерные
 CS Hrabě na listí
 RO Greblă evantai
 HU Lombseprű
 ES Rastrillo para hojas

390 mm



No.	Working width / Szerokość robocza [mm]	Number of teeth / Liczba zębów	
35798	390	21	58

EN Weed puller
 PL Wyrrywacz chwastów
 DE Unkrautfener
 RU Приспособление для вырывания сорняков
 CS Vytrhávač plevelu
 RO Dispozitiv de scos buruieni
 HU Gyomkihúzó
 ES Extractor de maleza

19 mm
 98x21.5 cm
 ABS



No.	Working width / Szerokość robocza [mm]	
35673	215	12

EN Rake
 PL Grabie
 DE Rechen
 RU Грабли

CS Hrabě
 RO Greblă
 HU Gereblye
 ES Rastrillo

P



No.	Number of teeth / Liczba zębów	Handle type / Typ trzonka	
35740	6	P	10
35741	8	P	10
35781	10	P	10
35782	12	P	10
35783	16	P	10
35784	14	P	10

EN Spring rake
 PL Grabie wachlarzowe
 DE Laubrechen
 RU Грабли веерные

CS Hrabě na listí
 RO Greblă evantai
 HU Lombseprű
 ES Rastrillo para hojas



No.	Working width / Szerokość robocza [mm]	L [cm]	Number of teeth / Liczba zębów	
35785	435	145	23	12

EN Spring rake
 PL Grabie wachlarzowe
 DE Laubrechen
 RU Грабли веерные
 CS Hrábě na listí
 RO Greblă evantai
 HU Lombseprő
 ES Rastrillo para hojas

530 mm



No.	Working width / Szerokość robocza [mm]	
99400	530	24

EN Hoe and cultivator
 PL Spulchniacz z motyczką
 DE Doppelhacke mit 2 Zinken
 RU Рыхлитель с motыгой
 CS Kultivátor s motykou
 RO Cultivator cu sapaliga
 HU Kerti villás kapa
 ES Cultivador con azada

P



No.	Handle type / Typ trzonka	
35792	P	5

EN Garden hoe
 PL Motyka
 DE Garten Handhacke
 RU Тяпка
 CS Motyčka
 RO Sapaliga
 HU Kerti kapa
 ES Azadilla

P



No.	Working width / Szerokość robocza [mm]	Handle type / Typ trzonka	
35773	120	P	5
35774	140	P	250
35776	160	P	5

EN Plastic rake
 PL Grabie plastikowe
 DE Plasteharken
 RU Грабли пластиковые
 CS Plastové hrábě
 RO Greblă de plastic
 HU Műanyag gereblye
 ES Rastrillo de plástico

X



No.	Working width / Szerokość robocza [mm]	Number of teeth / Liczba zębów	
35788	550	16	10
35789	590	18	10

EN Hoe and cultivator
 PL Motyczka z pazurkami
 DE Kleinhacke
 RU Рыхлитель комбинированный
 CS Motyčka s kultivátorem
 RO Cultivator cu sapaliga
 HU Kerti villás kapa
 ES Escarificador y azadilla

P



No.	Handle type / Typ trzonka	
35764	P	5

EN Garden hoe
 PL Motyka ogrodowa
 DE Gartenhacke
 RU Тяпка садовая
 CS Zahradní motyka
 RO Sapaliga gradina
 HU Kerti kapa
 ES Azada de jardín

P



No.	Working width / Szerokość robocza [mm]	Handle type / Typ trzonka	
35770	170	P	5

EN Garden hoe
 PL Motyka ogrodowa
 DE Gartenhacke
 RU Тяпка садовая
 CS Zahradní motyka
 RO Sapaliga gradina
 HU Kerti kapa
 ES Azada de jardín

P



No.	Working width / Szerokość robocza [mm]	Handle type / Typ trzonka	
35777	170	P	5

EN Grass cultivator
 PL Wertykulator do trawy
 DE Schneidrechen
 RU Грабли азрационные
 CS Kultivátor oboustranný
 RO Cultivator
 HU Kétoldalas talajlazító, gyephez
 ES Cultivador de dos lados

380 mm



No.	Working width / Szerokość robocza [mm]	
35700	380	5/10

EN Rake
 PL Grabie
 DE Rechen
 RU Грабли
 CS Hrábě
 RO Greblă
 HU Gereblye
 ES Rastrillo

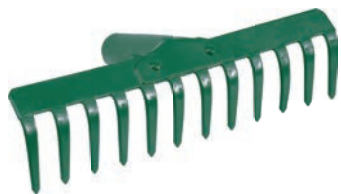

FLO

No.	Working width / Szerokość robocza [mm]	Number of teeth / Liczba zębów	
35750	270	12	48
35751	340	14	28

EN Spring rake
 PL Grabie wachlarzowe
 DE Laubrechen
 RU Грабли веерные
 CS Hrábě na listí
 RO Greblă evantai
 HU Lombseprű
 ES Rastrillo para hojas

435 mm



FLO

No.	Working width / Szerokość robocza [mm]	Number of teeth / Liczba zębów	
35786	435	23	10

EN Spring rake
 PL Grabie wachlarzowe
 DE Landschaftsbesen
 RU Грабли веерные
 CS Hráběčky
 RO Grebla de gradina
 HU Kerti gereblye
 ES Rastrillo de abanico de hojalata



FLO

No.	Working width / Szerokość robocza [mm]	Number of teeth / Liczba zębów	
35790	435	20	20
35791	580	27	20

EN Spring rake
 PL Grabie wachlarzowe
 DE Laubrechen
 RU Грабли веерные
 CS Hrábě na listí
 RO Greblă evantai
 HU Lombseprű
 ES Rastrillo para hojas

460 mm



FLO

No.	Working width / Szerokość robocza [mm]	
99391	460	50

EN Rake
 PL Grabie
 DE Rechen
 RU Грабли
 CS Hrábě
 RO Greblă
 HU Gereblye
 ES Rastrillo



FLO

No.	Working width / Szerokość robocza [mm]	Number of teeth / Liczba zębów	
35755	360	14	20

EN Spring rake
 PL Grabie wachlarzowe
 DE Laubrechen
 RU Грабли веерные
 CS Hrábě na listí
 RO Greblă evantai
 HU Lombseprű
 ES Rastrillo para hojas

460 mm



FLO

No.	Working width / Szerokość robocza [mm]	Number of teeth / Liczba zębów	
35787	460	20	10

EN Spring rake
 PL Grabie wachlarzowe
 DE Laubrechen
 RU Грабли веерные
 CS Hrábě na listí
 RO Greblă evantai
 HU Lombseprű
 ES Rastrillo para hojas

430 mm



FLO

No.	Working width / Szerokość robocza [mm]	
99390	430	40

EN Spring rake
 PL Grabie wachlarzowe
 DE Laubrechen
 RU Грабли веерные
 CS Hrábě na listí
 RO Greblă evantai
 HU Lombseprű
 ES Rastrillo para hojas

425 mm



FLO

No.	Working width / Szerokość robocza [mm]	
99401	425	60

EN Cultivator
 PL Pazurki
 DE Grubber
 RU Рыхлитель садовый
 CS Kultivátor
 RO Cultivator
 HU Kultivátor
 ES Escarificador

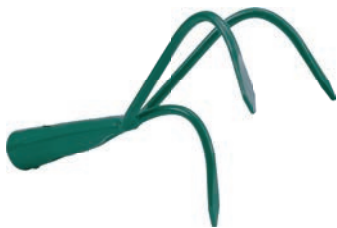

FLO

No.	Working width / Szerokość robocza [mm]	
35793	100	60
35794	130	40

EN Hoe
 PL Motyczka
 DE Garten Handhacke
 RU Мотыжка
 CS Motyčka
 RO Sapaliga
 HU Kerti kapa
 ES Azadilla



FLO

No.	Working width / Szerokość robocza [mm]	
35775	160	30

EN Hoe and cultivator
 PL Motyczka z pazurkami
 DE Kleinhacke
 RU Рыхлитель комбинированный
 CS Motyčka s kultivátorem
 RO Cultivator cu sapaliga
 HU Kerti villás kapa
 ES Escarificador y azadilla



FLO

No.	Working width / Szerokość robocza [mm]	
35795	70	60

EN Broom
 PL Miotła
 DE Strassenbesen
 RU Метла
 CS Metla
 RO Matura
 HU Partvis
 ES Cepillo pelo largo



FLO

No.	Working width / Szerokość robocza [mm]	L [mm]	
35912	360	1200	15

EN Cultivator
 PL Obsypnik
 DE Häufel
 RU Культиватор
 CS Zасыpávač
 RO Cultivator
 HU Kultivátor
 ES Arado



FLO

No.	Working width / Szerokość robocza [mm]	
35710	190	5/15

EN Hoe and cultivator
 PL Motyczka z pazurkami
 DE Kleinhacke
 RU Рыхлитель комбинированный
 CS Motyčka s kultivátorem
 RO Cultivator cu sapaliga
 HU Kerti villás kapa
 ES Escarificador y azadilla



FLO

No.	Working width / Szerokość robocza [mm]	
35760	80	60

EN Broom
 PL Miotła
 DE Strassenbesen
 RU Метла
 CS Metla
 RO Matura
 HU Partvis
 ES Cepillo pelo largo



No.	Working width / Szerokość robocza [mm]	L [mm]	
35911	250	1150	200



NYLON

EN Broom
 PL Miotła
 DE Strassenbesen
 RU Метла
 CS Metla
 RO Matura
 HU Partvis
 ES Cepillo pelo largo



No.	Working width / Szerokość robocza [mm]	
35893	300	12
35894	400	12
35895	500	12

EN Broom
 PL Miotła
 DE Strassenbesen
 RU Метла
 CS Metla
 RO Matura
 HU Partvis
 ES Cepillo pelo largo



No.	Working width / Szerokość robocza [mm]	
35899	250	12

EN Broom
 PL Miotła
 DE Strassenbesen
 RU Метла
 CS Metla
 RO Matura
 HU Partvis
 ES Cepillo pelo largo



No.	Bristle length / Długość włosia [mm]	
35905	275	12

EN Broom
 PL Miotła
 DE Strassenbesen
 RU Метла
 CS Metla
 RO Matura
 HU Partvis
 ES Cepillo pelo largo



No.	Bristle length / Długość włosia [mm]	
35906	135	12

EN Broom
 PL Miotła
 DE Strassenbesen
 RU Метла
 CS Metla
 RO Matura
 HU Partvis
 ES Cepillo pelo largo



No.	Bristle length / Długość włosia [mm]	
35908	210	8

EN Wire paving brush
 PL Szczotka do bruku z radelkiem
 DE Bürste mit Schaber für Reinigung von Pflastersteinen
 RU Щетка для тротуарной плитки с шипом
 CS Kartáč do dlažby s rádylkem
 RO Perie din sarma pt. pavaj
 HU Járdakefe pengével
 ES Cepillo para adoquines, con ruedas de trazado



No.	L [mm]	
35927	1460	10

EN Lawn mower brush
 PL Szczotka do kosiarki
 DE Rasenmäher Reinigungsbürste mit Schaber
 RU Щетка для очистки газонокосилки
 CS Kartáč na čištění sekačky
 RO Perie pt. curatat motocoase
 HU Ecset a kaszák tisztításához
 ES Cepillo limpieza



No.	Working width / Szerokość robocza [mm]	L [mm]	
35950	50	310	15

EN Barbecue cleaning brush
 PL Szczotka do grillia
 DE Grillbürste
 RU Щетка для гриля
 CS Kartáč do grilu
 RO Perie pt. curatat gratar
 HU Grillkefe
 ES Cepillo para barbacoa



No.	L [mm]	
99528	305	16

EN Sickle
PL Sierp
DE Sichel
RU Серп
CS Srp
RO Secera
HU Sarló
ES Hoz



FLO

No.	
35832	30

EN Stake for scythe
PL Klepadło do kosy
DE Dengelamboss für Sensen
RU Бабка для отбивки кос (наковальня)
CS Naklepávací kovadlinka
RO Inel de stângere pt. coasă
HU Kaszarógzító gyűrű
ES Anillo para guadanas



JUCO

No.	
35821	30

EN Wedge for scythe
PL Klin drewniany do kosy
DE Holzkeil für Sensen
RU Клин деревянный для косы
CS Klín dřevěný na kosu
RO Pană de lemn pt. coasă
HU Faék kaszához
ES Cuna de madera para guadanas



No.	
35831	12/144

EN Wooden handle
PL Trzonek uniwersalny
DE Universalstiel
RU Черенок для грабеля
CS Násada univerzální
RO Coadă din lemn
HU Univerzális nyél
ES Astil universal



No.	L [cm]	Ø [mm]	Type / Typ	
99403	100	28	P	25
99404	110	28	P	25
99402	130	28	P	25
99408	150	28	P	25

EN Forged scythe
PL Kosa kuta
DE Sensenklinge geschmiedet
RU Коса
CS Kosa kovaná
RO Lama de coasă
HU Kovácsolt kasza
ES Guadana forjada



FLO

No.	Type / Typ	
35824	No 6	25
35826	No 7	25
35828	No 8	25

EN Ring for scythe
PL Pierścień do kosy
DE Sensenring
RU Кольцо для косы
CS Kroužek na kosu
RO Inel pt. coasă
HU Kasza bilincs
ES Anillo para guadana

GALVANIZED
STEEL
STAL
OCYNKOWANA



FLO

No.	
35823	30

EN Wooden handle for scythe
PL Trzonek do kosy
DE Sensenstiel
RU Косовище деревянное
CS Násada na kosu
RO Coadă de coasă
HU Kasznyél
ES Astil para guadanas

174
cm



No.	L [cm]	
35830	174	10

EN Wooden handle for shovel
PL Trzonek do łopaty
DE Schaufelstiel gerade
RU Черенок для лопаты
CS Násada na lopatu
RO Coadă din lemn
HU Lapátnyél
ES Astil para pala

130
cm

P



No.	L [cm]	Type / Typ	
99410	130	P	10

EN Wooden handle
 PL Trzonek do grabi wachlarzowych
 DE Schaufelstiel P-Griff
 RU Черенок для лопат
 CS Násada na lopatu
 RO Coadă de lopata cu maner
 HU Lapátnyél
 ES Astil para pala

130 cm P



No.	L [cm]	Ø [mm]	Type / Typ	
99415	130	22	P	25

EN Wooden handle for broom
 PL Trzonek do miotły ulicznej
 DE Stiel für einen Straßenbesen
 RU Черенок для метлы
 CS Násada na silniční metlu
 RO Coadă matura cu filet
 HU Utcaseprű nyél
 ES Palo de escoba de calle

150 cm



No.	L [cm]			
99421	150			25

EN Broom handle with thread
 PL Trzonek do miotły z gwintem
 DE Besenstiel, holz, mit Gewinde
 RU Черенок для метлы с резьбой
 CS Násada na metlu se závitem
 RO Coadă de mătură cu filet
 HU Menetes seprűnyél
 ES Astil para escoba con rosca

120 cm P



No.	L [cm]	Type / Typ	
99418	120	P	25

EN Handle „T” for spade
 PL Trzonek do szpadla
 DE Spadelstiel T-griff
 RU Черенок для лопаты
 CS Násada na rýč
 RO Coadă din lemn
 HU Ásónyél
 ES Astil para pala

90 cm T



No.	L [cm]	Type / Typ	
99407	90	T	10

GB Wooden handle for broom
 PL Trzonek do miotły ulicznej
 DE Stiel für einen Straßenbesen
 RU Черенок для метлы
 CZ Násada na silniční metlu
 RO Coadă matura cu filet
 HU Utcaseprű nyél
 ES Palo de escoba de calle

125 cm



VOREL

No.	L [cm]		
99420	125		25

EN Broom handle with thread
 PL Trzonek do miotły z gwintem
 DE Besenstiel, holz, mit Gewinde
 RU Черенок для метлы с резьбой
 CS Násada na metlu se závitem
 RO Coadă de mătură cu filet
 HU Menetes seprűnyél
 ES Astil para escoba con rosca

120 cm P



No.	L [cm]	Ø [mm]	Type / Typ	
99416	120	22	P	25

EN Steel handle with thread
 PL Trzonek metalowy z gwintem
 DE Besenstiel, holz, mit Gewinde
 RU Черенок с резьбой
 CS Násada na metlu se závitem
 RO Coadă cu filet
 HU Menetes seprűnyél
 ES Astil para escoba con rosca

116 cm P



FLO

No.	L [cm]	Ø [mm]	
99419	118	21	24

EN Wooden handle for shovel
 PL Trzonek do łopaty
 DE Schaufelstiel gerade
 RU Черенок для лопаты
 CS Násada na lopatu
 RO Coadă din lemn
 HU Lapátnyél
 ES Astil para pala

115 cm T



No.	L [cm]	Type / Typ	
99409	115	T	10

EN Wooden handle
 PL Trzonek
 DE Schaufelstiel D-Griff
 RU Черенок для лопат
 CS Násada na lopatu
 RO Coada de lopata cu maner
 HU Lapátnyél
 ES Astil para pala



No.	L [cm]	Type / Typ	
99412	90	DY	10

EN Wooden handle for hammer-axe
 PL Trzonek do toporka
 DE Beilstiel
 RU Черенок для топора
 CS Násada na sekeru - kalač
 RO Coada de topor
 HU Ácszekerce nyél
 ES Astil para hacha con martillo



No.	L [cm]	For head / Do obucha [kg]	
99425	36	0.6	75
99426	40	0.8	25

EN Axe handle
 PL Trzonek do siekiery
 DE Axtstiel
 RU Ружьятка топора
 CS Topůrko do sekery
 RO Cap de topor
 HU Baltanyél
 ES Astil de hacha



No.	L [cm]	For head / Do obucha [kg]	
99427	50	1.0	25
99428	60	1-1.25	25
99429	70	1.25-1.8	25

EN Hammer handle
 PL Trzonek do młotka
 DE Hammerstiel
 RU Ружьятка молотка

CS Topůrko do kladiva
 RO Cap de ciocan
 HU Kalapácsnyél
 ES Astil de martillo

No.	L [cm]	For head / Do obucha [kg]	
99435	28	0.1-0.3	65
99436	32	0.3-0.7	65
99438	36	0.7-1.5	65
99440	40	0.8-2.0	50
99442	50	2.0-3.0	50
99443	60	3.0-4.0	25
99444	70	4.0-6.0	25
99445	80	5.0-8.0	25
99446	90	8.0-10.0	10

EN Wooden handle
 PL Trzonek
 DE Schaufelstiel D-Griff
 RU Черенок для лопат
 CS Násada na lopatu
 RO Coada de lopata cu maner
 HU Lapátnyél
 ES Astil para pala



No.	L [cm]	Type / Typ	
99413	90	DY	10

EN Handle for hammer-axe
 PL Trzonek do siekiery-młota
 DE Stiel für Hammeraxt
 RU Черенок для топора
 CS Násada na sekeru
 RO Coada din lemn
 HU Baltanyél
 ES Astil para hachuela



No.	L [cm]	For head / Do obucha [kg]	
99405	90	2.5	10
99406	90	4.0	10

EN Axe handle
 PL Trzonek do siekiery
 DE Axtstiel
 RU Ружьятка топора
 CS Topůrko do sekery
 RO Cap de topor
 HU Baltanyél
 ES Astil de hacha



No.	L [cm]	For head / Do obucha [kg]	
99430	80	1.8-2.0	25



- EN Pressure sprayer
- PL Spryskiwacz ciśnieniowy ręczny
- DE Drucksprüher
- RU Опрыскиватель ручной
- CS Ruční tlakový postřikovač
- RO Vermorel
- HU Permetező kézi
- ES Rociador de presión, de mano



No.	Tank capacity / Pojemność zbiornika [l]	
89507	1.0	20
89508	1.5	15
89509	2.0	15

- EN Pressure sprayer
- PL Opryskiwacz ciśnieniowy
- DE Rücken-Drucksprüher
- RU Опрыскиватель ручной ранцевый
- CS Ruční tlakový postřikovač
- RO Pulverizator de mana
- HU Permetező kézi
- ES Rociador de presión



No.	Tank capacity / Pojemność zbiornika [l]	
89520	8	6

- EN Battery sprayer
- PL Opryskiwacz akumulatorowy
- DE Akku-Sprüngerät
- RU Аккумуляторный опрыскиватель
- CS Bateriový postřikovač
- RO Vermorel cu acumulator
- HU Akkumulátoros permetező
- ES Pulverizador a batería



No.	Voltage / Napięcie [V d.c.]	Tank capacity / Pojemność zbiornika [l]	
89610	12	16	1

- EN Pressure sprayer
- PL Opryskiwacz ciśnieniowy
- DE Drucksprüher
- RU Опрыскиватель ручной
- CS Ruční tlakový postřikovač
- RO Pulverizator de mana
- HU Permetező kézi
- ES Rociador de presión

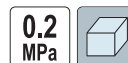

No.	Tank capacity / Pojemność zbiornika [l]	
89515	5	6
89518	8	6

- EN Pressure sprayer
- PL Opryskiwacz ciśnieniowy plecakowy
- DE Rücken-Drucksprüher
- RU Опрыскиватель ручной ранцевый
- CS Tlakový postřikovač zádoový
- RO Pulverizator portabil
- HU Permetező hát
- ES Rociador de presión tipo „mochila”

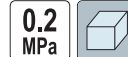

No.	Tank capacity / Pojemność zbiornika [l]	
89526	15	1
89528	20	1



- EN Battery sprayer
- PL Opryskiwacz akumulatorowy
- DE Akku-Sprühgerät
- RU Аккумуляторный опрыскиватель
- CS Bateriový postřikovač
- RO Vermorel cu acumulator
- HU Akkumulátoros permetező
- ES Pulverizador a batería



12 V	0.15-0.4 MPa
3.1 l/min	16 L
8.0 Ah	PE
SS STAINLESS STEEL STAL NERDZEWA	

- EN Pump for pressure sprayer
- PL Pompka do spryskiwacza
- DE Druckpumpe für Drucksprüher
- RU Насос на опрыскиватели
- CS Pumpa do postřikovače
- RO Pompa pt. vermores
- HU Szivattyú esőztetőhöz
- ES Bomba para el rociador



No.	For / Dla	
89536	89515, 89518, 89520	60

- EN Straight nozzle for pressure sprayer
- PL Końcówka rozpylająca do spryskiwacza
- DE Sprühdüse für Drucksprüher
- RU Распылитель на опрыскиватели
- CS Rozprašovací koncovka k postřikovači
- RO Doza pt. vermores
- HU Porlasztó tömlővég esőztetőhöz
- ES Puna de atomización para rociador



No.	For / Dla	
89537	89515, 89518, 89520	300

- EN Shower spray gun
- PL Pistolet do opryskiwacza
- DE Spritzpistole
- RU Пистолет для опрыскиватели
- CS Rozprašovací pistole na vodu
- RO Pistol pt. stropit
- HU Locsoló pisztoly
- ES Pistola de pulverización ajustable



No.	
89539	200

- EN Spray nozzle set
- PL Zestaw końcówek rozpylających
- DE Spritzdüsenatz
- RU Форсунки сменные для опрыскивателей
- CS Sada rozprašovacích koncovek
- RO Set racorduri vermores
- HU Porlasztó tömlővég készlet
- ES Juego de boquillas rociadores



No.	
89538	100

- EN Shower spray gun
- PL Pistolet do opryskiwacza
- DE Spritzpistole
- RU Пистолет для опрыскиватели
- CS Rozprašovací pistole na vodu
- RO Pistol pt. stropit
- HU Locsoló pisztoly
- ES Pistola de pulverización ajustable



No.	
89540	200

- EN Fibreglass spray lance
- PL Lanza z włókna szklanego
- DE Fibreglaslanze
- RU Трубка фиберглассовая
- CS Násadec postřikovače ze skleněného vlákna
- RO Lance din fibra de sticla
- HU Üvegyapot lándzsa
- ES Lanza de fibra de vidrio



No.	L [cm]	Ø [mm]	
89541	80	8	250

80 cm

EN Telescopic handle
 PL Lanza teleskopowa
 DE Teleskoplanze
 RU Штанга телескопическая для опрыскивателя
 CS Násadec teleskopický
 RO Maner telescopic
 HU Teleszkópos lándzsza
 ES Lanza telescópica

70-118
cm



No.	L [cm]	
89542	70-118	100

EN Set of gaskets for pressure sprayer
 PL Zestaw uszczelkek do spryskiwaczy
 DE Dichtungssatz für Drucksprüher
 RU Набор прокладок для опрыскивателя
 CS Sada těsnění k postřikovači
 RO Set de garnituri pt. vermores
 HU Tömítékészlet esőztetőhöz
 ES Juego de juntas para rociadores



No.	For / Dla	
89545	89515, 89518, 89520	500

EN Electric trimmer
 PL Podkaszarka elektryczna
 DE Elektro-Rasentrimmer
 RU Электрический триммер
 CS Elektrická sekačka
 RO Cositoare electrică
 HU Elektromos fűnyíró
 ES Segadora eléctrica

230V~
50Hz

10500
min⁻¹

80-100
cm

500
W

280
mm

2
POSITIONS
POSITIONS



24



$L_{pa} = 74,4 \pm 1,94$ dB; $L_{wa} = 94,1 \pm 1,94$ dB; $a_b = 0,794 \pm 1,5$ m/s²

No.	Power / Moc [W]	ω [min ⁻¹]	Cutting width / Szerokość cięcia [mm]	
79467	500	10500	280	4

EN 4-nozzle connector
 PL Przyłącze 4-dyszowe
 DE Querlanze mit 4 Düsen
 RU Штанга с 4 форсунками для опрыскивателей (вертикальная)

CS Připojka 4-trysková
 RO Sistem irigații
 HU 4-fűvékőcsatlakozó
 ES Conexión de cuatro surtidores

645
mm



No.	L [cm]	
89543	64.5	100

EN Set of gaskets for pressure sprayer
 PL Zestaw uszczelkek do spryskiwaczy
 DE Dichtungssatz für Drucksprüher
 RU Набор прокладок для опрыскивателя

CS Sada těsnění k postřikovači
 RO Set de garnituri pt. vermores
 HU Tömítékészlet esőztetőhöz
 ES Juego de juntas para rociadores



No.	For / Dla	
89547	89526, 89528	500

EN Cordless grass and shrub shears
 PL Akumulatorowe nożyce do trawy i krzewów
 DE Akkuschere mit Gras- und Strauchmesser
 RU Аккумуляторные ножницы для травы и кустов
 CS Akumulátorové nůžky na trávu a keře
 RO Trimmer cu acumulator pt. iarba si gard viu
 HU Főarfecele cu acumulator pt. táiat iarba
 ES Tijeras a batería para hierba y arbustos

3.6 V
1300mAh
Li-Ion

1000
min⁻¹

2in1

80
mm

110
mm



$L_{pa} = 74,6 \pm 3,0$ dB; $L_{wa} = 86,4 \pm 3,0$ dB; $a_b = 1,63 \pm 1,5$ m/s²

No.	ω [min ⁻¹]	
79500	1000	8

EN Cordless grass and shrub shears
 PL Akumulatorowe nożyce do trawy i krzewów
 DE Akkuschere mit Gras- und Strauchmesser
 RU Аккумуляторные ножницы для травы и кустов
 CS Akumulátorové nůžky na trávu a keře
 RO Trimmer cu acumulator pt. iarba si gard viu
 HU Főarfecele cu acumulator pt. táiat iarba
 ES Tijeras a batería para hierba y arbustos

3.6 V
1300mAh
Li-Ion

1000
min⁻¹

2in1

80
mm

110
mm



$L_{pa} = 74,6 \pm 3,0$ dB; $L_{wa} = 86,4 \pm 3,0$ dB; $a_b = 1,63 \pm 1,5$ m/s²

No.	ω [min ⁻¹]	
79501	1000	8

EN Hedge shears
 PL Elektryczne nożyce do żywopłotu
 DE Heckenscheren
 RU Ножницы для живой изгороди
 CS Nůžky na živý plot
 RO Foarfece pt. gard viu
 HU Sövényvágó olló
 ES Tijera para vallado



$L_{pa} = 81,6 \pm 3,0$ dB; $L_{wa} = 101,6 \pm 3,0$ dB; $a_n = 5,328 \pm 1,5 / 6,1214 \pm 1,5$ m/s²

No.	Power / Moc [W]	Cutting speed / Prędkość cięcia [min ⁻¹]	Cutting length / Długość cięcia [mm]	
79442	450	1700	410	4

EN Electrical chainsaw
 PL Elektryczna piła łańcuchowa
 DE Elektrische Kettensäge
 RU Цепная электропила
 CS Elektrická řetězová pila
 RO Ferăstrau electric cu lanț
 HU Elektromos láncfűrész
 ES Sierra de cadena eléctrica

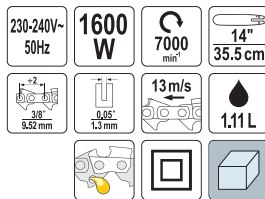

$L_{pa} = 90,2 \pm 3,0$ dB; $L_{wa} = 103,2 \pm 3,0$ dB; $a_n = 8,393 \pm 1,5 / 6,002 \pm 1,5$ m/s²

No.	Power / Moc [W]	
79675	1600	2

EN Chain saw file
 PL Pilnik okrągły do łańcuchów
 DE Runde Kettenfeile
 RU Цилиндрический напильник для цепей
 CS Kulatý pilník na řetězy
 RO Pila rotundă pt. lanțuri
 HU Láncvágó körtűrészt
 ES Lima redonda para cadenas



No.	L [mm]	Chain pitch / Podziałka łańcucha	Ø [mm]	pcs / szt.	
79861	200	3/8 piccolo	4.0	3	4/200
79862	200	microlite	4.5	3	4/200
79863	200	.325	4.8	3	4/200

EN Universal wrench for gasoline machines
 PL Klucz uniwersalny do narzędzi spalinowych
 DE Universalschlüssel für Benzin Maschinen
 RU Универсальный ключ для бензинового инструмента

CS Univerzální klíč pro benzínové stroje
 RO Cheie universală pt. mașini pe benzină
 HU Kulccsal benzín eszköz
 ES Llave universal para máquinas de gasolina



No.	
79869	10/100

EN Hedge shears
 PL Elektryczne nożyce do żywopłotu
 DE Heckenscheren
 RU Ножницы для живой изгороди
 CS Nůžky na živý plot
 RO Foarfece pt. gard viu
 HU Sövényvágó olló
 ES Tijera para vallado



$L_{pa} = 78,58 \pm 1,489$ dB; $L_{wa} = 98,54 \pm 1,489$ dB; $a_n = 3,272 \pm 1,5 / 3,435 \pm 1,5$ m/s²

No.	Power / Moc [W]	Cutting speed / Prędkość cięcia [min ⁻¹]	Cutting length / Długość cięcia [mm]	
79448	550	1700	510	4

EN Electric soil miller
 PL Glebogryzarka elektryczna
 DE Elektro-Bodenhacke
 RU Электрический культиватор
 CS Elektrický kultivátor
 RO Motosapa electrică
 HU Elektromos kapálógép
 ES Cultivador rotativo eléctrico

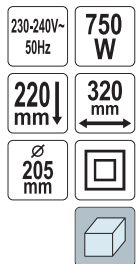

$L_{pa} = 79,0 \pm 3,0$ dB; $L_{wa} = 91,87 \pm 0,48$ dB; $a_n = 1,153 \pm 1,5 / 1,158 \pm 1,5$ m/s²

No.	Power / Moc [W]	
79725	750	1

EN Guide for chain saw file
 PL Prowadnik do pilnika do łańcuchów
 DE Führung für die Kettenfeile
 RU Направляющая для напильника для цепей
 CS Vedení pro pilník na řetězy
 RO Ghidaj pt. pila pt. lanțuri
 HU Megvezető a láncfűrészhez
 ES Guía de lima para cadenas



No.	Chain pitch / Podziałka łańcucha	Ø [mm]	
79865	3/8 piccolo	4.0	50/150
79866	microlite	4.5	50/150
79867	.325	4.8	50/150

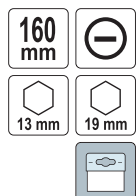

EN Line head
 PL Głowica żyłkowa
 DE Trimmerkopf
 RU Головка с леской
 CS Strunová hlava
 RO Cap cu cablu
 HU Damil fej
 ES Cabezal de hilo



FLO

No.	Ø [mm]	
79550	2.0-2.4	10/40

EN Line head
 PL Głowica żyłkowa
 DE Trimmerkopf
 RU Головка с леской
 CS Strunová hlava
 RO Cap cu cablu
 HU Damil fej
 ES Cabezal de hilo



FLO

No.	Ø [mm]	
79552	2.4-2.7	10/40

EN Grass trimmer line
 PL Żyłka tnąca
 DE Mähfaden
 RU Леска для триммера
 CS Struna do strunové sekačky
 RO Furtun gradina
 HU Damil szegélynyíró géphez
 ES Hilo de cortar

FLO

No.	Ø [mm]	L [m]	Cutting line profile / Przekrój żyłki	
89401	1.3	10	○	20/240
89402	1.6	10	○	20/240
89403	2.0	10	○	20/240
89404	2.4	10	○	12/144
89405	2.6	10	○	12/144
89406	3.0	10	○	12/144

EN Grass trimmer line
 PL Żyłka tnąca
 DE Mähfaden
 RU Леска для триммера
 CS Struna do strunové sekačky
 RO Furtun gradina
 HU Damil szegélynyíró géphez
 ES Hilo de cortar



FLO

No.	Ø [mm]	L [m]	Cutting line profile / Przekrój żyłki	
89441	2.0	120	○	27
89442	2.4	90	○	27
89443	2.6	70	○	27
89444	3.0	56	○	27

EN Line head
 PL Głowica żyłkowa
 DE Trimmerkopf
 RU Головка с леской
 CS Strunová hlava
 RO Cap cu cablu
 HU Damil fej
 ES Cabezal de hilo

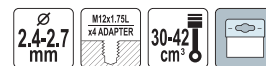

FLO

No.	Ø [mm]	
79551	2.4-2.7	10/40

EN Line head
 PL Głowica żyłkowa
 DE Trimmerkopf
 RU Головка с леской
 CS Strunová hlava
 RO Cap cu cablu
 HU Damil fej
 ES Cabezal de hilo



FLO

No.	Ø [mm]	For / Dla	
79468	1.2	79467	20/100



EN Grass trimmer line
 PL Żyłka tnąca
 DE Mähfaden
 RU Леска для триммера
 CS Struna do strunové sekačky
 RO Furtun gradina
 HU Damil szegélynyíró géphez
 ES Hilo de cortar



FLO

No.	Ø [mm]	L [m]	Cutting line profile / Przekrój żyłki	
89411	1.3	10	□	20/240
89412	1.6	10	□	20/240
89413	2.0	10	□	20/240
89414	2.4	10	□	12/144
89415	2.6	10	□	12/144
89416	3.0	10	□	12/144

EN Grass trimmer line
 PL Żyłka tnąca
 DE Mähfaden
 RU Леска для триммера
 CS Struna do střímové sekačky
 RO Furtun gradina
 HU Damil szegélynyíró géphez
 ES Hilo de cortar



No.	Ø [mm]	L [m]	Cutting line profile / Przekrój żyłki	
89452	2.4	90		16
89453	2.6	70		16
89454	3.0	56		16

EN Grass trimmer line
 PL Żyłka tnąca
 DE Mähfaden
 RU Леска для триммера
 CS Struna do střímové sekačky
 RO Furtun gradina
 HU Damil szegélynyíró géphez
 ES Hilo de cortar



No.	Ø [mm]	L [m]	Cutting line profile / Przekrój żyłki	
89456	2.0	90	☆	9/27
89457	2.4	90	☆	9/27
89458	2.6	90	☆	9/27
89459	3.0	60	☆	9/27

EN Grass trimmer line
 PL Żyłka tnąca
 DE Mähfaden
 RU Леска для триммера
 CS Struna do střímové sekačky
 RO Furtun gradina
 HU Damil szegélynyíró géphez
 ES Hilo de cortar

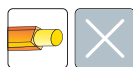

No.	Ø [mm]	L [m]	Cutting line profile / Przekrój żyłki	
89465	2.4	90		10/20
89466	2.7	70		10/20
89467	3.0	60		10/20

EN Grass trimmer line
 PL Żyłka tnąca
 DE Mähfaden
 RU Леска для триммера
 CS Struna do střímové sekačky
 RO Furtun gradina
 HU Damil szegélynyíró géphez
 ES Hilo de cortar



No.	Ø [mm]	L [m]	Cutting line profile / Przekrój żyłki	
89421	1.3	15	☆	24/288
89422	1.6	15	☆	20/240
89423	2.0	15	☆	16/192
89424	2.4	15	☆	12/144
89425	2.6	15	☆	12/144
89426	3.0	15	☆	10/120

EN Grass trimmer line
 PL Żyłka tnąca
 DE Mähfaden
 RU Леска для триммера
 CS Struna do střímové sekačky
 RO Furtun gradina
 HU Damil szegélynyíró géphez
 ES Hilo de cortar

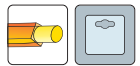

No.	Ø [mm]	L [m]	Cutting line profile / Przekrój żyłki	
89462	2.4	15		10/120
89463	2.7	15		10/120
89464	3.0	12		10/120

EN Grass trimmer line
 PL Żyłka tnąca
 DE Mähfaden
 RU Леска для триммера
 CS Struna do střímové sekačky
 RO Furtun gradina
 HU Damil szegélynyíró géphez
 ES Hilo de cortar

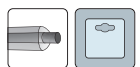

No.	Ø [mm]	L [m]	Cutting line profile / Przekrój żyłki	
89470	2.4	15		10/120
89471	2.7	15		10/120
89472	3.0	12		10/120

EN Grass trimmer line
 PL Żyłka tnąca
 DE Mähfaden
 RU Леска для триммера
 CS Struna do strunové sekačky
 RO Furtun gradina
 HU Damil szegélynyíró géphez
 ES Hilo de cortar

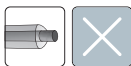

No.	Ø [mm]	L [m]	Cutting line profile / Przekrój żyłki	
89473	2.4	90		10/20
89474	2.7	70		10/20
89475	3.0	60		10/20

EN Grass trimmer line
 PL Żyłka tnąca
 DE Mähfaden
 RU Леска для триммера
 CS Struna do strunové sekačky
 RO Furtun gradina
 HU Damil szegélynyíró géphez
 ES Hilo de cortar



No.	Ø [mm]	L [m]	Cutting line profile / Przekrój żyłki	
89483	2.0	90		10/20
89484	2.4	90		10/20
89485	2.7	70		10/20
89486	3.0	60		10/20

EN Working gloves
 PL Rękawice robocze
 DE Arbeitshandschuhe
 RU Рабочие перчатки
 CS Pracovní rukavice
 RO Mănuși
 HU Védőkesztyű
 ES Guantes de piel



No.	Size / Rozmiar	
74100	10	12/300

EN Working gloves
 PL Rękawice robocze
 DE Arbeitshandschuh
 RU Перчатки
 CS Pracovní rukavice
 RO Mănuși
 HU Védőkesztyű
 ES Guantes



No.	Size / Rozmiar	
74126	8	12/300
74132	9	12/300

EN Grass trimmer line
 PL Żyłka tnąca
 DE Mähfaden
 RU Леска для триммера
 CS Struna do strunové sekačky
 RO Furtun gradina
 HU Damil szegélynyíró géphez
 ES Hilo de cortar



No.	Ø [mm]	L [m]	Cutting line profile / Przekrój żyłki	
89478	1.6	15		20/240
89479	2.0	15		20/240
89480	2.4	15		10/120
89481	2.7	15		10/120
89482	3.0	12		10/120



EN Working gloves
 PL Rękawice robocze
 DE Arbeitshandschuh
 RU Перчатки
 CS Pracovní rukavice
 RO Mănuși
 HU Védőkesztyű
 ES Guantes



No.	Size / Rozmiar	
74125	8	12/300
74130	9	12/300
74131	10	12/300

EN Working gloves
 PL Rękawice robocze
 DE Arbeitshandschuh
 RU Перчатки
 CS Pracovní rukavice
 RO Mănuși
 HU Védőkesztyű
 ES Guantes



No.	Size / Rozmiar	
74127	8	12/300
74134	9	12/300
74135	10	12/300

EN Working gloves
 PL Rękawice robocze
 DE Arbeitshandschuh
 RU Перчатки
 CS Pracovní rukavice
 RO Mănuși
 HU Védőkesztyű
 ES Guantes



No.	Size / Rozmiar	
74128	8	12/300
74136	9	12/300
74137	10	12/300

EN Gardening gloves
 PL Rękawice ogrodnicze
 DE Arbeitshandschuh
 RU Перчатки
 CS Pracovní rukavice
 RO Mănuși
 HU Védőkesztyű
 ES Guantes



No.	Size / Rozmiar	
74121	8	50/1000

EN Gardening gloves
 PL Rękawice ogrodnicze
 DE Arbeitshandschuh
 RU Перчатки
 CS Pracovní rukavice
 RO Mănuși
 HU Védőkesztyű
 ES Guantes



No.	Size / Rozmiar	
74113	8	50/1000

EN Women's rain boots
 PL Kalosze damskie
 DE Damen - Gummistiefel
 RU Галоши женские
 CS Dámské galoše
 RO Cizme damă
 HU Női gumicsizma
 ES Chanclos para mujer



No.	Size / Rozmiar	
73931	36	7
73932	37	7
73933	38	7
73934	39	7
73935	40	7
73936	41	7

EN Gardening gloves
 PL Rękawice ogrodnicze
 DE Arbeitshandschuh
 RU Перчатки
 CS Pracovní rukavice
 RO Mănuși
 HU Védőkesztyű
 ES Guantes



No.	Size / Rozmiar	
74117	8	50/1000

EN Gardening gloves
 PL Rękawice ogrodnicze
 DE Arbeitshandschuh
 RU Перчатки
 CS Pracovní rukavice
 RO Mănuși
 HU Védőkesztyű
 ES Guantes



No.	Size / Rozmiar	
74123	8	50/1000

EN Gardening gloves
 PL Rękawice ogrodnicze
 DE Arbeitshandschuh
 RU Перчатки
 CS Pracovní rukavice
 RO Mănuși
 HU Védőkesztyű
 ES Guantes



No.	Size / Rozmiar	
74115	8	50/1000



EN Men's rain boots
 PL Kalosze męskie
 DE Herren - Gummistiefel
 RU Галоши мужские
 CS Pánské galoše
 RO Cizme bărbaj
 HU Férfi gumicsizma
 ES Chanclos para hombre



VOREL

No.	Size / Rozmiar	
73937	41	5
73938	42	5
73939	43	5
73940	44	5
73941	45	5
73942	46	5
73943	47	5

EN Men's rain boots
 PL Kalosze męskie
 DE Herren - Gummistiefel
 RU Галоши мужские
 CS Pánské galoše
 RO Cizme bărbaj
 HU Férfi gumicsizma
 ES Chanclos para hombre



VOREL

No.	Size / Rozmiar	
73950	41	5
73951	42	5
73952	43	5
73953	44	5
73954	45	5
73955	46	5

EN Men's rain boots
 PL Kalosze męskie
 DE Herren - Gummistiefel
 RU Галоши мужские
 CS Pánské galoše
 RO Cizme bărbaj
 HU Férfi gumicsizma
 ES Chanclos para hombre



VOREL

No.	Size / Rozmiar	
73966	40	5
73967	41	5
73968	42	5
73969	43	5
73970	44	5
73971	45	5
73972	46	5
73973	47	5

EN Women's rain boots
 PL Kalosze damskie
 DE Damen - Gummistiefel
 RU Галоши женские
 CS Dámské galoše
 RO Cizme damă
 HU Női gumicsizma
 ES Chanclos para mujer



VOREL

No.	Size / Rozmiar	
73945	37	5
73946	38	5
73947	39	5

EN Felt PVC boots
 PL Buty gumowo-filcowe
 DE Gummistiefel mit Filtz
 RU Сапоги резиновые с войлоком
 CS Holinky s filcem
 RO Cizme PVC
 HU Gumi - filc csizma
 ES Botas de goma fieltro

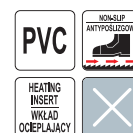

VOREL

No.	Size / Rozmiar	
73958	40	5
73959	41	5
73960	42	5
73961	43	5
73962	44	5
73963	45	5
73964	46	5

EN All purpose boot tray
 PL Wielofunkcyjna podstawa gospodarcza
 DE Garten- und Haushalt-Unterlage
 RU Многофункциональный поднос

CS Multifunkční podložka
 RO Tava multifunctionala
 HU Többfunkciós tálcá
 ES Bandeja de arranque universal

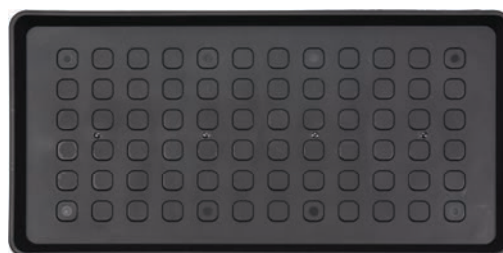

VOREL

No.	[mm]	
67260	780x384x32	30

EN Knee pads
 PL Nakolanniki
 DE KnieSchützer
 RU Наколенники
 CS Chrániče kolen
 RO Genunchiere
 HU Térdvédő
 ES Rodilleras

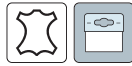

No.

74600



50

EN Knee pads
 PL Nakolanniki
 DE KnieSchützer
 RU Наколенники
 CS Chrániče kolen
 RO Genunchiere
 HU Térdvédő
 ES Rodilleras



No.

74622



50

EN Knee pads
 PL Nakolanniki
 DE KnieSchützer
 RU Наколенники
 CS Chrániče kolen
 RO Genunchiere
 HU Térdvédő
 ES Rodilleras



No.

74601



24

EN Knee pads
 PL Nakolanniki
 DE KnieSchützer
 RU Наколенники
 CS Chrániče kolen
 RO Genunchiere
 HU Térdvédő
 ES Rodilleras



No.

74603



6/24

EN Knee pads
 PL Nakolanniki
 DE KnieSchützer
 RU Наколенники
 CS Chrániče kolen
 RO Genunchiere
 HU Térdvédő
 ES Rodilleras

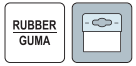

No.

74610



20

EN Knee pads
 PL Nakolanniki
 DE KnieSchützer
 RU Наколенники
 CS Chrániče kolen
 RO Genunchiere
 HU Térdvédő
 ES Rodilleras



No.

74624



12/24

EN Knee pads
 PL Nakolanniki
 DE KnieSchützer
 RU Наколенники
 CS Chrániče kolen
 RO Genunchiere
 HU Térdvédő
 ES Rodilleras



No.

74602



6/36

EN Knee pads
 PL Nakolanniki
 DE KnieSchützer
 RU Наколенники
 CS Chrániče kolen
 RO Genunchiere
 HU Térdvédő
 ES Rodilleras



No.

74604



20

EN Knee pads
 PL Nakolanniki - wkładki
 DE Knieschützer
 RU Наколенники
 CS Chrániče kolien
 RO Genunchiere
 HU Térdvédő
 ES Rodilleras

210x165
 x18
 mm

EVA

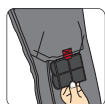

VOREL

No.	60
74595	60

EN Safety helmet
 PL Kask ochronny
 DE Schutzhelm
 RU Каска защитная
 CS Ochranná přilba
 RO Cască de protecție
 HU Védősisak
 ES Casco de protección

ABS



VOREL

No.	Color / Kolor	40
74190	biały	40
74191	czerwony	40
74192	niebieski	40
74193	żółty	40
74194	pomarańczowy	40
74195	zielony	40

EN Face shield
 PL Osłona siatkowa twarzy z nagłowiek
 DE Gesichtsschutz mit Maschenvisier
 RU Сетчатая защитная маска с обвязкой для головы
 CS Síťová ochrana tváře s postrojem
 RO Vizor protecție față
 HU Hálós arcvédő
 ES Pantalla con visor de malla metálica

PE

STEEL
 STAL



VOREL

No.	25
74468	25

EN Safety helmet
 PL Kask ochronny
 DE Schutzhelm
 RU Каска защитная
 CS Ochranná přilba
 RO Cască de protecție
 HU Védősisak
 ES Casco de protección

HDPE



VOREL

No.	Color / Kolor	30
74171	pomarańczowy	30
74172	żółty	30
74173	biały	30
74174	czerwony	30
74175	niebieski	30
74176	zielony	30

EN Face shield with PC visor
 PL Przyłbica z osłoną wymienną
 DE Schweisserschutzhelm mit austauschbarer Abdeckung
 RU Шлем с заменяемой защитой
 CS Štít s vyměnitelným krytem
 RO Vizieră cu protecție schimbabilă
 HU Arcvédő cserélhető pajzsral
 ES Antifaz con protección reemplazable

395x200
 mm

1
 OPTICAL CLASS
 KLASA OPTYCZNA

PE

PVC



VOREL

No.	25
74471	25

EN Face shield with steel mesh and ear muff
 PL Przyłbica z osłoną wymienną i nausznikami przeciwhałasowymi
 DE Schweisserschutzhelm mit austauschbarer Abdeckung und Ohrenschützer gegen Lärm
 RU Шлем с заменяемой защитой и наушниками против шума
 CS Štít s vyměnitelným krytem a chrániči proti hluku
 RO Vizieră cu protecție schimbabilă și căști de protecție antigomot
 HU Arcvédő cserélhető pajzsral és fülvédő kagylóval
 ES Antifaz con protección reemplazable y protectores de oídos

395x200
 mm



VOREL

No.	40
74462	40

FLO

EN Hearing protectors
 PL Nauszniki przeciwhałasowe
 DE Gehörschutz
 RU Средства защиты слуха
 CS Chrániče sluchu
 RO Antifoane
 HU Fültok
 ES Protectores auditivos



SNR
24dB



No.		
74580		60

EN Safety glasses
 PL Okulary ochronne
 DE Schutzbrille
 RU Очки защитные открытые
 CS Ochranné brýle
 RO Ochelari pt. protectie
 HU Védőszemüveg
 ES Gafas protectoras



1
OPTICAL CLASS
KLASA OPTYCZNA

PC



No.	Type / Typ	
74501	TVS	8/80

EN Safety glasses
 PL Okulary ochronne
 DE Schutzbrille
 RU Очки защитные открытые
 CS Ochranné brýle
 RO Ochelari pt. protectie
 HU Védőszemüveg
 ES Gafas protectoras



1
OPTICAL CLASS
KLASA OPTYCZNA

PC



No.	Type / Typ	
74503	DY-8525	12/240

EN Safety glasses
 PL Okulary ochronne
 DE Schutzbrille
 RU Очки защитные открытые
 CS Ochranné brýle
 RO Ochelari pt. protectie
 HU Védőszemüveg
 ES Gafas protectoras



1
OPTICAL CLASS
KLASA OPTYCZNA

PC



No.	Type / Typ	
74508	HF-103	10/120

EN Hearing protectors
 PL Nauszniki przeciwhałasowe
 DE Gehörschutz
 RU Средства защиты слуха
 CS Chrániče sluchu
 RO Antifoane
 HU Fültok
 ES Protectores auditivos



SNR
20.4dB



No.		
74581		10/60

EN Safety glasses
 PL Okulary ochronne
 DE Schutzbrille
 RU Очки защитные открытые
 CS Ochranné brýle
 RO Ochelari pt. protectie
 HU Védőszemüveg
 ES Gafas protectoras



1
OPTICAL CLASS
KLASA OPTYCZNA

PC



No.	Type / Typ	
74505	STD SG-007	12/240

EN Safety glasses
 PL Okulary ochronne
 DE Schutzbrille
 RU Очки защитные открытые
 CS Ochranné brýle
 RO Ochelari pt. protectie
 HU Védőszemüveg
 ES Gafas protectoras



1
OPTICAL CLASS
KLASA OPTYCZNA

PC



No.	Type / Typ	
74504	DY-8526	15/150

EN Safety glasses
 PL Okulary ochronne
 DE Schutzbrille
 RU Очки защитные открытые
 CS Ochranné brýle
 RO Ochelari pt. protectie
 HU Védőszemüveg
 ES Gafas protectoras



1
OPTICAL CLASS
KLASA OPTYCZNA

PC



No.	Type / Typ	
74509	HF-105	10/100

EN Slow release watering bag
 PL Worek nawadniający
 DE Bewässerungssack
 RU Мешок для орошения
 CS Zavlažovací pytel
 RO Punga pt. irigat
 HU Faöntöző zsák
 ES Bolsa de riego



60 L 92x98 cm
 420 GSM PVC



No.	Capacity / Pojemność [l]	
89715	60	24

EN Slow release watering bag
 PL Worek nawadniający
 DE Bewässerungssack
 RU Мешок для орошения
 CS Zavlažovací pytel
 RO Punga pt. irigat
 HU Faöntöző zsák
 ES Bolsa de riego



75 L 145 | 1000 mm
 550 GSM PVC

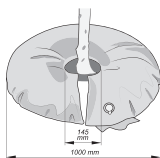

No.	Capacity / Pojemność [l]	
89722	75	20

EN Compressible rain barrel
 PL Zbiornik na wodę deszczową
 DE Regenwasserbehälter
 RU Бак для дождевой воды
 CS Nádrž na dešťovou vodu
 RO Butoi de ploaie compresibil
 HU Esővizgyűjtő tartály
 ES Depósito de agua pluvial



250 L 60x88 cm
 3/4" 19mm PVC
 PP Juv



No.	Capacity / Pojemność [l]	
89702	250	6

EN Valves set
 PL Zestaw zaworów
 DE Ventil-Set
 RU Комплект клапанов

CS Sada ventiliů
 RO Set valve
 HU Szelepkészlet
 ES Juego de válvulas



No.	Hose diameter / Średnica węża	pcs / szt.	
89081	3/4" (19.0 mm)	3	50

EN Slow release watering bag
 PL Worek nawadniający
 DE Bewässerungssack
 RU Мешок для орошения
 CS Zavlažovací pytel
 RO Punga pt. irigat
 HU Faöntöző zsák
 ES Bolsa de riego



55 L 145 | 900 mm
 550 GSM PVC

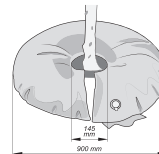

No.	Capacity / Pojemność [l]	
89720	55	20

EN Compressible rain barrel
 PL Zbiornik na wodę deszczową
 DE Regenwasserbehälter
 RU Бак для дождевой воды
 CS Nádrž na dešťovou vodu
 RO Butoi de ploaie compresibil
 HU Esővizgyűjtő tartály
 ES Depósito de agua pluvial



100 L 40x78 cm
 3/4" 19mm PVC
 PP Juv



No.	Capacity / Pojemność [l]	
89700	100	6

EN Compressible rain barrel
 PL Zbiornik na wodę deszczową
 DE Regenwasserbehälter
 RU Бак для дождевой воды
 CS Nádrž na dešťovou vodu
 RO Butoi de ploaie compresibil
 HU Esővizgyűjtő tartály
 ES Depósito de agua pluvial



500 L 80x98 cm
 3/4" 19mm PVC
 PP Juv



No.	Capacity / Pojemność [l]	
89704	500	4



3 PCS 3/4" 19mm
 PVC PP

EN Lawn edge
 PL Obrzeże trawnikowe, zielone
 DE Gartenumrandung
 RU Оградка для огорода
 CS Plastový okraj trávníku
 RO Gărduț plastic grădină
 HU Ágyásszegély
 ES Borde para jardín



FLO

No.	H [mm]	L [m]	
88700	100	9	48
88701	150	9	36
88702	200	9	24

EN Shade cloth
 PL Mata do cieniowania
 DE Schattenmatte
 RU Коврик для тонировки
 CS Podložka pro stínování
 RO Panza pt. umbra
 HU Árnyékoló háló
 ES Tela de malla sombra

1.5x10 m 90 g/m² PE



FLO

No.	Size / Rozmiar [m]	
88740	1.5x10	9

EN Twist tie with cutter
 PL Druk ogrodniczy powlekany z obcinaczem
 DE Gartendraht, beschichtet, mit Abscheider
 RU Проволока огородная с диспенсером
 CS Drát pro zahrádkáře potažený plastem s odřezávačem
 RO Sărmă pt. grădină izolată cu tăietor
 HU Galvanizált kötöződrót, darabolóval
 ES Alambre de jardinero cubierto con tronzador



FLO

No.	L [m]	
88805	30	24/144
88806	50	24/144

EN Plant binding set
 PL Zestaw ogrodniczy do podwiązania roślin
 DE Gartensatz zum Abbinden von Pflanzen
 RU Набор огородный для подвязки растений

CS Souprava pro zahrádkáře k vyvazování rostlin
 RO Set pt. grădină pt. legare plante
 HU Kertészeti szett: növények felkötéséhez
 ES Juego para jardín para sujetar plantas

71 PCS



FLO

No.	pcs / szt.	
88811	71	24

EN Lawn edge
 PL Obrzeże trawnikowe, brązowe
 DE Gartenumrandung
 RU Оградка для огорода
 CS Plastový okraj trávníku
 RO Gărduț plastic grădină
 HU Ágyásszegély
 ES Borde para jardín



FLO

No.	H [mm]	L [m]	
88703	100	9	48
88704	150	9	36
88705	200	9	24

EN Twist tie
 PL Druk ogrodniczy
 DE Gartendraht
 RU Проволока огородная

CS Drát pro zahrádkáře
 RO Sărmă pt. grădină
 HU Kötöződrót
 ES Alambre de jardinero

2 PCS 50m



FLO

No.	L [m]	
88801	50	12/48

EN Garden flexible tie
 PL Druk ogrodniczy w oslonie z pianki
 DE Gartendraht, in einer Abdeckung aus Schaumstoff
 RU Проволока огородная покрытая пенкой
 CS Drát pro zahrádkáře s pěnovým pláštěm
 RO Sărmă pt. grădină cu izolație din spumă
 HU Kötöződrót, plasztik bevonattal
 ES Alambre de jardinero en cubierta de espuma

10 mm 10m



FLO

No.	L [m]	
88809	10	40

EN Plant clips set
 PL Klipsy do mocowania roślin
 DE Clips
 RU Зажимы
 CS Klipy
 RO Set clipsuri
 HU Csatok
 ES Clips

45 PCS 3.4x3.0cm x15 3.0x2.5cm x15 2.3x2.0cm x15 PP



FLO

No.	pcs / szt.	
88812	45	24/48

EN String set
 PL Zestaw sznurków
 DE Schnursatz
 RU Набор шнуров
 CS Sada provázků
 RO Set sfori
 HU Zsinórkészlet
 ES Juego de cuerdas



No.	pcs / szt.	
88820	6	36

EN Plant antifreeze protective cover set
 PL Pokrowce przeciw zamarzaniu roślin
 DE Winterschutzsäcke für Pflanzen
 RU Чехлы для защиты от заморозания растений
 CS Kryty proti zamrznání rostlin
 RO Set protecții anti îngheț pt. plante
 HU Fagyvédő fólia növényekre
 ES Cubre plantas



No.	Size / Rozmiar [cm]	pcs / szt.	
89753	80x75	3	24

EN Vegetable growing house
 PL Miniszklarnia przydomowa
 DE Mini Garten-Gewächshaus
 RU Садовая мини-теплица
 CS Mini skleník do zahrádky
 RO Sera pt. legume
 HU Mini kerti üvegház
 ES Mini invernadero doméstico



No.	Dimensions / Wymiary [cm]	
90000	100x50x150	1

EN Vegetable growing house
 PL Miniszklarnia przydomowa
 DE Mini Garten-Gewächshaus
 RU Садовая мини-теплица
 CS Mini skleník do zahrádky
 RO Sera pt. legume
 HU Mini kerti üvegház
 ES Mini invernadero doméstico



No.	Dimensions / Wymiary [cm]	
90001	120x60x60	1

EN Frost protection fleece jacket
 PL Kaptur ochronny dla roślin
 DE Pflanzenschutzhaube
 RU Укрывной колпак для растений
 CS Ochranná kapuce na rostliny
 RO Protecție anti îngheț
 HU Védőgallér növényekre
 ES Saco protector para plantas



No.	Size / Rozmiar [cm]	
89750	120x180	24

EN Black net tunnel
 PL Czarny tunel ochrony roślin
 DE Pflanzenschutztunnel schwarz
 RU Черный туннель для защиты растений
 CS Černý tunel pro ochranu rostlin
 RO Protecție plante tip tunel
 HU Fekete védőalagút növényekre
 ES Túnel de malla negra para plantas



No.	Dimensions / Wymiary [cm]	
89770	300x45x45	12

EN 5-tier green house
 PL Miniszklarnia 5 poziomów
 DE Mini Gewächshaus 5 Regale
 RU Мини-теплица 5 уровней
 CS 5 úrovňový mini skleník
 RO Sera cu 5 rafturi
 HU Mini üvegház 5 szintes
 ES Mini invernadero 5 niveles



No.	Dimensions / Wymiary [cm]	
90002	200x69x49	1

EN Garden greenhouse
 PL Miniszklarnia naskrzyniowa
 DE Mini-Gewächshaus
 RU Мини-теплица грубоук
 CS Mini skleník podstavec
 RO Sera gradina
 HU Mini ládás üvegház
 ES Mini invernadero instalado en una base



No.	Dimensions / Wymiary [cm]	
90003	60x80x120	1

EN Walk-in greenhouse
 PL Szklarnia foliowa
 DE Foliengewächshaus
 RU Пленочная теплица
 CS Fóliový skleník
 RO Sera
 HU Fólia üvegház
 ES Invernadero de plástico



No.	Dimensions / Wymiary [cm]	
90031	143x143x195	1

EN Folding garden trash bag
 PL Kosz ogrodowy składany
 DE Klappbarer Gartenkorb
 RU Складная садовая корзина
 CS Skládací zahradní koš
 RO Cos gunoi gradina pliabil
 HU Összecsukható kerti szemetes
 ES Contenedor plegable para jardín



No.	Size / Rozmiar [mm]	
90150	880x450	12

EN Walk-in greenhouse
 PL Szklarnia foliowa
 DE Foliengewächshaus
 RU Пленочная теплица
 CS Fóliový skleník
 RO Sera
 HU Fólia üvegház
 ES Invernadero de plástico



No.	Dimensions / Wymiary [cm]	
90030	143x73x195	1

EN Soil survey instrument
 PL Miernik ogrodniczy
 DE Gartenmessgerät
 RU Измеритель огородный
 CS Zahradnický měřicí přístroj
 RO Aparat de măsurat grădinăresc
 HU Négyfunkciós, kerti mérőműszer
 ES Medidor de horticultor

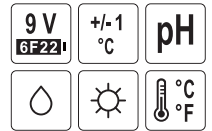

No.		
89000		10

EN Garden basket
 PL Kosz ogrodniczy
 DE Gartenkorb
 RU Корзина садовая
 CS Zahradní koš
 RO Coș de grădină
 HU Kerti kosár
 ES Cesta de jardín



No.	Capacity / Pojemność [l]	
35608	13	160

EN Garden basket
 PL Kosz ogrodniczy
 DE Gartenkorb
 RU Корзина садовая
 CS Zahradní koš
 RO Coș de grădină
 HU Kerti kosár
 ES Cesta de jardín



No.	Capacity / Pojemność [l]	
35610	25	480
35611	35	280

EN Universal grow bag
 PL Uniwersalna torba ogrodowa
 DE Mehrzweck-Gartentasche
 RU Универсальная садовая сумка
 CS Univerzální zahradní taška
 RO Geanta univerzala pt. cultivat
 HU Univerzális kertészláská
 ES Bolsa de jardín universal



No.	Size / Rozmiar [mm]	
90240	440x370	24

EN Galvanized bucket
 PL Wiadro ocynkowane
 DE Baueimer
 RU Ведро оцинкованное
 CS Vědro
 RO Găleată
 HU Kőműves vödör
 ES Cubo



No.	Capacity / Pojemność [l]	
89560	5	900
89561	7	750
89562	10	600
89563	12	500
89564	15	350

EN Garden cart
 PL Wózek ogrodowy
 DE Gartenwagen
 RU Садовая тележка
 CS Zahradní vozík
 RO Carucior gradina
 HU Kerti kocsi
 ES Carrito de jardín



FEATURES:
 - Pneumatic wheels
CECHY:
 - Kola pompowane



No.	Max. load capacity / Maks. obciążenie [kg]	Dimensions / Wymiary [mm]	
90200	300	1020x515x400	1

EN Garden bucket
 PL Wiadro ogrodnicze
 DE Garten Eimer
 RU Ведро огородное

CS Zahradní vědro
 RO Găleată de grădină
 HU Kerti vödör
 ES Cubo de jardín



No.	Capacity / Pojemność [l]	
35600	15	500

EN Plastic bucket
 PL Wiadro budowlane
 DE Baueimer
 RU Ведро строительное
 CS Stavební vědro
 RO Găleată pt. construcții
 HU Kőműves vödör
 ES Cubo de obra



No.	Capacity / Pojemność [l]	
06388	10	900
06390	12	680
06393	16	450
06392	20	390

EN Garden tipper trolley
 PL Wózek ogrodowy z wywrotką
 DE Gartenwagen mit Kippkarre
 RU Садовая тележка самосвал
 CS Zahradní vozík se sklápěčem
 RO Carucior gradina
 HU Kerti kocsi billenővel
 ES Carrito de jardín basculante

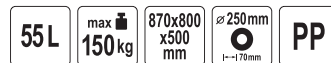

FEATURES:
 - Pneumatic wheels
CECHY:
 - Kola pompowane



No.	Max. load capacity / Maks. obciążenie [kg]	Dimensions / Wymiary [mm]	
90204	150	870x800x500	1

- EN Trash gripper
- PL Ręczny chwytak do śmieci
- DE Manueller Abfall-Greifer
- RU Ручной захват для мусора
- CS Ruční sběrač odpadků
- RO Cleste pt. adunat gunoi
- HU Kézi szemétszedő
- ES Recogedor manual de basura



No.	L [mm]	
89896	760	24

- EN Garden bags
- PL Worki ogrodowe
- DE Gartensäcke
- RU Мешки для огорода
- CS Zahradní pytle
- RO Saci gunoi pt. gradina
- HU Kerti szemétszák
- ES Bolsas de jardín



No.	Capacity / Pojemność [l]	Thickness / Grubość [µm]	pcs / szt.	
09481	120	60	10	15

- EN Waste bags for grass
- PL Worki perforowane na trawę
- DE Gartenmüllsäcke perforiert
- RU Мусорные пакеты прочные для листьев
- CS Perforované odpadové pytle na tráve
- RO Sac gunoi pt. iarba
- HU Szalagos kerti szemétszák
- ES Sacos perforadas para residuos de jardín



No.	Capacity / Pojemność [l]	Thickness / Grubość [µm]	pcs / szt.	
09483	120	35	10	25

- EN Aluminium telescopic ladder
- PL Aluminiowa drabina teleskopowa
- DE Teleskopleiter aus Aluminium
- RU Многофункциональная стремянка
- CS Hliníkový teleskopický žebřík
- RO Scară telescopică din aluminiu
- HU Alumínium kihúzható létra
- ES Escalera telescópica de aluminio



No.	Max. height / Maks. wysokość [m]	Rung quantity / Liczba stopni	
17701	3.8	13	1

- EN Garden bags with cord
- PL Worki ogrodowe z taśmą
- DE Gartensäcke mit Band
- RU Мешки для огорода с лентой

- CS Zahradní pytle zatahovací
- RO Saci gunoi pt. gradina cu strangere
- HU Szalagos kerti szemétszák
- ES Bolsas de jardín con cinta



No.	Capacity / Pojemność [l]	Thickness / Grubość [µm]	pcs / szt.	
09480	60	60	10	12
09482	120	60	10	15

- EN Perforated waste bags for leaves
- PL Worki perforowane na liście
- DE Gartenmüllsäcke perforiert
- RU Мусорные пакеты прочные для листьев

- CS Perforované odpadové pytle na list
- RO Szalagos kerti szemétszák
- HU Sac gunoi perforat pt. frunze
- ES Sacos perforadas para residuos de jardín



No.	Capacity / Pojemność [l]	Thickness / Grubość [µm]	pcs / szt.	
09484	200	40	10	12

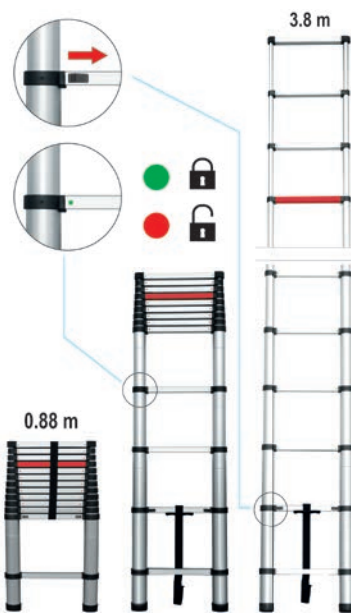

EN Aluminium telescopic ladder
 PL Aluminiowa drabina teleskopowa
 DE Teleskopleiter aus Aluminium
 RU Многофункциональная стремянка
 CS Hliníkový teleskopický žebřík
 RO Scară telesopică din aluminiu
 HU Alumínium kihúzóható létra
 ES Escalera telescópica de aluminio

max 3.8 m
 13 STEPS STOPNE
 max 150 kg
 AI NYLON



No.	Max. height / Maks. wysokość [m]	Rung quantity / Liczba stopni	
17702	3.8	13	1

EN 2-step ladder
 PL Drabina 2-stopniowa rozkładana
 DE 2-Stufen-Leiter
 RU 2-ступенчатая лестница
 CS Schůdky 2 stupně
 RO Scări cu 2 trepte
 HU 2 fokos lépcsők
 ES 2 pasos escaleras

90x47,5 x49 cm
 h 99 cm FOLDED ZLOZONA
 2 STEPS STOPNE
 38x26 cm
 max 150 kg
 SOFT GRIP MIEKKI UCHWYT
 PROTECTION RAIL WSPORNIK OCHRONNY



No.	Height / Wysokość [m]	Rung quantity / Liczba stopni	
17730	0.9	2	4

EN Multifold ladder platform
 PL Podest do drabiny wielofunkcyjnej
 DE Podest für die Multifunktionale Leiter
 RU Подставки для стремянки
 CS Plošina pro víceúčelový žebřík
 RO Platformă pt. scară multifuncțională
 HU Palló a multifunkciós létrához
 ES Descansillos para la escala multifuncional

830x295 mm
 560x295 mm
 ZINC PLATED OCYNKO-WANA
 max 150 kg

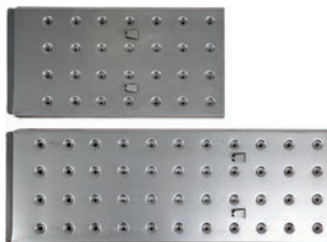

No.	For / Dla	
17705	17704	5

EN Multifold ladder
 PL Drabina wielofunkcyjna
 DE Mehrzweckleiter
 RU Лестница многофункциональная
 CS Multifunkční žebřík
 RO Scară multifuncțională
 HU Többcéltű létra
 ES Escalera multipropósito

max 3.4 m
 4x3 STEPS STOPNE
 16 kg
 max 150 kg



No.	Max. height / Maks. wysokość [m]	Rung quantity / Liczba stopni	
17704	3.4	4x3	1

EN 3-step ladder
 PL Drabina 3-stopniowa rozkładana
 DE 3-Stufen-Leiter
 RU 3-ступенчатая лестница
 CS Schůdky 3 stupně
 RO Scări cu 3 trepte
 HU 3 fokos lépcsők
 ES 3 pasos escaleras

115x47,5 x65 cm
 h 125 cm FOLDED ZLOZONA
 3 STEPS STOPNE
 38x26 cm
 max 150 kg
 SOFT GRIP MIEKKI UCHWYT
 PROTECTION RAIL WSPORNIK OCHRONNY



No.	Height / Wysokość [m]	Rung quantity / Liczba stopni	
17733	1.15	3	2



- EN Compost and gravel sieve
- PL Sito do kompostu i żwiru
- DE Sieb für Kompost und Kies
- RU Сито для компоста и гравия
- CS Prohazovací síto na kompost a štěrky
- RO Cedazo para estiércol y guija
- HU Sítő komposzt és zúrára
- ES Rosta komposztáláshoz és sóderhez



No.	Dimensions / Wymiary [cm]	Eyelet size / Rozmiar oczka [mm]	
34949	60x100	20x20	5/30

- EN Composter
- PL Kompostownik
- DE Kompostierer
- RU Компостовник
- CS Kompostér
- RO Compostor
- HU Komposztáló láda
- ES Compostador



No.	Capacity / Pojemność [l]	
35624	740	7

- EN Spreader
- PL Rozsiewacz
- DE Streuer
- RU Разбрасыватель-сеялка
- CS Sečič strojek
- RO Dispozitiv de imprastiere
- HU Magszóró
- ES Esparcidor



No.	Capacity / Pojemność [l]	
89860	3	12

- EN Composter
- PL Kompostownik
- DE Kompostierer
- RU Компостовник
- CS Kompostér
- RO Compostor
- HU Komposztáló láda
- ES Compostador



No.	Capacity / Pojemność [l]	
35623	480	10

- EN Composter
- PL Kompostownik
- DE Kompostierer
- RU Компостовник
- CS Kompostér
- RO Compostor
- HU Komposztáló láda
- ES Compostador



No.	Capacity / Pojemność [l]	
35625	1000	6

- EN Seeder
- PL Siewnik
- DE Streuwagen
- RU Сеялка
- CS Sečič stroj
- RO Semanatoare
- HU Magszóró
- ES Sembradora

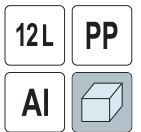

No.	Capacity / Pojemność [l]	
89870	12	1

EN Garden rack
 PL Stojak ogrodowy
 DE Gartengerätständer
 RU Садовая подставка
 CS Zahradní stojan
 RO Raft pt. gradina
 HU Kerti állvány
 ES Soporte para herramientas de jardinería



FLO

No.	Dimensions / Wymiary [mm]	Box icon
89990	840x740x350	1

EN Gutter mesh with hooks
 PL Siatka zabezpieczająca rynny z uchwytami mocującymi
 DE Schutzgitter für Rinnen mit Spannvorrichtungen
 RU Защитная сетка желоба с монтажными ручками
 CS Ochranná síť proti zanášení okapových žlabů s úchytkami
 RO Plasă de protecție burlane cu suporturi de protecție
 HU Lombfogó háló rögzítő fűlekkal
 ES Malla de protección para la canaleta con mandriles de sujeción

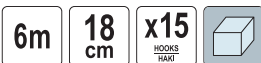

VOREL

No.	Box icon
69851	30

EN Portable car shower set
 PL Samochodowy prysznic turystyczny
 DE Campingdusche
 RU Портативный автомобиль душ
 CS Mobilní auto sprcha
 RO Dus portabil masina
 HU Autós hordozható zuhany
 ES Portátil ducha de coche

FUNCTIONS:
 - Taking shower, washing car, washing dishes and others

FUNKCJE:
 - Prysznic, mycie samochodu, mycie naczyń i inne



No.	Voltage / Napięcie [V d.c.]	Box icon
82991	12	5/10

EN Multiple holder
 PL Wieszak na narzędzia
 DE Werkzeughalter
 RU Подвеска для инструмента
 CS Věšák na nářadí
 RO Suport multiplu
 HU Szerszámakasztó
 ES Colgador para herramientas



FLO

No.	Box icon
89950	40

EN Rain pipe guard
 PL Osłona rury - sito do rury spustowej
 DE Fallrohrschutz
 RU Защитный кожух водосточного желоба
 CS Ochrana okapového svodu
 RO Protecție pt. burlane
 HU Sito eresz burkolat leeresztő csőhöz
 ES Protector de canalón tamiza para tubo de descarga



VOREL

No.	Ø [mm]	pcs / szt.	Box icon
69860	132	2	24

EN Portable car shower set
 PL Samochodowy prysznic turystyczny
 DE Campingdusche
 RU Портативный автомобиль душ
 CS Mobilní auto sprcha
 RO Dus portabil masina
 HU Autós hordozható zuhany
 ES Portátil ducha de coche

FUNCTIONS:
 - Taking shower, washing car, washing dishes, watering plants and others

FUNKCJE:
 - Prysznic, mycie samochodu, mycie naczyń, podlewanie roślin i inne

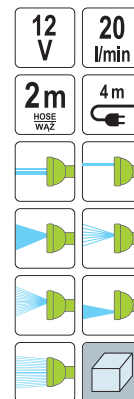

LUND

No.	Voltage / Napięcie [V d.c.]	Box icon
82992	12	10

LUND

- EN Garden extension cable CS Prodlužovací kabel zahradní
 PL Przedłużacz RO Prelungtor electric
 DE Gartenverlängerungskabel HU Kerti hosszabbító
 RU Электроудлинитель ES Cable de extensión para jardín

230V~ 50Hz 2x 1.0 mm² IP20



No.	L [m]	☐
82671	10	10
82673	20	10
82675	30	5

- EN Gas BBQ grill PL Grill gazowy
 DE Gasgrill RU Газовый гриль
 CS Plynový gril RO Grătarul cu gaz
 HU Gázgrill ES Barbacoa de gas

5.5 kW x2 48.5x37.5 cm ENAMEL GRATE RUSZT EMALOWANY FOLDED SHELVES SKŁADANE POŁKI



LUND

No.	☐
99644	1

- EN Gas BBQ grill PL Grill gazowy
 DE Gasgrill RU Газовый гриль
 CS Plynový gril RO Grătarul cu gaz
 HU Gázgrill ES Barbacoa de gas

8.4+3.2 kW 3+1 x2 47.5x38 cm CHROME GRATE RUSZT CHROMOWANY



LUND

No.	☐
99646	1

- EN Gas BBQ grill PL Grill gazowy
 DE Gasgrill RU Газовый гриль
 CS Plynový gril RO Grătarul cu gaz
 HU Gázgrill ES Barbacoa de gas

5.5+2.5 kW 2+1 48.5x37.5 cm ENAMEL GRATE RUSZT EMALOWANY



LUND

No.	☐
99645	1

- EN Gas BBQ grill PL Grill gazowy
 DE Gasgrill RU Газовый гриль
 CS Plynový gril RO Grătarul cu gaz
 HU Gázgrill ES Barbacoa de gas

11.2+3.2 kW 4+1 x2 52.5x38 cm CHROME GRATE RUSZT CHROMOWANY 360° 4x 2x BRAME HANULEC



LUND

No.	☐
99647	1

EN BBQ gas and charcoal grill
 PL Grill gazowo-węglowy
 DE Gas- und Kohlegrill
 RU Газово-угольный гриль
 CS Gril na plyn a uhlí
 RO Gratar pe gaz si carbuni
 HU Kombinált grill, gáz, szén
 ES Barbacoa a gas y carbón

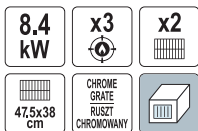

LUND

No.

99649



1

EN Gas BBQ grill
 PL Grill gazowy
 DE Gasgrill
 RU Газовый гриль
 CS Plynový gril
 RO Gratarul cu gaz
 HU Gázgrill
 ES Barbacoa de gas

FEATURES:

- 4 main burners
- Side burner
- Ignition in the knob
- Thermo gauge

CECHY:

- 4 palniki główne
- Palnik boczny
- Zapalnik w pokrętle

- Sliding tray for fat
- Side handles
- Wheels with a brake

CECHY:

- Wysuwana taca na tłuszcz
- Uchwyty boczne
- Koła z hamulcem

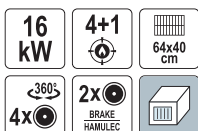

LUND

No.

99643



1

EN Gas BBQ grill
 PL Grill gazowy
 DE Gasgrill
 RU Газовый гриль
 CS Plynový gril
 RO Gratarul cu gaz
 HU Gázgrill
 ES Barbacoa de gas



LUND

No.

99642



1

EN Gas BBQ grill
 PL Grill gazowy
 DE Gasgrill
 RU Газовый гриль
 CS Plynový gril
 RO Gratarul cu gaz
 HU Gázgrill
 ES Barbacoa de gas



LUND

No.

99651



1

EN Gas BBQ grill
 PL Grill gazowy
 DE Gasgrill
 RU Газовый гриль
 CS Plynový gril
 RO Grătarul cu gaz
 HU Gázgrill
 ES Barbacoa de gas

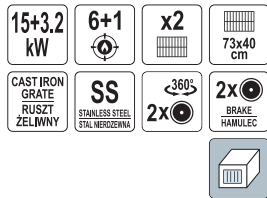

LUND

No.		
99653		1

EN Charcoal BBQ grill
 PL Grill węglowy z termometrem
 DE Holzkohlegrill
 RU Гриль-барбекю угольный

CS Gril na dřevěné uhlí
 RO Grătar carbuni
 HU Faszén grill
 ES Barbacoa de carbón y lena

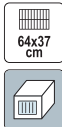

FEATURES:

- Firebowl height: 85.5 cm
- Smoker
- Thermo gauge
- Air flow
- Chimney
- Ashpan

CECHY:

- Wysokość paleniska: 85.5 cm
- Wędzarnia
- Termometr
- Obieg powietrza
- Komin
- Popielnik



LUND

No.		
99587		1

EN Cast iron plate
 PL Płyta żeliwna
 DE Gusseisenplatte
 RU Чугунная пластина
 CS Litinová deska
 RO Tava oțel
 HU Öntöttvas lemez
 ES Placa de acero fundido



LUND

No.	For / Dla	
99659	99642, 99643, 99651, 99652	5

EN Gas regulator and hose
 PL Reduktor z węzłem
 DE Schlauch und Regler
 RU Газовый шланг с редуктором
 CS Regulátor plynu a hadice
 RO Furtun pt. gaz cu regulator
 HU Nyomásszabályozó szett
 ES Regulador de gas con manguera



VOREL

No.	L [m]	
99670	1.0	16
99671	1.5	16

EN Big barrel BBQ with smoker
 PL Grill ogrodowy z termometrem i wędzarnią
 DE Grillwagen mit Temperaturanzeige und Räucherei
 RU Барбекю-коптильня с термометром
 CS Zahradní udlina s grilem
 RO Grătar cu afumătoare și termometru
 HU Kültéri faszénes grill
 ES Barbacoa de carbón con soporte

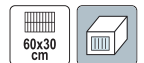

FEATURES:

- Thermo gauge
- Smoker
- Chimney

CECHY:

- Termometr
- Wędzarnia
- Komin



LUND

No.		
99513		1

EN Charcoal BBQ grill
 PL Grill węglowy z termometrem
 DE Holzkohlegrill
 RU Гриль-барбекю угольный
 CS Gril na dřevěné uhlí
 RO Gratar carbuni
 HU Faszén grill
 ES Barbacoa de carbón y lena



FEATURES:

- Firebowl height: 88 cm
- Grill adjustment system
- Warming rack: 65 x 20.5 cm
- Thermo gauge
- Folding shelves
- Air flow
- Bottle opener
- Ashpan
- Poker

CECHY:

- Wysokość paleniska: 88 cm
- System regulacji rusztu
- Kratka podgrzewająca: 65 x 20.5 cm
- Termometr
- Składane półki
- Obieg powietrza
- Otwieracz do butelek
- Popielnik
- Pogrzebacz



LUND

No.
99533



1

EN Big barrel BBQ with thermo gauge
 PL Grill ogrodowy z termometrem
 DE Grillwagen mit Temperaturanzeige
 RU Барбекю-коптильня с термометром
 CS Zahradní udirna s grilem
 RO Grătar cu afumătoare si termometru
 HU Kültéri faszénes grill
 ES Barbacoa de carbón con soporte

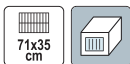

FEATURES:

- Metal fireplace
- Thermo gauge
- Air flow
- Ashpan

CECHY:

- Płyta żaroodporna
- Termometr
- Obieg powietrza
- Popielnik



LUND

No.
99512



1

EN Charcoal BBQ grill
 PL Grill węglowy z termometrem
 DE Holzkohlegrill
 RU Гриль-барбекю угольный

CS Gril na dřevěné uhlí
 RO Gratar carbuni
 HU Faszén grill
 ES Barbacoa de carbón y lena

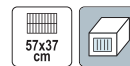

FEATURES:

- Firebowl height: 85 cm
- Grill adjustment system
- Air flow
- Thermo gauge
- Ashpan
- Folding shelf

CECHY:

- Wysokość paleniska: 85 cm
- System regulacji rusztu
- Obieg powietrza
- Termometr
- Popielnik
- Składana półka



LUND

No.
99588



1

EN Charcoal BBQ grill
 PL Grill ogrodowy z termometrem
 DE Holzkohlegrill
 RU Гриль-барбекю угольный
 CS Gril na dřevěné uhlí
 RO Gratar carbuni
 HU Faszén grill
 ES Barbacoa de carbón y lena

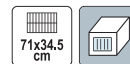

FEATURES:

- Firebowl height: 75 cm
- 2 wooden shelves
- Thermo gauge
- Air flow
- Ashpan

CECHY:

- Wysokość paleniska: 75 cm
- 2 drewniane półki
- Termometr
- Obieg powietrza
- Popielnik



LUND

No.
99586



1

EN Charcoal BBQ grill
 PL Grill węglowy
 DE Holzkohlegrill
 RU Гриль угольный
 CS Gril na dřevěné uhlí
 RO Gratar carbuni
 HU Faszén grill
 ES Barbacoa de carbón y lena

FEATURES:

- Adjustable cooking height
- Zinc plated charcoal plates
- Folding shelf

CECHY:

- Regulowana wysokość rusztów
- Ocynkowane płyty na węgiel
- Składana półka

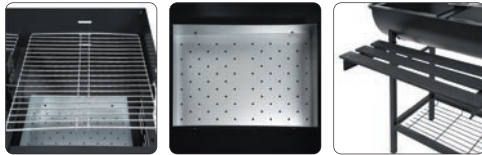
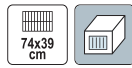

LUND

No.
99495



1

EN Folding charcoal grill
 PL Grill węglowy składany
 DE Holzkohle-Faltgrill
 RU Гриль угольный переносный
 CS Přenosný gril
 RO Gratar portabil
 HU Hordozható faszénes grill
 ES Parrilla portátil



- FEATURES:**
- Folded size: 48 x 29 x 21 cm
 - Air flow

CECHY:

- Wymiary po złożeniu: 48 x 29 x 21 cm
- Obieg powietrza



LUND

No.
99594



1

EN Big barrel BBQ with thermo gauge
 PL Grill ogrodowy z termometrem
 DE Grillwagen mit Temperaturanzeige
 RU Барбекю-коптильня с термометром
 CS Zahradní uřina s grilem
 RO Gratar cu afumătoare si termometru
 HU Kultéri faszénes grill
 ES Barbacoa de carbón con soporte

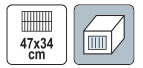

FEATURES:

- Thermo gauge
- Air flow
- Chimney

CECHY:

- Termometr
- Obieg powietrza
- Komin



LUND

No.
99514



1

EN Charcoal BBQ grill
 PL Grill węglowy
 DE Holzkohlegrill
 RU Гриль-барбекю угольный
 CS Gril na dřevěné uhlí
 RO Gratar carbuni
 HU Faszén grill
 ES Barbacoa de carbón y lena



FEATURES:

- Thermo gauge
- Air flow
- Ashpan

CECHY:

- Termometr
- Obieg powietrza
- Popielnik



LUND

No.
99584



1

EN Charcoal BBQ grill
 PL Grill węglowy
 DE Holzkohlegrill
 RU Гриль-барбекю угольный
 CS Gril na dřevěné uhlí
 RO Gratar carbuni
 HU Faszén grill
 ES Barbacoa de carbón y lena

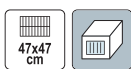

FEATURES:

- Air flow
 - Metal shelf
- CECHY:**
- Obieg powietrza
 - Metalowa półka



LUND

No.
99580



1

EN Charcoal BBQ grill
 PL Grill węglowy
 DE Holzkohlegrill
 RU Гриль-барбекю угольный
 CS Gril na dřevěné uhlí
 RO Gratar carbuni
 HU Faszén grill
 ES Barbacoa de carbón y lena

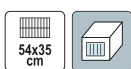

FEATURES:

- Firebowl height: 73 cm
- Warming rack: 46 x 7 cm
- 2 metal shelves

CECHY:

- Wysokość paleniska: 73 cm
- Kratka podgrzewająca: 46 x 7 cm
- 2 metalowe półki



LUND

No.
99582



1

EN Charcoal BBQ grill
 PL Grill węglowy
 DE Holzkohlegrill
 RU Гриль-барбекю угольный
 CS Gril na dřevěné uhlí
 RO Gratar carbuni
 HU Faszén grill
 ES Barbacoa de carbón y lena

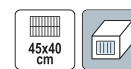

FEATURES:

- Grill adjustment
- Air flow
- 3 wooden shelves

CECHY:

- Regulacja ruszty
- Obieg powietrza
- 3 drewniane półki



LUND

No.
99581



1

EN Charcoal BBQ grill
 PL Grill węglowy
 DE Holzkohlegrill
 RU Гриль-барбекю угольный
 CS Gril na dřevěné uhlí
 RO Gratar carbuni
 HU Faszén grill
 ES Barbacoa de carbón y lena

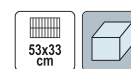

FEATURES:

- Firebowl height: 65 cm
- Warming rack
- 3 wooden shelves

CECHY:

- Wysokość paleniska: 65 cm
- Kratka podgrzewająca
- 3 drewniane półki



LUND

No.
99589



1

EN Charcoal BBQ grill
 PL Grill węglowy z półką
 DE Holzkohlegrill
 RU Гриль-барбекю угольный
 CS Gril na dřevěné uhlí
 RO Gratar carbuni
 HU Faszén grill
 ES Barbacoa de carbón y lena

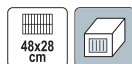

- FEATURES:**
- Firebowl height: 69.5 cm
 - Wooden handle
 - 2 wooden shelves
- CECHY:**
- Wysokość paleniska: 69.5 cm
 - Drewniany uchwyt
 - 2 drewniane półki



LUND

No.
99585



EN Charcoal BBQ grill
 PL Grill węglowy
 DE Holzkohlegrill
 RU Гриль угольный

CS Gril na dřevěné uhlí
 RO Gratar carbuni
 HU Faszén grill
 ES Barbacoa de carbón y lena

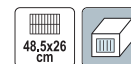

- FEATURES:**
- Firebowl height: 66 cm
 - Wooden handle
 - Wooden shelf
- CECHY:**
- Wysokość paleniska: 66 cm
 - Drewniany uchwyt
 - Drewniana półka



LUND

No.
99592



EN Charcoal BBQ grill
 PL Grill węglowy z pokrywą
 DE Holzkohlegrill
 RU Гриль-барбекю угольный
 CS Gril na dřevěné uhlí
 RO Gratar carbuni
 HU Faszén grill
 ES Barbacoa de carbón y lena



- FEATURES:**
- Firebowl height: 59 cm
 - Air flow
 - Ashpan
 - Rain cover
- CECHY:**
- Wysokość paleniska: 59 cm
 - Obieg powietrza
 - Popielnik
 - Pokrowiec przeciwdeszczowy



LUND

No.
99583



EN Charcoal BBQ grill
 PL Grill węglowy z pokrywą
 DE Holzkohlegrill
 RU Гриль-барбекю угольный
 CS Gril na dřevěné uhlí
 RO Gratar carbuni
 HU Faszén grill
 ES Barbacoa de carbón y lena

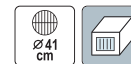

- FEATURES:**
- Firebowl height: 59 cm
 - Air flow
 - Ashpan
- CECHY:**
- Wysokość paleniska: 59 cm
 - Obieg powietrza
 - Popielnik



LUND

No.
99591



EN Folding charcoal grill
 PL Grill węglowy składany
 DE Holzkohle-Faltgrill
 RU Гриль угольный складной
 CS Přenosný gril
 RO Gratar portabil
 HU Hordozható faszenes grill
 ES Parrilla portátil



FEATURES:
 - Folded size: 43 x 23 x 5 cm
 - Air flow

CECHY:
 - Wymiary po złożeniu: 43 x 23 x 5 cm
 - Obieg powietrza



LUND

No. 99593  6

EN Folding charcoal grill
 PL Grill węglowy składany
 DE Holzkohle-Faltgrill
 RU Гриль угольный складной
 CS Přenosný gril
 RO Gratar portabil
 HU Hordozható faszenes grill
 ES Parrilla portátil



FEATURES:
 - Folded size: 83 x 46 x 44 cm
 - Frying plate: 31.5 x 27 cm
 - Worktable
 - Ashpan
 - Poker

CECHY:
 - Wymiary po złożeniu: 83 x 46 x 44 cm
 - Płyta do smażenia: 31.5 x 27 cm
 - Stolik roboczy
 - Popielnik
 - Pogrzebacz



LUND

No. 99595  1

EN Folding charcoal grill
 PL Grill węglowy składany
 DE Holzkohle-Faltgrill
 RU Гриль угольный переносный
 CS Přenosný gril
 RO Gratar portabil
 HU Hordozható faszenes grill
 ES Parrilla portátil



FEATURES:
 - Folded size: 41 x 36.5 x 20 cm
 - Warming rack: 31 x 17 cm
 - Air flow

CECHY:
 - Wymiary po złożeniu: 41 x 36.5 x 20 cm
 - Kratka podgrzewająca: 31 x 17 cm
 - Obieg powietrza



LUND

No. 99483  1

EN Smoker
 PL Wędzarnia
 DE Räucherer
 RU Коптильня
 CS Udírna
 RO Afumător
 HU Füstölővel
 ES Ahumador



LUND

No. 99633  1

EN Smoker
 PL Wędzarnia
 DE Räucherei
 RU Коптильня
 CS Udřina
 RO Afumător
 HU Füstölővel
 ES Ahumador

FEATURES:

- Thermo gauge
- 2 x cooking grill
- 2 x porcelain bowl
- 4 x vent

CECHY:

- Termometr
- 2 ruszty
- 2 porcelanowe misy
- 4 otwory wentylacyjne



54x51
x100
cm

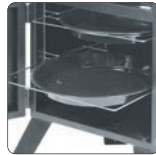

LUND

No.

99747



1

EN Fire pit
 PL Palenisko ogrodowe
 DE Gartenfeuerstätte
 RU Садовый очаг
 CS Zahradní ohniště
 RO Gratar tip vatra
 HU Kerti tűzrakó
 ES Fogón para jardín

FEATURES:

- Cooking grill
- Folding legs

CECHY:

- Ruszt
- Składane nóżki

56x39
cm

x3
LESS
NOZZE



LUND

No.

99701



1

EN Fire pit
 PL Palenisko ogrodowe
 DE Gartenfeuerstätte
 RU Садовый очаг
 CS Zahradní ohniště
 RO Gratar tip vatra
 HU Kerti tűzrakó
 ES Fogón para jardín

FEATURES:

- Log store
- Cooking grill
- Poker

CECHY:

- Drewutnia
- Ruszt
- Pogrzebacz

58x58
x55
cm

Ø50
cm

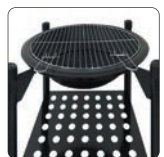

LUND

No.

99713



1

EN Round chain grill
 PL Grill wiszący na trójnogu
 DE Dreibeckhängegrill
 RU Подвесной гриль на треноге
 CS Závěsný gril na trójnožce
 RO Gratar cu trepid si lant
 HU Állványos függő grill
 ES Parrilla colgante con trípode

70x70
x152
cm

Ø52
cm

67
30
cm



LUND

No.

99524



1

EN Fire pit
 PL Palenisko ogrodowe
 DE Gartenfeuerstätte
 RU Садовый очаг
 CS Zahradní ohniště
 RO Gratar tip vatra
 HU Kerti tűzrakó
 ES Fogón para jardín

INCLUDED:

- Poker

W ZESTAWIE:

- Pogrzebacz

42x53
cm

x4
LESS
NOZZE

x2
HANDLES
UCHWYTY



LUND

No.

99702



1

EN Fire pit
 PL Palenisko ogrodowe
 DE Gartenfeuerstätte
 RU Садовый очаг
 CS Zahradní ohniště
 RO Gratar tip vatra
 HU Kerti tűzrakó
 ES Fogón para jardín

FEATURES:
 - Cooking grill
 - Poker

CECHY:
 - Ruszt
 - Pogrzebacz



LUND

No.	
99714	1

EN Fire pit
 PL Palenisko ogrodowe
 DE Gartenfeuerstätte
 RU Садовый очаг
 CS Zahradní ohniště
 RO Gratar tip vatra
 HU Kerti tűzrakó
 ES Fogón para jardín



LUND

No.	
99711	1

EN BBQ cover
 PL Pokrowiec na grilla
 DE Wetterschutzhaube
 RU Обложка гриля
 CS Obal na gril
 RO Gratar acoperă
 HU Grill takaróponyva
 ES Cubierta de barbacoa



LUND

No.	Dimensions / Wymiary [cm]	For / Dla	
99761	130x50x95	99642, 99647, 99649, 99651	20

EN Fire pit
 PL Palenisko ogrodowe
 DE Gartenfeuerstätte
 RU Садовый очаг
 CS Zahradní ohniště
 RO Gratar tip vatra
 HU Kerti tűzrakó
 ES Fogón para jardín

FEATURES:
 - Cooking grill
 - Poker

CECHY:
 - Ruszt
 - Pogrzebacz



LUND

No.	
99703	1

EN BBQ cover
 PL Pokrowiec na grilla
 DE Wetterschutzhaube
 RU Обложка гриля
 CS Obal na gril
 RO Gratar acoperă
 HU Grill takaróponyva
 ES Cubierta de barbacoa



LUND

No.	Dimensions / Wymiary [cm]	For / Dla	
99760	100x60x95	99512, 99514, 99519, 99586, 99588	20

EN BBQ cover
 PL Pokrowiec na grilla
 DE Wetterschutzhaube
 RU Обложка гриля
 CS Obal na gril
 RO Gratar acoperă
 HU Grill takaróponyva
 ES Cubierta de barbacoa

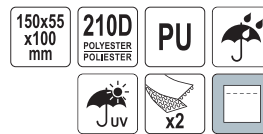

LUND

No.	Dimensions / Wymiary [cm]	For / Dla	
99762	150x55x100	99643, 99649, 99652, 99653	20

25

Sanitary ware & hydraulics
Armatura sanitarna i hydraulika

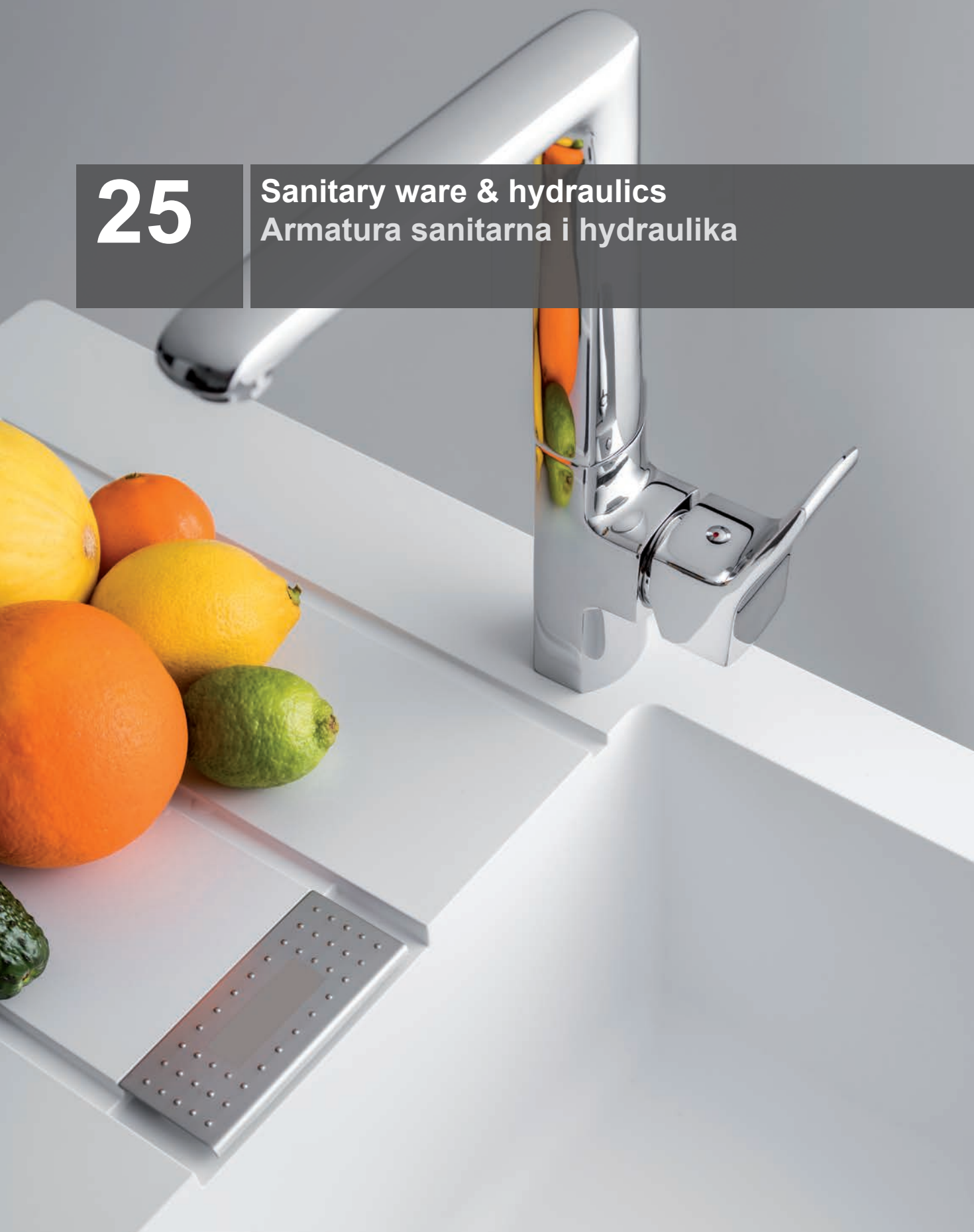

Mixers, faucets
Baterie

.....484-501

**Linear drains**
Odpływy liniowe

.....501-503

**Pop-up wastes**
Korki automatyczne

.....504

**Shower handles**
Słuchawki prysznicowe

.....504-508

**Shower & connecting hoses**
Wężę prysznicowe i przyłączeniowe

.....509-511

**Bathroom & shower sets**
Komplety łazienkowe i prysznicowe

.....512-515

**Bathroom accessories**
Akcesoria łazienkowe

.....515-521

**Toilet seats**
Deski toaletowe

.....521-522

**Bathroom ceramic**
Ceramika łazienkowa

.....522-523

**Bathroom scales**
Wagi łazienkowe

.....524

**Plastic stools**
Stołki plastikowe

.....524-525

**Hydraulic accessories**
Akcesoria hydrauliczne

.....525-527



<p>The exclusive composition with sapphire hardness developed by famous spanish company.</p> <p>Głowica z wkładem ceramicznym o twardości szafiru renomowanego hiszpańskiego producenta.</p>  <p>CORUNDOx</p>	<p>Mixing water flow with intake air reduces consumption by half, without splashing.</p> <p>Zmieszany strumień wody z zasysanym powietrzem oszczędza zużycie o połowę i nie chlapie.</p>  <p>ECOflow</p>	<p>The most effective way to save water and energy - flowing only cold water when the lever is centered.</p> <p>Najefektywniejszy sposób oszczędzania wody i energii - dla uchwytu usytuowanego na wprost popłynie tylko zimna woda.</p>  <p>ECOstart</p>
<p>Nano-size cavities on the disc surface to keep the lubrication, provides a higher durability and an improved smooth feeling.</p> <p>Mikroząglębienia dzięki którym smar w głowicy nie wypłukuje się i głowica działa gładko przez wiele lat.</p>  <p>NANOCave</p>	<p>Rubbing the lime away with a finger and the stream is like in brand new faucet again.</p> <p>Przetarcie palcem usuwa kamień i przywraca strumień jak w nowej baterii.</p>  <p>SMARTclean</p>	<p>Reduced noise thanks to silencer in eccentric wall connector.</p> <p>Obniżony hałas dzięki użyciu tłumików w złączach.</p>  <p>LOWnoise</p>
<p>Ergonomic faucet provides more space for comfortable using.</p> <p>Ergonomiczna bateria zapewniająca przestrzeń dla wygodnego użytkownika.</p>  <p>ERGOsize</p>	<p>Simple and effective installation thanks to the large nut that screw without any tools.</p> <p>Łatwy i trwały montaż dzięki dużej nakrętce, którą przykręcisz bez użycia jakiegokolwiek narzędzi.</p>  <p>SMARTnut</p>	<p>Improved lime protection: integrated honeycomb structure replaces conventional wire mesh screens prone to lime build-up.</p> <p>Lepsza ochrona przeciwkapienna: struktura plastra miodu zastępuje klasyczne wkłady siateczkowe, które mają tendencję do zarastania.</p>  <p>HEXAGONal</p>
<p>Body without holes and nooks that could accumulate dirt and microorganisms.</p> <p>Korpus bez otworów i zakamarków, które gromadzą brud i mikroorganizmy.</p>  <p>CLEANbody</p>	<p>Innovative mounting system for hose nut and safe servicing aerator.</p> <p>Innowacyjny system montażu wężyków i bezpiecznego serwisowania aeratora.</p>  <p>SMARTtool</p>	<p>Multi-purpose hydraulic wrench for installation of faucet and small plumbing work.</p> <p>Wielofunkcyjny klucz hydrauliczny do montażu baterii i drobnych prac hydraulicznych.</p>  <p>SMARTtool</p>
<p>High quality stainless steel is characterized by increased resistance to chemicals, preserving its appearance even after many years of use.</p> <p>Wysokiej jakości stal nierdzewna charakteryzuje się zwiększoną odpornością na chemikalia, zachowując swój wygląd nawet po wielu latach użytkowania.</p>  <p>Sus304</p>	<p>Stainless steel is free of zinc and lead - toxic elements, which in micro quantities get into the water in brass faucets.</p> <p>Stal nierdzewna jest wolna od cynku i ołowiu - toksycznych pierwiastków, które w mikro ilościach dostają się do wody w mosiężnych kranach.</p>  <p>NOlead</p>	<p>All parts are made of stainless steel, so they are rust-resistant.</p> <p>Wszystkie części wykonane są ze stali nierdzewnej i są odporne na rdzę.</p>  <p>FULL steel</p>

- EN Basin mixer
- PL Bateria umywalkowa
- DE Einhand-Waschtischbatterie
- RU Смеситель для раковины
- CS Umyvadlová baterie
- RO Bateria lavoar
- HU Mosdó csaptelep
- ES Monomando de lavabo

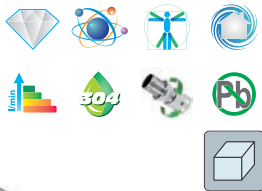

FALA

No.	Series / Seria	
75801	Steely 1	10

- EN Basin mixer
- PL Bateria umywalkowa
- DE Einhand-Waschtischbatterie
- RU Смеситель для раковины
- CS Umyvadlová baterie
- RO Bateria lavoar
- HU Mosdó csaptelep
- ES Monomando de lavabo

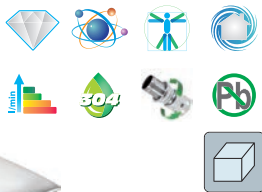

FALA

No.	Series / Seria	
75803	Steely 3	10

- EN Basin mixer
- PL Bateria umywalkowa
- DE Einhand-Waschtischbatterie
- RU Смеситель для раковины
- CS Umyvadlová baterie
- RO Bateria lavoar
- HU Mosdó csaptelep
- ES Monomando de lavabo



FALA

No.	Series / Seria	
75802	Steely 2	12

- EN Basin mixer
- PL Bateria umywalkowa
- DE Einhand-Waschtischbatterie
- RU Смеситель для раковины
- CS Umyvadlová baterie
- RO Bateria lavoar
- HU Mosdó csaptelep
- ES Monomando de lavabo



FALA

No.	Series / Seria	
75804	Steely 4	10

EN Shower column
 PL Kolumna prysznicowa
 DE Duschsäule
 RU Душевая штанга
 CS Sprchový sloup
 RO Coloană de duș
 HU Zuhanyoszlop
 ES Columna de ducha



FALA

No.	Series / Seria	Box
75662	Steely 1	5

EN Shower column
 PL Kolumna prysznicowa
 DE Duschsäule
 RU Душевая штанга
 CS Sprchový sloup
 RO Coloană de duș
 HU Zuhanyoszlop
 ES Columna de ducha



FALA

No.	Series / Seria	Box
75664	Steely 3	5

EN Single-lever sink mixer
 PL Bateria zlewozmywakowa
 DE Einhand-Spültischbatterie
 RU Смеситель для кухни
 CS Dřezová baterie
 RO Baterie stativă bucătărie
 HU Mosogató csaptelep
 ES Monomando de fregadero



FALA

No.	Series / Seria	Box
75716	Steely 1	10

EN Shower column
 PL Kolumna prysznicowa
 DE Duschsäule
 RU Душевая штанга
 CS Sprchový sloup
 RO Coloană de duș
 HU Zuhanyoszlop
 ES Columna de ducha



FALA

No.	Series / Seria	Box
75663	Steely 2	5

EN Shower column
 PL Kolumna prysznicowa
 DE Duschsäule
 RU Душевая штанга
 CS Sprchový sloup
 RO Coloană de duș
 HU Zuhanyoszlop
 ES Columna de ducha



FALA

No.	Series / Seria	Box
75665	Steely 4	5

EN Single-lever sink mixer
 PL Bateria zlewozmywakowa
 DE Einhand-Spültischbatterie
 RU Смеситель для кухни
 CS Dřezová baterie
 RO Baterie stativă bucătărie
 HU Mosogató csaptelep
 ES Monomando de fregadero



FALA

No.	Series / Seria	Box
75718	Steely 2	10

EN Single-lever sink mixer
 PL Bateria zlewozmywakowa
 DE Einhand-Spültischbatterie
 RU Смеситель для кухни
 CS Dřezová baterie
 RO Baterie stativă bucatărie
 HU Mosogató csaptelep
 ES Monomando de fregadero



FALA

No.	Series / Seria	Box
75719	Steely 3	10

EN Single-lever sink mixer
 PL Bateria zlewozmywakowa
 DE Einhand-Spültischbatterie
 RU Смеситель для кухни
 CS Dřezová baterie
 RO Baterie stativă bucatărie
 HU Mosogató csaptelep
 ES Monomando de fregadero



FALA

No.	Series / Seria	Box
75806	Steely 5	5

EN Built-in shower system
 PL Podtynkowy system prysznicowy
 DE Unterputz-duschsystem
 RU Душевой гарнитур скрытого монтажа
 CS Sprchový podomítkový set
 RO Set de dus incastrat baterie
 HU Falsik alatti zuhanyszett
 ES Sistema dual de ducha empotrado



FALA

No.	Series / Seria	Box
75871	Steely S	4

EN Single-lever sink mixer
 PL Bateria zlewozmywakowa
 DE Einhand-Spültischbatterie
 RU Смеситель для кухни
 CS Dřezová baterie
 RO Baterie stativă bucatărie
 HU Mosogató csaptelep
 ES Monomando de fregadero



FALA

No.	Series / Seria	Box
75805	Steely 4	5

EN Built-in shower system
 PL Podtynkowy system prysznicowy
 DE Unterputz-duschsystem
 RU Душевой гарнитур скрытого монтажа
 CS Sprchový podomítkový set
 RO Set de dus incastrat baterie
 HU Falsik alatti zuhanyszett
 ES Sistema dual de ducha empotrado



FALA

No.	Series / Seria	Box
75870	Steely R	4

EN Basin mixer
 PL Bateria umywalkowa
 DE Einhand-Waschtischbatterie
 RU Смеситель для раковины
 CS Umyvadlová baterie
 RO Baterie lavoar
 HU Mosdó csaptelep
 ES Monomando de lavabo



FALA

No.	Series / Seria	Box
75807	Retro Black 1	12

EN Bath mixer
 PL Bateria wannowa
 DE Einhand-Wannenbatterie
 RU Смеситель для ванны
 CS Vanové baterie
 RO Baterie cada / dus
 HU Egykaros kádcsaptelep
 ES Monomando para bañoo



FALA

No.	Series / Seria	
75808	Retro Black 1	12

EN Basin mixer
 PL Bateria umywalkowa
 DE Einhand-Waschtischbatterie
 RU Смеситель для раковины
 CS Umyvadlová baterie
 RO Baterie lavoar
 HU Mosdó csaptelep
 ES Monomando de lavabo



FALA

No.	Series / Seria	
75811	Retro Black 2	12

EN Shower column
 PL Kolumna prysznicowa
 DE Duschsäule
 RU Душевая штанга
 CS Sprchový sloup
 RO Coloană de duș
 HU Zuhanyoszlop
 ES Columna de ducha



FALA

No.	Series / Seria	
75813	Retro Black 2	5

EN Shower column
 PL Kolumna prysznicowa
 DE Duschsäule
 RU Душевая штанга
 CS Sprchový sloup
 RO Coloană de duș
 HU Zuhanyoszlop
 ES Columna de ducha



FALA

No.	Series / Seria	
75809	Retro Black 1	5

EN Basin mixer
 PL Bateria umywalkowa wysoka
 DE Einhand-Waschtischbatterie
 RU Смеситель для раковины
 CS Umyvadlová baterie
 RO Baterie lavoar
 HU Mosdó csaptelep
 ES Monomando de lavabo



FALA

No.	Series / Seria	
75812	Retro Black 2	12

EN Basin mixer
 PL Bateria umywalkowa
 DE Einhand-Waschtischbatterie
 RU Смеситель для раковины
 CS Umyvadlová baterie
 RO Baterie lavoar
 HU Mosdó csaptelep
 ES Monomando de lavabo



FALA

No.	Series / Seria	
75814	Retro Black 3	12

EN Shower column
 PL Kolumna prysznicowa
 DE Duschsäule
 RU Душевая штанга
 CS Sprchový sloup
 RO Coloană de duș
 HU Zuhanyoszlop
 ES Columna de ducha



FALA

No.	Series / Seria	
75829	Retro Bronze 1	5

EN Basin mixer
 PL Bateria umywalkowa wysoka
 DE Einhand-Waschtischbatterie
 RU Смеситель для раковины
 CS Umyvadlová baterie
 RO Baterie lavoar
 HU Mosdó csaptelep
 ES Monomando de lavabo



FALA

No.	Series / Seria	
75837	Retro Bronze 2	12

EN Single-lever sink mixer
 PL Bateria zlewozmywakowa
 DE Einhand-Spültischbatterie
 RU Смеситель для кухни
 CS Dřezová baterie
 RO Baterie stativă bucatărie
 HU Mosogató csaptelep
 ES Monomando de fregadero



FALA

No.	Series / Seria	
75834	Retro Black 1	12

EN Basin mixer
 PL Bateria umywalkowa
 DE Einhand-Waschtischbatterie
 RU Смеситель для раковины
 CS Umyvadlová baterie
 RO Baterie lavoar
 HU Mosdó csaptelep
 ES Monomando de lavabo



FALA

No.	Series / Seria	
75836	Retro Bronze 2	12

EN Shower column
 PL Kolumna prysznicowa
 DE Duschsäule
 RU Душевая штанга
 CS Sprchový sloup
 RO Coloană de duș
 HU Zuhanyoszlop
 ES Columna de ducha



FALA

No.	Series / Seria	
75838	Retro Bronze 2	5

EN Single-lever sink mixer
 PL Bateria zlewozmywakowa
 DE Einhand-Spültischbatterie
 RU Смеситель для кухни
 CS Dřezová baterie
 RO Baterie stativă bucatărie
 HU Mosogató csaptelep
 ES Monomando de fregadero



FALA

No.	Series / Seria	
75835	Retro Black 2	12

EN Single-lever shower mixer
 PL Bateria prysznicowa
 DE Einhand-Brausebatterie
 RU Смеситель для душа
 CS Sprchová baterie
 RO Baterie dus
 HU Egykaros zuhanycsaptelep
 ES Monomando de ducha



FALA

No.	Series / Seria	
75743	Tarragona	10

EN Bath mixer
 PL Bateria wannowa
 DE Einhand-Wannenbatterie
 RU Смеситель для ванны
 CS Vanové baterie
 RO Baterie cada / dus
 HU Egykaros kádcsaptelep
 ES Monomando para bañoo

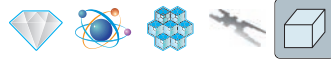

FALA

No.	Series / Seria	
75762	Soria	8

EN Single-lever sink mixer
 PL Bateria zlewozmywakowa
 DE Einhand-Spültischbatterie
 RU Смеситель для раковины
 CS Dřezová baterie
 RO Baterie stativă bucatărie
 HU Mosogató csaptelep
 ES Monomando de fregadero



FALA

No.	Series / Seria	
75764	Soria	8

EN Basin mixer
 PL Bateria umywalkowa
 DE Einhand-Waschtischbatterie
 RU Смеситель для раковины
 CS Umyvadlová baterie
 RO Baterie lavoar
 HU Mosdó csaptelep
 ES Monomando de lavabo



FALA

No.	Series / Seria	
75760	Soria	10

EN Single-lever shower mixer
 PL Bateria prysznicowa
 DE Einhand-Brausebatterie
 RU Смеситель для душа
 CS Sprchová baterie
 RO Baterie dus
 HU Egykaros zuhanycsaptelep
 ES Monomando de ducha



FALA

No.	Series / Seria	
75763	Soria	10

EN Basin mixer
 PL Bateria umywalkowa
 DE Einhand-Waschtischbatterie
 RU Смеситель для раковины
 CS Umyvadlová baterie
 RO Baterie lavoar
 HU Mosdó csaptelep
 ES Monomando de lavabo



FALA

No.	Series / Seria	
75765	Murcia	10

EN Bath mixer
 PL Bateria wannowa
 DE Einhand-Wannenbatterie
 RU Смеситель для ванны
 CS Vanové baterie
 RO Baterie cada / dus
 HU Egykaros kádcsaptelep
 ES Monomando para baño

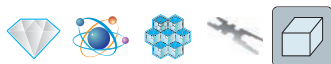

FALA

No.	Series / Seria	Box
75767	Murcia	8

EN Single-lever shower mixer
 PL Bateria prysznicowa
 DE Einhand-Brausebatterie
 RU Смеситель для душа
 CS Sprchová baterie
 RO Baterie dus
 HU Egykaros zuhanycsaptelep
 ES Monomando de ducha



FALA

No.	Series / Seria	Box
75768	Murcia	10

EN Basin mixer
 PL Bateria umywalkowa
 DE Einhand-Waschtischbatterie
 RU Смеситель для раковины
 CS Umyvadlová baterie
 RO Baterie lavoar
 HU Mosdó csaptelep
 ES Monomando de lavabo



FALA

No.	Series / Seria	Box
75745	Burgos	10

EN Bath mixer
 PL Bateria wannowa
 DE Einhand-Wannenbatterie
 RU Смеситель для ванны
 CS Vanové baterie
 RO Baterie cada / dus
 HU Egykaros kádcsaptelep
 ES Monomando para baño

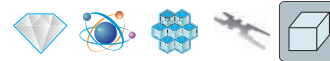

FALA

No.	Series / Seria	Box
75747	Burgos	8

EN Single-lever shower mixer
 PL Bateria prysznicowa
 DE Einhand-Brausebatterie
 RU Смеситель для душа
 CS Sprchová baterie
 RO Baterie dus
 HU Egykaros zuhanycsaptelep
 ES Monomando de ducha



EN Single-lever sink mixer
 PL Bateria zlewozmywakowa
 DE Einhand-Spültischbatterie
 RU Смеситель для кухни
 CS Dřezová baterie
 RO Baterie stativă bucatărie
 HU Mosogató csaptelep
 ES Monomando de fregadero



FALA

No.	Series / Seria	Box
75749	Burgos	8

EN Basin mixer
 PL Bateria umywalkowa
 DE Einhand-Waschtischbatterie
 RU Смеситель для раковины
 CS Umyvadlová baterie
 RO Baterie lavoar
 HU Mosdó csaptelep
 ES Monomando de lavabo



FALA

No.	Series / Seria	
75880	Noir 1	12

EN Bath mixer
 PL Bateria wannowa
 DE Einhand-Wannenbatterie
 RU Смеситель для ванны
 CS Vanové baterie
 RO Baterie cada / dus
 HU Egykaros kádcsaptelep
 ES Monomando para bañu



FALA

No.	Series / Seria	
75882	Noir 1	8

EN Single-lever sink mixer
 PL Bateria zlewozmywakowa
 DE Einhand-Spültischbatterie
 RU Смеситель для кухни
 CS Dřezová baterie
 RO Baterie stativă bucatărie
 HU Mosogató csaptelep
 ES Monomando de fregadero

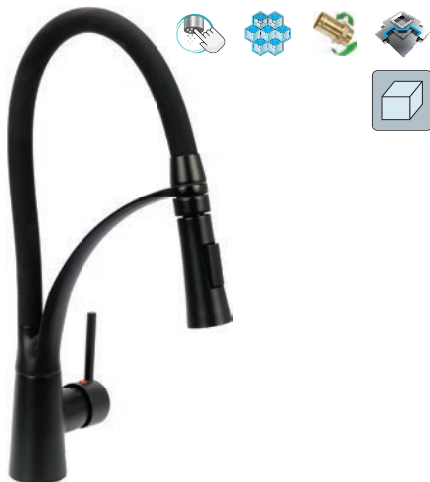

FALA

No.	Series / Seria	
75884	Noir 1	12

EN Basin mixer
 PL Bateria umywalkowa
 DE Einhand-Waschtischbatterie
 RU Смеситель для раковины
 CS Umyvadlová baterie
 RO Baterie lavoar
 HU Mosdó csaptelep
 ES Monomando de lavabo



FALA

No.	Series / Seria	
75881	Noir 1	12

EN Shower column
 PL Kolumna prysznicowa
 DE Duschsäule
 RU Душевая штанга
 CS Sprchový sloup
 RO Coloană de duș
 HU Zuhanyoszlop
 ES Columna de ducha



FALA

No.	Series / Seria	
75883	Noir 1	4

EN Basin mixer
 PL Bateria umywalkowa
 DE Einhand-Waschtischbatterie
 RU Смеситель для раковины
 CS Umyvadlová baterie
 RO Baterie lavoar
 HU Mosdó csaptelep
 ES Monomando de lavabo



FALA

No.	Series / Seria	
75885	Noir 2	12

EN Basin mixer
 PL Bateria umywalkowa
 DE Einhand-Waschtischbatterie
 RU Смеситель для раковины
 CS Umyvadlová baterie
 RO Baterie lavabo
 HU Mosdó csaptelep
 ES Monomando de lavabo



FALA

No.	Series / Seria	
75886	Noir 2	12

EN Bath mixer
 PL Bateria wannowa
 DE Einhand-Wannenbatterie
 RU Смеситель для ванны
 CS Vanové baterie
 RO Baterie cada / dus
 HU Egykaros kádcsaptelep
 ES Monomando para baño



FALA

No.	Series / Seria	
75888	Noir 2	8

EN Single-lever sink mixer
 PL Bateria zlewozmywakowa
 DE Einhand-Spültischbatterie
 RU Смеситель для кухни
 CS Dřezová baterie
 RO Baterie stativă bucatărie
 HU Mosogató csaptelep
 ES Monomando de fregadero



FALA

No.	Series / Seria	
75705	Flexible-Black	10

EN Single-lever shower mixer
 PL Bateria prysznicowa
 DE Einhand-Brausebatterie
 RU Смеситель для душа
 CS Sprchová baterie
 RO Baterie dus
 HU Egykaros zuhanycsaptelep
 ES Monomando de ducha



FALA

No.	Series / Seria	
75887	Noir 2	8

EN Shower column
 PL Kolumna prysznicowa
 DE Duschsäule
 RU Душевая штанга
 CS Sprchový sloup
 RO Coloană de duș
 HU Zuhanyoszlop
 ES Columna de ducha



FALA

No.	Series / Seria	
75889	Noir 2	4

EN Single-lever sink mixer
 PL Bateria zlewozmywakowa
 DE Einhand-Spültischbatterie
 RU Смеситель для кухни
 CS Dřezová baterie
 RO Baterie stativă bucatărie
 HU Mosogató csaptelep
 ES Monomando de fregadero



FALA

No.	Series / Seria	
75706	Flexible-White	10

EN Single-lever sink mixer
 PL Bateria zlewozmywakowa
 DE Einhand-Spültischbatterie
 RU Смеситель для кухни
 CS Dřezová baterie
 RO Baterie stativă bucatărie
 HU Mosogató csaptelep
 ES Monomando de fregadero



FALA

No.	Series / Seria	
75707	Flexible-Red	10

EN Single-lever sink mixer
 PL Bateria zlewozmywakowa
 DE Einhand-Spültischbatterie
 RU Смеситель для кухни
 CS Dřezová baterie
 RO Baterie stativă bucatărie
 HU Mosogató csaptelep
 ES Monomando de fregadero



FALA

No.	Series / Seria	
75708	Flexible-Orange	10

EN Single-lever sink mixer
 PL Bateria zlewozmywakowa
 DE Einhand-Spültischbatterie
 RU Смеситель для кухни
 CS Dřezová baterie
 RO Baterie stativă bucatărie
 HU Mosogató csaptelep
 ES Monomando de fregadero



FALA

No.	Series / Seria	
75709	Flexible-Green	10

EN Single-lever sink mixer
 PL Bateria zlewozmywakowa
 DE Einhand-Spültischbatterie
 RU Смеситель для кухни
 CS Dřezová baterie
 RO Baterie stativă bucatărie
 HU Mosogató csaptelep
 ES Monomando de fregadero



FALA

No.	Series / Seria	
75710	Flexible-Light Grey	10

EN Single-lever sink mixer
 PL Bateria zlewozmywakowa
 DE Einhand-Spültischbatterie
 RU Смеситель для кухни
 CS Dřezová baterie
 RO Baterie stativă bucatărie
 HU Mosogató csaptelep
 ES Monomando de fregadero



FALA

No.	Series / Seria	
75711	Flexible-Dark Grey	10

EN Single-lever sink mixer
 PL Bateria zlewozmywakowa
 DE Einhand-Spültischbatterie
 RU Смеситель для кухни
 CS Dřezová baterie
 RO Baterie stativă bucatărie
 HU Mosogató csaptelep
 ES Monomando de fregadero



FALA

No.	Series / Seria	
75712	Flexible-Brown	10

EN Single-lever sink mixer
 PL Bateria zlewozmywakowa
 DE Einhand-Spültischbatterie
 RU Смеситель для кухни
 CS Dřezová baterie
 RO Baterie stativă bucatărie
 HU Mosogató csaptelep
 ES Monomando de fregadero



FALA

No.	Series / Seria	Box
75729	Flexible-Steely Black	10

EN Single-lever sink mixer
 PL Bateria zlewozmywakowa
 DE Einhand-Spültischbatterie
 RU Смеситель для кухни
 CS Dřezová baterie
 RO Baterie stativă bucatărie
 HU Mosogató csaptelep
 ES Monomando de fregadero



FALA

No.	Series / Seria	Box
75776	Black Flexible-White	20

EN Single-lever sink mixer
 PL Bateria zlewozmywakowa
 DE Einhand-Spültischbatterie
 RU Смеситель для кухни
 CS Dřezová baterie
 RO Baterie stativă bucatărie
 HU Mosogató csaptelep
 ES Monomando de fregadero



FALA

No.	Series / Seria	Box
75778	Black Flexible-Orange	10

EN Single-lever sink mixer
 PL Bateria zlewozmywakowa
 DE Einhand-Spültischbatterie
 RU Смеситель для кухни
 CS Dřezová baterie
 RO Baterie stativă bucatărie
 HU Mosogató csaptelep
 ES Monomando de fregadero



FALA

No.	Series / Seria	Box
75775	Black Flexible-Black	10

EN Single-lever sink mixer
 PL Bateria zlewozmywakowa
 DE Einhand-Spültischbatterie
 RU Смеситель для кухни
 CS Dřezová baterie
 RO Baterie stativă bucatărie
 HU Mosogató csaptelep
 ES Monomando de fregadero



FALA

No.	Series / Seria	Box
75777	Black Flexible-Red	10

EN Single-lever sink mixer
 PL Bateria zlewozmywakowa
 DE Einhand-Spültischbatterie
 RU Смеситель для кухни
 CS Dřezová baterie
 RO Baterie stativă bucatărie
 HU Mosogató csaptelep
 ES Monomando de fregadero



FALA

No.	Series / Seria	Box
75779	Black Flexible-Green	10

EN Single-lever sink mixer
 PL Bateria zlewozmywakowa
 DE Einhand-Spültischbatterie
 RU Смеситель для кухни
 CS Dřezová baterie
 RO Baterie stativă bucatărie
 HU Mosogató csaptelep
 ES Monomando de fregadero



FALA

No.	Series / Seria	Box
75675	Flexible 2 Black	10

EN Single-lever sink mixer
 PL Bateria zlewozmywakowa
 DE Einhand-Spültischbatterie
 RU Смеситель для кухни
 CS Dřezová baterie
 RO Baterie stativă bucatărie
 HU Mosogató csaptelep
 ES Monomando de fregadero

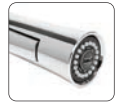

FALA

No.	Series / Seria	Box
75676	Flexible 2 White	10

EN Single-lever sink mixer
 PL Bateria zlewozmywakowa
 DE Einhand-Spültischbatterie
 RU Смеситель для кухни
 CS Dřezová baterie
 RO Baterie stativă bucatărie
 HU Mosogató csaptelep
 ES Monomando de fregadero



FALA

No.	Series / Seria	Box
75677	Flexible 2 Red	10

EN Single-lever sink mixer
 PL Bateria zlewozmywakowa
 DE Einhand-Spültischbatterie
 RU Смеситель для кухни
 CS Dřezová baterie
 RO Baterie stativă bucatărie
 HU Mosogató csaptelep
 ES Monomando de fregadero



FALA

No.	Series / Seria	Box
75678	Flexible 2 Orange	10

EN Single-lever sink mixer
 PL Bateria zlewozmywakowa
 DE Einhand-Spültischbatterie
 RU Смеситель для кухни
 CS Dřezová baterie
 RO Baterie stativă bucatărie
 HU Mosogató csaptelep
 ES Monomando de fregadero



FALA

No.	Series / Seria	Box
75679	Flexible 2 Green	10

EN Single-lever sink mixer
 PL Bateria zlewozmywakowa ścienna
 DE Einhand-Spültischbatterie
 RU Смеситель для кухни
 CS Dřezová baterie
 RO Baterie bucatărie
 HU Mosogató csaptelep
 ES Monomando de fregadero



FALA

No.	Series / Seria	Box
75670	Flexible-Black	10

EN Single-lever sink mixer
 PL Bateria zlewozmywakowa ścienna
 DE Einhand-Spültischbatterie
 RU Смеситель для кухни
 CS Dřezová baterie
 RO Baterie bucătărie
 HU Mosogató csaptelep
 ES Monomando de fregadero



FALA

No.	Series / Seria	
75671	Flexible-White	10

EN Single-lever sink mixer
 PL Bateria zlewozmywakowa ścienna
 DE Einhand-Spültischbatterie
 RU Смеситель для кухни
 CS Dřezová baterie
 RO Baterie bucătărie
 HU Mosogató csaptelep
 ES Monomando de fregadero



FALA

No.	Series / Seria	
75673	Flexible-Orange	10

EN Pop-up waste
 PL Korek z sitkiem
 DE Waschbecken Stöpsel
 RU Пробка
 CS Zátka
 RO Sifon chiuveta
 HU Mosdo lefolyó elzáró
 ES Tapón



FALA

No.		
74780		240

EN Single-lever sink mixer
 PL Bateria zlewozmywakowa ścienna
 DE Einhand-Spültischbatterie
 RU Смеситель для кухни
 CS Dřezová baterie
 RO Baterie bucătărie
 HU Mosogató csaptelep
 ES Monomando de fregadero



FALA

No.	Series / Seria	
75672	Flexible-Red	10

EN Single-lever sink mixer
 PL Bateria zlewozmywakowa ścienna
 DE Einhand-Spültischbatterie
 RU Смеситель для кухни
 CS Dřezová baterie
 RO Baterie bucătărie
 HU Mosogató csaptelep
 ES Monomando de fregadero



FALA

No.	Series / Seria	
75674	Flexible-Green	10

EN Pop-up waste
 PL Korek z sitkiem
 DE Waschbecken Stöpsel
 RU Пробка
 CS Zátka
 RO Sifon chiuveta
 HU Mosdo lefolyó elzáró
 ES Tapón



FALA

No.		
74781		240

EN Pop-up waste
 PL Korek z sitkiem
 DE Waschbecken Stöpsel
 RU Пробка
 CS Zátka
 RO Sifon chiuveta
 HU Mosdo lefolyó elzaro
 ES Tapón



FALA

No.

74782



240

EN Pop-up waste
 PL Korek z sitkiem
 DE Waschbecken Stöpsel
 RU Пробка
 CS Zátka
 RO Sifon chiuveta
 HU Mosdo lefolyó elzaro
 ES Tapón



FALA

No.

74783



240

EN Pop-up waste
 PL Korek z sitkiem
 DE Waschbecken Stöpsel
 RU Пробка
 CS Zátka
 RO Sifon chiuveta
 HU Mosdo lefolyó elzaro
 ES Tapón



FALA

No.

74784



240

EN Organizer
 PL Organizer
 DE Organizer
 RU Органайзер
 CS Organizér
 RO Organizator
 HU Szervező
 ES Organizador



FALA

No.

74785



144

EN Organizer
 PL Organizer
 DE Organizer
 RU Органайзер
 CS Organizér
 RO Organizator
 HU Szervező
 ES Organizador



FALA

No.

74786



144

EN Organizer
 PL Organizer
 DE Organizer
 RU Органайзер
 CS Organizér
 RO Organizator
 HU Szervező
 ES Organizador



FALA

No.

74787



144

EN Organizer
 PL Organizer
 DE Organizer
 RU Органайзер
 CS Organizér
 RO Organizator
 HU Szervező
 ES Organizador



FALA

No.

74788



144

EN Organizer
 PL Organizer
 DE Organizer
 RU Органайзер
 CS Organizér
 RO Organizator
 HU Szervező
 ES Organizador



FALA

No.

74789



144

EN Mat
 PL Mała
 DE Matte
 RU Коврик
 CS Podložka
 RO Mat
 HU Lábtörő
 ES Alfombra



FALA

No.	
74790	50/200

EN Mat
 PL Mała
 DE Matte
 RU Коврик
 CS Podložka
 RO Mat
 HU Lábtörő
 ES Alfombra



FALA

No.	
74792	50/200

EN Mat
 PL Mała
 DE Matte
 RU Коврик
 CS Podložka
 RO Mat
 HU Lábtörő
 ES Alfombra



FALA

No.	
74794	50/200

EN Soap dispenser
 PL Dozownik mydła w płynie
 DE Seifenspender
 RU Дозатор для мыла
 CS Dávkovač mýdla
 RO Dozator sapun lichid
 HU Folyékonyszappan adagoló
 ES Dispensador de jabón



FALA

No.	
69396	100

EN Mat
 PL Mała
 DE Matte
 RU Коврик
 CS Podložka
 RO Mat
 HU Lábtörő
 ES Alfombra



FALA

No.	
74791	50/200

EN Mat
 PL Mała
 DE Matte
 RU Коврик
 CS Podložka
 RO Mat
 HU Lábtörő
 ES Alfombra



FALA

No.	
74793	50/200

EN Soap dispenser
 PL Dozownik mydła w płynie
 DE Seifenspender
 RU Дозатор для мыла
 CS Dávkovač mýdla
 RO Dozator sapun lichid
 HU Folyékonyszappan adagoló
 ES Dispensador de jabón



FALA

No.	
69395	100

EN Soap dispenser
 PL Dozownik mydła w płynie
 DE Seifenspender
 RU Дозатор для мыла
 CS Dávkovač mýdla
 RO Dozator sapun lichid
 HU Folyékonyszappan adagoló
 ES Dispensador de jabón



FALA

No.	
69397	100

EN Soap dispenser
 PL Dozownik mydła w płynie
 DE Seifenspender
 RU Дозатор для мыла
 CS Dávkovač mýdla
 RO Dozator sapun lichid
 HU Folyékonyszappan adagoló
 ES Dispensador de jabón



FALA

No.	
69390	60

EN Soap dispenser
 PL Dozownik mydła w płynie
 DE Seifenspender
 RU Дозатор для мыла

CS Dávkovač mýdla
 RO Dozator sapun lichid
 HU Folyékonyszappan adagoló
 ES Dispensador de jabón



FALA

No.	
69391	24

<p>Special inspection window for 100% outflow control and comfortable cleaning.</p> <p>Specjalne okienko rewizyjne to 100% kontroli drożności i wygodne czyszczenie.</p>  <p>SMARTthru</p>	<p>Easy to clean thanks to contained hook.</p> <p>Łatwy do utrzymania w czystości dzięki dołączonemu haczykowi.</p>  <p>EASYclean</p>	<p>Stabilizing body grips, additional stiffening in the floor.</p> <p>Uchwyty stabilizujące korpus. Dodatkowo usztywnienie konstrukcji w podłodze.</p>  <p>GRIPstrong</p>
<p>Waterproof cloth included – as essential part of waterproofing.</p> <p>Mata uszczelniająca w zestawie – niezbędna część przy wykonywaniu hydroizolacji.</p>  <p>HYDRCloth</p>	<p>Effective and durable strainer which prevents clogging of the trap and makes cleaning easier.</p> <p>Skuteczne i trwałe sito, które zapobiega zapychaniu syfonu oraz ułatwia bieżącą obsługę odpływu.</p>  <p>STRAINER</p>	<p>High quality precision welds guarantee no leaking of the drain.</p> <p>Wysokiej jakości precyzyjne spawy gwarantujące szczelność odpływu.</p>  <p>HQwelding</p>
<p>Low siphon made of stainless steel AISI 304 makes installation easier.</p> <p>Niski syfon wykonany ze stali nierdzewnej AISI 304 ułatwiający instalację.</p>  <p>EXTRASlim</p>	<p>Wide range of height adjustment allows adjusting to the floor level.</p> <p>Szeroki zakres regulacji wysokości, który umożliwia dopasowanie odpływu do powierzchni posadzki.</p>  <p>EASYfix</p>	<p>It can prevent stink and worms both in use and after dry (no water in siphon).</p> <p>Zapobiega przedostawaniu się zapachów oraz robaków podczas używania jak i po wysuszeniu (brak wody w syfonie).</p>  <p>WET&DRY</p>

EN Linear drain
 PL Odpływ liniowy
 DE Duschrinne
 RU Душевой лоток
 CS Odtokový žlab
 RO Rigola dus
 HU Zuhanyfolyóka
 ES Canal de ducha



FALA

No.	Body length / Długość rynny [mm]	Series / Seria	
75345	500	Rotary	5
75346	600	Rotary	5
75347	700	Rotary	5
75348	800	Rotary	5
75349	900	Rotary	5

EN Linear drain
 PL Odpływ liniowy
 DE Duschrinne
 RU Душевой лоток
 CS Odtokový žlab
 RO Rigola dus
 HU Zuhanyfolyóka
 ES Canal de ducha



FALA

No.	Body length / Długość rynny [mm]	Series / Seria	
75350	300	Brick	5
75351	400	Brick	5
75352	500	Brick	5
75353	600	Brick	5
75354	700	Brick	5
75355	800	Brick	5
75356	900	Brick	5

EN Linear drain
 PL Odpływ liniowy
 DE Duschrinne
 RU Душевой лоток
 CS Odtokový žlab
 RO Rigola dus
 HU Zuhanyfolyóka
 ES Canal de ducha



FALA

No.	Body length / Długość rynny [mm]	Series / Seria	
75360	300	Madeira	6
75361	400	Madeira	6
75362	500	Madeira	6

EN Linear drain
 PL Odpływ liniowy
 DE Duschrinne
 RU Душевой лоток
 CS Odtokový žlab
 RO Rigola dus
 HU Zuhanyfolyóka
 ES Canal de ducha



FALA

No.	Body length / Długość rynny [mm]	Series / Seria	
75367	300	Tocantins	6
75368	400	Tocantins	6
75369	500	Tocantins	6

EN Linear drain
 PL Odpływ liniowy
 DE Duschrinne
 RU Душевой лоток
 CS Odtokový žlab
 RO Rigola dus
 HU Zuhanyfolyóka
 ES Canal de ducha



FALA

No.	Body length / Długość rynny [mm]	Series / Seria	
75374	300	Napo	6
75375	400	Napo	6
75376	500	Napo	6

EN Linear drain
 PL Odpływ liniowy
 DE Duschrinne
 RU Душевой лоток
 CS Odtokový žlab
 RO Rigola dus
 HU Zuhanyfolyóka
 ES Canal de ducha



FALA

No.	Body length / Długość rynny [mm]	Series / Seria	
75363	600	Madeira	6
75364	700	Madeira	6
75365	800	Madeira	6
75366	800	Madeira	6

EN Linear drain
 PL Odpływ liniowy
 DE Duschrinne
 RU Душевой лоток
 CS Odtokový žlab
 RO Rigola dus
 HU Zuhanyfolyóka
 ES Canal de ducha



FALA

No.	Body length / Długość rynny [mm]	Series / Seria	
75370	600	Tocantins	6
75371	700	Tocantins	6
75372	800	Tocantins	6
75373	900	Tocantins	6

EN Linear drain
 PL Odpływ liniowy
 DE Duschrinne
 RU Душевой лоток
 CS Odtokový žlab
 RO Rigola dus
 HU Zuhanyfolyóka
 ES Canal de ducha



FALA

No.	Body length / Długość rynny [mm]	Series / Seria	
75377	600	Napo	6
75378	700	Napo	6
75379	800	Napo	6
75380	900	Napo	6

EN Linear drain
PL Odpływ liniowy
DE Duschrinne
RU Душевой лоток
CS Odtokový žlab
RO Rigola dus
HU Zuhanyfolyóka
ES Canal de ducha



FALA

No.	Body length / Długość rynny [mm]	Series / Seria	
75381	600	White Glass	6
75382	700	White Glass	6
75383	800	White Glass	6
75384	900	White Glass	6

EN Linear drain
PL Odpływ liniowy
DE Duschrinne
RU Душевой лоток
CS Odtokový žlab
RO Rigola dus
HU Zuhanyfolyóka
ES Canal de ducha



FALA

No.	Body length / Długość rynny [mm]	Series / Seria	
75421	600	Olimp	6
75422	700	Olimp	6
75423	800	Olimp	6
75424	900	Olimp	6

EN Linear drain
PL Odpływ liniowy
DE Duschrinne
RU Душевой лоток
CS Odtokový žlab
RO Rigola dus
HU Zuhanyfolyóka
ES Canal de ducha

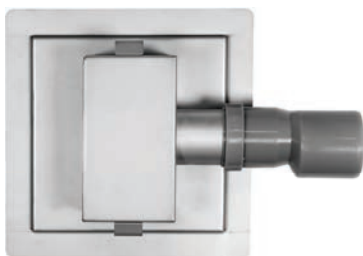

FALA

No.	Body size / Rozmiar rynny [mm]	Series / Seria	
75334	150x150	Quad	10
75335	200x200	Quad	10
75336	250x250	Quad	10

EN Linear drain
PL Odpływ liniowy
DE Duschrinne
RU Душевой лоток
CS Odtokový žlab
RO Rigola dus
HU Zuhanyfolyóka
ES Canal de ducha



FALA

No.	Body length / Długość rynny [mm]	Series / Seria	
75386	600	Black Glass	6
75387	700	Black Glass	6
75388	800	Black Glass	6
75389	900	Black Glass	6

EN Linear drain
PL Odpływ liniowy
DE Duschrinne
RU Душевой лоток
CS Odtokový žlab
RO Rigola dus
HU Zuhanyfolyóka
ES Canal de ducha



FALA

No.	Body length / Długość rynny [mm]	Series / Seria	
75448	600	Line	6
75449	700	Line	6
75450	800	Line	6
75451	900	Line	6

EN Aerator and sealing set for sanitary mixers
PL Perlator i zestaw uszczeltek do baterii
DE Strahlregler- und Dichtungsgummissatz für Armatur
RU Аэратор с набором прокладок для смесителя
CS Perlator a sada těsnění do baterie
RO Sita si garnituri pt. baterii sanitare
HU Levegőtető és tömítőgumi készlet csaptelephez
ES Aireado y juego de juntas



FALA

No.	
75327	25/200

- EN Pop-up waste
- PL Korek do umywalki
- DE Waschbecken Stöpsel
- RU Автоматическая пробка
- CS Automatická zátka
- RO Sifon chiuveta
- HU Mosdo lefolyo elzaro
- ES Tapón automat. para bateria de lado



FALA

No.	
75498	12/48

- EN Pop-up waste
- PL Korek automatyczny
- DE Waschbecken Stöpsel
- RU Автоматическая пробка для умывальника
- CS Automatická zátka
- RO Sifon chiuveta
- HU Mosdo lefolyo elzaro
- ES Tapón automat. para bateria de lado



FALA

No.	
75483	48/96

- EN Pop-up waste
- PL Korek automatyczny
- DE Waschbecken Stöpsel
- RU Автоматическая пробка для умывальника
- CS Automatická zátka
- RO Sifon chiuveta
- HU Mosdo lefolyo elzaro
- ES Tapón automat. para bateria de lado



FALA

No.	
75487	20/40

- EN Pop-up waste
- PL Korek do umywalki
- DE Waschbecken Stöpsel
- RU Автоматическая пробка
- CS Automatická zátka
- RO Sifon chiuveta
- HU Mosdo lefolyo elzaro
- ES Tapón automat. para bateria de lado



FALA

No.	
75499	12/48

- EN Pop-up waste
- PL Korek automatyczny
- DE Waschbecken Stöpsel
- RU Автоматическая пробка для умывальника
- CS Automatická zátka
- RO Sifon chiuveta
- HU Mosdo lefolyo elzaro
- ES Tapón automat. para bateria de lado



FALA

No.	
75484	20/40

- EN Shower handle
- PL Sluchawka prysznicowa
- DE Handbrause
- RU Разбрызгиватель для душа
- CS Ruční sprcha
- RO Cap duș
- HU Kézi zuhanyfej
- ES Ducha



FALA

No.	
75540	20/80

EN Shower handle
 PL Słuchawka prysznicowa
 DE Handbrause
 RU Разбрызгиватель для душа
 CS Ruční sprcha
 RO Cap duș
 HU Kézi zuhanyfej
 ES Ducha



FALA

No.	
75541	20/80

EN Shower handle
 PL Słuchawka prysznicowa
 DE Handbrause
 RU Разбрызгиватель для душа
 CS Ruční sprcha
 RO Cap duș
 HU Kézi zuhanyfej
 ES Ducha

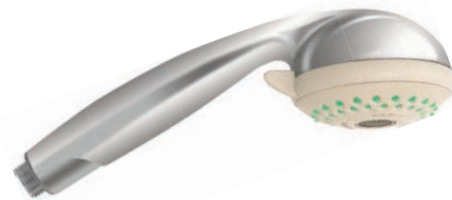

FALA

No.	
75545	15/60

EN Shower handle
 PL Słuchawka prysznicowa
 DE Handbrause
 RU Разбрызгиватель для душа
 CS Ruční sprcha
 RO Cap duș
 HU Kézi zuhanyfej
 ES Ducha



FALA

No.	
75550	30/60

EN Shower handle
 PL Słuchawka prysznicowa
 DE Handbrause
 RU Разбрызгиватель для душа
 CS Ruční sprcha
 RO Cap duș
 HU Kézi zuhanyfej
 ES Ducha



FALA

No.	Series / Seria	
75627	Delta	24/48

EN Shower handle
 PL Słuchawka prysznicowa
 DE Handbrause
 RU Разбрызгиватель для душа
 CS Ruční sprcha
 RO Cap duș
 HU Kézi zuhanyfej
 ES Ducha



FALA

No.	
75544	15/60

EN Shower handle
 PL Słuchawka prysznicowa
 DE Handbrause
 RU Разбрызгиватель для душа
 CS Ruční sprcha
 RO Cap duș
 HU Kézi zuhanyfej
 ES Ducha



FALA

No.	
75551	30/60

EN Shower handle
 PL Słuchawka prysznicowa
 DE Handbrause
 RU Разбрызгиватель для душа
 CS Ruční sprcha
 RO Cap duș
 HU Kézi zuhanyfej
 ES Ducha



FALA

No.	Series / Seria	
75629	Tugela	24/48

EN Shower handle
 PL Słuchawka prysznicowa
 DE Handbrause
 RU Разбрызгиватель для душа
 CS Ruční sprcha
 RO Cap duș
 HU Kézi zuhanyfej
 ES Ducha



FALA

No.	Series / Seria	Box
75631	Hermana	25/50

EN Shower handle
 PL Słuchawka prysznicowa
 DE Handbrause
 RU Разбрызгиватель для душа
 CS Ruční sprcha
 RO Cap duș
 HU Kézi zuhanyfej
 ES Ducha



FALA

No.	Series / Seria	Box
75625	Detifos	25/50

EN Shower handle
 PL Słuchawka prysznicowa
 DE Handbrause
 RU Разбрызгиватель для душа
 CS Ruční sprcha
 RO Cap duș
 HU Kézi zuhanyfej
 ES Ducha



FALA

No.	Series / Seria	Box
75632	Fobos	12

EN Shower handle
 PL Słuchawka prysznicowa
 DE Handbrause
 RU Разбрызгиватель для душа
 CS Ruční sprcha
 RO Cap duș
 HU Kézi zuhanyfej
 ES Ducha



FALA

No.	Series / Seria	Box
75634	Dione	12



EN Shower handle
 PL Słuchawka prysznicowa
 DE Handbrause
 RU Разбрызгиватель для душа
 CS Ruční sprcha
 RO Cap duș
 HU Kézi zuhanyfej
 ES Ducha



FALA

No.	Series / Seria	Box
75626	Kile	25/50

EN Shower handle
 PL Słuchawka prysznicowa
 DE Handbrause
 RU Разбрызгиватель для душа
 CS Ruční sprcha
 RO Cap duș
 HU Kézi zuhanyfej
 ES Ducha



FALA

No.	Series / Seria	Box
75628	Deimos	12

EN Shower handle
 PL Słuchawka prysznicowa
 DE Handbrause
 RU Разбрызгиватель для душа
 CS Ruční sprcha
 RO Cap duș
 HU Kézi zuhanyfej
 ES Ducha



FALA

No.	Series / Seria	Box
75633	Japet	12

EN Shower handle
 PL Słuchawka prysznicowa
 DE Handbrause
 RU Разбрызгиватель для душа
 CS Ruční sprcha
 RO Cap duș
 HU Kézi zuhanyfej
 ES Ducha



FALA

No.	Series / Seria	Box
75635	Mimas	12



GB Shower handle
 PL Sluchawka prysznicowa
 DE Handbrause
 RU Разбрызгиватель для душа
 CZ Ruční sprcha
 RO Cap duș
 HU Kézi zuhanyfej
 ES Ducha



FALA

No.	Series / Seria	Box
75636	Silver Moon	12

EN Shower handle
 PL Sluchawka prysznicowa
 DE Handbrause
 RU Разбрызгиватель для душа
 CS Ruční sprcha
 RO Cap duș
 HU Kézi zuhanyfej
 ES Ducha



FALA

No.	Series / Seria	Box
75624	Salto	25/50

EN Shower handle
 PL Sluchawka prysznicowa
 DE Handbrause
 RU Разбрызгиватель для душа
 CS Ruční sprcha
 RO Cap duș
 HU Kézi zuhanyfej
 ES Ducha



FALA

No.	Series / Seria	Box
75620	Salto	25/50

EN Shower handle
 PL Sluchawka prysznicowa
 DE Handbrause
 RU Разбрызгиватель для душа
 CS Ruční sprcha
 RO Cap duș
 HU Kézi zuhanyfej
 ES Ducha



FALA

No.	Series / Seria	Box
75622	Salto	25/50

EN Shower handle
 PL Sluchawka prysznicowa
 DE Handbrause
 RU Разбрызгиватель для душа
 CS Ruční sprcha
 RO Cap duș
 HU Kézi zuhanyfej
 ES Ducha



FALA

No.	Series / Seria	Box
75639	White Moon	12

EN Shower handle
 PL Sluchawka prysznicowa
 DE Handbrause
 RU Разбрызгиватель для душа
 CS Ruční sprcha
 RO Cap duș
 HU Kézi zuhanyfej
 ES Ducha



FALA

No.	Series / Seria	Box
75619	Salto	25/50

EN Shower handle
 PL Sluchawka prysznicowa
 DE Handbrause
 RU Разбрызгиватель для душа
 CS Ruční sprcha
 RO Cap duș
 HU Kézi zuhanyfej
 ES Ducha



FALA

No.	Series / Seria	Box
75621	Salto	25/50

EN Shower handle
 PL Sluchawka prysznicowa
 DE Handbrause
 RU Разбрызгиватель для душа
 CS Ruční sprcha
 RO Cap duș
 HU Kézi zuhanyfej
 ES Ducha



FALA

No.	Series / Seria	Box
75623	Salto	25/50

EN Shower holder
 PL Uchwyt do słuchawki prysznicowej
 DE Brauseporter
 RU Держатель душ
 CS Držák s kloubem na sprchu
 RO Suport pt. dus
 HU Zuhanycső tartó
 ES Grifo para ducha



FALA

No.	
75527	100

EN Shower holder
 PL Uchwyt do słuchawki prysznicowej
 DE Brauseporter
 RU Держатель душ
 CS Držák s kloubem na sprchu
 RO Suport pt. dus
 HU Zuhanycső tartó
 ES Grifo para ducha



FALA

No.	
75535	100

EN Shower holder
 PL Uchwyt do słuchawki prysznicowej
 DE Brauseporter
 RU Держатель душ
 CS Držák s kloubem na sprchu
 RO Suport pt. dus
 HU Zuhanycső tartó
 ES Grifo para ducha



FALA

No.	
75536	100

EN Shower holder
 PL Uchwyt do słuchawki prysznicowej
 DE Brauseporter
 RU Держатель душ
 CS Držák s kloubem na sprchu
 RO Suport pt. dus
 HU Zuhanycső tartó
 ES Grifo para ducha



FALA

No.	
75537	100

EN Shower holder
 PL Uchwyt do słuchawki prysznicowej
 DE Brauseporter
 RU Держатель душ
 CS Držák s kloubem na sprchu
 RO Suport pt. dus
 HU Zuhanycső tartó
 ES Grifo para ducha

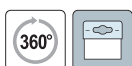

FALA

No.	
75539	100

EN Shower holder
 PL Uchwyt do słuchawki prysznicowej
 DE Brauseporter
 RU Держатель душ
 CS Držák s kloubem na sprchu
 RO Suport pt. dus
 HU Zuhanycső tartó
 ES Grifo para ducha



FALA

No.	
75564	50/200

EN Shower holder
 PL Uchwyt do słuchawki prysznicowej
 DE Brauseporter
 RU Держатель душ
 CS Držák s kloubem na sprchu
 RO Suport pt. dus
 HU Zuhanycső tartó
 ES Grifo para ducha



FALA

No.	
75565	30/180



EN Shower hose
 PL Wąż prysznicowy
 DE Brausenschlauch
 RU Шланг для душа
 CS Sprchová hadice
 RO Furtun duș
 HU Zuhanycső
 ES Manguera de ducha



FALA

No.	L [m]	Box
75553	1.5	30/60
75554	1.7	30/60

EN Shower hose
 PL Wąż prysznicowy
 DE Brausenschlauch
 RU Шланг для душа
 CS Sprchová hadice
 RO Furtun duș
 HU Zuhanycső
 ES Manguera de ducha



FALA

No.	L [m]	Box
75578	1.5	30/60
75579	1.7	30/60

EN Shower hose
 PL Wąż prysznicowy
 DE Brausenschlauch
 RU Шланг для душа
 CS Sprchová hadice
 RO Furtun duș
 HU Zuhanycső
 ES Manguera de ducha

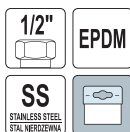

FALA

No.	L [m]	Box
75650	1.25-1.75	50

EN Shower hose
 PL Wąż prysznicowy
 DE Brausenschlauch
 RU Шланг для душа
 CS Sprchová hadice
 RO Furtun duș
 HU Zuhanycső
 ES Manguera de ducha



FALA

No.	L [m]	Box
75648	1.5	50
75649	2.0	50

EN Shower hose
 PL Wąż prysznicowy
 DE Brausenschlauch
 RU Шланг для душа
 CS Sprchová hadice
 RO Furtun duș
 HU Zuhanycső
 ES Manguera de ducha

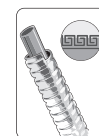

FALA

No.	L [m]	Box
75645	1.50	50
75646	1.75	50
75647	2.00	50

EN Shower hose
 PL Wąż prysznicowy
 DE Brausenschlauch
 RU Шланг для душа
 CS Sprchová hadice
 RO Furtun duș
 HU Zuhanycső
 ES Manguera de ducha

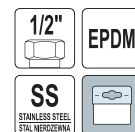

FALA

No.	L [m]	Box
75651	1.5-2.0	50

EN Shower hose
 PL Wąż prysznicowy
 DE Brausenschlauch
 RU Шланг для душа
 CS Sprchová hadice
 RO Furtun duș
 HU Zuhanycső
 ES Manguera de ducha



FALA

No.	L [m]	
75652	1.5	50
75653	2.0	50

EN Flexible connecting hose
 PL Wąż przyłączeniowy elastyczny
 DE Edelstahl Flexschlauch
 RU Гибкий шланг для смесителя
 CS Flexibilní nerezové hadice na vodu
 RO Racorduri flexibile pt. apa
 HU Rugalmas rozsdamentes acél cső a víz
 ES Manguera flexible de acero inoxidable para el agua

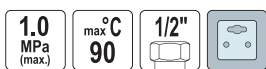

FALA

No.	L [mm]	
71800	300	180
71801	400	150
71802	500	120
71803	600	120
71804	800	100
71805	1000	80

EN Flexible connecting hose
 PL Wąż przyłączeniowy elastyczny
 DE Edelstahl Flexschlauch
 RU Гибкий шланг для смесителя
 CS Flexibilní nerezové hadice na vodu
 RO Racorduri flexibile pt. apa
 HU Rugalmas rozsdamentes acél cső a víz
 ES Manguera flexible de acero inoxidable para el agua

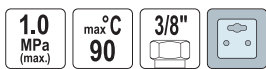

FALA

No.	L [mm]	
71814	300	250
71815	400	200
71816	500	150
71817	600	120
71818	800	100
71819	1000	80

EN Shower hose
 PL Wąż prysznicowy
 DE Brausenschlauch
 RU Шланг для душа
 CS Sprchová hadice
 RO Furtun duș
 HU Zuhanycső
 ES Manguera de ducha



FALA

No.	L [m]	
75654	1.5	50
75655	2.0	50

EN Flexible connecting hose
 PL Wąż przyłączeniowy elastyczny
 DE Edelstahl Flexschlauch
 RU Гибкий шланг для смесителя
 CS Flexibilní nerezové hadice na vodu
 RO Racorduri flexibile pt. apa
 HU Rugalmas rozsdamentes acél cső a víz
 ES Manguera flexible de acero inoxidable para el agua



FALA

No.	L [mm]	
71807	300	200
71808	400	150
71809	500	120
71810	600	100
71811	800	100
71812	1000	80

EN Flexible connecting hose
 PL Wąż przyłączeniowy elastyczny
 DE Edelstahl Flexschlauch
 RU Гибкий шланг для смесителя
 CS Flexibilní nerezové hadice na vodu
 RO Racorduri flexibile pt. apa
 HU Rugalmas rozsdamentes acél cső a víz
 ES Manguera flexible de acero inoxidable para el agua

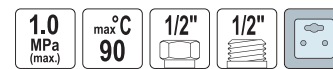

FALA

No.	L [mm]	
71820	300	200
71821	400	150
71822	500	120
71823	600	100
71824	800	10/100
71825	1000	80

EN Flexible connecting hose
 PL Wąż przyłączeniowy elastyczny
 DE Edelstahl Flexschlauch
 RU Гибкий шланг для смесителя
 CS Flexibilní nerezové hadice na vodu
 RO Racorduri flexibile pt. apa
 HU Rugalmas rozsdamentes acél cső a víz
 ES Manguera flexible de acero inoxidable para el agua

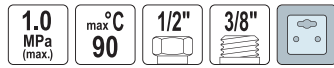

FALA

No.	L [mm]	
71827	300	150
71828	400	150
71829	500	100
71830	600	100
71831	800	100
71832	1000	10/80

EN Flexible connecting hose
 PL Wąż przyłączeniowy elastyczny
 DE Edelstahl Flexschlauch
 RU Гибкий шланг для смесителя
 CS Flexibilní nerezové hadice na vodu
 RO Racorduri flexibile pt. apa
 HU Rugalmas rozsdamentes acél cső a víz
 ES Manguera flexible de acero inoxidable para el agua

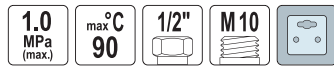

FALA

No.	L [mm]	
71840	300	200
71841	400	200
71842	500	150
71843	600	120
71844	800	100

EN Flexible connecting hose
 PL Wąż przyłączeniowy elastyczny
 DE Edelstahl Flexschlauch
 RU Гибкий шланг для смесителя
 CS Flexibilní nerezové hadice na vodu
 RO Racorduri flexibile pt. apa
 HU Rugalmas rozsdamentes acél cső a víz
 ES Manguera flexible de acero inoxidable para el agua

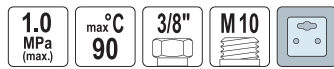

FALA

No.	L [mm]	
71851	300	250
71852	400	200
71853	500	150
71854	600	120
71855	800	100

EN Flexible connecting hose
 PL Wąż przyłączeniowy elastyczny
 DE Edelstahl Flexschlauch
 RU Гибкий шланг для смесителя
 CS Flexibilní nerezové hadice na vodu
 RO Racorduri flexibile pt. apa
 HU Rugalmas rozsdamentes acél cső a víz
 ES Manguera flexible de acero inoxidable para el agua

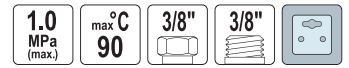

FALA

No.	L [mm]	
71833	300	180
71834	400	200
71835	500	200
71836	600	120
71837	800	100
71838	1000	80

EN Flexible connecting hose
 PL Wąż przyłączeniowy elastyczny
 DE Edelstahl Flexschlauch
 RU Гибкий шланг для смесителя
 CS Flexibilní nerezové hadice na vodu
 RO Racorduri flexibile pt. apa
 HU Rugalmas rozsdamentes acél cső a víz
 ES Manguera flexible de acero inoxidable para el agua

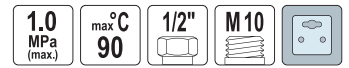

FALA

No.	L [mm]	
71846	300	225
71847	400	200
71848	500	150
71849	600	120
71850	800	100

EN Flexible connecting hose
 PL Wąż przyłączeniowy elastyczny
 DE Edelstahl Flexschlauch
 RU Гибкий шланг для смесителя
 CS Flexibilní nerezové hadice na vodu
 RO Racorduri flexibile pt. apa
 HU Rugalmas rozsdamentes acél cső a víz
 ES Manguera flexible de acero inoxidable para el agua

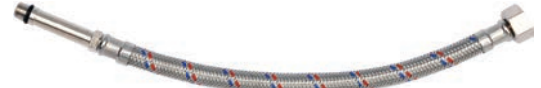
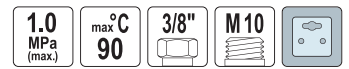

FALA

No.	L [mm]	
71856	300	200
71857	400	180
71858	500	150
71859	600	120
71860	800	10/100

EN Bathroom set
 PL Zestaw łazienkowy
 DE Brausegarnitur
 RU Набор для душевой
 CS Sprchová souprava
 RO Set pt. dus
 HU Zuhanyzó készlet
 ES Juego de baño ducha



EN Bathroom set
 PL Zestaw łazienkowy
 DE Brausegarnitur
 RU Набор для душевой
 CS Sprchová souprava
 RO Set pt. dus
 HU Zuhanyzó készlet
 ES Juego de baño ducha



FALA

No.

75555



12

FALA

No.

75556



12

EN Bathroom set
 PL Zestaw łazienkowy
 DE Brausegarnitur
 RU Набор для душевой
 CS Sprchová souprava
 RO Set pt. dus
 HU Zuhanyzó készlet
 ES Juego de baño ducha



EN Bathroom set
 PL Zestaw łazienkowy
 DE Brausegarnitur
 RU Набор для душевой
 CS Sprchová souprava
 RO Set pt. dus
 HU Zuhanyzó készlet
 ES Juego de baño ducha



FALA

No.

75558



12

FALA

No.

75559



16

EN Bathroom set
 PL Zestaw łazienkowy
 DE Brausegarnitur
 RU Набор для душевой
 CS Sprchová souprava
 RO Set pt. dus
 HU Zuhanyzó készlet
 ES Juego de baño ducha



EN Shower panel
 PL Panel prysznicowy
 DE Hydromassageduschpaneel
 RU Гидромассажная панель
 CS Hydromasážní panel
 RO Panou de hidromasaj
 HU Hidromassázs panel
 ES Columna de hidromasaje



FALA

No.

75660



5

FALA

No.

75980

Series / Seria

Steely 1



1

EN Shower panel
 PL Panel prysznicowy
 DE Hydromassageduschpaneel
 RU Гидромассажная панель
 CS Hydromasážní panel
 RO Panou de hidromasaj
 HU Hidromassázs panel
 ES Columna de hidromasaje



FALA

No.	Series / Seria	1
75981	Steely 2	1

EN Shower panel
 PL Panel prysznicowy
 DE Hydromassageduschpaneel
 RU Гидромассажная панель
 CS Hydromasážní panel
 RO Panou de hidromasaj
 HU Hidromassázs panel
 ES Columna de hidromasaje



FALA

No.	Series / Seria	1
75982	Steely 3	1

EN Shower panel
 PL Panel prysznicowy
 DE Hydromassageduschpaneel
 RU Гидромассажная панель
 CS Hydromasážní panel
 RO Panou de hidromasaj
 HU Hidromassázs panel
 ES Columna de hidromasaje



FALA

No.	Series / Seria	1
75977	Steely 4	1

EN Shower panel
 PL Panel prysznicowy
 DE Hydromassageduschpaneel
 RU Гидромассажная панель
 CS Hydromasážní panel
 RO Panou de hidromasaj
 HU Hidromassázs panel
 ES Columna de hidromasaje



FALA

No.	Series / Seria	1
75978	Steely 5	1

- EN Shower panel
- PL Panel prysznicowy
- DE Hydromassageduschpaneel
- RU Гидромассажная панель
- CS Hydromasážní panel
- RO Panou de hidromasaj
- HU Hidromassázs panel
- ES Columna de hidromasaje



FALA

No.	Series / Seria	1
75979	Steely 6	1

- EN Shower panel
- PL Panel prysznicowy
- DE Hydromassageduschpaneel
- RU Гидромассажная панель
- CS Hydromasážní panel
- RO Panou de hidromasaj
- HU Hidromassázs panel
- ES Columna de hidromasaje



FALA

No.	Series / Seria	1
75983	Steely 4	1

- EN Shower panel
- PL Panel prysznicowy
- DE Hydromassageduschpaneel
- RU Гидромассажная панель
- CS Hydromasážní panel
- RO Panou de hidromasaj
- HU Hidromassázs panel
- ES Columna de hidromasaje



FALA

No.	Series / Seria	1
75984	Steely 5	1

- EN Bathtub screen
- PL Parawan nawanowy
- DE Badewannenabtrennung
- RU Штора для ванн
- CS Vanová zástěna
- RO Paravan pt. duș
- HU Kádparavánok
- ES Mampara de bañera



FALA

No.	Series / Seria	1
68621		1



EN Bathtub screen
 PL Parawan nawanowy
 DE Badewannenabtrennung
 RU Штора для ванн
 CS Vanová zástěna
 RO Paravan pt. duș
 HU Kádparavánok
 ES Mampara de bañera



FALA

No.

68622



1

EN Tumbler
 PL Kubek kosmetyczny
 DE Becher
 RU Стакан
 CS Dóza
 RO Suport periuță
 HU Fürdőszobai pohár
 ES Vaso



FALA

No.

69301

Series / Seria

Oval Chrom



4/24

EN Towel ring
 PL Uchwyt na ręcznik
 DE Handtuchring
 RU Кольцо для полотенца
 CS Držák ručníků
 RO Portprosop
 HU Törölközőtartó
 ES Toallero anillo



FALA

No.

69305

Series / Seria

Oval Chrom



5/30

EN Bathtub screen
 PL Parawan nawanowy
 DE Badewannenabtrennung
 RU Штора для ванн
 CS Vanová zástěna
 RO Paravan pt. duș
 HU Kádparavánok
 ES Mampara de bañera



FALA

No.

68623



1

EN Soap dish
 PL Mydelniczka
 DE Seifenschale
 RU Мыльница
 CS Mydelnička
 RO Sapuniera
 HU Szappantartó tál
 ES Jabonera



FALA

No.

69302

Series / Seria

Oval Chrom



4/24

EN Towel ring
 PL Uchwyt na ręcznik
 DE Handtuchring
 RU Кольцо для полотенца
 CS Držák ručníků
 RO Portprosop
 HU Törölközőtartó
 ES Toallero



FALA

No.

69306

Series / Seria

Oval Chrom



4/24

- EN Toilet brush holder
- PL Szczotka WC
- DE WC-Garnitur
- RU Туалетная щетка настенная
- CS WC štětka
- RO Suport perie WC
- HU WC kefe
- ES Escobillero mura



FALA

No.	Series / Seria	Icon
69307	Oval Chrom	4/8

- EN Robe hook
- PL Haczyk pojedynczy
- DE Einzelhaken
- RU Крючок одинарный
- CS Háček
- RO Agatoareare simpla
- HU Fali akasztó
- ES Perchero de pared



FALA

No.	Series / Seria	Icon
69311	Quad Chrom	6/2

- EN Soap dish
- PL Mydelniczka
- DE Seifenschale
- RU Мыльница
- CS Mydelnička
- RO Sapuniera
- HU Szappantartó tál
- ES Jabonera



FALA

No.	Series / Seria	Icon
69313	Quad Chrom	4/24

- EN Toilet paper holder
- PL Uchwyt na papier toaletowy
- DE WC Papierhalter
- RU Держатель для туалетной бумаги без крышек
- CS Držák na toaletní papír
- RO Porthartie
- HU WC papír tartó
- ES Portarrollos para papel higiénico



FALA

No.	Series / Seria	Icon
69315	Quad Chrom	4/24

- EN Glass shelf
- PL Półka szklana
- DE Ablagekonsole aus Glas
- RU Этажерка настенная
- CS Pólička do koupelny
- RO Polita sticla
- HU Pipepólc - üveg
- ES Estante



FALA

No.	Series / Seria	Icon
69308	Oval Chrom	4/8

- EN Tumbler
- PL Kubek kosmetyczny
- DE Becher
- RU Стакан
- CS Dóza
- RO Suport periută
- HU Fürdőszobai pohár
- ES Vaso



FALA

No.	Series / Seria	Icon
69312	Quad Chrom	4/24

- EN Toilet paper holder
- PL Uchwyt na papier toaletowy
- DE WC Papierhalter
- RU Держатель для туалетной бумаги без крышек
- CS Držák na toaletní papír
- RO Porthartie
- HU WC papír tartó
- ES Portarrollos para papel higiénico



FALA

No.	Series / Seria	Icon
69314	Quad Chrom	4/24

- EN Toilet paper holder
- PL Uchwyt na zapasowy papier
- DE Reserverpapierhalter
- RU Держатель для запасного рулона туалетной бумаги
- CS Držák na toaletní papír
- RO Porthartie igienica
- HU WC papír tartó
- ES Portarrollos para papel higiénico



FALA

No.	Series / Seria	Icon
69316	Quad Chrom	5/30

EN Towel ring
 PL Uchwyt na ręcznik
 DE Handtuchring
 RU Кольцо для полотенца
 CS Držák ručníků
 RO Portprosop
 HU Törölközőtartó
 ES Toallero anillo



FALA

No.	Series / Seria	
69317	Quad Chrom	4/24

EN Towel ring
 PL Uchwyt na ręcznik
 DE Handtuchring
 RU Кольцо для полотенца
 CS Držák ručníků
 RO Portprosop
 HU Törölközőtartó
 ES Toallero anillo



FALA

No.	Series / Seria	
69319	Quad Chrom	4/24

EN Glass shelf
 PL Półka szklana
 DE Ablagekonsole aus Glas
 RU Этажерка настенная
 CS Půlčička do koupelny
 RO Polita sticla
 HU Piperepolc - üveg
 ES Estante



FALA

No.	Series / Seria	
69321	Quad Chrom	4/8

EN Toothbrush holder
 PL Kubek na szczoteczki do zębów
 DE Zahnputzbecher
 RU Стакан для зубных щеток
 CS Dóza na zubní kartáčky
 RO Suport pt. periute dinti
 HU Fogkefzetartó pohár
 ES Portacepillos



FALA

No.	Series / Seria	
69331	Tier	6/120

EN Towel ring
 PL Uchwyt na ręcznik
 DE Handtuchring
 RU Кольцо для полотенца
 CS Držák ručníků
 RO Portprosop
 HU Törölközőtartó
 ES Toallero anillo



FALA

No.	Series / Seria	
69318	Quad Chrom	4/24

EN Toilet brush holder
 PL Szczotka WC
 DE WC-Garnitur
 RU Туалетная щетка настенная
 CS WC štětka
 RO Suport perie WC
 HU WC kefe
 ES Escobillero mura



FALA

No.	Series / Seria	
69320	Quad Chrom	4/8

EN Tumbler
 PL Kubek kosmetyczny
 DE Becher
 RU Стакан
 CS Dóza
 RO Suport periuță
 HU Fürdőszobai pohár
 ES Vaso



FALA

No.	Series / Seria	
69330	Tier	6/120

EN Soap dish
 PL Mydlniczka
 DE Seifenschale
 RU Мыльница
 CS Mydlnička
 RO Sapuniera
 HU Szappantartó tál
 ES Jabonera



FALA

No.	Series / Seria	
69332	Tier	6/144

- EN Lotion dispenser
- PL Dozownik mydła w płynie
- DE Seifenspender
- RU Дозатор для жидкого мыла
- CS Dávkočac mýdla
- RO Dozator sapun
- HU Folyékony szappan adagoló
- ES Dosificador



FALA

No.	Series / Seria	
69333	Tier	6/96

- EN Tumbler
- PL Kubek kosmetyczny
- DE Becher
- RU Стакан
- CS Dóza
- RO Suport periută
- HU Fürdőszobai pohár
- ES Vaso



FALA

No.	Series / Seria	
69337	Cuboid White	6/144

- EN Soap dish
- PL Mydelniczka
- DE Seifenschale
- RU Мыльница
- CS Mydelnička
- RO Sapuniera
- HU Szappantartó tál
- ES Jabonera



FALA

No.	Series / Seria	
69339	Cuboid White	6/144

- EN Toilet brush holder
- PL Szczotka WC
- DE WC-Bürste
- RU Щетка туалетная
- CS WC kartáč
- RO Perie WC
- HU WC kefe tartó
- ES Escobillero



FALA

No.	Series / Seria	
69341	Cuboid White	6/48

- EN Toilet brush holder
- PL Szczotka WC
- DE WC-Bürste
- RU Щетка туалетная
- CS WC kartáč
- RO Perie WC
- HU WC kefe tartó
- ES Escobillero



FALA

No.	Series / Seria	
69334	Tier	6/24

- EN Toothbrush holder
- PL Kubek na szczoteczki do zębów
- DE Zahnputzbecher
- RU Стакан для зубных щеток
- CS Dóza na zubní kartáčky
- RO Suport pt. periute dinti
- HU Fogkefetartó pohár
- ES Portacepillos



FALA

No.	Series / Seria	
69338	Cuboid White	6/72

- EN Lotion dispenser
- PL Dozownik mydła w płynie
- DE Seifenspender
- RU Дозатор для жидкого мыла
- CS Dávkočac mýdla
- RO Dozator sapun
- HU Folyékony szappan adagoló
- ES Dosificador



FALA

No.	Series / Seria	
69340	Cuboid White	6/72

- EN Tumbler
- PL Kubek kosmetyczny
- DE Becher
- RU Стакан
- CS Dóza
- RO Suport periută
- HU Fürdőszobai pohár
- ES Vaso



FALA

No.	Series / Seria	
69344	Cuboid Beige	6/144

EN Toothbrush holder
 PL Kubek na szczoteczki do zębów
 DE Zahnputzbecher
 RU Стакан для зубных щеток
 CS Dóza na zubní kartáčky
 RO Suport pt. perute dinti
 HU Fogkefektartó pohár
 ES Portacepillos



FALA

No.	Series / Seria	
69345	Cuboid Beige	6/72

EN Lotion dispenser
 PL Dozownik mydła w płynie
 DE Seifenspender
 RU Дозатор для жидкого мыла
 CS Dávkovač mydla
 RO Dozator sapun
 HU Folyékony szappan adagoló
 ES Dosificador



FALA

No.	Series / Seria	
69347	Cuboid Beige	6/72

EN Tumbler
 PL Kubek kosmetyczny
 DE Becher
 RU Стакан
 CS Dóza
 RO Suport periută
 HU Fürdőszobai pohár
 ES Vaso



FALA

No.	Series / Seria	
69350	Nickel	6/96

EN Soap dish
 PL Mydelniczka
 DE Seifenschale
 RU Мыльница
 CS Mydelnička
 RO Sapuniera
 HU Szappantartó tál
 ES Jabonera



FALA

No.	Series / Seria	
69352	Nickel	6/192

EN Soap dish
 PL Mydelniczka
 DE Seifenschale
 RU Мыльница
 CS Mydelnička
 RO Sapuniera
 HU Szappantartó tál
 ES Jabonera



FALA

No.	Series / Seria	
69346	Cuboid Beige	6/144

EN Toilet brush holder
 PL Szczotka WC
 DE WC-Bürste
 RU Щетка туалетная
 CS WC kartáč
 RO Perie WC
 HU WC kefe tartó
 ES Escobillero



FALA

No.	Series / Seria	
69348	Cuboid Beige	6/48

EN Toothbrush holder
 PL Kubek na szczoteczki do zębów
 DE Zahnputzbecher
 RU Стакан для зубных щеток
 CS Dóza na zubní kartáčky
 RO Suport pt. perute dinti
 HU Fogkefektartó pohár
 ES Portacepillos



FALA

No.	Series / Seria	
69351	Nickel	6/96

EN Lotion dispenser
 PL Dozownik mydła w płynie
 DE Seifenspender
 RU Дозатор для жидкого мыла
 CS Dávkovač mydla
 RO Dozator sapun
 HU Folyékony szappan adagoló
 ES Dosificador



FALA

No.	Series / Seria	
69353	Nickel	6/72

- EN Toilet brush holder
- PL Szczotka WC
- DE WC-Bürste
- RU Щетка туалетная
- CS WC kartáč
- RO Perie WC
- HU WC kefe tartó
- ES Escobillero



FALA

No.	Series / Seria	Icon
69354	Nickel	6/24

- EN Robe hook
- PL Haczyk pojedynczy
- DE Einzelhaken
- RU Крючок одинарный
- CS Háček
- RO Agatatoare simpla
- HU Fali akasztó
- ES Perchero de pared



FALA

No.	Series / Seria	Icon
69371	Steely	330

- EN Robe hook
- PL Haczyk podwójny
- DE Einzelhaken
- RU Крючок одинарный
- CS Háček
- RO Agatatoare simpla
- HU Fali akasztó
- ES Perchero de pared



FALA

No.	Series / Seria	Icon
69373	Steely	220

- EN Toilet paper holder
- PL Uchwyt na papier toaletowy
- DE WC Papierhalter
- RU Держатель для туалетной бумаги без крышек
- CS Držák na toaletní papír
- RO Porthartie
- HU WC papír tartó
- ES Portarrollos para papel higiénico



FALA

No.	Series / Seria	Icon
69375	Steely	50

- EN Robe hook
- PL Haczyk pojedynczy
- DE Einzelhaken
- RU Крючок одинарный
- CS Háček
- RO Agatatoare simpla
- HU Fali akasztó
- ES Perchero de pared



FALA

No.	Series / Seria	Icon
69370	Steely	165

- EN Robe hook
- PL Haczyk podwójny
- DE Einzelhaken
- RU Крючок одинарный
- CS Háček
- RO Agatatoare simpla
- HU Fali akasztó
- ES Perchero de pared

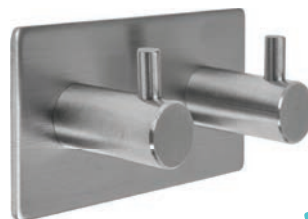

FALA

No.	Series / Seria	Icon
69372	Steely	110

- EN Towel ring
- PL Uchwyt na ręcznik
- DE Handtuchring
- RU Кольцо для полотенца
- CS Držák ručníků
- RO Portprosop
- HU Törölközőtartó
- ES Toallero anillo



FALA

No.	Series / Seria	Icon
69374	Steely	25

- EN Towel rail robe hook
- PL Uchwyt na ręcznik haczyk
- DE Badetuchstange Einzelhaken
- RU Вешалка для полотенца крючок одинарный
- CS Držák ručníků háček
- RO Portprosop ag atatoare simpla
- HU Törölközőtartó akasztó
- ES Toallero anillo perchero de pared



FALA

No.	Series / Seria	Icon
69376	Steely	20

EN Shelf
 PL Półka
 DE Ablagekonsole
 RU Этажерка настенная
 CS Polička do koupelny
 RO Polita
 HU Piperepolc
 ES Estante



FALA

No.	Series / Seria	
69377	Steely	30

EN Toilet seat
 PL Deska sedesowa
 DE WC Deckel
 RU Сиденье для унитаза
 CS WC sedátko
 RO Capac WC
 HU WC-ülőke
 ES Asiento de inodoro

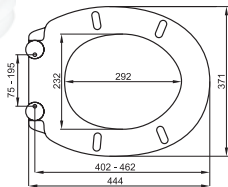

FALA

No.		
75465		5

EN Toilet seat
 PL Deska sedesowa
 DE WC Deckel
 RU Сиденье для унитаза
 CS WC sedátko
 RO Capac WC
 HU WC-ülőke
 ES Asiento de inodoro

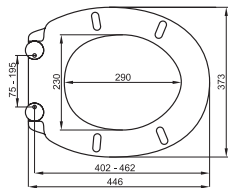

FALA

No.		
75468		5

EN Shelf
 PL Półka
 DE Ablagekonsole
 RU Этажерка настенная
 CS Polička do koupelny
 RO Polita
 HU Piperepolc
 ES Estante



FALA

No.	Series / Seria	
69378	Steely	30

EN Toilet seat
 PL Deska sedesowa
 DE WC Deckel
 RU Сиденье для унитаза
 CS WC sedátko
 RO Capac WC
 HU WC-ülőke
 ES Asiento de inodoro

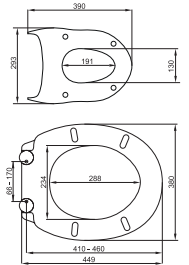

FALA

No.		
75467		5

EN Toilet seat
 PL Deska sedesowa
 DE WC Deckel
 RU Сиденье для унитаза
 CS WC sedátko
 RO Capac WC
 HU WC-ülőke
 ES Asiento de inodoro

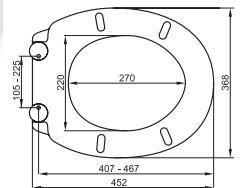

FALA

No.		
75469		5

EN Toilet seat
 PL Deska sedesowa
 DE WC Deckel
 RU Сиденье для унитаза
 CS WC sedátko
 RO Capac WC
 HU WC-ülőke
 ES Asiento de inodoro

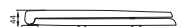
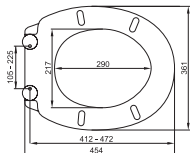

FALA

No.

75464



5

EN Toilet seat
 PL Deska sedesowa
 DE WC Deckel
 RU Сиденье для унитаза
 CS WC sedátko
 RO Capac WC
 HU WC-ülőke
 ES Asiento de inodoro

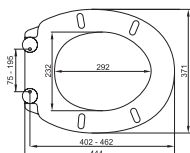

FALA

No.

75471



5

EN LED toilet light
 PL Lampka LED do podświetlania WC
 DE WC LED Lampe
 RU LED ночник для туалета
 CS WC LED světlo
 RO Lumină pt. toaletă
 HU LED WC megvilágítás
 ES WC LED lámpara



FALA

No.

75455



100

EN Toilet seat
 PL Deska sedesowa
 DE WC Deckel
 RU Сиденье для унитаза
 CS WC sedátko
 RO Capac WC
 HU WC-ülőke
 ES Asiento de inodoro

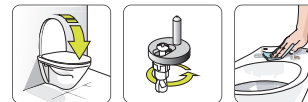

FALA

No.

75470



6

EN Toilet seat
 PL Deska sedesowa
 DE WC Deckel
 RU Сиденье для унитаза
 CS WC sedátko
 RO Capac WC
 HU WC-ülőke
 ES Asiento de inodoro

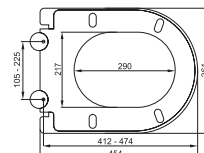

FALA

No.

75472



5

EN Wall hung toilet with seat
 PL Miska WC wisząca z deską
 DE Toilettenschüssel
 RU Унитаз подвесной
 CS WC závěsný
 RO WC suspendat
 HU WC fűhár
 ES Inodoro



FALA

No.

68800



1

EN Wall hung toilet with seat
 PL Miska WC wisząca z deską
 DE Toilettenschüssel
 RU Унитаз подвесной
 CS WC závěsný
 RO WC suspendat
 HU WC fehér
 ES Inodoro



FALA

No.	Series / Seria	1
68801		1

EN Basin
 PL Umywalka nabladowa
 DE Waschbecken
 RU Умывальник
 CS Umyvadlo
 RO Chiuveta
 HU Mosdó
 ES Lavabo



FALA

No.	Series / Seria	1
68830	Top	1

EN Basin
 PL Umywalka nabladowa
 DE Waschbecken
 RU Умывальник
 CS Umyvadlo
 RO Chiuveta
 HU Mosdó
 ES Lavabo



FALA

No.	Series / Seria	1
68832	Top	1

EN Basin oval
 PL Umywalka nabladowa
 DE Waschbecken
 RU Умывальник
 CS Umyvadlo
 RO Chiuveta
 HU Mosdó
 ES Lavabo

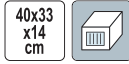

FALA

No.	Series / Seria	1
68820	Oval	1

EN Basin
 PL Umywalka nabladowa
 DE Waschbecken
 RU Умывальник
 CS Umyvadlo
 RO Chiuveta
 HU Mosdó
 ES Lavabo



FALA

No.	Series / Seria	1
68831	Top	1

EN Basin
 PL Umywalka nabladowa
 DE Waschbecken
 RU Умывальник
 CS Umyvadlo
 RO Chiuveta
 HU Mosdó
 ES Lavabo



FALA

No.	Series / Seria	1
68833	Top	1

Weight/BMI – the Body Mass Index (BMI), defined as the body mass divided by the body height, is a quantification for categorizing human weight and health status.



WEIGHT

Wskaźnik masy ciała - Body Mass Index (BMI) definiuje się jako wartość masy ciała podzieloną przez kwadrat wzrostu; jest to wartość używana do klasyfikowania ludzkiej wagi i stanu zdrowia.

Weight/BMI – the Body Mass Index (BMI), defined as the body mass divided by the body height, is a quantification for categorizing human weight and health status.



BMI

Wskaźnik masy ciała - Body Mass Index (BMI) definiuje się jako wartość masy ciała podzieloną przez kwadrat wzrostu; jest to wartość używana do klasyfikowania ludzkiej wagi i stanu zdrowia.

Metabolism – Basal Metabolic Rate (BMR) is the minimal rate of energy expenditure unit time by human at rest, expressed in calories. It was measured under the circumstances when a man is awake and at complete rest.



BMR

Wskaźnik podstawowej przemiany materii - Basal Metabolic Rate (BMR) to minimalna ilość energii wyrażona w kaloriach, potrzebna do funkcjonowania organizmu w czasie odpoczynku.

Fat percentage is the total mass of fat divided by total body mass. It provides a better assessment for how fat or thin person is compared to BMI.



FAT

Procent tłuszczu ciała to całkowita masa tłuszczu podzielona przez całkowitą masę ciała; wskaźnik tłuszczu ciała odnosi się do niezbędnego tłuszczu i metabolizmu.

Body water percentage is closely related to body muscle mass, since muscle contains a large amount of water (approx. 70%).



WATER

Procent wody w organizmie jest ściśle związany z masą mięśniową, ponieważ mięśnie zawierają dużą ilość wody (ok. 70%).

Visceral Fat is fat stored within the abdominal cavity around a number of internal organs.



VISCERALfat

Tłuszcz trzewny to tłuszcz magazynowany w podbrzuszu wokół wielu narządów wewnętrznych.

Muscle mass index is calculated from muscle mass, body weight and height. It is a quantitative assessment of health status and strength.



MUSCLE

Wskaźnik masy mięśniowej jest wyliczany na podstawie masy mięśni, wagi ciała i wzrostu. To ilościowe rozumienie stanu zdrowia i siły.

Bone Mass – the human skeleton, composed of bones, supports the human body. Bone mineral density and calcium loss are the main concerns for bone health.

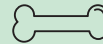

BONES

Ludzki szkielet, składający się z kości, podtrzymuje ciało. Gęstości kości i utrata wapnia to główne problemy dla zdrowia kości.

EN Bathroom scale
PL Waga łazienkowa
DE Personenwaage
RU Ванная шкала
CS Váha do koupelny
RO Cantar baie
HU Személmérleg
ES Bascula de baño

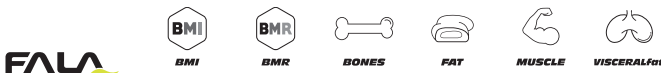
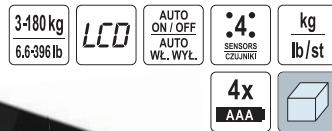

No.	
69203	8

EN Bathroom scale
PL Waga łazienkowa
DE Personenwaage
RU Ванная шкала
CS Váha do koupelny
RO Cantar baie
HU Személmérleg
ES Bascula de baño

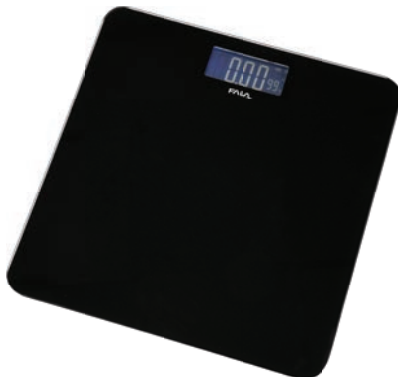
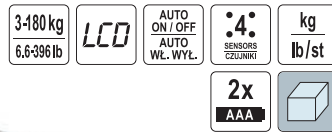

No.	
69205	8

EN Bathroom scale
PL Waga łazienkowa
DE Personenwaage
RU Ванная шкала
CS Váha do koupelny
RO Cantar baie
HU Személmérleg
ES Bascula de baño

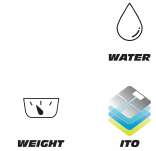
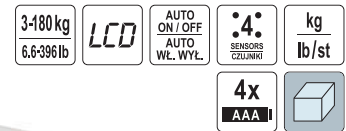

No.	
69204	8

EN Plastic stool
PL Stolek plastikowy
DE Kunststoff Hocker
RU Пластиковый табурет
CS Plastová stolička
RO Scaun de plastic
HU Műanyag székiel
ES Taburete de plástico



No.	Dimensions / Wymiary [mm]	
75915	300x200x210	10/20

EN Plastic stool
 PL Stółek plastikowy
 DE Kunststoff Hocker
 RU Пластиковый табурет
 CS Plastová stolička
 RO Scaun de plastic
 HU Műanyag széket
 ES Taburete de plástico



FALA

No.	Dimensions / Wymiary [mm]	
75916	300x200x210	10/20

EN Waste pump for shower and basin
 PL Pompa łazienkowa do pryszniców i umywalk
 DE Haushaltspumpe für Dusche und Waschtisch
 RU Санитарный насос
 CS Koupelňové čerpadlo pro sprchy
 RO Pompa pt. ape uzate - dus, lovoar
 HU Szivattyú zuhanyzóhoz
 ES Bomba de evacuación



FALA

No.	Power / Moc [W]	
75945	250	1

EN Sewage lifting station with grinder
 PL Pompa sanitarna z rozdrabniaczem
 DE Kleinhebeanlage fäkalienthaltiges Abwasser
 RU Канализационная насосная установка
 CS Sanitární kalové čerpadlo
 RO Stația pt. evacuarea apelor uzate
 HU Átemelő szivattyú
 ES Estación de levantamiento para aguas residuales



FALA

No.	Power / Moc [W]	
75953	600	1

EN Waste pump for shower and basin
 PL Pompa łazienkowa do prysznic i umywalki
 DE Haushaltspumpe für Dusche und Waschtisch
 RU Санитарный насос
 CS Koupelňové čerpadlo pro sprchy
 RO Pompa pt. ape uzate - dus, lovoar
 HU Szivattyú zuhanyzóhoz
 ES Bomba de evacuación



FALA

No.	Power / Moc [W]	
75944	250	4

EN Sewage lifting station with grinder
 PL Pompa sanitarna z rozdrabniaczem
 DE Kleinhebeanlage fäkalienthaltiges Abwasser
 RU Канализационная насосная установка
 CS Sanitární kalové čerpadlo
 RO Stația pt. evacuarea apelor uzate
 HU Átemelő szivattyú
 ES Estación de levantamiento para aguas residuales



FALA

No.	Power / Moc [W]	
75951	600	1



Convenient and easy to use.
Wygodna i łatwa obsługa.



Rotation 360°

Mixing water flow with intake air reduces consumption by half, without splashing.
Zmieszany strumień wody z zasysanym powietrzem oszczędza zużycie o połowę i nie chlapie.



ECOflow

Additional protection against contamination.
Dodatkowa ochrona przed zanieczyszczeniami.







built-in-filter

Simple and effective installation thanks to the nut.
Łatwy i trwały montaż dzięki nakrętce.



SMARTnut

EN Instant heating faucet
PL Przepływowy podgrzewacz wody z baterią
DE Elektrische Warmwasser-Armatur
RU Миттевий водонагрівач
CS Ohřívač vody
RO Robinet electric
HU Átfolyós vízmelegítő csaptelep
ES Calefacción instantáneo grifo





220-240V~50-60Hz **3000 W** 1/2" 0.04-0.6 MPa **200 mm**
1.2 m    



FALA

No.	Series / Seria	
75930	Strokkur 1	10

EN Instant heating faucet
PL Przepływowy podgrzewacz wody z baterią
DE Elektrische Warmwasser-Armatur
RU Миттевий водонагрівач
CS Ohřívač vody
RO Robinet electric
HU Átfolyós vízmelegítő csaptelep
ES Calefacción instantáneo grifo

220-240V~50-60Hz **3000 W** 1/2" 0.04-0.6 MPa **100 mm**
1.2 m    





FALA

No.	Series / Seria	
75931	Strokkur 2	10

EN Instant heating faucet
PL Przepływowy podgrzewacz wody z baterią
DE Elektrische Warmwasser-Armatur
RU Миттевий водонагрівач
CS Ohřívač vody
RO Robinet electric
HU Átfolyós vízmelegítő csaptelep
ES Calefacción instantáneo grifo





220-240V~50-60Hz **3000 W** 1/2" 0.04-0.6 MPa **200 mm** 1.2 m    

FALA

No.	Series / Seria	
75932	Strokkur 3	10

EN Instant heating faucet
PL Przepływowy podgrzewacz wody z baterią
DE Elektrische Warmwasser-Armatur
RU Миттевий водонагрівач
CS Ohřívač vody
RO Robinet electric
HU Átfolyós vízmelegítő csaptelep
ES Calefacción instantáneo grifo





230V~50Hz **3000 W** 1/2" 0.1-0.6 MPa **LCD** 1.2 m    



FALA

No.	Series / Seria	
75921	Katla 1	10

EN Instant heating faucet
PL Przepływowy podgrzewacz wody z baterią
DE Elektrische Warmwasser-Armatur
RU Миттевий водонагрівач
CS Ohřívač vody
RO Robinet electric
HU Átfolyós vízmelegítő csaptelep
ES Calefacción instantáneo grifo

230V~50Hz **3000 W** 1/2" 0.1-0.6 MPa **LCD** 1.2 m    



FALA

No.	Series / Seria	
75922	Katla 2	10

EN Instant heating faucet
 PL Przepływowy podgrzewacz wody z baterią
 DE Elektrische Warmwasser-Armatur
 RU Миттевий водонагревач
 CS Ohříváč vody
 RO Robinet electric
 HU Átfolyós vízmelegítő csaptelep
 ES Calefacción instantáneo grifo

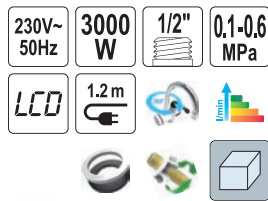

FALA

No.	Series / Seria	
75923	Katla 3	10

EN Drain cleaner
 PL Pistolet do udrażniania rur
 DE Pistole zum Reinigen von Röhren
 RU Пневматический пистолет для прочистки труб
 CS Pistole na čištění trubek
 RO Pistol pt. curățarea țevilor
 HU Csőtisztító pisztoly
 ES Pistola desatapaños



VOREL

No.	Ø [mm]	
55500	63, 135	10

EN Drain auger
 PL Spirala kanalizacyjna
 DE Hand-Rohrreinigungsspirale
 RU Трос сантехнический для чистки труб
 CS Spirála kanalizační
 RO Dispozitiv de defundat scurgere
 HU Csőtisztító spirál
 ES Desatascador espiral



VOREL

No.	Ø [mm]	L [m]	
55541	5	1.5	20/80
55542	6	3.0	18/36

EN Instant heating faucet
 PL Przepływowy podgrzewacz wody z baterią
 DE Elektrische Warmwasser-Armatur
 RU Миттевий водонагревач
 CS Ohříváč vody
 RO Robinet electric
 HU Átfolyós vízmelegítő csaptelep
 ES Calefacción instantáneo grifo



FALA

No.	Series / Seria	
75924	Katla 4	10

EN Drain suction pump
 PL Pompa do udrażniania kanalizacji
 DE Hochdruck-Rohrreiner
 RU Пневматический вантуз для прочистки труб
 CS Čerpadlo na čištění trubek
 RO Pompă pt. curățarea țevilor
 HU Csőtisztító szivattyú
 ES El desagüe del fregadero limpiador



VOREL

No.	Ø [mm]	
55505	65, 155	24

EN Drain auger
 PL Spirala kanalizacyjna
 DE Hand-Rohrreinigungsspirale
 RU Трос сантехнический для чистки труб

CS Spirála kanalizační
 RO Dispozitiv de defundat scurgere
 HU Csőtisztító spirál
 ES Desatascador espiral



VOREL

No.	Ø [mm]	L [m]	
55544	9	5	5/10
55545	9	10	4/8

No.	Page	No.	Page	No.	Page	No.	Page	No.	Page	No.	Page	No.	Page	No.	Page
00250	154	04640	157	05901	170	06380	165	06973	105	07957	120	08576	119	08853	94
00300	150	04650	157	05902	170	06388	182, 466	06974	105	07960	120	08578	119	08854	94
00320	150	04660	157	05903	170	06390	182, 466	06975	105	07962	120	08580	119	08855	94
00510	150	04668	157	05904	170	06391	182	06976	105	07970	119	08582	119	08860	96
00610	150	04670	157	05905	170	06392	182, 466	06977	105	07974	95	08585	119	08861	96
01060	150	04677	156	05906	170	06393	182, 466	06978	105	07975	95	08630	94	08864	96
02300	150	04680	156	05911	170	06394	183	06979	105	07976	95	08631	94	08865	96
02400	150	04681	156	05912	170	06395	183	06980	105	07977	95	08633	94	08868	96
03150	150	04682	156	05913	170	06396	183	06981	105	07978	95	08635	94	08869	96
03160	150	04683	157	05914	170	06397	182	06982	105	07984	95	08639	94	08873	96
03220	150	04684	157	05915	170	06398	182	06983	105	07985	95	08640	94	08875	96
03221	151	04690	154	05916	170	06399	182	06985	105	07986	95	08641	94	08876	96
03225	151	04691	154	05921	170	06400	163	06986	105	07987	95	08642	94	09005	172
03240	88	04692	155	05922	170	06401	163	06987	106	07988	95	08644	94	09006	172
03241	88	04693	155	05923	170	06410	163	06988	106	08170	94	08646	94	09010	172
03245	88	04699	154	05924	170	06420	163	06989	106	08171	94	08663	95	09015	172
03246	88	04700	157	05925	170	06430	163	06990	106	08174	94	08665	95	09017	172
03300	89	04710	157	05926	170	06440	163	06992	106	08175	94	08669	95	09025	172
03301	89	04714	155	05950	168	06450	174	06993	106	08190	95	08671	95	09028	173
03900	152	04715	155	05960	169	06452	174	06994	106	08191	95	08672	95	09031	172
03940	152	04716	155	05971	169	06453	174	06995	106	08288	118	08674	95	09032	173
03950	152	04717	155	05972	169	06457	174	07060	117	08289	118	08683	95	09036	173
03960	152	04718	156	05973	169	06460	174	07080	117	08290	118	08688	95	09038	173
03990	88	04720	158	05980	169	06470	163	07100	117	08291	118	08711	93	09038	173
04000	151	04721	158	06030	168	06472	163	07120	117	08292	118	08712	93	09040	173
04020	151	04750	167	06040	168	06500	164	07180	117	08293	118	08714	93	09044	173
04022	151	04755	167	06050	168	06510	164	07240	117	08300	106	08715	93	09046	173
04050	153	04756	167	06060	168	06512	165	07320	117	08301	118	08731	93	09048	173
04100	153	04770	167	06080	168	06520	164	07400	117	08302	118	08732	93	09049	173
04200	151	05050	111	06100	168	06530	164	07506	117	08303	118	08734	93	09050	173
04210	151	05100	111	06109	166	06532	165	07508	117	08304	118	08735	93	09051	173
04300	48, 134	05300	183	06110	166	06537	165	07510	117	08306	118	08751	93	09052	173
04301	48, 134	05301	183	06120	166	06538	165	07512	117	08307	118	08752	93	09054	173
04360	170	05302	183	06121	166	06540	164	07530	118	08308	118	08754	93	09056	173
04400	151	05311	183	06130	168	06640	164	07540	118	08312	106	08755	93	09060	172
04405	152	05312	183	06150	168	06650	164	07560	118	08314	107	08780	93	09062	174
04410	152	05540	89	06290	168	06660	164	07580	118	08315	107	08781	93	09063	174
04440	152	05560	89	06294	169	06670	164	07610	118	08316	107	08782	93	09065	174
04450	138	05580	89	06295	169	06680	164	07620	118	08318	107	08783	93	09077	174
04451	139	05600	89	06296	169	06690	164	07630	118	08350	107	08785	93	09080	172
04452	139	05750	171	06297	169	06700	164	07664	118	08400	107	08786	93	09090	172
04490	153	05751	171	06298	169	06701	165	07665	118	08410	107	08787	93	09094	173
04500	153	05752	171	06299	169	06740	165	07666	118	08500	107	08788	93	09096	174
04510	153	05760	171	06300	169	06760	165	07667	118	08501	107	08790	93	09097	174
04540	153	05761	171	06301	169	06780	165	07668	118	08510	107	08791	93	09100	138
04542	153	05770	171	06302	169	06781	165	07879	118	08511	108	08792	93	09120	138
04544	154	05771	171	06303	169	06790	171	07880	118	08520	108	08793	93	09130	138
04546	154	05772	171	06304	169	06795	170	07881	118	08521	108	08811	94	09150	138
04561	357	05773	171	06305	169	06796	171	07882	118	08522	108	08819	94	09160	138
04562	357	05774	171	06306	169	06797	170	07883	118	08534	119	08820	94	09163	140
04581	157	05801	166	06307	169	06799	171	07884	118	08536	119	08821	94	09165	140
04582	157	05802	166	06308	169	06820	111	07885	118	08538	119	08822	94	09170	139
04583	157	05803	166	06309	169	06840	112	07886	118	08540	119	08825	94	09171	139
04584	157	05804	166	06310	170	06860	112	07910	118	08542	119	08827	94	09172	139
04585	157	05805	166	06320	170	06930	104	07911	118	08545	119	08828	94	09173	140
04586	157	05806	166	06330	170	06940	104	07912	118	08553	119	08829	94	09174	139
04591	157	05807	166	06331	170	06950	104	07913	118	08554	119	08831	94	09177	140
04592	157	05821	166	06335	171	06960	104	07914	118	08555	119	08832	94	09180	184
04593	157	05822	166	06340	165	06963	104	07915	118	08556	119	08833	94	09190	184
04594	157	05823	166	06341	165	06964	104	07916	118	08558	119	08834	94	09302	176
04600	157	05830	167	06350	165	06965	105	07930	116	08560	119	08835	94	09303	176
04610	157	05831	167	06351	165	06970	105	07950	119	08562	119	08837	94	09307	175
04620	157	05840	167	06360	165	06971	105	07955	119	08565	119	08838	94	09308	175
04630	157	05850	167	06370	165	06972	105	07956	120	08573	119	08845	94	09310	176
										08574	119	08851	94	09311	176

No.	Page	No.	Page	No.	Page	No.	Page	No.	Page	No.	Page	No.	Page	No.	Page
09331	176	09532	178	12200	191	17484	146, 195	18800	200	21934	82	23376	86	23740	85
09332	176	09533	178	12300	191	17488	145, 195	18810	200	21936	82	23377	86	23750	85
09334	175	09534	178	12500	191	17489	145, 195	19740	201	21941	82	23379	86	23752	85
09336	175	09535	178	13200	192	17490	145, 194	19750	201	21944	82	23380	86	23800	85
09338	176	09536	178	13300	192	17495	145, 194, 195	19755	201	21948	82	23381	86	23820	85
09345	175	09537	178	13500	192	17497	145, 195	19763	201	21950	82	23382	86	23830	85
09346	175	09560	178	14100	192	17498	145, 195	19765	201	21951	82	23390	86	23832	85
09359	175	09561	178	14200	192	17500	194	19766	201	21952	82	23391	86	23840	85
09363	176	09562	178	14300	192	17501	194	19767	201	21955	82	23392	86	23850	85
09365	176	09581	178	14500	192	17505	194	19770	201	21956	82	23393	86	23860	85
09370	175	09583	178	15004	192	17506	194	20100	81	21958	82	23394	86	23862	85
09371	176	09585	178	15005	192	17507	194	20150	81	21961	82	23395	86	23880	85
09372	176	09587	178	15006	192	17508	194	20200	81	21963	82	23396	86	23882	85
09373	176	09589	178	15007	192	17560	204	20250	81	21966	82	23397	86	23883	85
09375	176	09590	179	15010	192	17570	200	20280	81	21998	82	23398	86	23920	85
09377	176	09636	178	15020	192	17606	205	20300	81	21999	82	23399	86	23930	85
09378	176	09638	178	15050	193	17608	205	20320	81	22130	81	23400	86	23932	85
09385	177	09640	178	15070	193	17610	205	20350	81	22180	81	23402	86	23960	85
09390	177	09642	178	15100	193	17612	205	20400	81	22190	81	23403	86	23962	85
09395	177	09647	178	15110	193	17615	205	20420	81	22250	81	23411	86	23980	85
09397	175	09648	178	15113	194	17620	205	20450	81	22300	81	23412	86	23982	85
09400	182	09649	178	15115	193	17701	160, 467	20500	81	22310	81	23413	86	23988	86
09406	177	09650	179	15120	193	17702	161, 468	20550	81	22330	81	23414	86	23990	85
09408	177	09651	178	15130	193	17704	161, 468	20600	81	22340	81	23415	86	23992	85
09413	177	09653	179	15200	193	17705	162, 468	20650	81	22350	84	23416	86	23999	85
09421	177	09655	179	15220	193	17730	161, 468	20700	81	22380	84	23417	86	24000	92
09422	177	09656	179	15240	193	17733	161, 468	20800	81	22381	84	23418	86	24060	90
09425	177	09900	166	15291	205	18000	202	20850	81	22430	85	23419	86	24070	90
09427	177	09903	166	15292	205	18001	202	20900	81	22431	85	23420	86	24080	90
09429	177	09910	166	15301	205	18002	202	21000	81	22460	84	23421	86	24100	137
09430	177	09920	179	16000	205	18020	203	21100	81	22465	85	23422	86	24112	137
09445	175	09930	179	16001	205	18021	203	21200	81	22466	85	23423	86	24113	136
09446	175	09950	179	16002	205	18180	90	21250	81	22500	85	23424	86	24120	137
09457	180	10000	359	16012	204	18200	198	21300	81	22550	92	23460	88	24122	137
09459	180	10001	359	16030	152	18201	198	21400	81	22551	92	23585	87	24130	137
09462	179	10002	359	16280	204	18250	198	21600	81	22565	88	23586	87	24140	137
09463	179	10003	359	16300	204	18300	198	21650	82	22570	88	23590	86	24295	92
09465	358	10010	359	16301	204	18350	198	21680	83	22571	88	23591	86	24300	90
09466	358	10011	359	16340	204	18355	199	21682	83	22572	88	23592	87	24310	90
09467	358	10012	359	16360	204	18356	199	21684	83	22610	82	23593	87	24320	90
09470	180, 358	10013	359	16380	204	18357	199	21686	83	22611	82	23594	87	24330	90
09471	180, 358	10014	359	16400	204	18360	198	21688	83	22612	83	23601	86	24340	90
09472	180, 358	10015	360	16551	205	18361	198	21690	83	22613	83	23602	86	24350	90
09473	359	10061	191	16552	205	18362	198	21691	83	22616	83	23603	86	24370	90
09474	359	10062	191	16553	205	18370	199	21692	83	22617	83	23604	86	24390	90
09475	180, 357	10063	191	16554	205	18372	199	21695	83	22640	83	23605	87	24410	90
09476	180, 357	10064	191	16555	205	18374	199	21700	89	23311	84	23606	87	24430	90
09477	180, 357	10065	191	16556	205	18375	199	21701	89	23312	84	23608	87	24450	90
09478	180, 357	10101	191	16557	205	18377	200	21702	89	23313	84	23620	85	24470	90
09480	358, 467	10104	191	17300	197	18380	198	21703	89	23314	84	23640	85	24500	91
09481	358, 467	10106	191	17301	197	18381	198	21704	89	23315	84	23650	85	24510	91
09482	358, 467	10109	191	17302	197	18382	198	21705	89	23316	84	23660	85	24520	91
09483	358, 467	10111	191	17303	197	18390	198	21706	89	23317	84	23670	85	24530	91
09484	358, 467	10122	191	17304	197	18470	200	21709	90	23318	84	23680	85	24550	91
09486	358	10123	191	17310	198	18473	199	21900	82	23325	84	23690	85	24570	91
09487	358	10125	191	17430	196	18501	199	21905	82	23326	84	23692	85	24590	91
09489	358	10128	191	17435	196	18502	199	21910	82	23327	84	23693	85	24610	91
09490	359	10129	191	17470	146, 195	18503	199	21915	82	23329	84	23694	85	24630	91
09521	177	10130	191	17471	146, 195	18504	199	21919	82	23331	84	23710	85	24650	91
09522	177	10133	191	17473	146, 195	18530	200	21921	82	23371	86	23720	85	24670	91
09523	177	10135	191	17474	146, 195	18790	200	21924	82	23372	86	23722	85	24700	91
09524	177	10138	191	17480	146, 195	18797	199	21927	82	23373	86	23723	85	24710	91
09525	177	10139	191	17481	146, 195	18798	199	21929	82	23374	86	23724	85	24730	91
09531	178	12100	191	17483	146, 195	18799	199	21932	82	23375	86	23730	85	24740	91

No.	Page	No.	Page	No.	Page	No.	Page	No.	Page	No.	Page	No.	Page	No.	Page
24750	91	25886	113	28720	89	30450	62	33026	68, 432	35015	185	35757	438	35839	440
24800	92	25887	114	28725	89	30460	62	33028	68, 432	35017	185	35758	438	35840	440
24810	92	26130	115	28733	89	30480	62	33030	68, 432	35018	185	35759	438	35842	441
24813	92	26131	115	28740	99, 430	30500	62	33032	68, 432	35020	186	35760	445	35843	437
24820	92	26132	115	28745	99, 431	30510	62	33035	68, 432	35021	186	35761	438	35846	440
24823	92	26140	115	28746	99, 431	30520	62	33038	68, 432	35025	186	35762	438	35850	440
24900	91	26150	117	28750	99, 430	30531	62	33039	68, 432	35026	186	35763	442	35855	437
24940	91	26200	117	28755	99, 431	30532	62	33040	68, 432	35030	186	35764	443	35860	441
24960	91	26210	117	28771	99, 431	30533	62	33065	68, 431	35031	186	35765	434	35861	437
24961	91	26220	117	28772	99, 431	30534	62	33067	68, 431	35032	186	35767	434	35863	438
24962	91	26225	117, 279	28773	99, 431	30535	62	33080	68, 431	35033	186	35768	434	35864	441
24963	91	27000	99	28790	101	30536	62	33085	68, 431	35060	186	35770	443	35865	441
24964	91	27100	100	28880	150	31010	62	33087	68, 431	35061	187	35773	443	35867	355
24965	91	27200	100	29000	101	31030	62	33105	68, 431	35062	187	35774	443	35868	355
24966	91	27322	100	29050	101	31050	62	33107	68, 431	35063	187	35775	445	35869	355
25160	114	27333	100	29090	103	31070	62	33125	68, 431	35064	187	35776	443	35870	355
25161	114	27495	100	29100	103	31100	62	33127	68, 431	35210	111	35777	443	35872	355
25162	114	27500	102	29210	101	31150	62	33147	68, 431	35240	111	35779	442	35874	355
25163	114	27501	102	29220	101	31200	62	33177	68, 431	35250	66	35780	442	35875	355
25164	114	27502	102	29311	101	31300	62	33530	65	35300	66	35781	442	35876	355
25165	114	27505	102	29312	101	31400	62	33532	65, 291	35351	66	35782	442	35877	355
25166	114	27506	102	29313	101	31500	62	33535	64	35352	66	35783	442	35890	441
25170	115	27510	102	29317	102	31600	62	33550	64	35353	66	35784	442	35891	441
25171	116	27511	103	29318	102	31800	62	33555	64	35355	66	35785	442	35892	442
25172	116	27513	103	29319	102	32000	62	33557	64	35359	66	35786	444	35893	356, 446
25173	116	27520	103	29323	102	32110	63, 291	33650	64	35360	66	35787	444	35894	356, 446
25230	116	27530	103	29400	162	32201	63	33655	64	35362	66	35788	443	35895	356, 446
25300	116	27533	103	29401	162	32202	63	33657	64	35364	66	35789	443	35899	356, 446
25301	116	27575	94	29404	162	32203	63	33900	64	35366	66	35790	444	35905	356, 446
25307	116	27600	100	29410	162	32204	63	33905	64	35368	66	35791	444	35906	357, 446
25310	117	27610	100	29420	225	32205	63	33907	64	35372	66	35792	443	35908	357, 446
25351	115	27800	103	29440	162	32206	63	33925	64	35373	66	35793	445	35911	356, 445
25352	115	27810	104	29444	163	32207	63	33950	65, 291	35374	66	35794	445	35912	356, 445
25353	115	27811	104	29445	163	32208	63	34182	232	35376	66	35795	445	35914	356
25360	115	27812	104	29992	63	32625	63	34184	232	35430	66	35797	438	35915	356
25370	115	27813	104	29993	63	32627	64	34204	67	35450	66	35798	442	35916	356
25380	115	27814	104	29994	63	32685	63	34205	67	35451	66	35799	438	35918	356
25390	115	27815	104	29995	63	32687	64	34206	67	35452	66	35800	439	35923	356
25400	280	27820	104	29996	63	32705	64	34207	67	35600	183, 466	35801	439	35924	356
25405	92, 281	27830	104	29997	63	32715	64	34208	67	35608	465	35802	439	35927	356, 446
25410	280	27831	104	30010	62	32720	63	34210	67	35610	465	35803	439	35930	354
25411	281	27832	104	30020	62	32900	70	34212	67	35611	465	35805	440	35931	354
25412	281	27833	104	30030	62	32901	70	34220	67	35623	469	35806	440	35932	354
25420	120	27834	104	30040	62	32902	70	34222	67	35624	469	35807	440	35933	354
25450	280	27850	102	30050	62	32922	70, 433	34225	67	35625	469	35808	440	35940	354
25500	65	28000	99, 168	30060	62	32923	70, 433	34243	67	35670	439	35809	436	35950	357, 446
25510	65	28010	99, 168	30080	62	32924	69, 432	34245	67	35671	439	35810	436	35960	354
25511	65	28011	99, 168	30100	62	32925	69, 432	34247	67	35673	442	35811	436	35961	354
25512	65	28012	99, 168	30150	62	32926	69, 432	34251	67	35677	439	35813	441	35962	354
25513	65	28380	98	30200	62	32927	69, 432	34254	67	35680	439	35815	441	35963	355
25514	65	28381	98	30310	62	32928	69, 432	34256	67	35685	439	35816	441	35964	355
25515	65	28382	98	30320	62	32930	68, 431	34300	67	35700	443	35817	438	35968	355
25516	65	28385	98	30330	62	32999	69, 432	34600	67	35701	438	35821	447	35970	355
25517	65	28386	98	30340	62	33000	68, 432	34750	67	35705	438	35823	447	35971	355
25518	65	28387	98	30350	62	33001	68, 432	34900	67	35710	445	35824	447	36000	76
25519	65	28394	98	30360	62	33002	68, 432	34944	172	35720	436	35826	447	36004	76
25520	65	28395	98	30380	62	33003	68, 432	34945	172	35721	437	35828	447	36005	76
25521	65	28640	430	30390	62	33004	68, 432	34946	172	35722	437	35830	447	36006	76
25530	65	28641	430	30395	62	33005	68, 432	34947	172	35740	442	35831	447	36008	76
25700	65	28642	430	30400	62	33006	68, 432	34949	469	35741	442	35832	447	36014	76
25830	113	28650	99	30410	62	33007	68, 432	34950	184	35750	444	35833	437	36015	76
25860	113	28680	89	30420	62	33008	68, 432	35010	185	35751	444	35835	437	36016	76
25881	113	28690	89	30430	62	33022	69, 432	35012	185	35755	444	35836	436	36018	76
25885	113	28710	89	30440	62	33024	68, 432	35013	185	35756	438	35837	437	36032	77

No.	Page	No.	Page	No.	Page	No.	Page	No.	Page	No.	Page	No.	Page	No.	Page
36033	77	40010	46	44500	51, 291	50560	10	51689	9	53410	16	54750	12	56624	41
36034	77	40011	46	45000	56	50580	10	51690	9	53420	16	54760	12	56625	41
36037	77	40012	46	45010	57	50590	10	51691	9	53430	16	54780	12	56626	41
36038	77	40013	46	45012	56	50610	10	51692	9	53440	16	55100	52, 125	56627	41
36039	77	40014	46	45020	57	50630	10	51693	9	53450	16	55150	52, 125	56628	41
36570	77, 124	40015	46	45050	56	50850	8	51694	9	53460	16	55200	52, 125	56629	41
36650	76	40016	46	45100	57	50861	8	51695	9	53470	16	55210	52, 125	56630	41
37100	74	40017	46	45151	57	50871	8	51696	9	53480	16	55211	52, 125	56631	41
37101	74	40018	46	45160	57	50880	9	51705	9	53490	16	55212	52, 125	56632	41
37102	74	40041	46	45201	57	51040	8	51710	9	53500	17	55215	52, 125	56633	41
37103	74	40042	46	45500	56	51042	8	51715	10	53520	17	55216	52, 125	56634	41
37104	74	40043	46	45503	56	51044	8	51720	9	53540	17	55217	52, 125	56635	41
37106	74	40044	46	45504	56	51046	8	51721	9	53560	17	55220	52, 125	56636	41
37107	74	40045	46	48000	96, 292	51047	8	51722	9	53561	17	55221	52, 125	56637	41
37108	74	40047	46	48050	97, 293	51048	8	51740	11	53562	17	55222	52, 125	56638	41
37109	74	40048	46	48060	96, 292	51049	8	51741	11	53563	17	55250	52, 124	56639	41
37110	74	40050	46	48070	97, 293	51051	8	52580	11	53571	17	55300	52, 124	56640	41
37111	74	40051	46	48080	96, 292	51060	8	52630	11	53572	17	55350	52, 124	56641	41
37112	74	40054	47	48081	97, 293	51070	8	52652	10	53573	17	55500	129, 364, 527	56642	41
37113	74	40055	47	48082	97, 292	51080	8	52653	10	53575	17	55505	129, 364, 527	56643	41
37114	74	40056	47	48100	96, 292	51090	8	52654	10	53576	17	55541	129, 364, 527	56644	41
37115	74	40057	47	48150	97, 293	51100	8	52655	10	53577	17	55542	129, 364, 527	56645	41
37150	74	40160	48	48200	97, 293	51110	8	52656	10	53580	18	55544	129, 364, 527	56646	41
37200	74	40180	48	48330	97, 293	51120	8	52657	10	53600	16	55545	129, 364, 527	56647	41
37250	74	40200	48	48350	98	51130	8	52658	10	53610	16	55620	52, 124	56648	41
37300	74	40700	48	49200	97	51140	8	52659	10	53630	16	55625	52, 124	56649	41
37380	74	41121	47	49450	98	51150	8	52660	10	53650	16	55630	52, 124	56710	11
37400	74	41151	47	49600	98	51160	8	52661	10	53670	16	55635	52, 124	56720	11
37430	74	41152	47	49770	98	51170	8	52680	11	53700	17	55645	52, 124	56730	11
37500	74	41381	47	49771	98	51180	8	52700	11	53710	17	55660	52, 124	56770	11
37800	74	41500	47	49772	98	51190	8	52730	11	53730	17	55690	52, 124	56780	11
37900	74	41510	51, 124	49773	98	51200	8	52740	11	54000	12	55740	126	56790	11
38150	74	42300	48	49774	98	51210	8	52750	11	54061	12	55792	53, 125	56980	232
38200	74	42301	48	49775	98	51220	8	52770	11	54062	12	55820	124	57000	233
38401	74	42302	49	49780	184	51240	8	52790	11	54063	12	55830	124	57010	233
38402	74	42303	48	49781	184	51270	8	52820	11	54065	12	56040	42	57020	233
38403	74	42304	49	49782	184	51300	8	52900	11	54066	12	56050	42	57030	233
38404	74	42305	48, 49	49785	184	51320	8	52935	12	54067	12	56060	42	57050	233
38406	74	42306	49	49786	184	51560	8	52936	12	54068	12	56070	42	57091	236, 265
38407	74	42307	49	49787	184	51580	8	53002	16	54070	13	56080	42	57092	236, 265
38408	74	42308	49	49790	184	51590	8	53003	16	54071	13	56100	42	57097	236, 265
38409	74	42309	49	49791	184	51620	8	53100	16	54072	13	56120	42	57100	233
38430	76	43050	49	49792	184	51630	8	53120	16	54073	13	56130	42	57160	233
38431	76	43051	50	49800	185	51640	8	53130	16	54080	13	56140	42	57210	233
38432	76	43052	50	49801	185	51645	8	53140	16	54081	13	56170	42	57220	234
38433	76	43053	50	49802	185	51650	8	53150	16	54497	53, 125	56380	42	57221	234
38434	76	43055	49	49805	185	51671	9	53160	16	54498	53, 125	56390	42	57260	234
38435	76	43056	50	49806	185	51672	9	53170	16	54499	53, 125	56391	42	57300	13
38436	76	43057	50	49810	184	51673	9	53180	16	54500	53, 125	56392	42	57350	13
38500	75	43058	50	49830	184	51674	9	53190	16	54510	53, 125	56393	42	57400	13
38515	75	43060	49	49840	135	51675	9	53220	16	54600	12	56400	42	57450	13
38525	75	43061	50	49841	135	51676	9	53240	16	54610	12	56470	42	57451	13
38531	75	43062	50	50070	10	51677	9	53270	16	54620	12	56473	42	57600	229
38620	75	43063	50	50090	10	51678	9	53300	16	54630	12	56475	43	57610	230
38641	75	43510	50	50100	10	51679	9	53320	16	54640	12	56477	43	57612	230
38642	75	43600	112	50110	10	51680	9	53332	16	54650	12	56478	43	57613	230
38643	75	43603	112	50120	10	51681	9	53335	16	54660	12	56505	43, 315	57614	230
38750	75	44100	50	50130	10	51682	9	53336	16	54670	12	56506	43, 315	57616	231
38751	75	44102	50	50150	10	51683	9	53337	16	54680	12	56507	43, 315	57620	230
38830	76	44110	50	50170	10	51684	9	53338	16	54690	12	56600	43	57630	230
39000	244	44300	51, 291	50190	10	51685	9	53339	16	54700	12	56620	41	57640	230
39001	244	44301	51, 291	50220	10	51686	9	53340	16	54710	12	56621	41	57650	230
39002	244	44330	51, 292	50270	10	51687	9	53341	16	54720	12	56622	41	57660	230
39005	244	44400	51, 291	50330	10	51688	9	53400	16	54730	12	56623	41	57700	234

No.	Page	No.	Page	No.	Page	No.	Page	No.	Page	No.	Page	No.	Page	No.	Page
57730	234	60933	26	62166	28	65472	37	67163	353	67810	318	69307	516	69552	147, 197
57830	224	60934	26	62167	28	65475	37	67164	353	67811	319	69308	516	69572	146, 196
58140	19	60935	26	62170	28	65476	37	67165	353	67840	321	69311	516	69608	147, 197
58150	19	60936	26	62171	28	65477	37	67166	353	67841	322	69312	516	69609	147, 197
58160	18	60937	26	62172	28	65480	36	67171	357	67877	334	69313	516	69610	147, 197
58210	18	60938	26	62173	28	65481	36	67180	341	67880	334	69314	516	69612	147, 197
58240	18	60939	26	62174	28	65482	36	67181	341	67881	334	69315	516	69613	147, 197
58260	18	60950	26	62175	28	65483	36	67182	341	67882	334	69316	516	69620	146, 196
58440	223	60951	26	62176	28	65501	37	67183	341	67883	335	69317	517	69621	146, 196
58441	223	60952	26	62177	28	65502	37	67200	339	67884	335	69318	517	69630	146, 196
58450	224	60953	26	62178	28	65503	37	67201	339	67885	335	69319	517	69631	146, 196
58455	224	60954	26	64050	34	65504	37	67202	339	67887	335	69320	517	69635	147, 196
58456	224	60955	26	64060	34	65505	37	67203	340	67888	335	69321	517	69637	147, 196
58539	223	60956	26	64070	34	65700	38	67204	340	67889	335	69330	517	69851	470
58540	221	60957	26	64090	34	65705	38	67220	340	67890	335	69331	517	69860	470
58550	222	60958	26	64310	35	65800	38	67221	340	67900	322	69332	517	70000	132
58570	220	60959	26	64330	35	65840	40	67222	340	67901	322	69333	518	70020	132
58600	18	60961	26	64370	35	65850	40	67223	340	67950	318	69334	518	70023	132
58602	18	60962	26	64371	35	66080	40	67224	340	67961	318	69337	518	70030	132
58633	19	60963	26	64384	36	66112	40	67225	341	68011	333	69338	518	70035	132
58634	19	60964	26	64385	32	66113	40	67231	342	68012	333	69339	518	70100	132
58640	19	60965	26	64395	36	66200	40	67260	179, 357, 458	68090	342	69340	518	70160	133
58641	19	60966	26	64396	36	66210	40	67420	332	68100	342	69341	518	70201	133
58643	20	60967	26	64400	35	66301	38	67451	331	68115	342	69344	518	70202	133
58661	20	60968	26	64401	35	66302	38	67453	332	68116	342	69345	519	70210	133
58685	20	60969	26	64402	31	66310	38	67455	332	68172	322	69346	519	70270	133
58687	20	60970	26	64553	36	66330	38	67456	331	68173	323	69347	519	70280	134, 216
58688	21	60975	28	64554	36	66400	39	67457	332	68174	323	69348	519	70320	133
58690	21	60990	27	64555	36, 232	66410	39	67458	331	68193	323	69350	519	70330	133
58691	22	61010	28	64650	33	66570	39	67470	333	68194	323	69351	519	70340	133
58693	23	61020	28	64654	30	66580	39	67480	333	68195	324	69352	519	70400	133
58700	22	61030	28	64655	31	66710	39	67481	334	68250	336	69353	519	70410	133
60750	28	61040	28	64658	31	66720	39	67500	328	68251	336	69354	520	70420	133
60780	27	61050	28	64660	32	66760	39	67501	329	68260	337	69370	520	70430	133
60781	27	61060	28	64952	30	66770	40	67520	330	68269	328	69371	520	70480	133
60782	27	61070	28	64960	30	66900	343	67521	330	68270	327	69372	520	70490	133
60783	27	61080	28	65015	31	66901	343	67523	329	68271	327	69373	520	70500	133
60785	27	61090	28	65025	32	66902	343	67524	329	68272	327	69374	520	70510	133
60880	26	61110	29	65033	32	66903	343	67525	330	68273	327	69375	520	71000	134
60881	26	61120	29	65034	31	66904	343	67526	329	68360	335	69376	520	71040	134
60882	26	61140	29	65035	30	66906	343	67527	331	68361	335	69377	521	71050	134
60883	26	61150	29	65041	30	66930	344	67530	330	68362	336	69378	521	71052	134
60884	26	61160	29	65045	33	66931	344	67570	324	68363	336	69390	501	71060	135
60885	26	61210	29	65046	33	66932	344	67571	325	68364	336	69391	501	71080	135
60886	26	61220	29	65100	34	66933	344	67572	325	68365	336	69395	500	71160	135
60887	26	61230	29	65105	31	66936	344	67573	325	68500	324	69396	500	71800	510
60888	26	61240	29	65120	32	66937	345	67574	325	68510	324	69397	500	71801	510
60889	26	61250	29	65123	33	66940	345	67590	326	68621	514	69502	146, 196	71802	510
60890	26	61260	29	65124	33	66950	345	67640	326	68622	515	69503	146, 196	71803	510
60891	26	61270	29	65150	34	66955	345	67641	326	68623	515	69504	146, 196	71804	510
60912	26	61280	29	65233	58	66956	345	67642	326	68800	522	69505	146, 196	71805	510
60913	26	61290	29	65235	58	67090	337	67660	328	68801	523	69506	146, 196	71807	510
60914	26	61300	29	65260	234	67091	337	67661	328	68820	523	69507	146, 196	71808	510
60915	26	61320	29	65270	235	67093	337	67700	320	68830	523	69508	146, 196	71809	510
60916	26	61340	29	65451	37	67094	338	67701	320	68831	523	69509	146, 196	71810	510
60917	26	61350	29	65452	37	67095	338	67702	320	68832	523	69510	146, 196	71811	510
60918	26	61360	29	65453	37	67110	338	67703	320	68833	523	69521	146, 195	71812	510
60920	26	61550	30	65454	37	67112	338	67705	321	69203	524	69539	147, 197	71814	510
60921	26	62160	28	65456	37	67115	339	67709	321	69204	524	69540	147, 197	71815	510
60922	26	62161	28	65457	37	67116	339	67710	321	69205	524	69542	147, 197	71816	510
60923	26	62162	28	65458	37	67120	339	67780	319	69301	515	69543	147, 197	71817	510
60924	26	62163	28	65461	37	67160	352	67781	319	69302	515	69546	147, 197	71818	510
60931	26	62164	28	65470	37	67161	353	67790	319	69305	515	69550	147, 197	71819	510
60932	26	62165	28	65471	37	67162	353	67805	318	69306	515	69551	147, 197	71820	510

No.	Page	No.	Page	No.	Page	No.	Page	No.	Page	No.	Page	No.	Page	No.	Page
71821	510	72080	135	72631	395	72976	351	73571	140	73931	388, 457	74135	379, 456	74541	382
71822	510	72100	135	72632	395	72977	352	73572	140	73932	388, 457	74136	379, 457	74542	383
71823	510	72120	135	72683	390	72978	352	73573	140	73933	388, 457	74137	379, 457	74543	383
71824	510	72140	135	72684	390	72979	352	73574	140	73934	388, 457	74145	380	74555	383
71825	510	72350	394	72685	390	72981	352	73575	140	73935	388, 457	74146	380	74580	387, 461
71827	511	72351	394	72686	390	72984	352	73590	140	73936	388, 457	74148	381	74581	387, 461
71828	511	72352	394	72801	389	72985	352	73598	141	73937	388, 458	74149	381	74595	387, 460
71829	511	72353	394	72802	389	72994	350	73780	141	73938	388, 458	74150	380	74600	386, 459
71830	511	72354	394	72803	389	72995	350	73781	141	73939	388, 458	74151	380	74601	387, 459
71831	511	72355	394	72804	389	72996	350	73782	141	73940	388, 458	74160	380	74602	387, 459
71832	511	72356	394	72805	389	72997	350	73783	141	73941	388, 458	74162	380	74603	387, 459
71833	511	72357	394	72806	389	72998	350	73784	141	73942	388, 458	74171	388, 460	74604	387, 459
71834	511	72358	394	72807	389	73021	350	73785	141	73943	388, 458	74172	388, 460	74610	386, 459
71835	511	72370	394	72808	389	73022	350	73786	141	73945	388, 458	74173	388, 460	74622	386, 459
71836	511	72371	394	72809	389	73025	350	73787	141	73946	388, 458	74174	388, 460	74624	386, 459
71837	511	72372	394	72821	389	73026	350	73788	141	73947	388, 458	74175	388, 460	74626	390
71838	511	72373	394	72822	389	73027	350	73789	141	73950	388, 458	74176	388, 460	74627	390
71840	511	72400	397	72823	389	73031	351	73790	141	73951	388, 458	74190	388, 460	74628	390
71841	511	72401	397	72824	389	73032	351	73791	141	73952	388, 458	74191	388, 460	74631	390
71842	511	72402	397	72825	389	73033	351	73792	141	73953	388, 458	74192	388, 460	74632	390
71843	511	72404	397	72826	389	73034	351	73793	141	73954	388, 458	74193	388, 460	74633	390
71844	511	72407	397	72827	389	73035	351	73794	141	73955	388, 458	74194	388, 460	74646	391
71846	511	72451	396	72828	389	73051	271	73795	141	73958	389, 458	74195	388, 460	74647	391
71847	511	72452	396	72829	389	73052	267	73796	141	73959	389, 458	74225	402	74653	390
71848	511	72460	394	72890	389	73056	267	73797	141	73960	389, 458	74226	402	74654	390
71849	511	72484	395	72891	389	73057	267	73798	141	73961	389, 458	74227	402	74655	390
71850	511	72486	395	72920	361	73060	271	73799	141	73962	389, 458	74410	288, 383	74657	391
71851	511	72489	395	72922	363	73260	142, 281	73800	141	73963	389, 458	74411	288, 383	74658	391
71852	511	72490	395	72928	362	73270	142, 281	73801	141	73964	389, 458	74420	288	74659	391
71853	511	72493	395	72931	363	73271	142, 281	73802	141	73966	389, 458	74421	288	74660	390
71854	511	72494	395	72932	364	73300	142, 281	73803	141	73967	389, 458	74422	288	74661	390
71855	511	72500	394	72933	349	73325	159	73804	141	73968	389, 458	74430	288	74662	390
71856	511	72501	394	72934	349	73330	159	73805	141	73969	389, 458	74431	288	74663	390
71857	511	72504	394	72935	349	73331	159	73806	141	73970	389, 458	74432	288	74664	390
71858	511	72505	394	72936	349	73340	159	73807	141	73971	389, 458	74439	290, 386	74665	390
71859	511	72506	394	72937	349	73341	159	73808	141	73972	389, 458	74440	288, 383	74666	390
71860	511	72508	394	72938	350	73342	160	73831	140	73973	389, 458	74441	289, 384	74667	390
71970	136	72509	394	72939	350	73343	160	73833	140	74003	381	74442	288, 383	74721	366
71971	136	72510	394	72942	351	73350	160	73835	140	74060	381	74443	289, 383	74722	366
71972	136	72524	395	72943	351	73351	160	73840	142	74077	380	74447	289, 384	74723	366
71975	136	72525	395	72944	351	73352	160	73843	142	74078	380	74448	289, 384	74724	366
71976	136	72526	395	72945	351	73353	160	73845	142	74079	380	74450	289, 384	74730	372
71977	136	72527	395	72948	350	73360	160	73850	142	74080	380	74451	290, 386	74731	372
71978	136	72528	395	72950	350	73362	160	73853	142	74081	381	74452	290, 386	74732	372
71980	136	72529	395	72951	350	73400	128, 158	73855	142	74082	381	74453	290, 386	74733	373
71981	136	72530	395	72952	350	73403	128, 158	73875	142	74094	378	74454	290, 386	74734	373
71982	136	72531	395	72953	350	73404	128, 158	73881	141	74100	378, 456	74455	290, 386	74740	373
71983	136	72532	395	72954	350	73410	127, 158	73882	141	74102	378	74457	289, 384	74741	373
71990	136	72533	395	72955	349	73412	127, 159	73883	141	74104	378	74459	381	74744	373
71991	136	72534	395	72956	351	73413	127, 159	73884	141	74106	378	74460	381	74750	373
71992	136	72535	395	72958	351	73420	127, 158	73885	141	74108	378	74462	385, 460	74751	373
71993	136	72570	396	72960	351	73430	160	73886	141	74113	379, 457	74466	386	74752	373
71994	136	72572	396	72963	351	73470	279	73887	141	74115	379, 457	74468	385, 460	74753	374
71995	136	72573	396	72964	351	73473	279	73888	141	74117	379, 457	74471	385, 460	74765	374
71996	136	72615	395	72965	351	73500	281	73892	141	74121	379, 457	74480	290, 384	74766	374
71997	136	72616	395	72966	351	73503	205	73893	141	74123	379, 457	74483	290, 385	74771	374
72000	136	72617	395	72967	351	73561	140	73894	141	74125	378, 456	74484	290, 385	74772	374
72001	136	72620	395	72968	351	73562	140	73895	141	74126	379, 456	74501	382, 461	74773	374
72010	136	72621	395	72969	351	73563	140	73896	141	74127	379, 456	74503	382, 461	74775	374
72011	136	72622	395	72970	351	73565	140	73897	141	74128	379, 457	74504	382, 461	74776	374
72012	136	72625	395	72972	349	73567	140	73898	141	74130	378, 456	74505	382, 461	74777	375
72013	136	72626	395	72973	349	73568	140	73906	141	74131	378, 456	74508	382, 461	74780	498
72040	135	72627	395	72974	351	73569	140	73909	141	74132	379, 456	74509	382, 461	74781	498
72060	135	72630	395	72975	352	73570	140	73929	141	74134	379, 456	74540	382	74782	499

74783	499	75125	143, 180	75371	502	75622	507	75765	491	75979	514	76832	282	77845	301, 313
74784	499	75130	143, 181	75372	502	75623	507	75767	492	75980	512	76835	283	77850	302, 313
74785	499	75131	143, 181	75373	502	75624	507	75768	492	75981	513	76836	283	77861	302, 313
74786	499	75132	143, 181	75374	502	75625	506	75775	496	75982	513	76850	282	77881	302, 313
74787	499	75133	143, 181	75375	502	75626	506	75776	496	75983	514	76851	282	77900	300
74788	499	75140	144, 181	75376	502	75627	505	75777	496	75984	514	76852	282	77910	300
74789	499	75141	144, 181	75377	502	75628	506	75778	496	76000	109	76853	282	77930	300
74790	500	75200	128	75378	502	75629	505	75779	496	76010	109	76854	282	78000	227
74791	500	75201	128	75379	502	75631	506	75801	484	76011	109	76855	282	78001	228
74792	500	75202	128	75380	502	75632	506	75802	484	76015	109	76856	282	78002	228
74793	500	75230	144	75381	503	75633	506	75803	484	76101	109	76857	282	78003	228
74794	500	75231	144	75382	503	75634	506	75804	484	76160	109	76858	282	78007	228
74802	369	75233	144	75383	503	75635	506	75805	486	76180	110	76859	282	78020	364
74804	369	75238	144, 181	75384	503	75636	507	75806	486	76181	110	76870	283	78021	364
74812	369	75239	144, 181	75386	503	75639	507	75807	486	76182	110	76877	283	78022	364
74816	370	75240	144, 181	75387	503	75645	509	75808	487	76183	110	76880	283	78027	142
74818	370	75245	143, 181	75388	503	75646	509	75809	487	76184	109	76881	283	78030	228
74820	370	75246	143, 181	75389	503	75647	509	75811	487	76185	110	76882	283	78031	228
74828	370	75247	143, 181	75421	503	75648	509	75812	487	76186	110	76883	283	78032	229
74831	370	75260	143, 181	75422	503	75649	509	75813	487	76190	110	76884	283	78035	229
74833	370	75261	143, 181	75423	503	75650	509	75814	487	76210	111	77004	297	78037	227
74835	370	75262	143, 181	75424	503	75651	509	75815	488	76214	110	77005	297	78039	227
74838	370	75270	143, 180	75448	503	75652	510	75816	488	76220	111	77006	297	78040	226
74841	370	75271	143, 180	75449	503	75653	510	75817	488	76230	111	77061	297	78041	226
74843	370	75272	143, 180	75450	503	75654	510	75818	488	76250	111	77062	297	78042	226
74846	370	75273	143, 180	75451	503	75655	510	75827	488	76305	112	77063	297	78043	227
74849	370	75274	143, 180	75455	522	75660	512	75828	488	76311	112	77064	297	78044	229
74851	371	75285	143, 180	75464	522	75662	485	75829	489	76312	112	77100	298	78045	227
74853	371	75286	143, 180	75465	521	75663	485	75830	490	76314	112	77105	298	78046	226
74855	371	75287	143, 180	75467	521	75664	485	75831	490	76320	58	77170	299	78047	226
74856	371	75288	143, 180	75468	521	75665	485	75832	490	76526	108	77180	299	78061	227
74858	370	75295	142	75469	521	75670	497	75833	490	76621	108	77190	299	78067	227
74861	371	75300	143, 182	75470	522	75671	498	75834	489	76622	108	77191	299	78068	227
74863	371	75301	142, 182	75471	522	75672	498	75835	489	76640	108	77192	299	78101	261
74866	371	75302	142, 182	75472	522	75673	498	75836	489	76650	108	77193	299	78102	262
74869	371	75303	143, 182	75483	504	75674	498	75837	489	76660	109	77200	299	78106	262
74882	371	75304	143, 182	75484	504	75675	497	75838	489	76700	113	77203	299	78116	262
74885	371	75327	503	75487	504	75676	497	75870	486	76705	113	77204	299	78124	262
74886	371	75334	503	75498	504	75677	497	75871	486	76710	113	77205	299	78154	264
74887	371	75335	503	75499	504	75678	497	75880	493	76750	369	77210	298	78300	229
74910	371	75336	503	75527	508	75679	497	75881	493	76751	369	77211	298	78301	229
74911	371	75345	501	75535	508	75705	494	75882	493	76752	369	77212	298	78303	229
74912	371	75346	501	75536	508	75706	494	75883	493	76755	369	77213	298	78306	229
74913	371	75347	501	75537	508	75707	495	75884	493	76756	369	77250	298	78341	126
74914	371	75348	501	75539	508	75708	495	75885	493	76757	369	77300	298	78381	126
74920	372	75349	501	75540	504	75709	495	75886	494	76760	369	77350	298	78385	126
74921	372	75350	501	75541	505	75710	495	75887	494	76761	369	77400	298	78388	126
74922	372	75351	501	75544	505	75711	495	75888	494	76762	369	77500	298	78400	235
74923	372	75352	501	75545	505	75712	495	75889	494	76765	369	77600	298	78401	235
74924	372	75353	501	75550	505	75716	485	75915	372, 524	76766	369	77607	298	78405	235, 401
75000	144	75354	501	75551	505	75718	485	75916	372, 525	76767	369	77700	298	78410	235
75012	145	75355	501	75553	509	75719	486	75921	526	76800	282	77704	299	78432	296
75028	145	75356	501	75554	509	75729	496	75922	526	76806	282	77705	299	78434	296
75031	145, 182	75360	502	75555	512	75740	490	75923	527	76807	282	77715	315	78436	296
75035	145	75361	502	75556	512	75742	490	75924	527	76810	282	77795	315	78464	300
75036	145	75362	502	75558	512	75743	491	75930	526	76811	282	77815	301, 313	78465	300
75050	144	75363	502	75559	512	75745	492	75931	526	76814	282	77830	301, 312	78466	300
75060	144	75364	502	75564	508	75747	492	75932	526	76815	282	77831	301, 312	78470	300
75100	144, 181	75365	502	75565	508	75748	492	75944	525	76818	282	77833	301, 312	78471	300
75120	143, 180	75366	502	75578	509	75749	492	75945	525	76819	282	77834	301, 312	78472	300
75121	143, 180	75367	502	75579	509	75760	491	75951	525	76822	282	77835	301, 312	78477	224
75122	143, 180	75368	502	75619	507	75762	491	75953	525	76823	282	77837	301, 312	78540	348
75123	143, 180	75369	502	75620	507	75763	491	75977	513	76826	282	77838	301, 312	78541	348
75124	143, 180	75370	502	75621	507	75764	491	75978	513	76830	282	77840	301, 313	78542	348

No.	Page	No.	Page	No.	Page	No.	Page	No.	Page	No.	Page	No.	Page	No.	Page
78543	348	78826	309	79442	274, 453	79979	284	81117	209	81783	58, 190	82392	251	82772	397
78555	348	78830	309	79448	274, 453	79982	284	81118	210	81784	58, 190	82393	251	82830	403
78556	348	78831	309	79467	274, 452	79983	284	81119	210	81785	203	82395	251	82831	403
78557	348	78833	309	79468	276, 454	79984	284	81122	211	81786	203	82397	251	82832	403
78570	348	78834	309	79491	266	80012	239	81133	210	81790	201	82400	251	82845	397
78571	348	78835	309	79500	272, 452	80022	239	81137	209	81791	202	82401	251	82846	397
78572	348	78855	268	79501	272, 452	80032	239	81142	211	81794	202	82402	251	82847	398
78575	348	78870	362	79550	276, 454	80042	239	81150	209	81795	202	82403	251	82848	398
78576	348	78890	271	79551	276, 454	80052	239	81370	215	81801	59, 191	82404	251	82910	246
78577	348	78894	270	79552	276, 454	80062	239	81371	215	81824	235	82405	251	82920	246
78580	348	78910	127, 268	79570	278	80072	239	81372	215	81825	236	82406	251	82941	281
78581	348	78911	126, 271	79580	279	80082	239	81373	215	81830	223	82407	251	82942	270
78582	348	78912	127, 268	79630	279	80111	240	81374	215	82000	243, 314	82408	251	82951	247, 362
78585	348	78972	264	79639	280	80252	240	81378	215	82001	243, 314	82409	251	82952	247, 362
78586	348	78974	264	79640	280	80271	240	81379	215	82005	243, 314	82410	251	82953	247, 362
78587	348	78981	263	79641	280	80300	240	81380	215	82015	243, 314	82411	251	82954	248, 363
78590	349	78982	263	79675	274, 453	80307	240	81387	216	82020	243, 314	82412	251	82955	247, 362
78591	349	78983	263	79725	274, 453	80308	240	81390	215	82021	243, 314	82413	251	82967	248, 363
78592	349	78985	263	79771	272, 421	80309	240	81391	215	82022	243, 315	82414	251	82970	248, 363
78620	296	78986	263	79772	272, 421	80312	240	81399	216	82031	314	82415	251	82971	248, 363
78622	296	78987	263	79773	272, 421	80320	241	81400	216	82032	314	82431	246	82991	248, 470
78624	296	78992	260	79774	272, 421	80330	241	81401	216	82105	244	82440	245	82992	248, 470
78626	297	78995	260	79775	272, 421	80340	241	81490	215	82107	244	82445	246	83000	246
78628	297	78997	260	79781	269, 421	80350	241	81491	215	82200	244	82502	246	83001	246
78630	297	79013	260	79782	269, 421	80402	241	81492	215	82201	244	82504	246	83002	247
78632	297	79049	260	79783	269, 421	80412	241	81500	215	82205	244	82506	246	83004	247
78633	297	79053	261	79790	272, 421	80450	241	81501	215	82206	245	82520	246	83005	247
78641	296	79054	261	79791	272, 421	80470	231	81502	215	82209	244	82541	241	83009	228
78642	296	79087	264	79792	272, 421	80471	231	81519	215	82225	245	82542	242	83120	404
78660	365	79088	264	79800	279	80472	231	81520	215	82227	245	82543	242	83121	404
78661	365	79089	264	79810	273, 422	80473	231	81521	215	82231	245	82544	242	83122	404
78662	365	79090	261	79811	273, 422	80474	231	81522	215	82232	245	82610	242	83123	404
78663	365	79124	265	79812	273, 422	80500	231	81523	215	82233	245	82611	242	83124	404
78700	306	79125	270	79861	453	80510	231	81524	215	82234	245	82650	242	83260	249
78710	306	79254	266	79862	453	80520	231	81525	215	82260	252	82671	396, 471	83261	249
78720	306	79257	266	79863	453	80530	231	81527	215	82261	252	82673	396, 471	83262	249
78730	306	79309	266	79865	453	80600	231	81553	214	82262	252	82675	396, 471	83266	249
78731	225, 306	79314	270	79866	453	80601	231	81556	214	82300	249	82677	396	83267	249
78734	225, 307	79320	266	79867	453	80602	232	81560	214	82301	249	82682	396	83280	249
78736	225, 307	79324	270	79869	453	80620	232	81562	214	82305	250	82684	396	84400	203
78738	226, 307	79325	270	79880	273, 422	80640	232	81570	214	82308	250	82685	396	85000	252
78750	306	79327	267	79881	273, 421	80660	233	81617	212	82310	250	82691	396	85001	252
78751	306	79328	267	79909	269, 420	80661	233	81618	212	82315	250	82692	396	85002	252
78752	306	79346	280	79919	278	80701	231	81631	213	82320	250	82693	396	85003	252
78756	235	79350	276	79924	278	80751	243	81632	213	82322	252	82694	396	85004	252
78771	308	79354	268	79926	273, 422	80752	243	81633	213	82331	250	82699	237, 399	85005	252
78785	308	79355	271	79927	273, 422	80753	243	81634	214	82341	250	82706	237, 399	85020	253, 360
78790	308	79358	276	79928	273, 422	80901	212	81638	213	82343	251	82713	237, 399	85030	253, 360
78791	309	79365	267	79929	273, 422	80902	212	81640	213	82351	251	82714	237, 399	85040	253, 360
78793	308	79366	267	79930	273, 422	80903	212	81643	213	82355	76	82715	237, 399	85050	253, 360
78794	309	79367	267	79931	274, 422	80970	209	81644	213	82360	250	82716	238, 399	85060	253, 360
78800	307	79368	267	79932	274, 422	81060	211	81647	214	82370	250	82717	238, 399	85080	253, 360
78801	307	79377	268	79933	274, 422	81070	210	81650	211	82372	250	82719	236, 398	85090	253, 360
78802	307	79378	268	79943	269, 421	81072	210	81651	211	82373	250	82723	237, 398	85100	253, 360
78811	308	79382	271	79944	273, 421	81073	211	81653	212	82374	250	82724	238, 400	85112	253, 360
78812	308	79383	271	79960	419	81080	210	81661	212	82375	250	82726	239, 400	85113	253, 360
78813	308	79385	271	79962	419	81100	208	81690	234	82377	250	82728	236, 398	85114	253, 360
78814	308	79386	281	79963	419	81101	208	81731	204, 234	82378	250	82730	238, 400	85115	253, 360
78815	308	79390	283	79965	419	81107	208	81741	242	82379	250	82731	238, 400	85116	253, 360
78819	309	79391	283	79968	419	81108	208	81751	203	82380	250	82733	238, 400	85118	253, 360
78821	309	79393	268	79971	419	81109	208	81773	59, 190	82384	250	82734	238, 399	85119	253, 360
78822	309	79396	268	79973	419	81110	208	81774	59, 190	82386	250	82735	239, 400	85120	253, 360
78824	309	79398	282	79977	284	81114	209	81775	59, 190	82388	250	82756	239, 401	85122	252, 360
78825	309	79416	266	79978	284	81115	209	81780	58, 190	82390	250	82771	397	85123	252, 360

No.	Page	No.	Page	No.	Page	No.	Page	No.	Page	No.	Page	No.	Page	No.	Page
85124	252, 360	87383	368	88870	424	89214	413	89315	418	89472	278, 455	90240	466	99404	447
85125	252, 360	87384	368	88871	424	89215	414	89316	418	89473	278, 456	99001	429	99405	449
85126	252, 360	87391	368	88930	424	89218	415	89318	418	89474	278, 456	99005	429	99406	449
85128	252, 360	87392	368	88931	424	89220	414	89319	418	89475	278, 456	99006	429	99407	448
85129	252, 360	87393	368	88932	425	89221	408	89320	418	89478	278, 456	99007	430	99408	447
85130	252, 360	87401	368	88933	425	89222	408	89330	419	89479	278, 456	99008	430	99409	448
85131	252, 360	87402	368	88935	425	89223	408	89331	419	89480	278, 456	99009	430	99410	447
85132	252, 360	87403	368	88936	425	89224	408	89335	420	89481	278, 456	99028	436	99412	449
85133	252, 360	87411	368	88938	425	89225	408	89336	420	89482	278, 456	99033	435	99413	449
85134	252, 360	87412	368	88939	425	89226	408	89345	420	89483	278, 456	99034	434	99415	448
85135	252, 360	87413	368	89000	465	89227	408	89348	420	89484	278, 456	99035	434	99416	448
85170	253, 360	87431	368	89001	408	89228	408	89351	415	89485	278, 456	99036	434	99418	448
85172	253, 361	87432	368	89002	408	89229	409	89360	419	89486	278, 456	99037	435	99419	448
85174	253, 361	87433	368	89003	408	89230	409	89361	419	89507	450	99038	435	99420	448
85177	253, 361	87435	368	89004	408	89231	409	89370	419	89508	450	99039	435	99421	448
85178	253, 361	87437	368	89007	409	89232	409	89371	419	89509	450	99040	435	99425	449
85180	253, 361	87451	368	89008	409	89233	409	89372	419	89515	450	99047	433	99426	449
85185	254, 361	87452	368	89011	409	89234	409	89373	419	89518	450	99048	433	99427	449
85190	254, 361	87453	368	89013	410	89235	410	89380	419	89520	450	99049	434	99428	449
85191	254, 361	87454	368	89015	410	89236	410	89381	419	89526	450	99050	433	99429	449
86700	365	87455	368	89017	411	89239	410	89382	419	89528	450	99051	433	99430	449
86701	365	87456	368	89018	411	89240	410	89383	419	89536	451	99052	434	99435	449
86750	128	87457	368	89020	411	89241	411	89384	419	89537	451	99053	435	99436	449
86751	128	88421	312, 403	89022	412	89242	411	89385	419	89538	451	99054	435	99438	449
86752	128	88422	312, 403	89081	462	89243	412	89386	419	89539	451	99056	436	99440	449
86760	129	88555	239, 401	89100	408	89244	412	89387	419	89540	451	99101	427	99442	449
86761	128	88560	239, 401	89101	408	89245	411	89390	415	89541	451	99103	428	99443	449
86770	129	88670	402	89102	408	89246	411	89401	276, 454	89542	452	99104	428	99444	449
86771	129	88672	402	89103	408	89247	412	89402	276, 454	89543	452	99109	428	99445	449
87245	366	88673	402	89104	409	89248	412	89403	276, 454	89545	452	99110	429	99446	449
87301	366	88674	402	89105	409	89251	411	89404	276, 454	89547	452	99111	428	99460	69, 433
87302	366	88675	402	89106	410	89252	411	89405	276, 454	89552	420	99112	429	99461	69, 433
87303	366	88676	402	89107	410	89253	409	89406	276, 454	89553	420	99113	428	99462	69, 433
87305	366	88677	401	89108	411	89257	416	89411	277, 454	89560	183, 466	99114	428	99463	69, 433
87307	366	88678	401	89109	411	89259	416	89412	277, 454	89561	183, 466	99115	429	99464	69, 433
87311	367	88700	463	89110	410	89260	416	89413	277, 454	89562	183, 466	99116	428	99472	69, 433
87312	367	88701	463	89112	412	89261	416	89414	277, 454	89563	183, 466	99119	428	99483	478
87313	367	88702	463	89113	411	89263	416	89415	277, 454	89564	183, 466	99180	427	99495	475
87315	367	88703	463	89120	413	89265	416	89416	277, 454	89610	272, 450	99181	427	99512	474
87317	367	88704	463	89162	417	89269	416	89421	277, 455	89611	272, 451	99182	427	99513	473
87321	367	88705	463	89163	417	89271	417	89422	277, 455	89700	462	99190	426	99514	475
87322	367	88720	436	89164	417	89272	416	89423	277, 455	89702	462	99191	427	99524	479
87323	367	88740	463	89165	417	89275	417	89424	277, 455	89704	462	99193	425	99528	357, 446, 481
87325	367	88780	422	89166	418	89277	417	89425	277, 455	89715	462	99194	425	99533	474
87327	367	88783	422	89167	418	89280	417	89426	277, 455	89720	462	99195	427	99568	481
87331	367	88784	423	89187	413	89290	418	89441	277, 454	89722	462	99202	426	99575	481
87332	367	88801	463	89189	413	89291	418	89442	277, 454	89750	464	99203	426	99576	481
87333	367	88805	463	89190	414	89292	418	89443	277, 454	89753	464	99204	426	99580	476
87335	367	88806	463	89191	414	89293	418	89444	277, 454	89770	464	99206	426	99581	476
87337	367	88809	463	89192	414	89294	418	89452	277, 455	89860	469	99207	427	99582	476
87351	367	88811	463	89193	413	89295	418	89453	277, 455	89870	469	99208	426	99583	477
87352	367	88812	463	89195	414	89298	418	89454	277, 455	89880	435	99209	426	99584	475
87353	367	88820	464	89200	413	89299	418	89456	277, 455	89896	467	99230	426	99585	477
87354	367	88850	423	89201	412	89300	418	89457	277, 455	89950	470	99240	427	99586	474
87361	367	88853	423	89202	412	89302	418	89458	277, 455	89990	470	99300	430	99587	473
87362	367	88855	423	89203	415	89303	418	89459	277, 455	90000	464	99301	430	99588	474
87363	367	88856	423	89204	415	89305	418	89462	277, 455	90001	464	99310	429	99589	476
87364	367	88857	423	89206	415	89307	418	89463	277, 455	90002	464	99315	429	99591	477
87371	367	88858	423	89207	415	89308	418	89464	277, 455	90003	465	99390	444	99592	477
87372	367	88860	423	89208	415	89310	418	89465	278, 455	90030	465	99391	444	99593	478
87373	367	88861	424	89209	414	89311	418	89466	278, 455	90031	465	99400	443	99594	475
87374	367	88862	424	89210	413	89312	418	89467	278, 455	90150	465	99401	444	99595	478
87381	368	88863	424	89211	414	89313	418	89470	278, 455	90200	466	99402	447	99633	478
87382	368	88864	424	89213	413	89314	418	89471	278, 455	90204	466	99403	447	99642	472

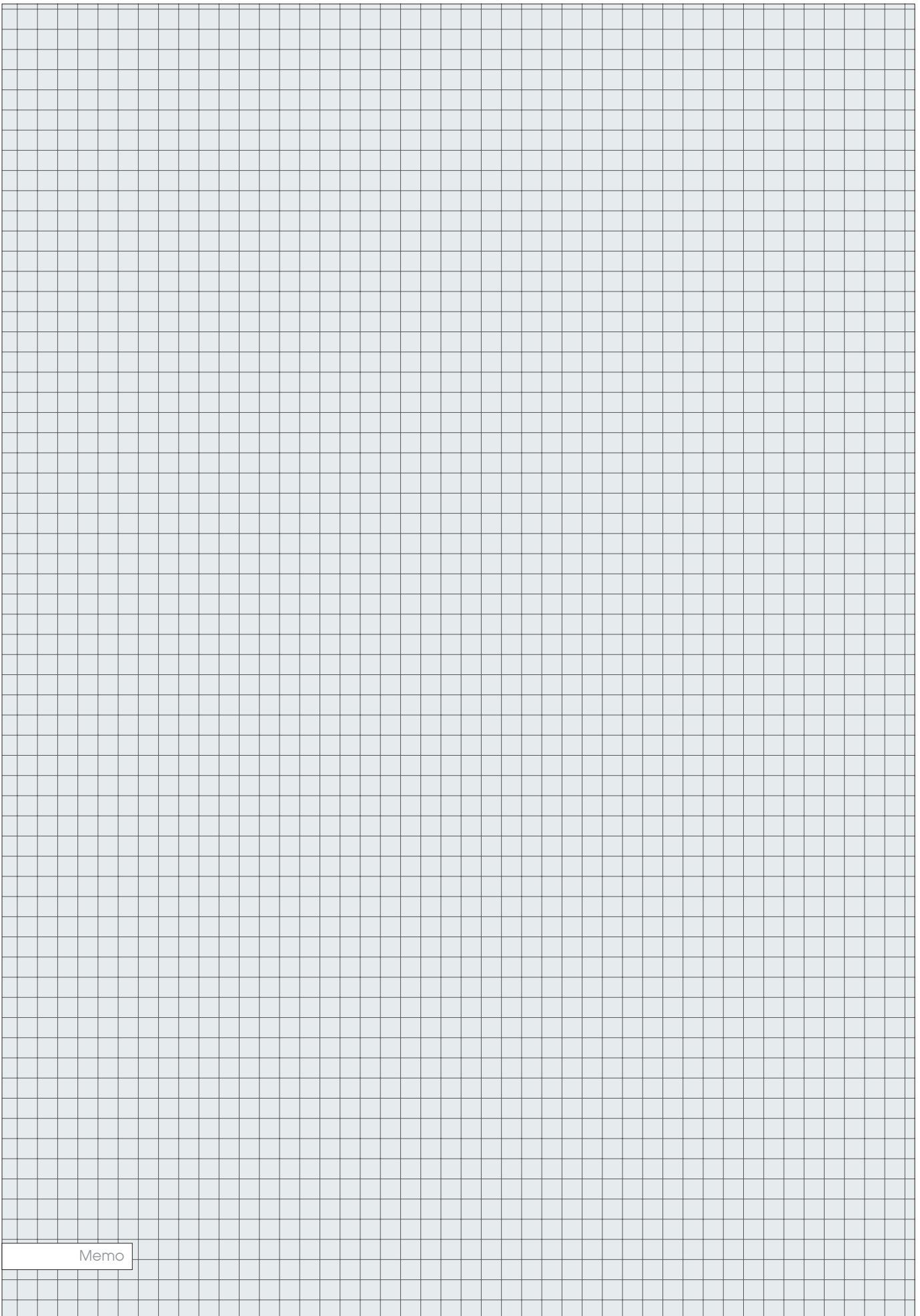

Memo

Memo

PL

I. TOYA S.A. informuje, iż:

- 1) niniejszy katalog nie stanowi oferty w rozumieniu prawa cywilnego;
- 2) prezentowane w niniejszym katalogu artykuły mogą w rzeczywistości odbiegać od wskazanego na zdjęciach wzoru, w szczególności jeżeli chodzi o cechy zewnętrzne, tj. wielkość, kolor, sposób opakowania, ilość przedmiotów w opakowaniu;
- 3) nie ponosi odpowiedzialności za drobne różnice w sposobie pakowania czy właściwościach artykułów pozostających bez wpływu na jego przeznaczony cel lub sposób użytkowania;
- 4) nie ponosi odpowiedzialności wynikającej z jakichkolwiek niedokładności lub nieścisłości, co do informacji zawartych w przedmiotowym katalogu;
- 5) nie ponosi odpowiedzialności za ewentualną szkodę powstałą w wyniku otrzymania towaru o innych właściwościach niż prezentowany na zdjęciach.

II. Pomimo najlepszych starań poczynionych przez TOYA S.A. nie może ona zagwarantować, iż informacje zawarte w niniejszym katalogu w pełni odpowiadają rzeczywistości.

III. Wszelkie decyzje podjęte na podstawie informacji zawartych w przedmiotowym katalogu podejmowane są na własne ryzyko osoby, która korzysta z tych informacji.

GB

I. TOYA S.A. informs that:

- 1) the present catalogue does not constitute an offer as construed in the civil law;
- 2) the goods presented in the present catalogue may in fact differ from the models shown in the pictures, particularly as far as external properties are concerned, namely size, colour, packaging, number of items in the package;
- 3) the company will not be held responsible for small differences in packaging or properties of the goods, which do not affect the purpose or the exploitation of the tools;
- 4) the company will not be held responsible for any inaccuracies or imprecision regarding the information presented in the catalogue;
- 5) the company will not be held responsible for any damage caused by goods whose properties differ from those of the tools presented in the photographs.

II. In spite of all the efforts made by TOYA S.A., the company cannot guarantee the information contained in the present catalogue fully correspond to the reality.

III. Any decisions made on the basis of the information contained in the present catalogue will be made at the risk of the person who makes them using the aforementioned information.

D

I. TOYA S.A. informiert, dass:

- 1) der vorliegende Katalog kein Angebot im zivilrechtlichen Sinne darstellt;
- 2) die im vorliegenden Katalog präsentierten Artikel in der Realität von den auf den Musterfotos gezeigten abweichen können, und zwar besonders dann, wenn es um äußere Eigenschaften geht, wie z.B. Größe, Farbe, Art der Verpackung, Anzahl der Gegenstände in der Verpackung;
- 3) sie keine Verantwortung für geringfügige Unterschiede bei der Verpackungsart oder den Eigenschaften der Artikel übernimmt, die ohne Auswirkungen auf seinen Bestimmungszweck oder die Art der Nutzung bleiben;
- 4) sie keine Verantwortung für irgendwelche Oberflächlichkeiten und Ungenauigkeiten bzgl. der im Sachkatalog enthaltene Informationen übernimmt;
- 5) sie keine Verantwortung für eventuelle Schäden, die im Ergebnis des Erhalts der Ware mit anderen als auf den Fotos dargestellten Eigenschaften entstanden sind, übernimmt.

II. Trotz großer Bemühungen seitens TOYA S.A. kann die Firma nicht garantieren, dass die im vorliegenden Katalog enthaltenen Informationen voll der Realität entsprechen.

III. Sämtliche Entscheidungen, die auf der Grundlage der im Sachkatalog enthaltenen Informationen getroffen wurden, gehen auf das Risiko der Person, die diese Informationen benutzt.

RUS

I. TOYA S.A. заявляет:

- 1) настоящий каталог не является торговым предложением с точки зрения гражданского законодательства;
- 2) изделия, представленные в настоящем каталоге, могут отличаться от образцов на снимках, особенно внешним видом, то есть размером, цветом, способом упаковки, количеством предметов в упаковке;
- 3) производитель не отвечает за мелкие отличия в способе упаковки или свойствах изделий, которые не влияют на предназначение или способ пользования изделиями;
- 4) производитель не отвечает за мелкие неточности в сведениях из предметного каталога;
- 5) производитель не отвечает за ущерб, нанесенный вследствие поставки товара, отличающегося параметрами от указанного на снимках.

II. Несмотря на все усилия в данном направлении, компания TOYA S.A. не гарантирует, что информация, метящаяся в настоящем каталоге, полностью отвечает действительности.

III. Риск, связанный с любыми решениями, принятыми на основании информации из предметного каталога, берут на себя лица, пользующиеся указанной информацией.

UA

I. Інформація від виробника, TOYA S.A.:

- 1) цей каталог не є комерційною пропозицією з точки зору цивільного законодавства;
- 2) виробі, представлені в цьому каталозі, можуть відрізнятися від зображень на фотографіях, особливо зовнішнім виглядом, тобто розміром, кольором, способом упаковки, кількістю предметів в упаковці;
- 3) виробник не несе відповідальність за дрібні відмінності у способі упаковки чи властивостях виробів, які не мають впливу на їх призначення чи спосіб користування ними;
- 4) виробник не несе відповідальність за дрібні неточності у інформації, включеної у цей каталог;
- 5) виробник не несе відповідальність за можливі збитки, нанесені внаслідок отримання виробів, що своїми параметрами відрізняються від зображень на фотографіях.

II. Незважаючи на зусилля у даному напрямку, фірма TOYA S.A. не гарантує, що інформація, включена у цей каталог, повністю відповідає дійсності.

III. Приймаючи будь-які рішення на підставі інформації, включеної у цей каталог, не забувайте, що пов'язаний з ними ризик беруть на себе особи, що використовують включену у каталог інформацію.

LT

I. TOYA S.A. informuoja, kad:

- 1) šis katalogas nėra civilinės teisės supratimu pasiūlymas;
- 2) rodomos šame kataloge prekės gali tikrumoje skirtis nuo parodyto nuotraukose pavyzdžio, ypač jų išorine išvaizda ir požymiais, t.y. dydžiu, spalva, įpakavimo būdu, elementų kiekiu pakuotėje;
- 3) gamintojas neneša atsakomybės už nereikšmingus skirtumus įpakavime arba gaminio savybėse, kurios neturi įtakos jo paskirčiai arba jo varojimo būdui.
- 4) neneša taip pat atsakomybės dėl bet kokių netikslumų arba nepakankamai preciziškų apibrėžimų pateiktoje kataloge informacijoje.
- 5) neneša atsakomybės už galimai patirtus nuostolius gavus prekę su savybėmis, kurios nėra tapačios su pateiktomis nuotraukose.

II. Nežiūrint geriausių TOYA S.A. pastangų, bendrovė negali garantuoti, kad pateikta šiame kataloge informacija pilnai atitinka tikrovę.

III. Bet kokie sprendimai priimami šiame kataloge pateiktą informaciją pagrindu yra besinaudojančio šia informacija asmens priimami savo paties rizika.

LV

I. A/S „TOYA“ informē, ka:

- 1) šis katalogs nav piedāvājums civillikuma izpratnē;
- 2) piedāvāti šī katalogā produkti realitātē var atšķirties no rādīta uz fotogrāfijas parauga, sevišķi ārēju īpašību sfērā, t.i. ar lielumu, krāsu, pakošanas veidu, priekšmetu skaitu iepakojumā;
- 3) nav atbildīga par smalkām atšķirībām iepakošanas veidā vai produktu īpašībām, ja tie neietekmē ierīces paredzētu mērķu vai lietošanas veidu;
- 4) nav atbildīga par kaut kādām neprecizitātēm informācijās, kas ir norādītas šī katalogā;
- 5) nav atbildīga par iespējamiem zaudējumiem, savienotiem ar produkta saņemšanu ar citām īpašībām, nekā rādītas uz fotogrāfijas.

II. Neskatoties uz visaugstāko rūpību, ar kuru A/S „TOYA“ sagatavoja savu katalogu, tā nevar garantēt, ka informācijas šī katalogā pilnīgi atbild realitātei.

III. Visi lēmumi, pieņemti pamatojoties uz informācijas no kataloga - ir pieņemti uz personas, kura lieto šo informāciju, risku.

CZ

I. TOYA S.A. informuje že:

- 1) tento katalog nepředstavuje nabídku ve smyslu občanského práva;
- 2) výrobky prezentované v tomto katalogu se mohou ve skutečnosti lišit od modelů uvedených na obrázcích, zejména co se týká vnějších znaků, tj. velikosti, barvy, způsobu balení, počtu předmětů v balení;
- 3) nenesse odpovědnost za drobné rozdíly ve způsobu balení nebo ve vlastnostech výrobků, které nemají zásadní vliv na jejich určený účel nebo způsob používání;
- 4) nenesse odpovědnost vyplývající z jakýchkoli nepřesností co do informací uvedených v předmětném katalogu;
- 5) nenesse odpovědnost za případné škody vzniklé v důsledku obdržení zboží s jinými vlastnostmi, než je uvedeno na obrázcích.

II. Navzdory mimořádnému úsilí vynaloženému firmou TOYA S.A. tato nemůže garantovat, zda informace uvedené v tomto katalogu zcela odpovídají skutečnosti.

III. Veškerá rozhodnutí přijatá na základě informací uvedených v předmětném katalogu jsou přijímána na vlastní riziko osoby, která tyto informace využívá.

SK

I. TOYA S.A. informuje že:

- 1) tento katalóg nepredstavuje ponuku v zmysel občianskeho práva;

- 2) výrobky prezentované v tomto katalógu sa v skutočnosti môžu líšiť od modelov zobrazených na obrázkoch, najmä pokiaľ sa jedná o vonkajšie znaky, t.j. veľkosť, farbu, spôsob balenia, počet predmetov v balení;
- 3) nenesie zodpovednosť za drobné rozdiely v spôsobe balenia či vlastnostiach výrobkov, ktoré nemajú zásadný vplyv na ich určený účel alebo spôsob používania;
- 4) nenesie zodpovednosť vyplývajúcu z akejkoľvek nepresnosti týkajúcej sa informácií uvedených v predmetnom katalógu;
- 5) nenesie zodpovednosť za prípadné škody vzniknuté v dôsledku obdržania tovaru s inými vlastnosťami, než je uvedené na obrázkoch.

II. Aj napriek mimoriadnemu úsilíu zo strany firmy TOYA S.A. táto nemôže garantovať, či informácie uvedené v tomto katalógu plne zodpovedajú skutočnosti.

III. Všetky rozhodnutia prijaté na základe informácií uvedených v predmetnom katalógu sú prijímané na vlastné riziko osoby, ktorá tieto informácie využíva.

H

I. A TOYA S.A. tájékoztatja, hogy:

- 1) a jelen katalógus a polgári jog szerinti nem kereskedelmi ajánlat;
- 2) a jelen katalógusban bemutatott árucikkek a valóságban eltérhetnek a képeken látható mintától, különösen a külső tulajdonságok, mint a méret, szín, csomagolási mód, a csomagban lévő tárgyak száma tekintetében;
- 3) nem vállal felelősséget a csomagolás módjában vagy az árucikkek olyan tulajdonságaiban történt változtatásokért, amelyek nem befolyásolják lényeges módon annak rendeltetését vagy a felhasználás módját;
- 4) nem vállal felelősséget a jelen katalógusban lévő információk pontatlanságáért;
- 5) nem vállal felelősséget azokért az esetleges károkért, amik az árucikkek a fényképeken látható tulajdonságoktól eltérő tulajdonságokkal történő leszállításból erednek.

II. A TOYA S.A. minden igyekezete ellenére nem tudja garantálni, hogy a jelen katalógusban

található információk teljes egészében megfelelnek a valóságnak.

III. A tárgyi katalógusban található információk alapján meghozott bármilyen döntés annak a személynek a rizikója, aki ezeket az információkat felhasználja.

RO

I. TOYA S.A. informează că:

- 1) prezentul catalog nu constituie ofertă în înțelesul dreptului civil;
- 2) articolele prezentate în prezentul catalog se pot diferi față de mostrele din fotografiile, în special aspectul exterior, adică mărimea, culoarea, modul de ambalare, cantitatea obiectelor în ambalaj;
- 3) nu-și asumă răspunderea referitor la mici diferențe la modul de ambalare sau la articole al căror proprietăți nu au influență referitor la destinația sau modul lor de utilizare;
- 4) nu-și asumă răspunderea referitor la orice inexactitate sau imprecizie, datorită informațiilor cuprinse în catalogul respectiv;
- 5) nu-și asumă răspunderea referitor la o eventuală pagubă ca urmare primirii marfei cu alte proprietăți decât cele prezentate pe fotografii;

II. Cu toate strădanile TOYA S.A., firma nu poate garanta că, informațiile din prezentul catalog corespund realității;

III. Orice decizie preluată în baza informațiilor cuprinse în catalogul respectiv, sunt preluate pe riscul și răspunderea persoanei care a făcut folos de aceste informații.

E

I. TOYA S.A. comunica lo siguiente:

- 1) el presente catálogo no constituye una oferta, en el sentido que la noción adquiere en la ley civil;
 - 2) los artículos presentados en el presente catálogo pueden en realidad diferir de los modelos indicados en las fotografías, especialmente en cuanto a sus propiedades externas, es decir el tamaño, el color, el empaque o la cantidad de los objetos en el empaque;
 - 3) la empresa no se hace responsable por pequeñas diferencias en cuanto al empaque o las propiedades de los artículos, siempre y cuando estas diferencias no afectan el propósito o el modo de operación de las herramientas;
 - 4) la empresa no se hace responsable por ninguna imprecisión en cuanto a la información presentada en el presente catálogo;
 - 5) la empresa no se hace responsable por ningún daño que surja del hecho de que los artículos recibidos difieran de los artículos presentados en las fotografías en cuanto a sus propiedades.
- II. A pesar de los mejores intentos de parte TOYA S.A. la empresa no puede garantizar que la información presentada en el presente catálogo corresponda completamente a la realidad.
- III. Todas las decisiones tomadas en base a la información presentada en el presente son responsabilidad de la persona que recurra a la dicha información.

Memo



REG-707
Branded rack YATO 100 cm /
Regał firmowy YATO 100 cm



REG-777
Hangers set for power tools YATO /
Zestaw zawieszni na elektronarzędzia YATO



REG-779
Hangers set for power tools YATO 18 V /
Zestaw zawieszni na elektronarzędzia YATO 18 V



REG-918
Display for sanding paper YATO in rolls /
Ekspozytor na papier ścierny YATO w rolkach

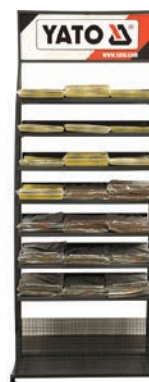

REG-919
Display for sanding paper YATO in sheets /
Ekspozytor na papier ścierny YATO w arkuszach



REG-908
Standing display for YATO rectifiers /
Ekspozytor stojący na prostownik YATO



REG-925
Display for YATO work clothes /
Ekspozytor na ubrania robocze YATO



REG-603
Rotary display rack YATO /
Ekspozytor obrotowy YATO



REG-776
Standing triangular display for YATO sets /
Trójstronny ekspozytor stojący na zestawy YATO



REG-763
Standing display for YATO shoes /
Ekspozytor stojący na buty YATO



REG-977
Chrome tube mannequin /
Manekin z rury chromowej



REG-764
Standing display for YATO levels /
Ekspozytor stojący na poziomie YATO



REG-708
Branded rack VOREL 100 cm /
Regał firmowy VOREL 100 cm



REG-999
Standing display for window seals VOREL /
Ekspozytor stojący na uszczelki na okien VOREL



REG-954
Display for ropes / Ekspozytor na liny



REG-706
Branded rack STHOR 100 cm /
Regał firmowy STHOR 100 cm



REG-709
Branded rack FLO 100 cm /
Regał firmowy FLO 100 cm

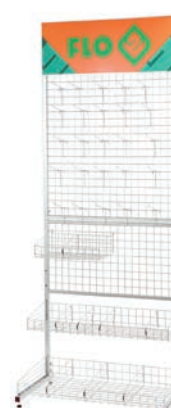

REG-715
Mesh display rack FLO 230 cm /
Regał siatkowy FLO 230 cm



REG-147
Kitchen faucet display rack FALA /
Ekspozytor na baterie kuchenne FALA



REG-146
Bath faucet display rack FALA /
Ekspozytor na baterie łazienkowe FALA



REG-149
Stand for linear drains FALA /
Ekspozytor na odpływy liniowe FALA



REG-808
Display for wave toilet seats FALA /
Ekspozytor na deski toaletowe FALA



REG-992
Display rack for REG-707 for pipe wrenches YATO /
Ekspozytor do REG-707 na klucze do rur YATO

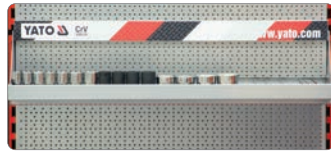

REG-994
Display rack for REG-707 for YATO bits /
Ekspozytor do REG-707 na nasadki YATO



REG-994P
Display rack with the lid for REG-707 for YATO bits /
Ekspozytor z pokrywą do REG-707 na nasadki YATO



REG-998
Display rack for REG-707 for YATO hammers /
Ekspozytor do REG-707 na młotki YATO



REG-993
Display rack for REG-707 for YATO pneumatic tools /
Ekspozytor do REG-707 na narzędzia pneumatyczne YATO



REG-951
Display for carpentry clamps /
Ekspozytor na ściiski stolarskie



REG-804
Tag for YATO shoes / Zawieszka na buty YATO



REG-991
Display rack for REG-707 for YATO disc saws /
Ekspozytor do REG-707 na płyty tarczowe YATO



REG-952
Display for the disc for disc cutters /
Ekspozytor na tarcze do szlifierek kątowych



REG-761
Hook for axes / Wieszak na siekiery



REG-930
Display for YATO buck saws /
Ekspozytor na piły kabłąkowe YATO



REG-909
Display stand for FLO garden tools /
Ekspozytor na narzędzia ogrodowe FLO



REG-868
Hook 30 cm for trowels / Hak 30 cm na kielnie



REG-144
Pendant for wall mounted faucet FALA /
Zawieszka na baterię ścienną FALA



REG-145
Pendant for deck mounted faucet FALA /
Zawieszka na baterię stojącą FALA



REG-911
Pallet display for garden tools /
Ekspozytor paletowy na narzędzia ogrodnicze



REG-799
Display stand VOREL /
Display ekspozycyjny VOREL



REG-902
Standing display for YATO sockets /
Ekspozytor stojący na nasadki YATO



REG-807
Display box for STHOR drill bits /
Ekspozytor skrzynka na wiertła STHOR



REG-604
Wall-stand display rack YATO /
Ekspozytor stojąco-wiszący YATO



REG-605
Waterfall display rack YATO /
Ekspozytor kaskadowy YATO







REG-705
Advertising wobler YATO /
Wobler reklamowy YATO



REG-803
YATO wrench tester /
Tester kluczy YATO



REG-711
Rack shelf for REG-707 YATO /
Półka do REG-707 YATO

	Colour box		Sleeve
	Box with colour label		Carton envelope
	PVC colour box		Bulk
	Box		Plastic holder
	Display colour box		Flag tied on card
	Hanging colour box		Metal box
	Blister card		Metal box with colour label
	Double blister card		Metal box with sleeve
	Double blister transparent		Plastic box
	Half double blister card		Plastic box with colour sleeve
	Sliding card		Plastic case with colour label
	Plastic hanger		Plastic case with label
	Hanging card		Plastic case with colour sleeve
	Header card		Plastic tube with colour label
	Tied on card		Metal clip
	Skin card		Wooden box with sleeve
	Polybag with header card		Pouch
	Polybag		Shrink card / Plastic tray
	Printed polybag		
	Polybag with hanger		

FALA linear drains create unlimited possibilities for arranging your bathroom!
 Odpływy liniowe FALA stwarzają nieograniczone możliwości w aranżacji Twojej łazienki!



INOX
 STAINLESS
 STEEL

White Glass
75381 – 60 cm
75382 – 70 cm
75383 – 80 cm
75384 – 90 cm

Black Glass
75386 – 60 cm
75387 – 70 cm
75388 – 80 cm
75389 – 90 cm

Olimp
75421 – 60 cm
75422 – 70 cm
75423 – 80 cm
75424 – 90 cm

Line
75448 – 60 cm
75449 – 70 cm
75450 – 80 cm
75451 – 90 cm



It can prevent stink and worms both in use and after dry.
 Zapobiega przedostawaniu się zapachów oraz robaków podczas używania, jak i po wysuszeniu.

WET&DRY

Efficient and durable screen prevents siphon trap from clogging up.
 Skuteczne i trwałe sito zapobiega zapychaniu syfonu.

STRAINER

Easy cleaning due to a hook included in the delivery.
 Łatwe do utrzymania w czystości dzięki dołączonemu haczykowi.

EASYclean

Top-quality precise welded joints warrant drain tightness.
 Wysokiej jakości precyzyjne spawy gwarantują szczelność odpływu.

HQwelding

Holders stabilising the body. Additional rigidity through structure supports.
 Uchwyty stabilizujące korpus. Dodatkowe usztywnienie konstrukcji w podłodze.

GRIPstrong

Low siphon trap, made of AISI 304 stainless steel, easy to install.
 Niski syfon wykonany ze stali nierdzewnej AISI 304 ułatwia instalację.

EXTRASlim

Sealing mat included in delivery – necessary in case hydroisolation is to be applied.
 Mata uszczelniająca w zestawie – niezbędna część przy wykonywaniu hydroizolacji.

HYDRocloth

Extensive height regulation which enables the drain to be adjusted against the floor level.
 Szeroki zakres regulacji wysokości umożliwia dopasowanie odpływu do powierzchni posadzki.

EASYfix



MANUFACTURER / PRODUCENT

TOYA S.A.
ul. Soltysowicka 13-15
51-168 Wrocław
☎ (+48 71) 32 46 200
fax: (+48 71) 32 46 370

sales@yato.pl (sale)
export@yato.pl (export)
import@yato.pl (import)

ODDZIAŁ WARSZAWSKI
Teren ProLogis Park Nadarzyn
al. Kasztanowa 160
05-831 Młochów k. Warszawy

☎ (+48 22) 73 82 800
☎ (+48 22) 73 82 828
sales@yato.pl (sale)
export@yato.pl (export)

TOYA ROMANIA S.A.
Șos. Ștefănești, 8 - 8A,
Ștefănești De Jos, Ilfov
☎ (+40 031) 710 8692
office@yato.ro

YATO TOOLS (SHANGHAI) CO.,LTD.
No. 1, Lane 1300, East Kangqiao Road
Shanghai, China 201315
☎ (+86 21) 681 829 50
fax: (+86 21) 681 829 51
yato@yato-sh.com

YATO TOOLS (JIAXING) CO.,LTD
Room. 239, No. 8 Baibu Avenue, Baibu Town,
Haiyan County, Jiaxing City, Zhejiang Province, China
☎ (+86 21) 681 829 50
yato@yato-sh.com

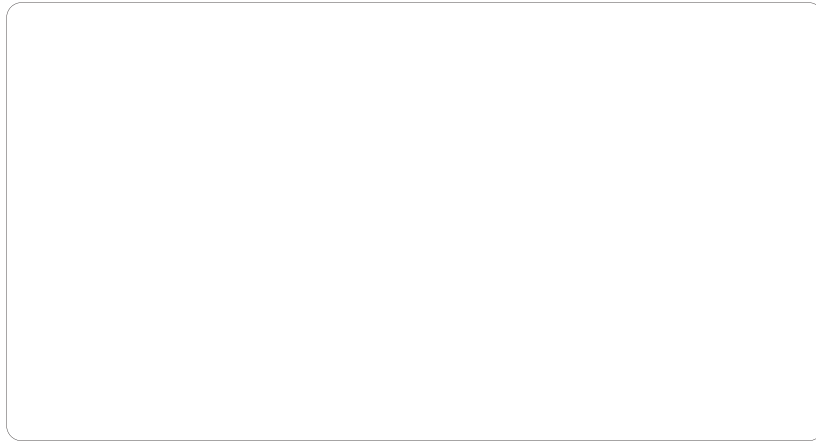

YOUR TRUSTED SUPPLIER / TWÓJ ZAUFANY DOSTAWCA



GET ACQUAINTED WITH OUR WIDE OFFER /
ZOBACZ NASZĄ BOGATĄ OFERTĘ



5 906083 000300 >

Copyright © TOYA S.A.