

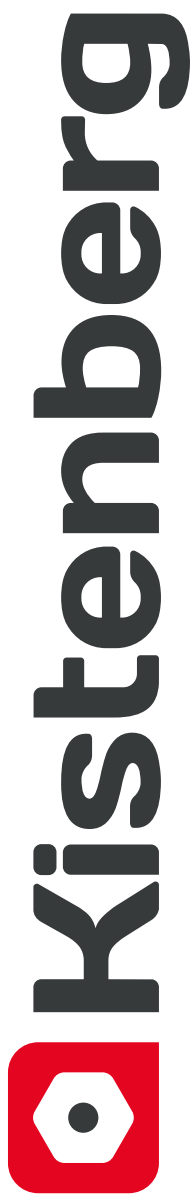













Kistenberg

You craft, we store.



Designations

Designations in the tables [pictographs]

-  symbol
-  length - mm
-  width - mm
-  height - mm
-  maximum load
-  maximum weight
-  polybag quantity
-  carton quantity
-  number of pieces on a Europalette
-  pallet height - mm
-  information



Each KISTENBERG product is treated with a personalized approach. Every element is meticulously designed, paying close attention to the finest details. In addition to their aesthetic appeal, we prioritize their functional purpose. Each product is assigned a distinct color profile to ensure optimal color coordination. All components are meticulously assembled by hand, strictly adhering to the specifications outlined in the technical documentation. This meticulous process guarantees the delivery of products of the utmost quality, ensuring your enjoyment for many years to come.

You craft, we store.

Index



X Block PRO
p. 8-9



X Block basket
p. 17



C Block BRIDGE
p. 36-37



Modular Solution
p. 52-53



Optima
p. 68-73



Smart
p. 83



X Block LOG
p. 10-11



X Block BRIDGE
p. 20-21



CMX organiser
p. 38-41



Modular Solution
p. 54-55



Evo
p. 74-79



Cargo
p. 84-85



X Block ALU LOG
p. 12-13



MSX organiser
p. 22-25



Foam insert
p. 42-43



Platform
p. 56-57



new
Dark
p. 80



Titan
p. 86-87



X Block TECH
p. 14-15



C Block PRO
p. 32-33



S Block PRO
p. 48



Heavy
p. 58-65



Aptop Plus
p. 81



Tager Carbo Plus Tager
p. 88-99



X Block Wagon
p. 16



C Block ALU LOG
p. 34-35



S Block ALU LOG
p. 49



Titan Plus
p. 66-67



Caliber
p. 82



Tager Case
p. 100



**Multicase
Cargo**
case
p. 101



**SQR
Box**
new
p. 109



**Truck
Max Plus**
p. 115



**Tager Box
Set**
new
p. 124-125



Multiholder
p. 129



**Tech
Stand**
new
p. 137



**Nor
Nor Duo**
p. 102-103



**Nort
& Knox**
p. 110



**Click
Box**
p. 117



**Titan Box
Set**
p. 126



**Orderline
Set**
p. 130-131



**Titan
Ladder**
p. 139



**Nors
Nors Duo**
p. 104-105



Nun
p. 111



**Truck
Truck Plus**
p. 118-119



**X Block Box
Set**
p. 126



**Bineer
Board**
p. 132



**Uni
Ladder**
new
p. 141



**Norb
Norb Duo**
p. 106-107



**Battery
Box**
p. 112-113



**Bineer Short
Bineer Set**
p. 120-121



**Unite Box
Set**
p. 127



**Bineer
Accessories**
p. 133



Cart T
p. 143



**MSX
Box**
p. 108



**Truck
Max**
p. 114



**Bineer Long
Bineer Set**
p. 122-123



Settruck
p. 128



**Titan
Stand**
p. 135



**Building
Assortment**
p. 144-145

Kisterberg





X Block modular system



X BLOCK is a modular series of toolboxes and tool trolleys for storing and transporting heavy tools.

The mobile module has elastomer-coated treaded wheels to improve balance and driving comfort.

The tool trolleys are offered in the built-up version or with a drawer to enable quick access to the heaviest tools without having to remove the interlocked modules. The heavily reinforced bodies and lids make the toolboxes highly resistant to pressure and mechanical damage.

Products from X Block series withstand a pressure capacity of up to **120 kg** and they can serve as working platforms for installation works. The maximum load capacity of each toolbox is up to 50 kg.

Each tool case and toolbox in this series has a space **for locking it with a padlock.**

Toolboxes are equipped with organisers and trays making it easy to arrange the internal storage space for tools, and the lids are provided with a solid gasket for **dust and water resistance.**

X Block series is equipped with a double connector to allow modular connection with the X BLOCK, X BLOCK BRIDGE, C BLOCK, C BLOCK BRIDGE, S BLOCK PRO 45, S BLOCK PRO 55, S BLOCK ALU LOG 45, S BLOCK ALU LOG 55 series.

It is available in PRO, LOG, ALU LOG and TECH versions.

You craft, we store.

X Block PRO



X Block LOG



X Block ALU LOG

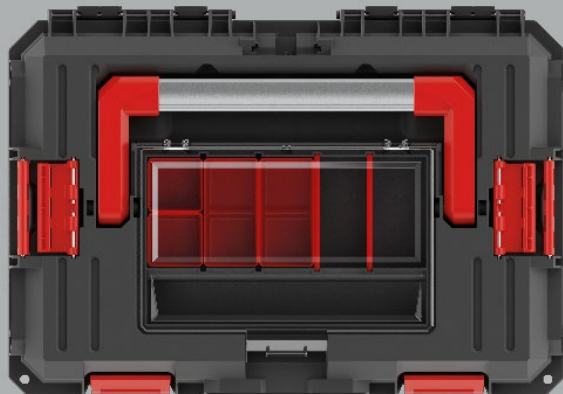

X Block TECH



Kistenberg



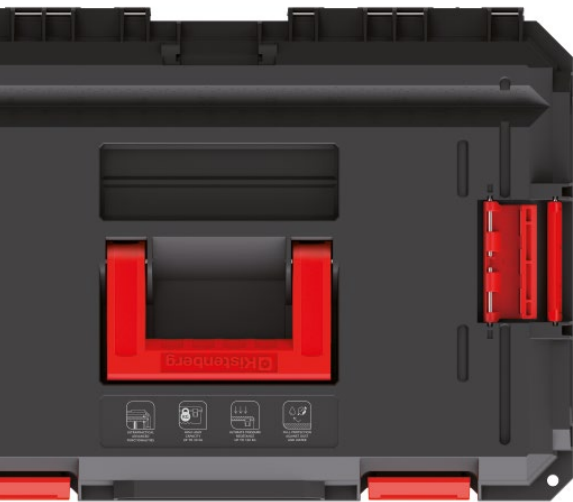





X Block PRO modular system



plain lid



IP55

	X BLOCK PRO set	X BLOCK PRO set
	KXBS604095	KXBS6040100
	S411	S411
 mm	546 x 380 x 870	546 x 380 x 970
 kg	~	~
 pcs	-	-
 pcs	8	6
 mm	~ 1890	~ 1660
	tool trolley, toolbox, organiser	tool trolley, basket, organiser



X BLOCK PRO:

- Very durable body with reinforced structure
- Interlocking system for joining with X Block, S Block and C Block series
- Boxes and internal separators for organising the interior space
- Solid gasket ensures that the product is dustproof and water resistant
- Pressure resistance up to 120 kg
- Full protection against dust and water **IP55**





	X BLOCK PRO 20 tool case	X BLOCK PRO 30 toolbox	X BLOCK PRO 40 toolbox	X BLOCK PRO 40 tool trolley	X BLOCK PRO 40 tool trolley	X BLOCK PRO 50 tool trolley
	KXB604020	KXB604030	KXB604040	KXB604045	KXB604050	KXB604050D
	S411	S411	S411	S411	S411	S411
mm	546 x 380 x 194	546 x 380 x 307	546 x 380 x 407	546 x 380 x 400	546 x 380 x 510	546 x 380 x 510
kg	~ 50	~ 50	~ 50	~ 50	~ 50	~ 50
pcs	-	-	-	-	-	-
pcs	36	24	16	16	12	12
mm	~ 1760	~ 1910	~ 1720	~ 1750	~ 1830	~ 1830
	interlocking system, boxes, plain lid, metal hinges, 2 x handles for easy carrying	interlocking system, 2 x trays, 2 x separators, plain lid, metal hinges	interlocking system, 2 x trays, 2 x separators, plain lid, metal hinges	interlocking system, 2 x tray, 2 x tool holder, 2 x separators, plain lid, metal hinges	interlocking system, 2 x tray, 2 x tool holder, 2 x separators, plain lid, metal hinges	interlocking system, drawer without IP55, 2 x tray, 2 x tool holder, plain lid, metal hinges



 Kistenberg

X Block LOG modular system











organiser in the lid

X BLOCK LOG:

- Very durable body with reinforced structure
- Boxes and internal separators for arranging the interior space
- Solid gasket ensures that the product is dust proof and water resistant
- Transparent organisers with a polycarbonate covers
- Separators in the organiser
- Tool organiser in the cover
- Pressure resistance up to 120 kg
- Full protection against dust and water **IP55**



IP55

	X BLOCK LOG set
	KXBS604085F
 colour	S411
 mm	546 x 380 x 785
 kg	~
 pcs	-
 pcs	8
 mm	~ 1720
	tool trolley, toolbox





	X BLOCK LOG 20 tool case	X BLOCK LOG 30 toolbox	X BLOCK LOG 40 toolbox	X BLOCK LOG 40 tool trolley	X BLOCK LOG 50 tool trolley	X BLOCK LOG 50 tool trolley
	KXB604020F	KXB604030F	KXB604040F	KXB604045F	KXB604050F	KXB604050FD
	S411	S411	S411	S411	S411	S411
mm	546 x 380 x 194	546 x 380 x 307	546 x 380 x 407	546 x 380 x 400	546 x 380 x 510	546 x 380 x 510
kg	~ 50	~ 50	~ 50	~ 50	~ 50	~ 50
pcs	-	-	-	-	-	-
pcs	36	24	16	16	12	12
mm	~ 1760	~ 1910	~ 1720	~ 1750	~ 1830	~ 1830
	interlocking system, boxes, organiser in the lid, metal hinges, 2 x handles for easy carrying, 8 x separators	interlocking system, 2 x trays, 8 x separators, organiser in the lid, metal hinges	interlocking system, 2 x trays, 8 x separators, organiser in the lid, metal hinges	interlocking system, 2 x tray, 2 x tool holder, 8 x separators, organiser in the lid, metal hinges	interlocking system, 2 x tray, 2 x tool holder, 8 x separators, organiser in the lid, metal hinges	interlocking system, drawer without IP55, 2 x tray, 2 x tool holder, 6 x separators, metal hinges, organiser in the lid







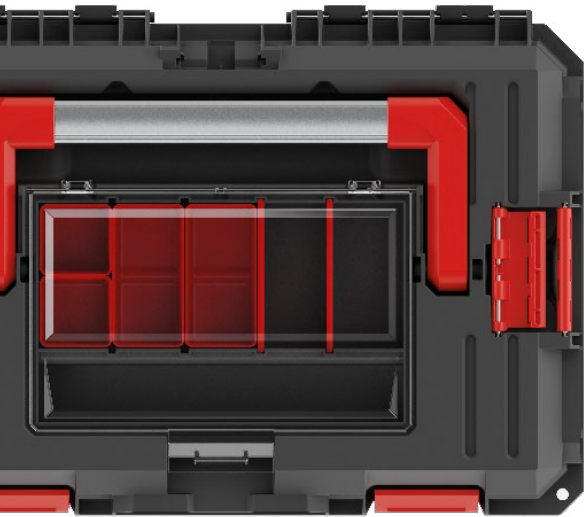



 Kistenberg

X Block ALU LOG modular system



IP55

X BLOCK ALU LOG set

	KXBAS604075
 colour	S411
 mm	546 x 380 x 685
 kg	~
 pcs	-
 pcs	8
 mm	~ 1530
	tool trolley, toolbox



organiser in the lid

X BLOCK ALU LOG:

- Organizer with separators and boxes in the lid
- Interlocking system for joining with X Block, S Block and C Block series
- Very durable body with reinforced structure
- Solid gasket ensures that the product is dust proof and water resistant
- Functional internal partitions for arranging the interior space
- Durable ABS latches
- Aluminium handle
- Pressure resistance up to 120 kg
- Full protection against dust and water **IP55**









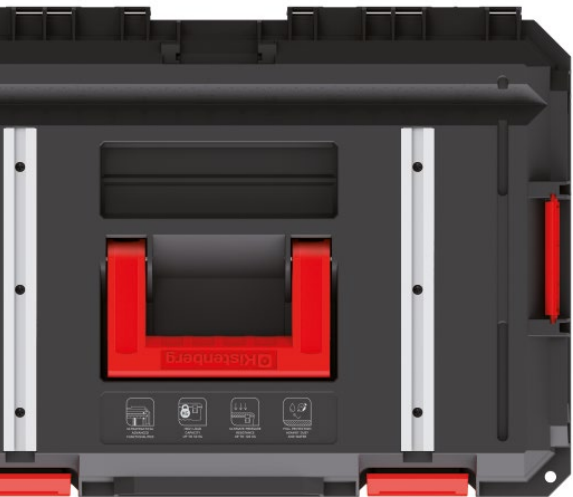

	X BLOCK ALU LOG 30 toolbox	X BLOCK ALU LOG 40 toolbox	X BLOCK ALU LOG 40 tool trolley	X BLOCK ALU LOG 50 tool trolley	X BLOCK ALU LOG 50 tool trolley
	KXBA604030	KXBA604040	KXBA604045	KXBA604050	KXBA604050D
	S411	S411	S411	S411	S411
MM	546 x 380 x 307	546 x 380 x 407	546 x 380 x 400	546 x 380 x 510	546 x 380 x 510
KG	~ 50	~ 50	~ 50	~ 50	~ 50
PCS	-	-	-	-	-
PCS	24	16	16	12	12
MM	~ 1910	~ 1720	~ 1750	~ 1830	~ 1830
	double interlocking system, 2 x trays, 6 x separators, 4 x boxes, organiser in the lid, metal hinges	double interlocking system, 2 x trays, 6 x separators, 4 x boxes, organiser in the lid, metal hinges	interlocking system, 2 x tray, 2 x tool holder, 6 x separators, organiser in the lid, metal hinges, 4 x boxes	interlocking system, 2 x tray, 2 x tool holder, 6 x separators, organiser in the lid, metal hinges, 4 x boxes	interlocking system, drawer without IP55, 2 x tray, 2 x tool holder, 4 x separators, metal hinges, organiser in the lid, 4 x boxes



X Block TECH modular system



	X BLOCK TECH 20 tool case	X BLOCK TECH 30 toolbox	X BLOCK TECH 40 toolbox
	KXB604020G	KXB604030G	KXB604040G
 colour	S411	S411	S411
 mm	546 x 380 x 194	546 x 380 x 307	546 x 380 x 407
 kg	~ 50	~ 50	~ 50
 pcs	-	-	-
 pcs	36	24	16
 mm	~ 1760	~ 1910	~ 1720
	interlocking system, 6 x boxes, metal hinges, rails for G-clamps set in the lid, 2 x handles for easy carrying, 2 x separators	interlocking system, 2 x trays, 2 x separators, metal hinges, rails for G-clamps set in the lid,	interlocking system, 2 x trays, 2 x separators, metal hinges, rails for G-clamps set in the lid,

rails for G-clamps

X BLOCK TECH:

- Very durable body with reinforced structure
- Large load capacity, easy transport of even the heaviest tools
- Solid gasket ensures that the product is dust proof and water resistant
- Aluminum rails allowing the attachment of G-clamps, turning the box into a compact „workshop table“
- Pressure resistance up to 120 kg
- Full protection against dust and water **IP55**





	X BLOCK TECH 40 tool trolley	X BLOCK TECH 50 tool trolley	X BLOCK TECH 50 tool trolley
	KXB604045G	KXB604050G	KXB604050GD
	S411	S411	S411
mm	546 x 380 x 400	546 x 380 x 510	546 x 380 x 510
kg	~ 50	~ 50	~ 50
pcs	-	-	-
pcs	16	12	12
mm	~ 1750	~ 1830	~ 1830
	interlocking system, 2 x tray, 2 x tool holder, 2 x separators, rails for G-clamps set in the lid, metal hinges	interlocking system, 2 x tray, 2 x tool holder, 2 x separators, rails for G-clamps set in the lid, metal hinges	interlocking system, drawer without IP55, 2 x tray, 2 x tool holder, rails for G-clamps set in the lid, metal hinges







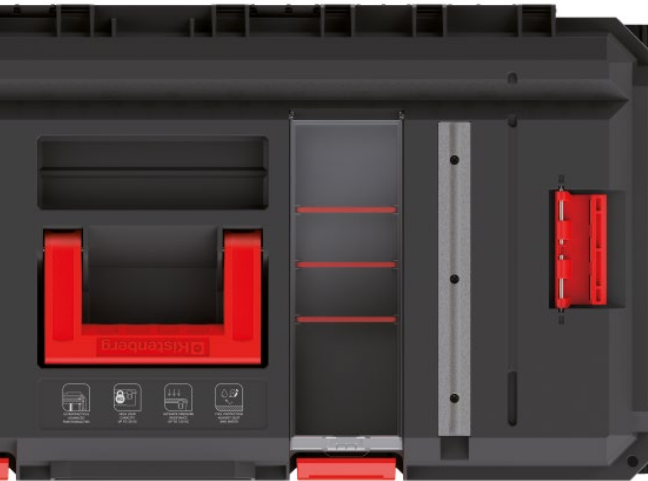



X Block Wagon

PRO/TECH modular system



Platform



	X BLOCK PRO wagon	X BLOCK TECH wagon	PLATFORM transport platform
	KXB8040W	KXB8040WF	KXBP6045
 colour	S411	S411	S411
 mm	795 x 380 x 307	795 x 380 x 307	585 x 440 x 145
 kg	~ 50	~ 50	~ 150
 pcs	-	-	- / 3
 pcs	18	18	42
 mm	~ 1920	~ 1920	~ 1900
	interlocking system, plain lid, metal hinges, 2 x separators, ABS latches	interlocking system, 5 x separators, g - clamps rails in the lid, metal hinges, ABS latches, organiser set in the lid	Platform is compatible with X Block Equipped with 4 fully rotating metal wheels for easy of movement (two of which have been fitted with brakes). The solid ribbing design ensures a load capacity of up to 150 kg.

X BLOCK WAGON:

- Very durable body with reinforced structure
- Two handles for easy transport
- Solid gasket ensures that the product is dustproof and water resistant
- Solid wheels with tread ensuring comfort of use
- Connectors for joining with X Block system elements
- Full protection against dust and water **IP55**



X Block PRO modular system



	X BLOCK PRO basket	X BLOCK PRO basket	X BLOCK PRO basket	X BLOCK cargo
	KXB604030CS	KXB604020C	KXB604030C	KXBC
colour	S411	S411	S411	S411
mm	536 x 354 x 300	544 x 362 x 200	544 x 362 x 300	343 x 197 x 100
kg	~ 50	~ 25	~ 25	~ 8
pcs	3 / -	5 / -	5 / -	5 / 30
pcs	36	80	60	540
mm	~ 1950	~ 1680	~ 1700	~ 1700
	interlocking system - top, center, bottom, 2 x separators	interlocking system - top only, easy stackable - turn 180°	interlocking system - top only, easy stackable - turn 180°	



X BLOCK BASKET:

- Very durable body with reinforced structure
- Possibility of connecting and stacking with X Block system elements
- Internal separators for customising the interior space





full protection against dust and water

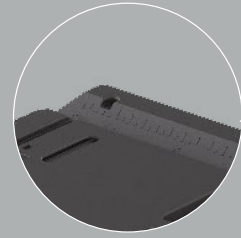

removable separators

deep cargo box

drawer organiser

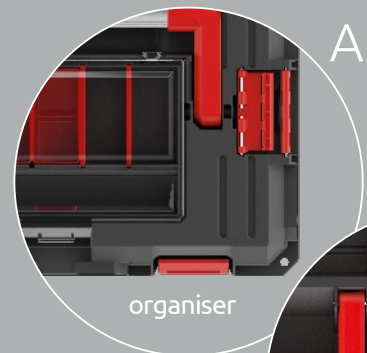

Alu Log

organiser

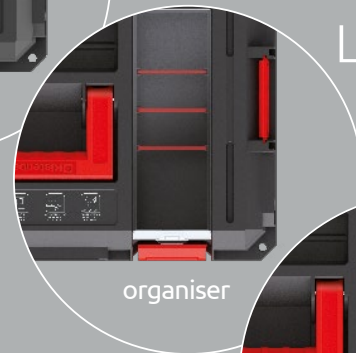

Log

organiser

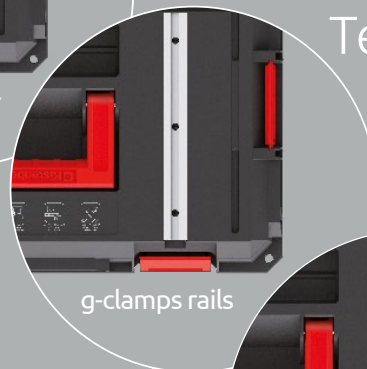

Tech

g-clamps rails

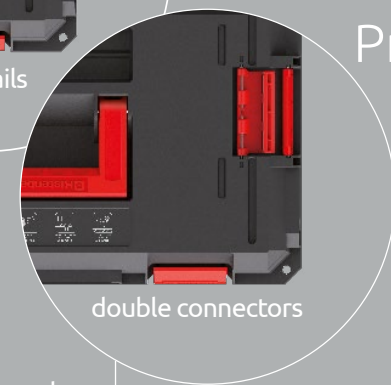

Pro

double connectors



ergonomic telescopic handle

interlocking system

very durable body with reinforced structure

elastomer-coated wheels allow safe transport

You craft, we store.

Combine any of Pro/ Log/ Alu Log/ Tech/ series and create your own unique set



X Block BRIDGE modular system

X Block Bridge is a smart way to connect X Block Series with MSX organisers



X BLOCK BRIDGE MODULAR SYSTEM:

- Interlocking base to MSX system
- MSX locking system in lid
- Durable fasteners made of ABS with metal
- Additional MSX BOX organiser for storing small items
- Body made of a mixture of increased strength polymers
- Ergonomic handle
- Transparent polycarbonate lid
- Functional boxes and separators
- Lots of storage space
- Full protection against dust and water **IP55**



	X BLOCK BRIDGE organiser	X BLOCK BRIDGE organiser
	KXBB5540B	KXBB5540S
	S411	S411
	mm 543 x 368 x 122	mm 543 x 368 x 122
	kg ~ 20	kg ~ 20
	pcs 3 /-	pcs 3 /-
	pcs 48	pcs 48
	mm ~ 1620	mm ~ 1620
	interlocking base between X Block and MSX / CMX series, MSX locking system in polycarbonate lid, solid gasket, latches made of ABS with metal, 7 x boxes, 1 x MSX Box	interlocking base between X Block and MSX / CMX series, MSX locking system in polycarbonate lid, solid gasket, latches made of ABS with metal, 11 x separators, 2 x boxes



X BLOCK BRIDGE organiser

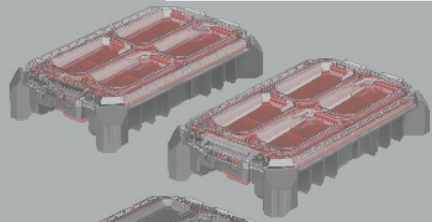

MSX organiser
go to next page

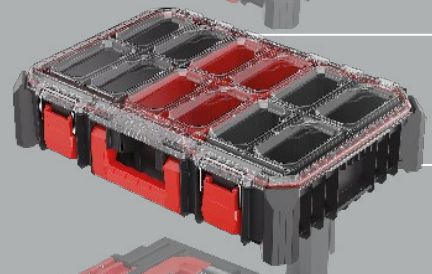
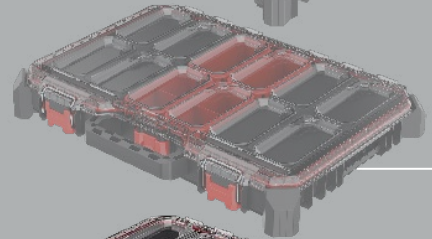

X Block BRIDGE



X Block tool trolley

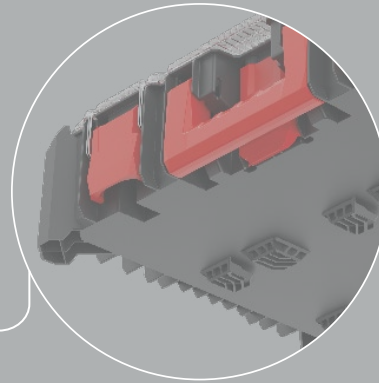

locking system
slide and click

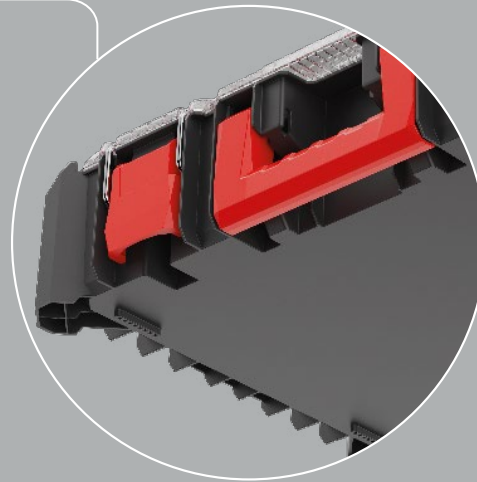

MSX range
go to next page



MSX organiser modular system



	MSX 25 organiser low	MSX 25 organiser high	MSX 55 organiser low	MSX 55 organiser high
	KMX40258B	KMX402515B	KMX55408B	KMX554015B
	S411	S411	S411	S411
	228 x 368 x 77	228 x 368 x 126	543 x 390 x 77	543 x 368 x 126
	-	-	~ 20	~ 20
	5 / -	5 / -	5 / -	3 / -
	250	125	100	60
	~ 1860	~ 1780	~ 1840	~ 1920
	MSX locking system, solid gasket, polycarbonate lid, 4 x boxes, metal hinges	MSX locking system, solid gasket, polycarbonate lid, 5 x boxes, 3 x separators, metal hinges	MSX locking system, polycarbonate lid, 7 x boxes, 1 x MSX Box organiser, 3 x separators, solid gasket, metal hinges, ABS latches with metal	MSX locking system, polycarbonate lid, 7 x boxes, 1 x MSX Box organiser, 4 x separators, solid gasket, metal hinges, ABS latches with metal

MSX MODULAR SYSTEM ORGANISERS:

- Interlocking system for joining with MSX, X Block Bridge, Modular Solution series
- Durable latches made of ABS with metal
- Body made of a mixture of increased strength polymers
- Ergonomic handle
- Transparent polycarbonate lid
- Functional boxes and separators
- Additional organiser for storing small items
- Lots of storage space
- Full protection against dust and water **IP55**



You craft, we store.

MSX organiser modular system



	MSX 25 organiser low	MSX 25 organiser high	MSX 55 organiser low	MSX 55 organiser high
	KMX40258S	KMX402515S	KMX55408S	KMX554015S
	S411	S411	S411	S411
	228 x 368 x 77	228 x 368 x 126	543 x 390 x 77	543 x 368 x 126
	-	-	~ 20	~ 20
	5 / -	5 / -	5 / -	3 / -
	250	125	100	60
	~ 1860	~ 1780	~ 1840	~ 1920
	MSX locking system, metal hinges, solid gasket, polycarbonate lid, 3 x separators,	MSX locking system, metal hinges, solid gasket, polycarbonate lid, 3 x separators,	MSX locking system, metal hinges, polycarbonate lid, 2 x boxes, 7 x separators, solid gasket, ABS latches with metal	MSX locking system, metal hinges, polycarbonate lid, 2 x boxes, 11 x separators, solid gasket, ABS latches with metal



MSX set

organiser
modular system



KMX55408B









KMX554015B

IP55



MSX organiser set

	KMXS5540B
colour	S411
 mm	543 x 390 x 200
 kg	~ 20 / 20
 pcs	- / -
 pcs	36
 mm	~ 1880
	MSX locking system, set of 2 organisers, polycarbonate lid, 14 x boxes, 2 x MSX Box, 7 x separators



MSX locking system

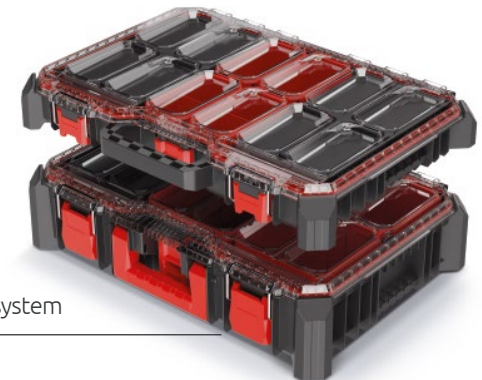

You craft, we store.

MSX set organiser set modular system



KMX55408S



KMX554015S



	MSX organiser set
	KMX5540S
colour	S411
	mm 543 x 390 x 200
	kg ~ 20 / 20
	pcs - / -
	pcs 36
	mm ~ 1880
	MSX locking system, set of 2 organisers, polycarbonate lid, ABS latches with metal, 18 x separators, 4 x boxes



MSX locking system

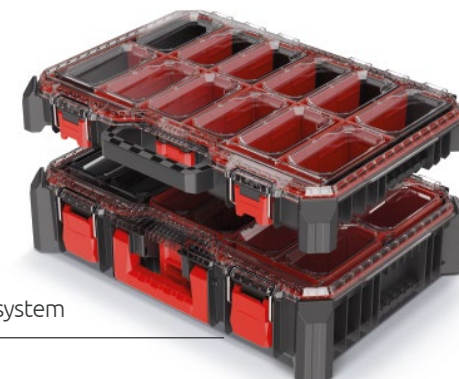

easy
to connect



MSX organiser
any model

X Block BRIDGE
any model

X Block PRO
X Block LOG
X Block TECH
toolbox
tool trolley
any model



MSX organiser
any model

X Block BRIDGE
any model

X Block PRO
X Block LOG
X Block TECH
toolbox
tool trolley
any model

MSX
organiser

X Block BRIDGE go to page
organiser

X Block
toolbox / tool trolley

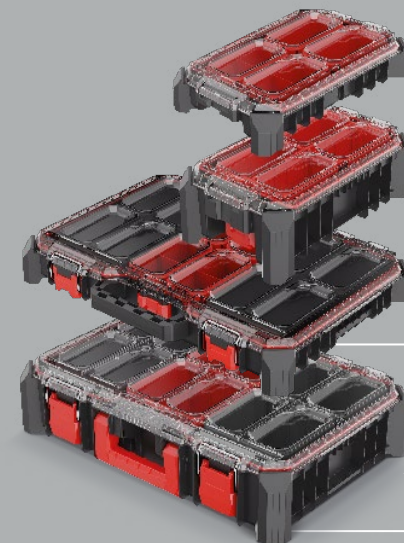

MSX organiser
any model

X Block BRIDGE
any model

CREATE YOUR OWN SET



MSX
organiser
→ **Modular Solution**
toolbox / tool trolley

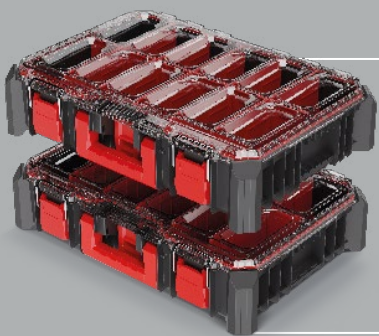

MSX organiser
any model



MSX organiser
any model

Modular Solution
toolbox
tool trolley
any model



MSX organiser
any model

Modular Solution
toolbox
tool trolley
any model

 Kistenberg

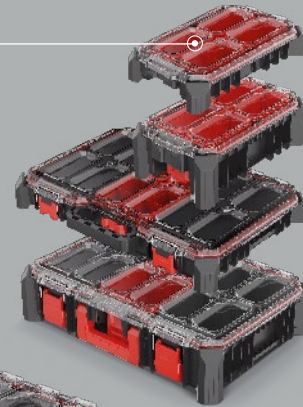
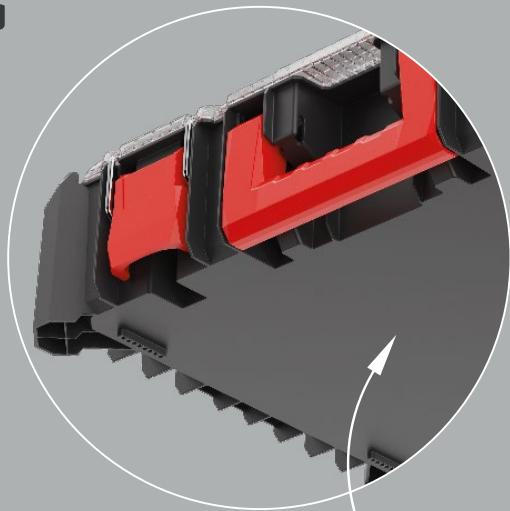

MSX organiser
any model

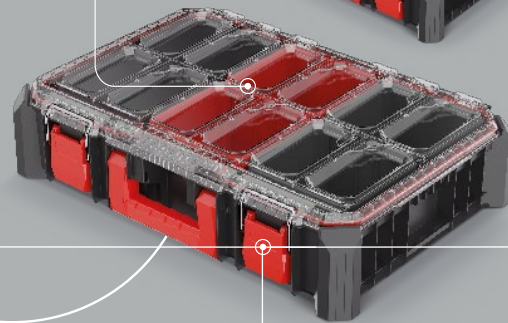

X BLOCK BRIDGE
organiser

X Block Bridge is a smart way to connect X Block Series with MSX organisers



X Block
PRO/LOG/TECH
tool trolley
any model

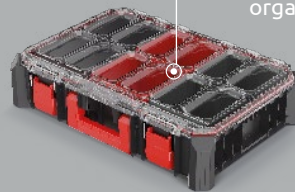

X Block BRIDGE
organiser



Modular
Solution
toolbox, tool trolley
any model

easy
to connect

You craft, we store.

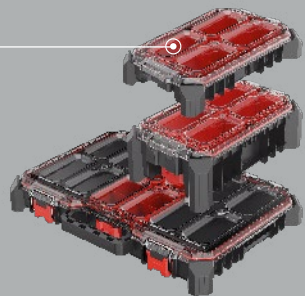
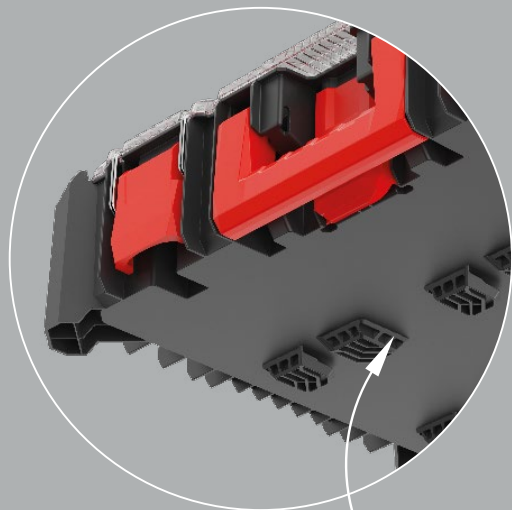

MSX organiser
any model

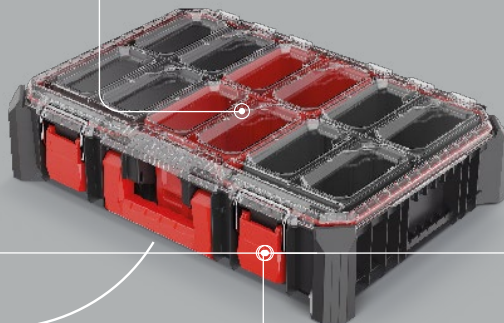

MSX ORGANISER



X Block
tool trolley

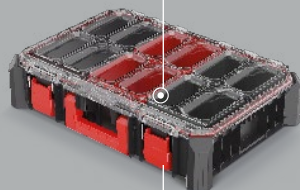

X Block BRIDGE
organiser
any model



Modular
Solution
toolbox, tool trolley
any model



X Block
PRO/LOG/TECH
tool trolley
any model

C Block modular system



C BLOCK is a professional modular system - modules withstand a pressure capacity of up to **100 kg** and they can serve as working platforms for installation works. The maximum load capacity of each toolbox is up to 25 kg. The lids are provided with a solid gasket for **dust and water resistance**.

Each tool case and toolbox in this series has a space **for locking it with a padlock**. Modules are equipped with **practical organisers** and trays.

The C BLOCK line is compatible with the X BLOCK PRO, X BLOCK ALU LOG, S BLOCK PRO 45 and S BLOCK ALU LOG 45 series modular toolboxes.

It is available in PRO and ALU LOG versions.

C Block PRO

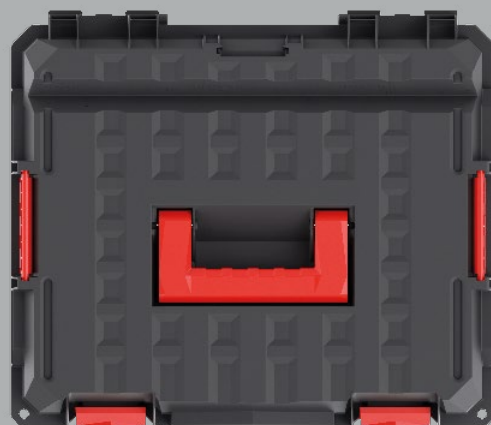

C Block ALU LOG

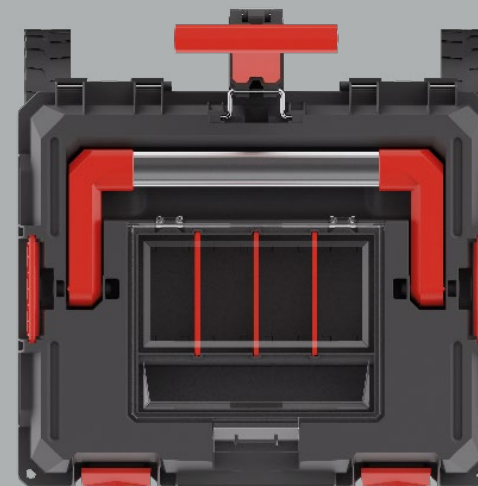

You craft, we store.

CMX
ORGANISER

C Block
BRIDGE

C Block 30
TOOLBOX

PLATFORM
TRANSPORT PLATFORM



THE MOST COMPACT MODULAR TOOLBOX SERIES IN OUR OFFER

C Block PRO

compact modular system

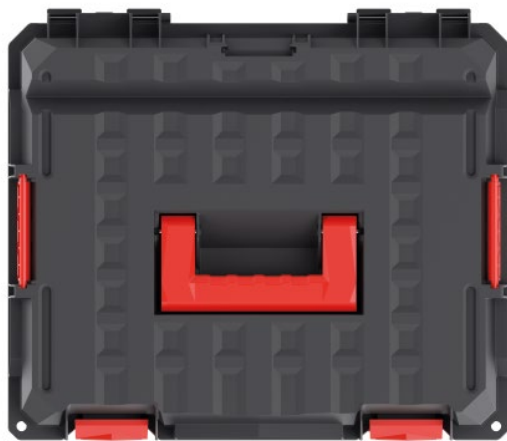

	C BLOCK 15 tool case	C BLOCK 15 tool case	C BLOCK 30 toolbox
	KXC454015	KXC454015P	KXC454030
	S411	S411	S411
	450 x 380 x 135	450 x 380 x 135	450 x 380 x 290
	~ 25	~ 25	~ 25
	-	-	-
	68	68	32
	~ 1910	~ 1910	~ 1890
	2 x removable separators, ABS latches, metal hinges	2 x removable separators, foam inside, ABS latches, metal hinges	1 x deep tray, 3 x removable separators, ABS latches, metal hinges

C BLOCK PRO:

- Body made of a mixture of increased strength polymers
- Internal separators for arranging the interior space
- Solid gasket ensures that the product is dust proof and water resistant
- Maximum load capacity of each box is up to 25 kg
- Interlocking system for joining with C Block, with X Block PRO / ALU LOG, S Block 45, C Block Bridge
- Full protection against dust and water **IP55**



C Block PRO

compact modular system



	C BLOCK 40 tool trolley	C BLOCK PRO set
	KXC454040	KXCS454080
colour	S411	S411
mm	450 x 380 x 380	450 x 380 x 800
kg	~ 25	~
pcs	-	-
pcs	16	8
mm	~ 1670	~ 1750
	deep tray, 2 x removable separators, 2 x removable tool holder, ABS latches, metal hinges,	tool trolley, toolbox, tool case



C Block ALU LOG compact modular system

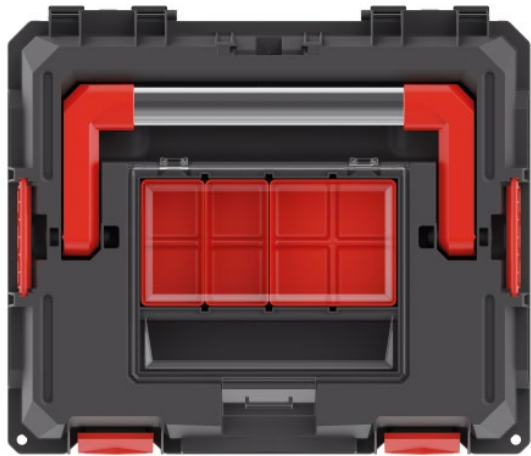

organiser set in the lid

C BLOCK ALU LOG:

- Body made of a mixture of increased strength polymers
- Internal separators for arranging the interior space
- Solid gasket ensures that the product is dust proof and water resistant
- Maximum load capacity of each box is up to 25 kg
- Interlocking system for joining with C Block, X Block PRO / ALU LOG, S Block 45, C Block Bridge
- Durable ABS latches
- Pressure resistance up to 100 kg
- Transparent cover made of polycarbonate
- Full protection against dust and water **IP55**



C BLOCK ALU LOG 15 tool case



C BLOCK ALU LOG 30 toolbox

	KXCA454015	KXCA454030
colour	S411	S411
mm	450 x 380 x 168	450 x 380 x 297
kg	~ 25	~ 25
pcs	-	-
pcs	60	32
mm	~ 1920	~ 1920
	2 x removable separators, metal hinges, 3 x removable separators and 4 x boxes in the lid	1 x deep tray, 3 x removable separators, ABS latches, 3 x removable separators and 4 x boxes in the lid, metal hinges



C Block ALU LOG compact modular system



organiser set in the lid



	C BLOCK ALU LOG 40 tool trolley	C BLOCK PRO/ALU LOG set	C BLOCK ALU LOG set
	KXCA454040	KXCS454055	KXCAS454085
colour	S411	S411	S411
mm	450 x 380 x 388	450 x 380 x 545	450 x 380 x 845
kg	~ 25	~	~
pcs	-	-	-
pcs	16	12	8
mm	~ 1700	~ 1800	~ 1840
	1 x deep tray, 2 x removable separators, ABS latches, 2 x tool holder, 3 x removable separators and 4 x boxes in the lid, metal hinges	tool trolley PRO, tool case ALU LOG	tool trolley, toolbox, tool case



C Block BRIDGE compact modular system



	C BLOCK BRIDGE organiser	C BLOCK BRIDGE organiser
	KCBB4540B	KCBB4540S
colour	S411	S411
mm	445 x 368 x 122	445 x 368 x 122
kg	~ 20	~ 20
pcs	3 / -	3 / -
pcs	72	72
mm	~ 1880	~ 1880
	11 x removable boxes, solid gasket, metal hinges, removable separator	7 x removable separators, 2 x boxes, solid gasket, metal hinges,

C BLOCK BRIDGE:

- Interlocking base between C Block and CMX system
- Compatible with X Block PRO / ALU LOG series
- Solid gasket ensures that the product is dust proof and water resistant
- Durable latches made of ABS with metal
- Body made of a mixture of increased strength polymers
- Ergonomic handle
- Transparent polycarbonate lid
- Functional boxes for arranging the interior space
- Lots of storage space for small items
- Full protection against dust and water **IP55**



C BLOCK BRIDGE organiser

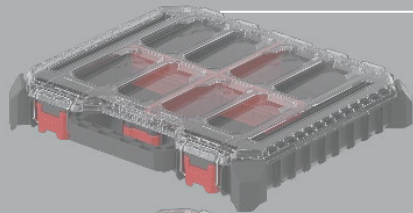

CMX organiser

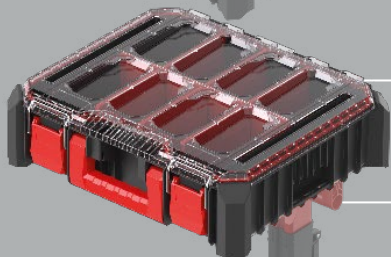
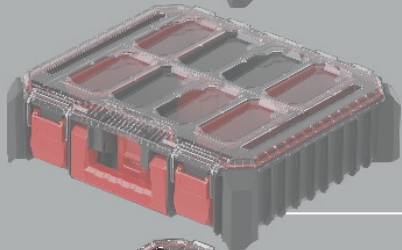

C Block BRIDGE



C Block tool trolley

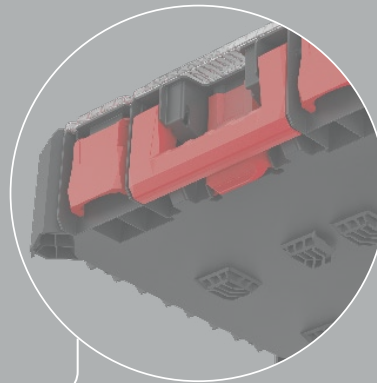

locking system
slide and click

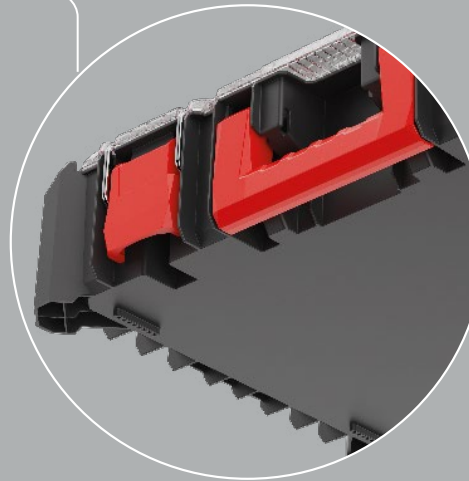

CMX range
go to next page



CMX organiser compact modular system

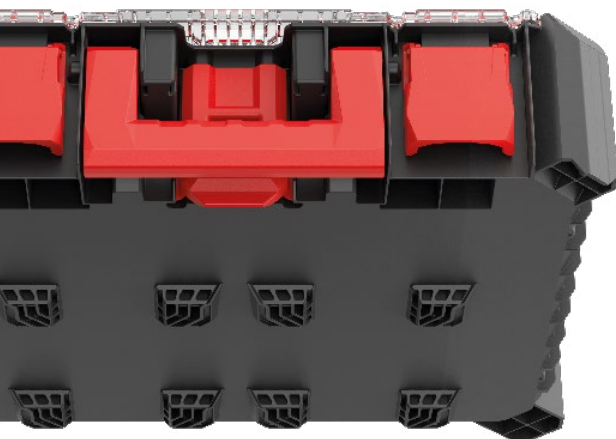

	CMX 45 organiser low	CMX 45 organiser high	CMX 45 organiser high
	KCX45408B	KCX454015B	KCX454015B2
colour	S411	S411	S411
mm	445 x 390 x 77	445 x 368 x 126	445 x 368 x 126
kg	~ 20	~ 20	~ 20
pcs	4 / -	3 / -	3 / -
pcs	128	72	72
mm	~ 1910	~ 1910	~ 1910
	10 x removable boxes, solid gasket, metal hinges, handle for easy carrying	13 x removable boxes, removable separator, solid gasket, metal hinges	6 x removable boxes, 4 x removable separators, 1x MSX Box organiser, solid gasket, metal hinges,

CMX MODULAR SYSTEM ORGANISERS:

- MSX locking system compatible with CMX Organisers C Block Bridge, X Block Bridge, MSX Organisers
- A solid gasket ensures that the product is dust proof and water resistant
- Durable latches made of ABS with metal
- Body made of a mixture of increased strength polymers
- Ergonomic handle
- Transparent polycarbonate lid
- Functional boxes for arranging the interior space
- Lots of storage space for small items
- Full protection against dust and water **IP55**



You craft, we store.

CMX

organiser

compact modular system



	CMX 45 organiser low	CMX 45 organiser high
	KCX45408S	KCX454015S
colour	S411	S411
mm	445 x 390 x 77	445 x 368 x 126
kg	~ 20	~ 20
pcs	4 / -	3 / -
pcs	128	72
mm	~ 1910	~ 1910
	3 x removable separators, 2 x removable boxes, solid gasket, metal hinges,	4 x removable boxes, 7 x removable separators, solid gasket, metal hinges,



 Kistenberg

CMX set

organiser
compact modular system



KCX45408B









KCX454015B2

**MSX locking system compatible with CMX organiser series,
MSX organiser series, C Block Bridge, X Block Bridge**



IP55

	CMX organiser set
	KCX45408B
colour	S411
 mm	445 x 390 x 197
 kg	~ 20 / 20
 pcs	- / -
 pcs	48
 mm	~ 1910
	CMX organiser set of 2 organisers KCX45408B + KCX454015B2



locking system



You craft, we store.

CMX set

organiser

compact modular system



KCX45408B



KCX454015S

IP55



	CMX organiser set
	KCX4540BS
colour	S411
	mm 445 x 390 x 197
	kg ~ 20 / 20
	pcs - / -
	pcs 48
	mm ~ 1910
	CMX organiser set of 2 organisers KCX45408B + KCX454015S



locking system











Foam insert

Two layer foam



20 mm



	FOAM insert	FOAM insert	FOAM insert
	KFI402	KFI452	KFI552
 colour	GRAY	GRAY	GRAY
 mm	285 x 155 x 20	305 x 285 x 20	475 x 285 x 20
 kg	-	-	-
 pcs	9 / -	9 / -	9 / -
 pcs	1620	864	486
 mm	~ 1850	~ 1850	~ 1850
	two layer foam compatible with: MSX organiser KMX40258B/S, KMX402515B/S.	two layer foam compatible with: C Block BRIDGE organiser KCBB4540B/S, CMX organiser KCX45408B/S, KCX454015B/S.	two layer foam compatible with: X Block BRIDGE organiser KXBB5540B/S, MSX organiser KMX55408B/S, KMX554015B/S.

Foam insert



Three layer foam



30 mm

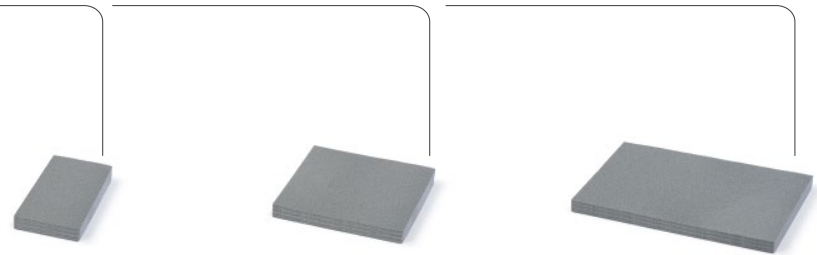

	FOAM insert	FOAM insert	FOAM insert
	KFI403	KFI453	KFI553
	GRAY	GRAY	GRAY
	mm	mm	mm
	kg	kg	kg
	pcs	pcs	pcs
	pcs	pcs	pcs
	mm	mm	mm
	three layer foam compatible with: MSX organiser KMX40258B/S, KMX402515B/S.	three layer foam compatible with: C Block BRIDGE organiser KCBB4540B/S, CMX organiser KCX45408B/S, KCX454015B/S.	three layer foam compatible with: X Block BRIDGE organiser KXBB5540B/S, MSX organiser KMX55408B/S, KMX554015B/S.

FOAM INSERT:

- Two or three-layer foam
- Single layer thickness is 10 mm
- Fits selected modular organisers
X Block Bridge, C Block Bridge, MSX, CMX
- Provides safe transport of tools



easy
to connect

CMX/MSX

organiser

C Block BRIDGE

organiser

C Block / X Block

toolbox / tool trolley

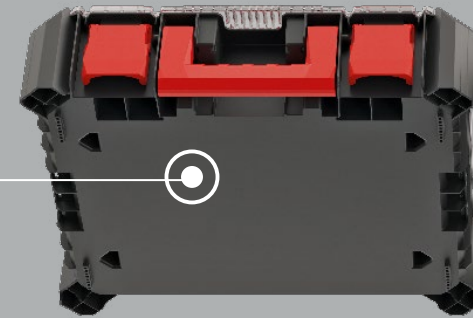

CMX organiser
any model



C Block BRIDGE
any model



C Block PRO
C Block ALU LOG
toolbox
tool trolley
any model



MSX organiser
only model
KMX40258, KMX402515

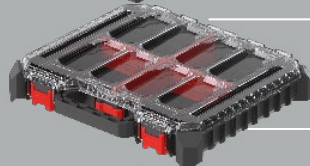

CMX organiser
any model



C Block BRIDGE
any model



C Block PRO
C Block ALU LOG
toolbox
tool trolley
any model

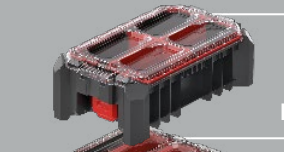

MSX organiser
only model
KMX40258, KMX402515

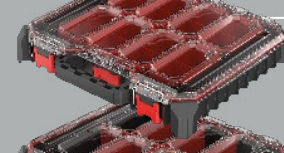

CMX organiser
any model

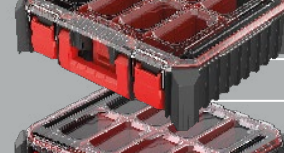

C Block BRIDGE
any model

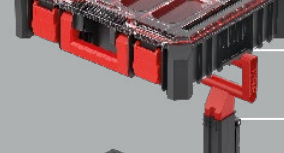

X Block PRO
X Block ALU LOG
toolbox
tool trolley

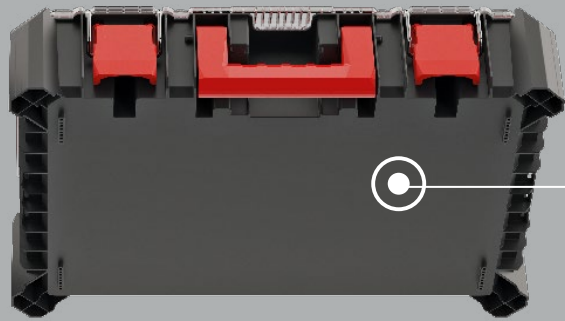

CMX / MSX
organiser

X Block BRIDGE
organiser

X Block
toolbox / tool trolley

CREATE YOUR OWN SET



MSX organiser
only model
KMX40258, KMX402515

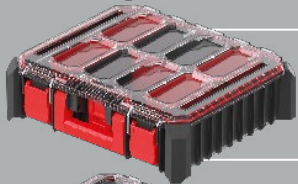

CMX organiser
any model

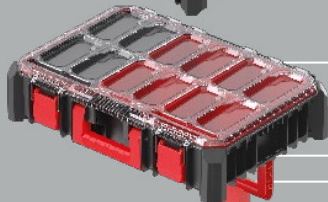

X Block BRIDGE
any model



X Block PRO
X Block LOG
X Block ALU LOG
X Block TECH
toolbox
tool trolley
any model

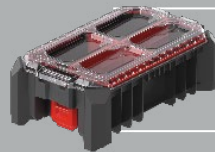

MSX organiser
only model
KMX40258, KMX402515

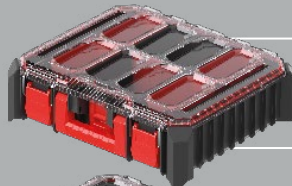

CMX organiser
any model

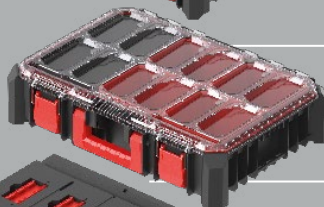

X Block BRIDGE
any model



X Block PRO
wagon

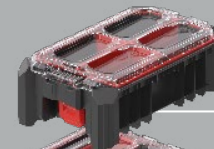

MSX organiser
only model
KMX40258, KMX402515

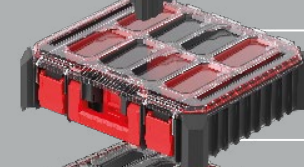

CMX organiser
any model

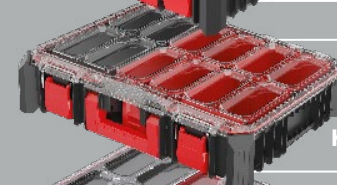

MSX organiser
only model
KMX55408, KMX554015

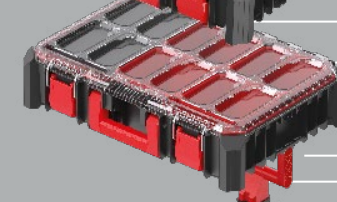

X Block BRIDGE
any model



X Block PRO
X Block LOG
X Block ALU LOG
X Block TECH
toolbox
tool trolley
any model

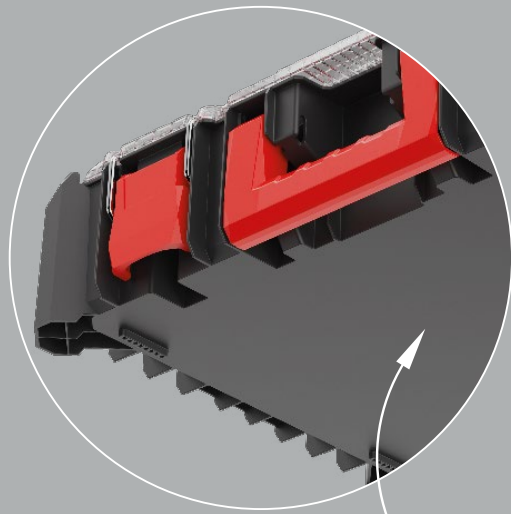

CMX organiser
any model



C BLOCK BRIDGE
organiser



X Block
PRO/ALU LOG
tool trolley
any model



C Block
PRO/ALU LOG
tool trolley
any model

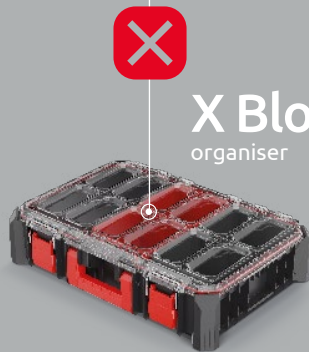

X Block BRIDGE
organiser



Modular Solution
toolbox, tool trolley
any model

C Block Bridge is a smart way to connect way to combine C Block Series, X Block PRO ALU LOG with MSX organisers & CMX organisers

easy
to connect

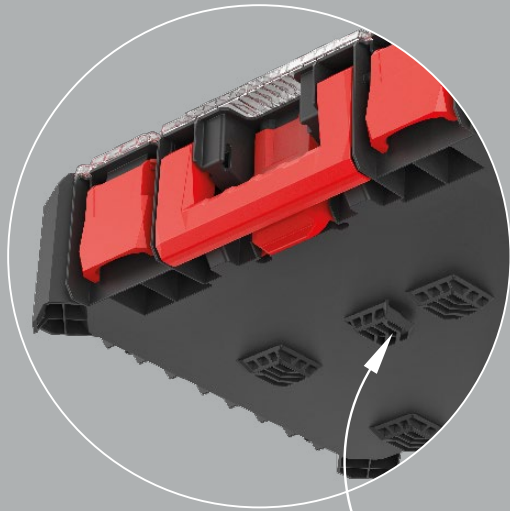

MSX organiser
model
KMX40258, KMX402515

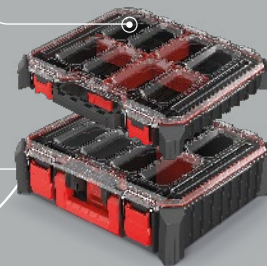

CMX ORGANISER



C Block BRIDGE
organiser
any model

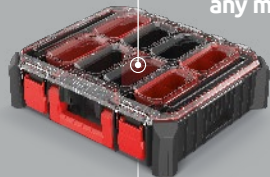

X Block BRIDGE
organiser
any model

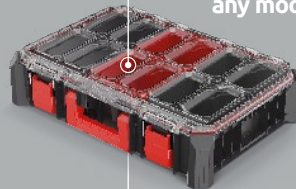

X Block
tool trolley
any model



**Modular
Solution**



C Block
PRO/ALU LOG
tool trolley
any model



X Block
PRO/LOG/TECH
tool trolley
any model



S Block PRO

solid modular system



S BLOCK PRO 45 toolbox

S BLOCK PRO 55 toolbox

S BLOCK PRO 65 toolbox

	KXS4530	KXS5530	KXS6530
colour	S411	S411	S411
mm	450 x 280 x 264	550 x 280 x 264	650 x 280 x 280
kg	~ 30	~ 30	~ 30
pcs	-/-	-/-	-/-
pcs	52	42	30
mm	~ 1930	~ 1880	~ 1780
	interlocking system, plain lid, metal hinges, 1 x tray, ABS latches	interlocking system, plain lid, metal hinges, 1 x tray, ABS latches	interlocking system, plain lid, metal hinges, 1 x tray, 1 x separator, ABS latches

compatible with:
X Block Pro, Alu Log series,
S Block Pro solid toolbox KXS4530,
S Block Alu Log solid toolbox KXSA4530F

compatible with:
X Block Pro, Alu Log series,
S Block Pro solid toolbox KXS5530,
S Block Alu Log solid toolbox KXSA5530F

compatible with:
S Block Pro solid toolbox KXS6530,
S Block Alu Log solid toolbox KXSA6530F

S BLOCK PRO SOLID TOOLBOX:

- Solid gasket
- ABS latches
- Tray
- Removable separator
- Full protection against dust and water IP55

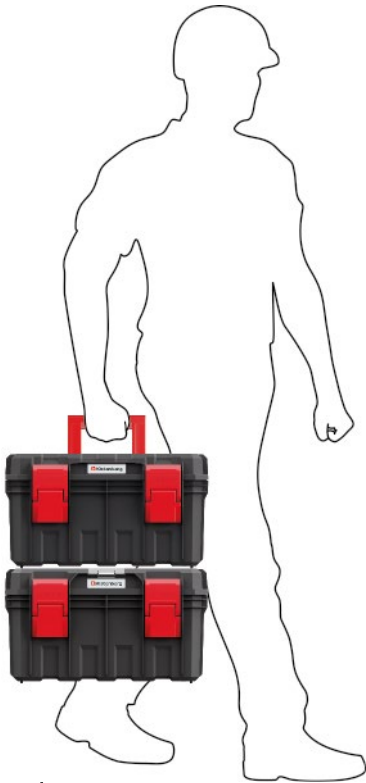

S Block ALU LOG solid modular system



	S BLOCK ALU LOG 45 toolbox	S BLOCK ALU LOG 55 toolbox	S BLOCK ALU LOG 65 toolbox
	KXSA4530F	KXSA5530F	KXSA6530F
colour	S411	S411	S411
mm	450 x 280 x 264	550 x 280 x 264	650 x 280 x 280
kg	~ 30	~ 30	~ 30
pcs	-/-	-/-	-/-
pcs	52	42	30
mm	~ 1930	~ 1880	~ 1780
	interlocking system, metal hinges, 1 x tray, 3 x separators, 4 x boxes	interlocking system, metal hinges, 1 x tray, 4 x separators, 4 x boxes	interlocking system, metal hinges, 1 x tray, 7 x separators , 4 x boxes

S BLOCK ALU LOG SOLID TOOLBOX:

- Solid gasket
- ABS latches
- Tray
- Removable separator
- Polycarbonate cover
- Organiser with separators and boxes in the lid
- Aluminium handle
- Full protection against dust and water **IP55**

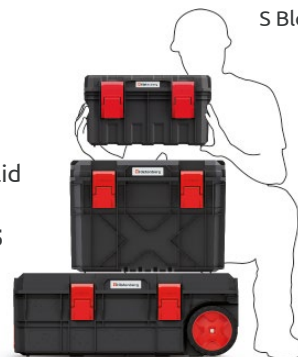

 Kistenberg



interlocking system

The cover of **X Block Pro / Alu Log** series has two additional built-in connectors with metal hinges to fasten:

- S Block Pro solid toolboxes
- S Block Alu Log solid toolboxes

The product is compatible with the Kistenberg KXS4530, KXSA4530F, KXS5530, KXSA5530F

You craft, we store.











interlocking system

Combine any of Pro / Alu Log /series and create your own unique set

Modular Solution

modular system



	MODULAR SOLUTION 15 organiser	MODULAR SOLUTION 15 organiser	MODULAR SOLUTION 30 toolbox	MODULAR SOLUTION 30 toolbox
	KMS553515B	KMS553515S	KMS553530	KMS553530R2
 colour	S411	S411	S411	S411
 mm	517 x 331 x 134	517 x 331 x 134	530 x 355 x 310	530 x 355 x 310
 kg	~ 20	~ 20	~ 50	~ 50
 pcs	3 / -	3 / -	-	-
 pcs	60	60	20	20
 mm	~ 1800	~ 1800	~ 1670	~ 1670
	interlocking system, polycarbonate lid, ABS latches, 8 x boxes, metal hinges	interlocking system, polycarbonate lid, ABS latches, 11 x separators, metal hinges	interlocking system, ABS latches, 2 x separators	interlocking system, ABS latches, metal hinges 2 x separators, 2 x organiser with polycarbonate lid

MODULAR SOLUTION:

- The set includes a mobile module, a toolbox and organisers
- Pressure resistance up to 100 kg
- Large load capacity, easy transport ensuring comfort of use
- Functional internal partitions for arranging the interior space
- Durable ABS latches



Modular Solution

modular system



interlocking system

set 4 in 1



MODULAR SOLUTION 40 tool trolley



MODULAR SOLUTION set

	KMS553540	KMSS553585B
colour	S411	S411
mm	530 x 355 x 390	530 x 355 x 825
kg	~ 50	-
pcs	-	-
pcs	16	8
mm	~ 1750	~ 1770
	ABS latches, 2 x separators, tool holder, interlocking system, metal hinges	tool trolley with separators & removable tool holder, toolbox with separators, ABS latches, organiser with removable boxes and polycarbonate lid



Modular Solution

modular system



	MODULAR SOLUTION 10 basket	MODULAR SOLUTION 10 basket	MODULAR SOLUTION 20 basket	MODULAR SOLUTION 20 basket
	KMS553510	KMS553510S	KMS553520	KMS553520S
	S411	S411	S411	S411
	mm 520 x 327 x 125	mm 520 x 327 x 125	mm 520 x 329 x 210	mm 520 x 329 x 210
	kg ~ 50	kg ~ 50	kg ~ 50	kg ~ 50
	pcs 6 / -	pcs 6 / -	pcs -	pcs 4 / -
	pcs 60	pcs 60	pcs 32	pcs 32
	mm ~ 1790	mm ~ 1790	mm ~ 1800	mm ~ 1800
	interlocking system,	11 x separators, interlocking system,	interlocking system,	2 x separators, interlocking system,

MODULAR SOLUTION:

- Very durable body with reinforced structure
- Possibility of connecting and stacking with Modular Solution system elements and Transport Platform
- Internal separators for customising the interior space
- Wall mountable



Modular Solution modular system



	MODULAR SOLUTION 20 basket	MODULAR SOLUTION organiser	MODULAR SOLUTION tool holder
	KMS553520R7	KMS3020	KMS2530US
colour	S411	S411	S411
mm	520 x 329 x 210	294 x 194 x 60	304 x 85 x 333
kg	~ 50	-	-
pcs	-	10 / 40	- / 12
pcs	32	480	240
mm	~ 1800	~ 1920	~ 1850
	7 x organiser with polycarbonate lid, interlocking system, wall mountable	organiser with polycarbonate lid, ergonomic handle, 6 x separators	universal tool holder, ergonomic handle,





	PLATFORM transport platform	
		KXBP6045
colour		S411
	mm	585 x 440 x 145
	kg	~ 150
	pcs	- / 3
	pcs	42
	mm	~ 1900

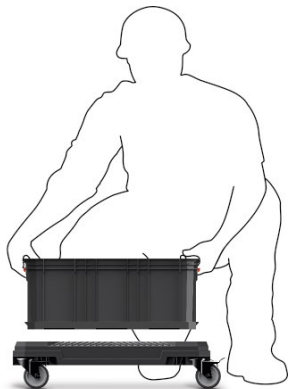

easy
to connect

Platform



X Block series

PRO KXB604030, KXB604040
LOG KXB604030F, KXB604040F
ALU LOG KXBA604030, KXBA604040
TECH KXB604030G, KXB604040G
PRO BASKET KXB604030CS



S Block series

PRO KXS4530, KXS5530
ALU LOG KXSA4530F, KXSA5530F



C Block series

PRO KXC454030
ALU LOG KXCA454030



Modular Solution series

KMS553515B, KMS553515S,
 KMS553530, KMS553530R2,
 KMS553510, KMS553510S,
 KMS553520, KMS553520S

The Kistenberg Platform is compatible with **X Block, C Block, S Block Solid Toolbox, Modular Solution** Equipped with 4 fully rotating metal wheels for easy of movement (two of which have been fitted with brakes). The solid ribbing design ensures a load capacity of up to 150 kg.

Product images are for illustrative purposes only and may differ from the actual product.

You craft, we store.



	PLATFORM
	KXBPFIX
colour	S411
mm	585 x 440 x 70
kg	~ 25 / 150
pcs	- / 5
pcs	70
mm	~ 1900

Platform

The Kistenberg Platform is compatible with **X Block, C Block, S Block Solid Toolbox, Modular Solution** Equipped with 4 mounting holes for easy mounting in a truck to prevent the boxes from overturning when driving. Compatible with KMS553520R7. Wall mountable.











Heavy



transport packing way



transport packing way

	HEAVY toll trolley	HEAVY toll trolley
	KHVV	KHVWM
 colour	S411	S411
 mm	450 x 360 x 640 / 380	450 x 360 x 640 / 380
 kg	~ 25	~ 25
 pcs	-	-
 pcs	24	24
 mm	~ 1670	~ 1670
	deep tray, ABS latches, 2 x separators, 2 x boxes, compact packing 3in1	deep tray, metal latches, 2 x separators, 2 x boxes, compact packing 3in1

HEAVY TOOL TROLLEY:

- Large wheels for easy transport of the box
- Modular body made of reinforced polymer blend
- Reinforced wall structure
- Durable ABS latches
- Functional tray inside
- Transparent organisers with a polycarbonate covers
- Separators and boxes in the organiser
- Can be disassembled for transport



You craft, we store.

Heavy



	HEAVY 45 tool case	HEAVY 60 tool case	HEAVY 45 toolbox	HEAVY 60 toolbox
	KHV453520	KHV603520	KHV453535	KHV603535
colour	S411	S411	S411	S411
mm	445 x 360 x 216	585 x 360 x 217	445 x 360 x 337	585 x 360 x 337
kg	~ 25	~ 25	~ 25	~ 25
pcs	-	-	-	-
pcs	48	32	30	20
mm	~ 1840	~ 1840	~ 1800	~ 1800
	8 x removable separators, 2 handles for easy carrying, two-component ABS latches, tool organiser set in the lid,	8 x removable separators, 2 handles for easy carrying, ABS latches, tool organiser set in the lid	ABS latches, deep tray	ABS latches, deep tray

HEAVY:

- Body made of reinforced polymer blend
- Reinforced wall structure
- Ergonomic ABS handles
- Solid gasket ensures that the product is dustproof and water resistant
- Functional storage space



You craft, we store.



You craft, we store.

Heavy



HEAVY:

- Body made of reinforced polymer blend
- Reinforced wall structure
- Ergonomic ABS handles
- Durable ABS latches
- Gasket for water and dust resistance
- Functional storage space lined with foam











	HEAVY 45 tool case	HEAVY 60 tool case
	KHV453520P	KHV603520P
colour	S411	S411
mm	445 x 360 x 216	585 x 360 x 217
kg	~ 25	~ 25
pcs	-	-
pcs	48	32
mm	~ 1840	~ 1840
	foam inside, 2 handles for easy carrying, two-component ABS latches	foam inside, 2 handles for easy carrying, ABS latches



Heavy



	HEAVY 45 tool case	HEAVY 60 tool case	HEAVY 45 toolbox	HEAVY 60 toolbox
	KHV453520M	KHV603520M	KHV453535M	KHV603535M
 colour	S411	S411	S411	S411
 mm	445 x 360 x 216	585 x 360 x 217	445 x 360 x 337	585 x 360 x 337
 kg	~ 25	~ 25	~ 25	~ 25
 pcs	-	-	-	-
 pcs	48	32	30	20
 mm	~ 1840	~ 1840	~ 1800	~ 1800
	8 x removable separators, 2 handles for easy carrying, metal latches, tool organiser set in the lid	8 x removable separators, 2 handles for easy carrying, metal latches, tool organiser set in the lid	metal latches, deep tray	metal latches, deep tray

HEAVY:

- Body made of reinforced polymer blend
- Reinforced wall structure
- Ergonomic ABS handles
- Strong galvanized steel latches
- Functional storage space



You craft, we store.

Heavy



	HEAVY 45 toolbox	HEAVY 60 toolbox	HEAVY 45 toolbox	HEAVY 60 toolbox
	KHV453535F	KHV603535F	KHV453535FM	KHV603535FM
colour	S411	S411	S411	S411
mm	445 x 360 x 337	585 x 360 x 337	445 x 360 x 337	585 x 360 x 337
kg	~ 25	~ 25	~ 25	~ 25
pcs	-	-	-	-
pcs	30	20	30	20
mm	~ 1800	~ 1800	~ 1800	~ 1800
	plastic handle, ABS latches, organiser with polycarbonate cover set in the lid, deep tray, 2 x boxes, 2 x seperators	plastic handle, ABS latches, organiser with polycarbonate cover set in the lid, deep tray, 4 x boxes, 1 x seperator	plastic handle, metal latches, organiser with polycarbonate cover set in the lid, deep tray, 2 x boxes, 2 x seperators	plastic handle, metal latches, organiser with polycarbonate cover set in the lid, deep tray, 4 x boxes, 1 x seperator



HEAVY:

- Body made of reinforced polymer blend
- Reinforced wall structure
- Ergonomic ABS handles
- Durable ABS latches / metal latches
- Functional tray



Heavy



	HEAVY 45 toolbox	HEAVY 60 toolbox	HEAVY 45 toolbox	HEAVY 60 toolbox
	KHVA453535BS	KHVA603535BS	KHVA453535BSM	KHVA603535BSM
colour	S411	S411	S411	S411
mm	445 x 360 x 337	585 x 360 x 337	445 x 360 x 337	585 x 360 x 337
kg	~ 25	~ 25	~ 25	~ 25
pcs	-	-	-	-
pcs	30	20	30	20
mm	~ 1800	~ 1800	~ 1800	~ 1800
	deep tray, alu handle, ABS latches, organiser in the lid with 3 x separators and 4 x boxes, polycarbonate cover	deep tray, alu handle, ABS latches, organiser in the lid with 4 x separators and 5 x boxes, polycarbonate cover	deep tray, alu handle, metal latches, organiser in the lid with 3 x separators and 4 x boxes, polycarbonate cover	deep tray, alu handle, metal latches, organiser in the lid with 4 x separators and 5 x boxes, polycarbonate cover

HEAVY:

- Body made of reinforced polymer blend
- Reinforced wall structure
- Durable large aluminum handle
- Durable ABS latches / metal latches
- Functional tray inside
- Large transparent organiser with a polycarbonate covers
- Separators and boxes in the organiser



Heavy



	HEAVY 40 tool case	HEAVY 40 tool case	HEAVY 40 tool case	HEAVY 40 tool case
	KHV40	KHV40P	KHV40S	KHV40B
colour	S411	S411	S411	S411
mm	384 x 335 x 144	384 x 335 x 144	384 x 335 x 144	384 x 335 x 144
kg	~ 10	~ 10	~ 10	~ 10
pcs	4 / -	4 / -	4 / -	4 / -
pcs	80	80	80	80
mm	~ 1790	~ 1790	~ 1790	~ 1790
i	2 x fastening belts inside, ergonomic handle	foam inside, ergonomic handle	organiser in the lid with 4 x separators and polycarbonate cover, 2 x fastening belts inside	organiser in the lid with 7 x boxes and polycarbonate cover, 2 x fastening belts inside





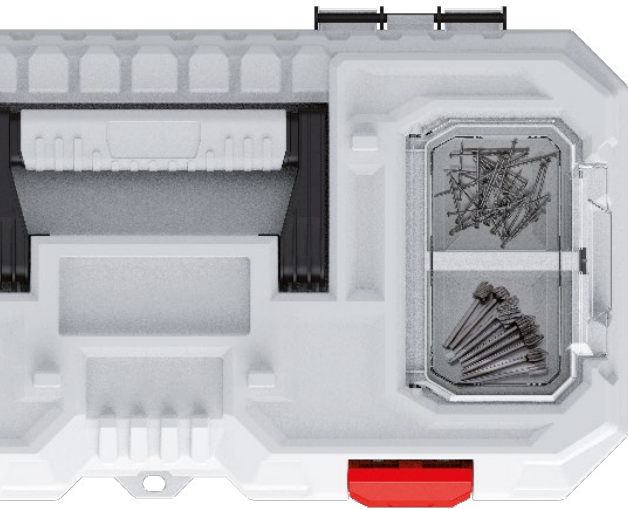

HEAVY:

- Body made of a mixture of increased strength polymers
- Ergonomic handle
- Ergonomic fasteners



Titan Plus toolbox



	TITAN PLUS 50 toolbox	TITAN PLUS 55 toolbox
	KTIP5025	KTIP5530
colour	3020 4C	3020 4C
 mm	496 x 258 x 240	554 x 286 x 276
 kg	~ 15	~ 20
 pcs	-	-
 pcs	52	36
 mm	~ 1830	~ 1800
	two- component handle, ABS latches, rubber corners	two- component handle, ABS latches, rubber corners

TITAN PLUS:

- Body made of a durable polymer blend
- Ergonomic handle
- Durable ABS latches
- Transparent organisers with a polycarbonate lids
- Elastomer corners
- Inner tray

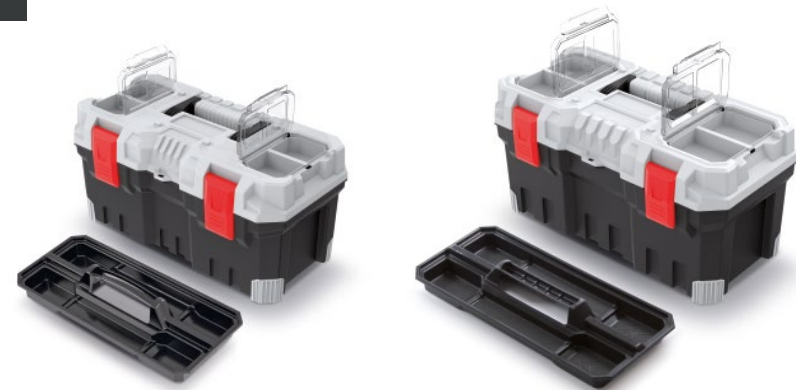

You craft, we store.

Titan Plus toolbox



	TITAN PLUS 50 toolbox	TITAN PLUS 55 toolbox	TITAN PLUS 75 toolbox
	KTIPA5025	KTIPA5530	KTIPA7530
colour	3020 4C	3020 4C	3020 4C
mm	496 x 258 x 240	554 x 286 x 276	752 x 300 x 304
kg	~ 15	~ 20	~ 30
pcs	-	-	-
pcs	52	36	20
mm	~ 1830	~ 1800	~ 1670
	alu handle, ABS latches, rubber corners	alu handle, ABS latches, rubber corners	alu handle, ABS latches, rubber corners

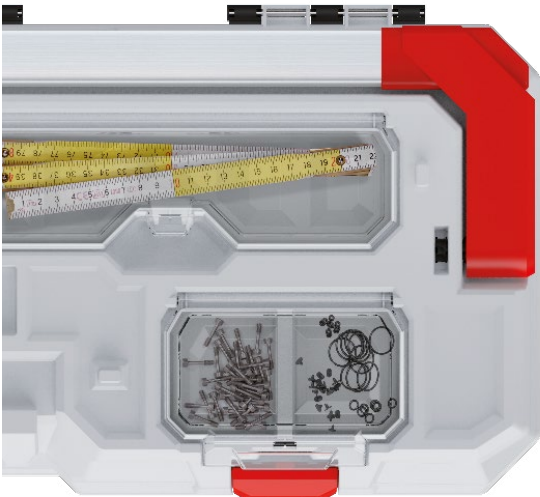













TITAN PLUS:

- Body made of a durable polymer blend
- Durable aluminum handle
- Durable ABS latches
- Transparent organisers with a polycarbonate covers
- Elastomer corners
- Inner tray
- Large capacity



Optima toolbox



	OPTIMA 30 toolbox	OPTIMA 30 toolbox	OPTIMA 40 toolbox	OPTIMA 40 toolbox	OPTIMA 50 toolbox	OPTIMA 55 toolbox
	KOP3020N	KOP3020	KOP4020N	KOP4020	KOP5025	KOP5530
colour						
 mm	296 x 178 x 153	296 x 178 x 153	360 x 195 x 183	360 x 195 x 183	470 x 256 x 238	540 x 278 x 269
 kg	~ 10	~ 10	~ 10	~ 10	~ 13	~ 20
 pcs	-	-	-	-	-	-
 pcs	216	216	108	108	52	36
 mm	~ 1940	~ 1940	~ 1770	~ 1770	~ 1860	~ 1700
	plastic handle, tray	organiser in the lid, plastic handle, tray	plastic handle, tray	organiser in the lid, plastic handle, tray	organiser in the lid, plastic handle, tray, two-component ABS latches,	organiser in the lid, plastic handle, tray, two-component ABS latches,

OPTIMA:

- Body made of a mixture of increased strength polymers
- Organisers with durable polycarbonate lids
- Functional tray inside
- Ergonomic handle



You craft, we store.

Optima toolbox



OPTIMA 50 toolbox

OPTIMA 55 toolbox

OPTIMA 60 toolbox

	KOPA5025	KOPA5530	KOPA6030
colour	4C	4C	4C
mm	470 x 256 x 238	540 x 278 x 269	586 x 296 x 305
kg	~ 13	~ 20	~ 25
pcs	-	-	-
pcs	52	36	36
mm	~ 1860	~ 1700	~ 1930
	organiser in the lid, alu handle, tray, two-component ABS latches,	organiser in the lid, alu handle, tray, two-component ABS latches,	organiser in the lid, alu handle, tray, two-component ABS latches,



OPTIMA:

- Body made of a mixture of increased strength polymers
- Transparent organisers with a polycarbonate cover
- Functional tray inside
- Solid, ergonomic aluminum handle
- Durable two-component fasteners made of ABS and elastomer

Optima toolbox









OPTIMA 50 toolbox



OPTIMA 55 toolbox



OPTIMA 60 toolbox

	KOPA5025S	KOPA5530S	KOPA6030S
colour	4C	4C	4C
 mm	470 x 256 x 238	540 x 278 x 269	586 x 296 x 305
 kg	~ 13	~ 20	~ 25
 pcs	-	-	-
 pcs	52	36	36
 mm	~ 1860	~ 1700	~ 1930
	organiser in the lid, alu handle, tray, two-component ABS latches, 5 x separators, space for long items in the lid up to 320 mm	organiser in the lid, alu handle, tray, two-component ABS latches, 6 x separators, space for long items in the lid up to 375 mm	organiser in the lid, alu handle, tray, two-component ABS latches, 6 x separators, space for long items in the lid up to 375 mm

OPTIMA:

- Body made of a mixture of increased strength polymers
- Large organiser with partitions and a durable polycarbonate lid
- Functional tray inside
- Solid, ergonomic aluminum handle
- Durable two-component latches made of ABS and elastomer



You craft, we store.

Optima toolbox



	OPTIMA 50 toolbox	OPTIMA 55 toolbox	OPTIMA 60 toolbox
	KOPA5025SM	KOPA5530SM	KOPA6030SM
colour	4C	4C	4C
mm	470 x 256 x 238	540 x 278 x 269	586 x 296 x 305
kg	~ 13	~ 20	~ 25
pcs	-	-	-
pcs	52	36	36
mm	~ 1860	~ 1700	~ 1930
	organiser with separators in the lid, alu handle, metal latches, tray, 5 x seperators, space for long items in the lid up to 320 mm	organiser with separators in the lid, alu handle, metal latches, tray, 6 x seperators, space for long items in the lid up to 375 mm	organiser with separators in the lid, alu handle, metal latches, tray, 6 x seperators, space for long items in the lid up to 375 mm



OPTIMA:

- Body made of a mixture of increased strength polymers
- Large organiser with separators and a durable polycarbonate lid
- Functional tray inside
- Solid, ergonomic aluminum handle
- Durable galvanized steel latches



Optima toolbox









OPTIMA 50 toolbox



OPTIMA 55 toolbox



OPTIMA 60 toolbox

	KOPA5025B	KOPA5530B	KOPA6030B
colour	4C	4C	4C
 mm	470 x 256 x 238	540 x 278 x 269	586 x 296 x 305
 kg	~ 13	~ 20	~ 25
 pcs	-	-	-
 pcs	52	36	36
 mm	~ 1860	~ 1700	~ 1930
	organiser in the lid, alu handle, tray, two-component ABS latches, 7 x boxes, space for long items in the lid up to 320 mm	organiser in the lid, alu handle, tray, two-component ABS latches, 6 x boxes, space for long items in the lid up to 375 mm	organiser in the lid, alu handle, tray, two-component ABS latches , 6 x boxes, space for long items in the lid up to 375 mm

OPTIMA:

- Body made of a mixture of increased strength polymers
- Large organiser with boxes and a durable polycarbonate lid
- Functional tray inside
- Durable, ergonomic aluminum handle
- Durable two-component latches made of ABS and elastomer



You craft, we store.

Optima toolbox



	OPTIMA 50 toolbox	OPTIMA 55 toolbox	OPTIMA 60 toolbox
	KOPA5025BM	KOPA5530BM	KOPA6030BM
	4C	4C	4C
mm	470 x 256 x 238	540 x 278 x 269	586 x 296 x 305
kg	~ 13	~ 20	~ 25
pcs	-	-	-
pcs	52	36	36
mm	~ 1860	~ 1700	~ 1930
	organiser in the lid, alu handle, tray, metal latches, 7 x boxes, space for long items in the lid up to 320 mm	organiser in the lid, alu handle, tray, metal latches, 6 x boxes, space for long items in the lid up to 375 mm	organiser in the lid, alu handle, tray, metal latches, 6 x boxes, space for long items in the lid up to 375 mm



OPTIMA:

- Body made of a mixture of increased strength polymers
- Large organiser with boxes and a durable polycarbonate lid
- Functional tray inside
- Solid, ergonomic aluminum handle
- Durable galvanized steel latches



Evo toolbox



new

	EVO 30 toolbox	EVO 30 toolbox	EVO 40 toolbox	EVO 40 toolbox	EVO 50 toolbox	EVO 50 toolbox	EVO 55 toolbox
	KEV3020N	KEV3020	KEV4020N	KEV4020	KEV5025N	KEV5025	KEV5530
colour	3020	3020	3020	3020	3020	3020	3020
mm	269 x 177 x 155	269 x 177 x 155	360 x 193 x 186	360 x 193 x 186	476 x 258 x 226	476 x 260 x 256	548 x 274 x 286
kg	~ 10	~ 10	~ 10	~ 10	~ 12	~ 12	~ 20
pcs	-	-	-	-	-	-	-
pcs	216	216	108	108	52	52	36
mm	~ 1940	~ 1940	~ 1770	~ 1770	~ 1700	~ 1880	~ 1820
i	ABS latches, tray	organiser in the lid, tray, ABS latches	ABS latches, tray	organiser with separators in the lid, tray, ABS latches	ABS latches, tray	2 x organisers with 2 x separators in the lid, tray, ABS latches	2 x organisers with 2 x separators in the lid, tray, ABS latches



You craft, we store.

Evo toolbox



EVO:

- Body made of a mixture of increased strength polymers
- Organisers with separators and durable polycarbonate lids
- Functional tray inside
- Ergonomic handle
- Durable aluminum latches

Product images are for illustrative purposes only and may differ from the actual product.



EVO 50 toolbox



EVO 55 toolbox

	KEV5025AL	KEV5530AL
colour	3020	3020
mm	476 x 260 x 256	548 x 274 x 286
kg	~ 12	~ 20
pcs	-	-
pcs	52	36
mm	~ 1880	~ 1820
	2 x organisers with 2 x separators in the lid, tray, alu latches	2 x organisers with 2 x separators in the lid, tray, alu latches



Evo toolbox









EVO 50 toolbox



EVO 55 toolbox



EVO 60 toolbox

	KEVA5025S	KEVA5530S	KEVA6030S
colour	3020	3020	3020
 mm	476 x 260 x 256	548 x 274 x 286	595 x 288 x 308
 kg	~ 12	~ 20	~ 25
 pcs	-	-	-
 pcs	52	36	36
 mm	~ 1880	~ 1820	~ 1940
	organiser with 5 x separators in the lid, alu handle, tray, ABS latches	organiser with 6 x separators in the lid, alu handle, tray, ABS latches	organiser with 7 x separators in the lid, alu handle, tray, ABS latches

EVO:

- Body made of a mixture of increased strength polymers
- Large organiser with separators and a durable polycarbonate lid
- Functional tray inside
- Solid, ergonomic aluminum handle
- Durable ABS latches

Product images are for illustrative purposes only and may differ from the actual product.



You craft, we store.

Evo toolbox



	EVO 50 toolbox	EVO 55 toolbox	EVO 60 toolbox
	KEVA5025SAL	KEVA5530SAL	KEVA6030SAL
colour	3020	3020	3020
mm	476 x 260 x 256	548 x 274 x 286	595 x 288 x 308
kg	~ 12	~ 20	~ 25
pcs	-	-	-
pcs	52	36	36
mm	~ 1880	~ 1820	~ 1940
i	organiser with 5 x separators in the lid, alu handle, tray, alu latches	organiser with 6 x separators in the lid, alu handle, tray, alu latches	organiser with 7 x separators in the lid, alu handle, tray, alu latches

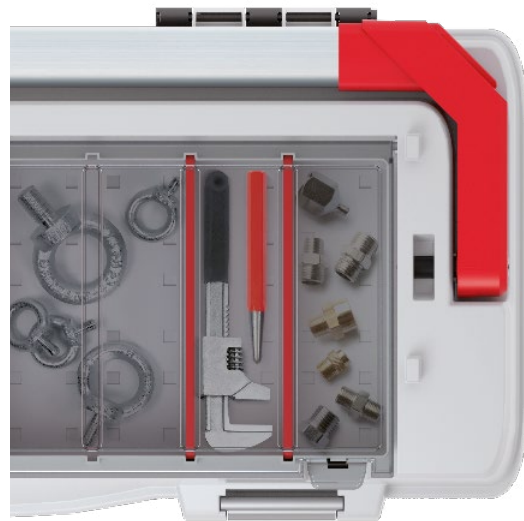

EVO:









- Body made of a mixture of increased strength polymers
- Large organiser with separators and a durable polycarbonate lid
- Functional tray inside
- Solid, ergonomic aluminum handle
- Durable aluminium latches

Product images are for illustrative purposes only and may differ from the actual product.



Evo toolbox



	EVO 50 toolbox	EVO 55 toolbox	EVO 60 toolbox
	KEVA5025B	KEVA5530B	KEVA6030B
 colour	3020	3020	3020
 mm	476 x 260 x 256	548 x 274 x 286	595 x 288 x 308
 kg	~ 12	~ 20	~ 25
 pcs	-	-	-
 pcs	52	36	36
 mm	~ 1880	~ 1820	~ 1940
	organiser with 9 x boxes in the lid, alu handle, tray, ABS latches	organiser with 11 x boxes in the lid, alu handle, tray, ABS latches	organiser with 11 x boxes in the lid, alu handle, tray, ABS latches

EVO:

- Body made of a mixture of increased strength polymers
- Large organiser with boxes and a durable polycarbonate lid
- Functional tray inside
- Solid, ergonomic aluminum handle
- Durable ABS latches

Product images are for illustrative purposes only and may differ from the actual product.



You craft, we store.

Evo toolbox



EVO 50 toolbox

EVO 55 toolbox

EVO 60 toolbox

	KEVA5025BAL	KEVA5530BAL	KEVA6030BAL
colour	3020	3020	3020
mm	476 x 260 x 256	548 x 274 x 286	595 x 288 x 308
kg	~ 12	~ 20	~ 25
pcs	-	-	-
pcs	52	36	36
mm	~ 1880	~ 1820	~ 1940
	organiser with 9 x boxes in the lid, alu handle, tray, alu latches	organiser with 11 x boxes in the lid, alu handle, tray, alu latches	organiser with 11 x boxes in the lid, alu handle, tray, alu latches

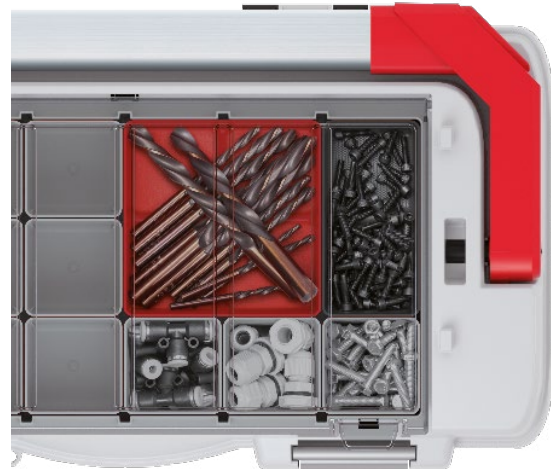

EVO:

- Body made of a mixture of increased strength polymers
- Large organiser with boxes and a durable polycarbonate lid
- Functional tray inside
- Solid, ergonomic aluminum handle
- Durable aluminium latches

Product images are for illustrative purposes only and may differ from the actual product.



Dark toolbox

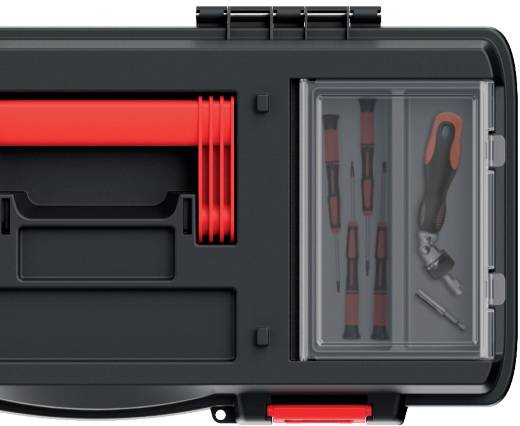









new
DARK 30 toolbox

new
DARK 40 toolbox

new
DARK 50 toolbox

new
DARK 50 toolbox

new
DARK 55 toolbox

	KDR3020N	KDR4020N	KDR5025N	KDR5025	KDR5530
	S411	S411	S411	S411	S411
 mm	269 x 177 x 155	360 x 193 x 186	476 x 258 x 226	476 x 258 x 226	548 x 273 x 260
 kg	~ 10	~ 10	~ 12	~ 12	~ 19
 pcs	-	-	-	-	-
 pcs	216	108	52	52	36
 mm	~ 1940	~ 1770	~ 1700	~ 1700	~ 1680
	ABS latches, tray	ABS latches, tray	ABS latches, tray	organiser in the lid, tray, ABS latches	organiser in the lid, tray, ABS latches

DARK:

- Body made of a mixture of increased strength polymers
- Organisers with transparent lids
- Functional tray inside
- Ergonomic handle
- Durable ABS latches



Aptop PLUS toolbox



	APTOP PLUS 50 toolbox	APTOP PLUS 55 toolbox	APTOP PLUS 60 toolbox
	KAP5025AL	KAP5530AL	KAP6030AL
colour	3020	3020	3020
mm	458 x 257 x 245	550 x 267 x 277	598 x 286 x 327
kg	~ 13	~ 20	~ 25
pcs	-	-	-
pcs	52	42	30
mm	~ 1850	~ 1800	~ 1750
	aluminium latches, anodised aluminium handle, long tray inside, transparent polycarbonate organiser in the lid, loop for a lock	aluminium latches, anodised aluminium handle, long tray inside, transparent polycarbonate organiser in the lid, loop for a lock	aluminium latches, anodised aluminium handle, long tray inside, transparent polycarbonate organiser in the lid, loop for a lock









APTOP PLUS:

- Body made of a mixture of increased strength polymers
- Large organiser with boxes and a durable polycarbonate lid
- Functional tray inside
- Solid, ergonomic aluminum handle
- Aluminium handle



Caliber toolbox



	CALIBER 30 toolbox	CALIBER 40 toolbox	CALIBER 50 toolbox	CALIBER 55 toolbox	CALIBER 60 toolbox
	KCR3020	KCR4020	KCR5025	KCR5530	KCR6030
 colour	S411	S411	S411	S411	S411
 mm	300 x 167 x 150	400 x 200 x 186	460 x 257 x 227	550 x 267 x 270	597 x 285 x 320
 kg	~ 6	~ 8,5	~ 11,5	~19,0	~21,0
 pcs	-	-	-	-	-
 pcs	240	108	60	42	30
 mm	~ 1930	~ 1810	~ 1950	~ 1750	~ 1720
	plastic handle, plastic latches, tray inside, loop for a lock	plastic handle, plastic latches, tray inside, loop for a lock	plastic handle, plastic latches, tray inside, loop for a lock	transparent organiser in the lid, tray inside, loop for a lock	transparent organiser in the lid, tray inside, loop for a lock



CALIBER:

- Body made of a mixture of increased strength polymers
- Organisers with transparent lids
- Functional tray inside
- Ergonomic handle



You craft, we store.

Smart toolbox



	SMART 32 toolbox	SMART 40 toolbox	SMART 50 toolbox	SMART toolbox set	SMART 50 toolbox
	KSM32	KSM40	KSM50	KSMS40	KMA50F
	3020 4C	3020 4C	3020 4C	3020 4C	4C
mm	328 x 178 x 160	380 x 234 x 225	500 x 251 x 243	380 x 234 x 225	500 x 251 x 243
kg	~ 6	~ 8,5	~ 12	~ 6 / ~ 8,5	~ 12
pcs	-	-	-	-	-
pcs	154	80	49	80	49
mm	~ 1880	~ 1900	~ 1800	~ 1900	~ 1810
	ABS latches, ergonomic handle, tray	ABS latches, ergonomic handle, tray	ABS latches, ergonomic handle, tray	ABS latches, ergonomic handle, smart set 2in1, trays	ABS latches, ergonomic alu handle, tray, organiser with 5 x boxes in the lid







SMART:

- Modern design
- Ergonomic handle
- Durable ABS fasteners
- Inner tray



Cargo PLUS tool tray



	CARGO PLUS tool tray			CARGO PLUS tool tray			X BLOCK cargo
	KCA30	KCA40	KCA50	KCA30S	KCA40S	KCA50S	KXBC
 colour	S411	S411	S411	S411	S411	S411	S411
 mm	300 x 300 x 133	395 x 295 x 190	495 x 345 x 210	300 x 300 x 133	395 x 295 x 190	495 x 345 x 210	343 x 197 x 100
 kg	~ 10	~ 15	~ 20	~ 10	~ 15	~ 20	~ 8
 pcs	10 / 40	12 / 24	- / 12	10 / 40	12 / 24	- / 12	5 / 30
 pcs	400	288	144	400	288	144	540
 mm	~ 1700	~ 1860	~ 1700	~ 1700	~ 1860	~ 1700	~ 1700
 i	ergonomic handle			ergonomic handle, separators			

CARGO:

- Body made of a mixture of increased strength polymers
- Spacious chambers
- Ergonomic handle
- Functional partitions



You craft, we store.

Cargo tool tray



CARGO:

- Body made of a mixture of increased strength polymers
- Spacious chambers
- Ergonomic handle made of anodized aluminum













	CARGO tool tray	CARGO tool tray
	KCAA40	KCAA50
colour	S411	S411
mm	400 x 220 x 170	496 x 296 x 231
kg	~ 12	~ 17
pcs	- / 38	- / 8
	608	96
mm	~ 1950	~ 1700
	alu handle	alu handle



Titan

organiser



	TITAN 30 organiser	TITAN 40 organiser	TITAN 60 organiser
	KTI3030S	KTI4040S	KTI6040S
 colour	 CG6U	 CG6U	 CG6U
 mm	280 x 280 x 110	390 x 390 x 110	598 x 390 x 110
 kg	~ 10	~ 20	~ 20
 pcs	6 / 12	5 / -	5 / -
 pcs	144	90	60
 mm	~ 1860	~ 1800	~ 1800
 i	polycarbonate lid, plastic handle, 5 x separators, rubber corners	polycarbonate lid, plastic handle, 11 x separators, rubber corners	polycarbonate lid, plastic handle, 20 x separators, rubber corners

TITAN:

- Durable polymer blend body
- Elastomer corners
- Ergonomic handle
- Transparent polycarbonate lid
- ABS fasteners
- Functional separators



You craft, we store.

Titan organiser



	TITAN 30 organiser	TITAN 40 organiser	TITAN 50 organiser
	KT13030B	KT14040B	KT16040B
colour			
mm	280 x 280 x 110	390 x 390 x 110	598 x 390 x 110
kg	~ 10	~ 20	~ 20
pcs	6 / 12	5 / -	5 / -
pcs	144	90	60
mm	~ 1860	~ 1800	~ 1800
	polycarbonate lid, plastic handle, 5 x boxes, rubber corners	polycarbonate lid, plastic handle, 9 x boxes, rubber corners	polycarbonate lid, plastic handle, 15 x boxes, rubber corners



TITAN:

- Durable polymer blend body
- Elastomer corners
- Ergonomic handle
- Transparent polycarbonate lid
- ABS fasteners
- Functional boxes









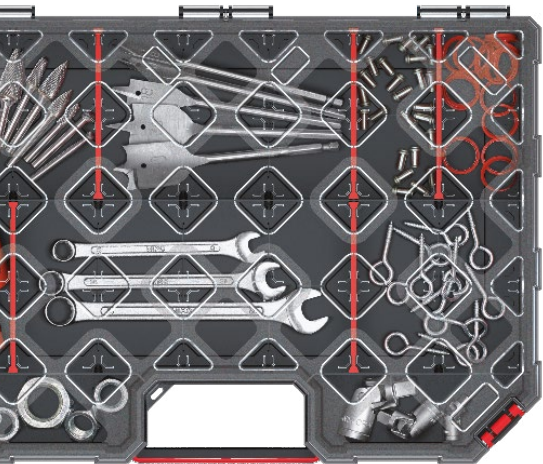

Product images are for illustrative purposes only and may differ from the actual product.



Tager

Carbo Plus



	TAGER CARBO PLUS 30 organiser low	TAGER CARBO PLUS 40 organiser low	TAGER CARBO PLUS 60 organiser low
	KTGC30256S	KTGC40306S	KTGC60406S
 colour			
 mm	284x243x60	390x284x60	577x390x60
 kg	-	-	-
 pcs	10 / -	5 / -	5 / -
 pcs	360	240	120
 mm	~ 1900	~ 1920	~ 1850
	polycarbonate lid, 4 x separators, two-component handle	polycarbonate lid, 12 x separators, two-component handle	polycarbonate lid, 22 x separators, two-component handle

TAGER:

- Body made of a mixture of increased strength polymers
- Ergonomic handle
- Transparent polycarbonate lid
- Functional partitions
- Durable fasteners



You craft, we store.

Tager

Carbo Plus



	TAGER CARBO PLUS 30 organiser high	TAGER CARBO PLUS 40 organiser high	TAGER CARBO PLUS 60 organiser high
	KTGC302510S	KTGC403010S	KTGC604010S
colour			
mm	284 x 243 x 105	390 x 284 x 105	577 x 390 x 105
kg	-	-	-
pcs	5 / -	5 / -	5 / -
pcs	180	120	60
mm	~ 1680	~ 1700	~ 1770
i	polycarbonate lid, 4 x separators, two-component handle	polycarbonate lid, 12 x separators, two-component handle	polycarbonate lid, 22 x separators, two-component handle

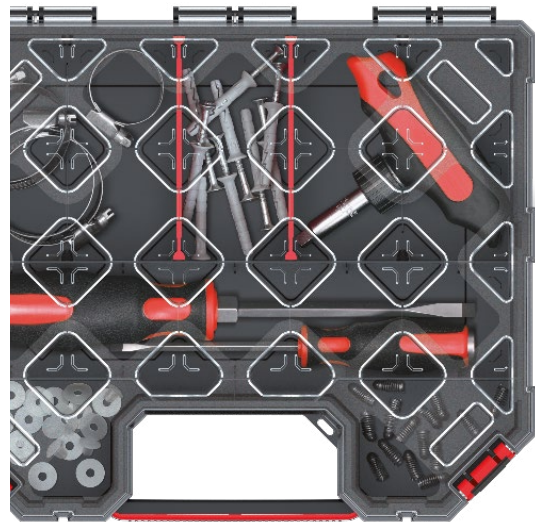

TAGER:









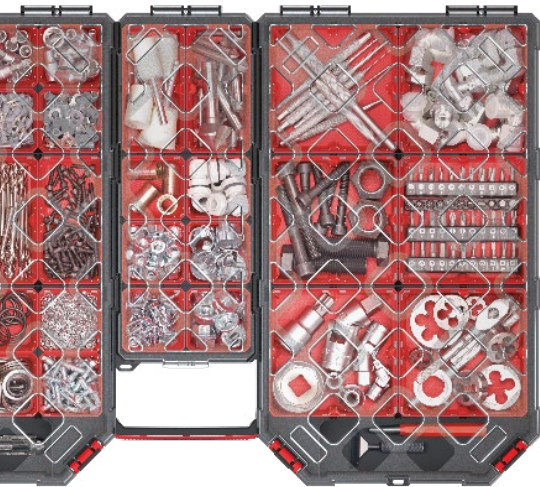

- Body made of a mixture of increased strength polymers
- Ergonomic handle
- Transparent polycarbonate lid
- Functional partitions
- Durable fasteners
- Lots of storage space



Tager

Carbo Plus



	TAGER CARBO PLUS 30 organiser low	TAGER CARBO PLUS 40 organiser low	TAGER CARBO PLUS 60 organiser low
	KTGC30256B	KTGC40306B	KTGC60406B
 colour			
 mm	284x243x60	390x284x60	577x390x60
 kg	-	-	-
 pcs	10 / -	5 / -	5 / -
 pcs	360	240	120
 mm	~ 1900	~ 1920	~ 1850
	polycarbonate lid, 7 x boxes, two-component handle	polycarbonate lid, 12 x boxes, two-component handle	polycarbonate lid, 27 x boxes, two-component handle

TAGER:

- Body made of a mixture of increased strength polymers
- Ergonomic handle
- Transparent polycarbonate lid
- Functional bins
- Durable fasteners
- Lots of storage space



You craft, we store.

Tager

Carbo Plus

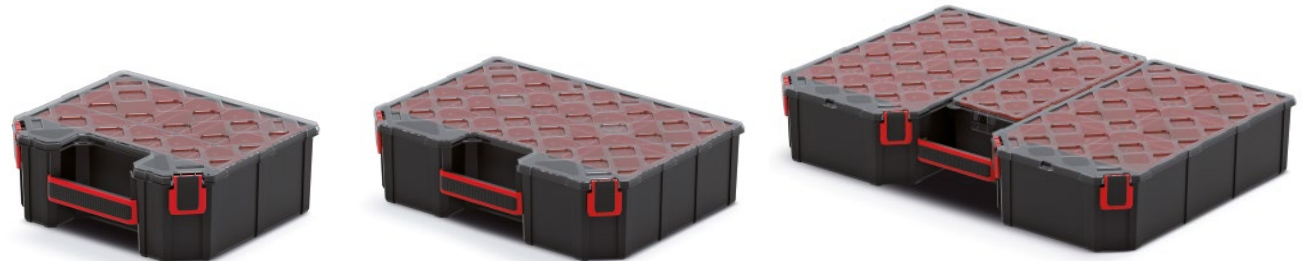

	TAGER CARBO PLUS 30 organiser high	TAGER CARBO PLUS 40 organiser high	TAGER CARBO PLUS 60 organiser high
	KTGC302510B	KTGC403010B	KTGC604010B
	CG6U	CG6U	CG6U
mm	284 x 243 x 105	390 x 284 x 105	577 x 390 x 105
kg	-	-	-
pcs	5 /-	5 /-	5 /-
pcs	180	120	60
mm	~ 1680	~ 1700	~ 1770
	polycarbonate lid, 7 x boxes, two-component handle	polycarbonate lid, 12 x boxes, two-component handle	polycarbonate lid, 27 x boxes, two-component handle

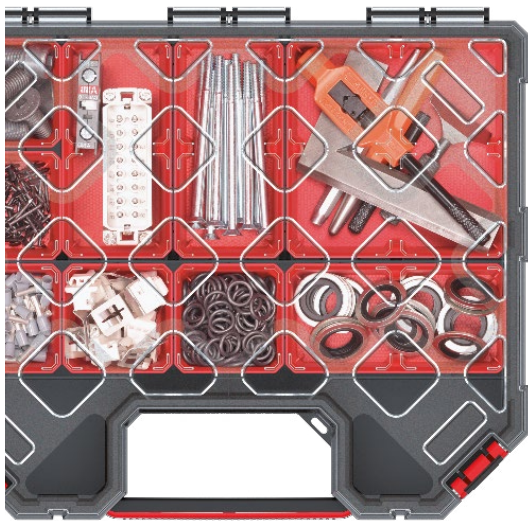

TAGER:











- Body made of a mixture of increased strength polymers
- Ergonomic handle
- Transparent polycarbonate lid
- Functional bins
- Durable fasteners
- Lots of storage space



Tager

Carbo Plus



	TAGER CARBO PLUS 30 organiser low	TAGER CARBO PLUS 40 organiser low	TAGER CARBO PLUS 60 organiser low
	KTGC30256BS	KTGC40306BS	KTGC60406BS
 colour	 CG6U	 CG6U	 CG6U
 mm	284x243x60	390x284x60	577x390x60
 kg	-	-	-
 pcs	10 / -	5 / -	5 / -
 pcs	360	240	120
 mm	~ 1900	~ 1920	~ 1850
 i	polycarbonate lid, 4 x separators and 3 x boxes, two-component handle	polycarbonate lid, 6 x separators and 6 x boxes, two-component handle	polycarbonate lid, 6 x separators and 22 x boxes, two-component handle

TAGER:

- Body made of a mixture of increased strength polymers.
- Ergonomic handle.
- Transparent polycarbonate lid.
- Functional bins and partitions.
- Durable fasteners.
- Lots of storage space.



You craft, we store.

Tager

Carbo Plus

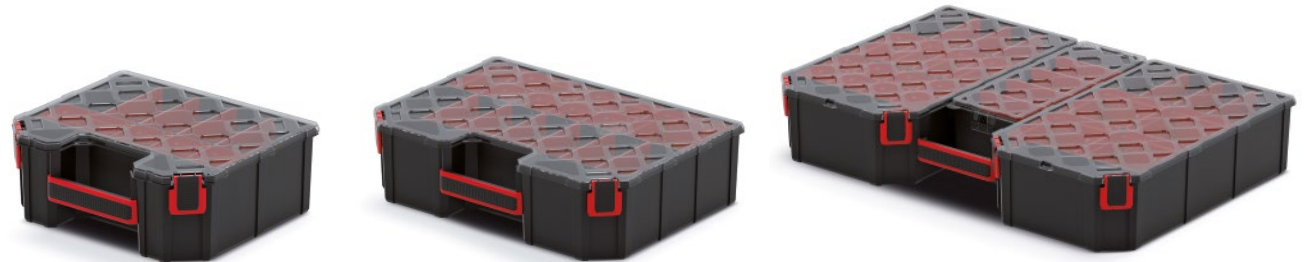

	TAGER CARBO PLUS 30 organiser high	TAGER CARBO PLUS 40 organiser high	TAGER CARBO PLUS 60 organiser high
	KTGC302510BS	KTGC403010BS	KTGC604010BS
	CG6U	CG6U	CG6U
mm	284 x 243 x 105	390 x 284 x 105	577 x 390 x 105
kg	-	-	-
pcs	5 /-	5 /-	5 /-
pcs	180	120	60
mm	~ 1680	~ 1700	~ 1770
	polycarbonate lid, 4 x separators and 3 x boxes, two-component handle	polycarbonate lid, 6 x separators and 6 x boxes, two-component handle	polycarbonate lid, 6 x separators and 22 x boxes, two-component handle

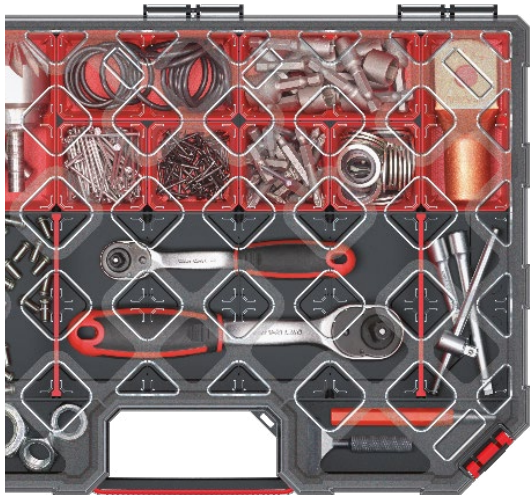

TAGER:

- Body made of a mixture of increased strength polymers
- Ergonomic handle
- Transparent polycarbonate lid
- Functional bins and partitions
- Durable fasteners
- Lots of storage space



Tager

Carbo Plus
organiser

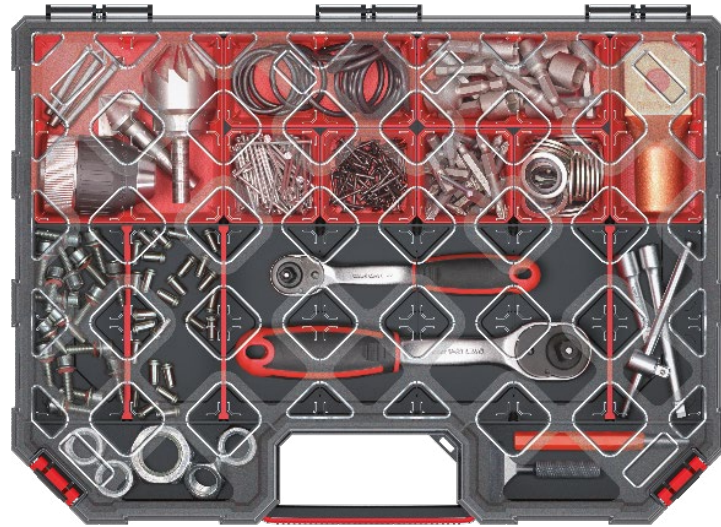

POLYCARBONATE LID

Tager

organiser



POLYPROPYLENE LID

You craft, we store.

Tager organiser

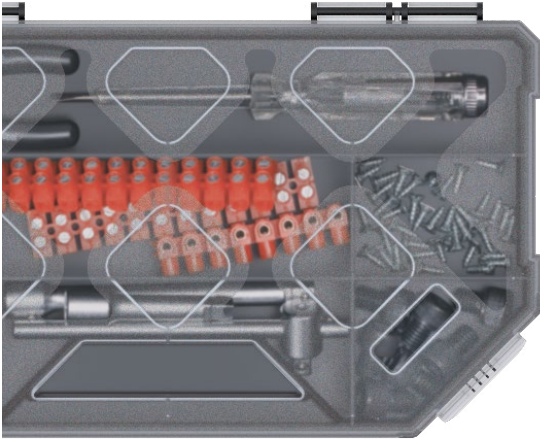









	TAGER organiser	TAGER organiser	TAGER organiser	TAGER organiser
	KTG20154	KTG25154	KTG30204	KTG30254
colour	S429	S429	S429	S429
mm	195 x 142 x 40	243 x 142 x 40	284 x 195 x 40	284 x 243 x 40
kg	-	-	-	-
pcs	10 / 80	10 / 60	10 / 40	10 / 20
pcs	1440	960	480	480
mm	~ 1920	~ 1900	~ 1700	~ 1900
i	polypropylene lid	polypropylene lid	polypropylene lid	polypropylene lid

TAGER:

- Body made of a mixture of increased strength polymers
- Ergonomic handle
- Transparent lid
- Durable fasteners

Tager organiser



	TAGER 30 organiser low	TAGER 30 organiser low	TAGER 40 organiser low	TAGER 60 organiser low
	KTG30206S	KTG30256S	KTG40306S	KTG60406S
 colour	S429	S429	S429	S429
 mm	284 x 195 x 60	284 x 243 x 60	390 x 284 x 60	577 x 390 x 60
 kg	-	-	-	-
 pcs	10 / -	10 / -	5 / -	5 / -
 pcs	480	360	240	120
 mm	~ 1880	~ 1900	~ 1920	~ 1850
	polypropylene lid, 4 x separators, two-component handle	polypropylene lid, 4 x separators, two-component handle	polypropylene lid, 12 x separators, two-component handle	polypropylene lid, 22 x separators, two-component handle

TAGER:

- Body made of a mixture of increased strength polymers
- Ergonomic handle
- Transparent lid
- Functional partitions
- Durable fasteners



You craft, we store.

Tager organiser



	TAGER 30 organiser high	TAGER 40 organiser high	TAGER 60 organiser high
	KTG302510S	KTG403010S	KTG604010S
colour	S429	S429	S429
mm	284 x 243 x 105	390 x 284 x 105	577 x 390 x 105
kg	-	-	-
pcs	5 / -	5 / -	5 / -
pcs	180	120	60
mm	~ 1680	~ 1700	~ 1770
	polypropylene lid, 4 x separators, two-component handle	polypropylene lid, 12 x separators, two-component handle	polypropylene lid, 22 x separators, two-component handle











TAGER:

- Body made of a mixture of increased strength polymers
- Ergonomic handle
- Transparent lid
- Functional partitions
- Durable fasteners



Tager organiser



	TAGER 30 organiser low	TAGER 30 organiser low	TAGER 40 organiser low	TAGER 60 organiser low
	KTG30206B	KTG30256B	KTG40306B	KTG60406B
 colour	S429	S429	S429	S429
 mm	284 x 195 x 60	284 x 243 x 60	390 x 284 x 60	577 x 390 x 60
 kg	-	-	-	-
 pcs	10 / -	10 / -	5 / -	5 / -
 pcs	480	360	240	120
 mm	~ 1880	~ 1900	~ 1920	~ 1850
	polypropylene lid, 9 x boxes, two-component handle	polypropylene lid, 7 x boxes, two-component handle	polypropylene lid, 12 x boxes, two-component handle	polypropylene lid, 27 x boxes, two-component handle

TAGER:

- Body made of a mixture of increased strength polymers
- Ergonomic handle
- Transparent lid
- Functional bins
- Durable fasteners



You craft, we store.

Tager organiser



	TAGER 30 organiser high	TAGER 40 organiser high	TAGER 60 organiser high
	KTG302510B	KTG403010B	KTG604010B
colour	S429	S429	S429
mm	284 x 243 x 105	390 x 284 x 105	577 x 390 x 105
kg	-	-	-
pcs	5 / -	5 / -	5 / -
pcs	180	120	60
mm	~ 1680	~ 1700	~ 1770
i	polypropylene lid, 7 x boxes, two-component handle	polypropylene lid, 12 x boxes, two-component handle	polypropylene lid, 27 x boxes, two-component handle

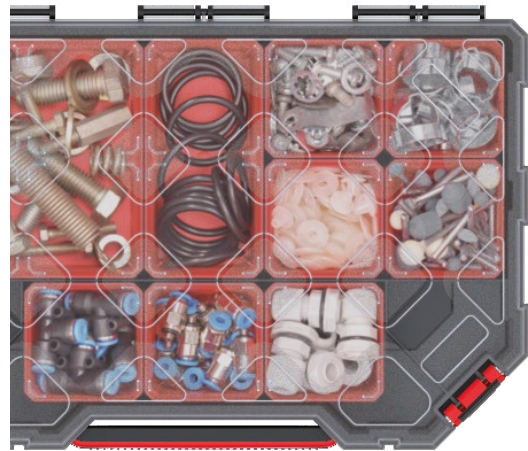

TAGER:

- Body made of a mixture of increased strength polymers
- Ergonomic handle
- Transparent lid
- Functional bins
- Durable fasteners



Tager Case organiser



	TAGER CASE organiser set	TAGER CASE organiser set	TAGER CASE organiser set	TAGER CASE organiser set
	KTC40306B	KTC40306S	KTC30256B	KTC30256S
colour	S411	S411	S411	S411
mm	415 x 290 x 295	415 x 290 x 295	415 x 290 x 295	415 x 290 x 295
kg	-	-	-	-
pcs	-	-	-	-
pcs	40	40	40	40
mm	~ 1850	~ 1850	~ 1850	~ 1850
	3 x organisers with 24 x boxes, wall mountable, stackable, ergonomic handle, portable	3 x organisers with 36 x separators, wall mountable, stackable, ergonomic handle, portable	5 x organisers with 35 x boxes, wall mountable, stackable, ergonomic handle, portable	5 x organisers with 20 x separators, wall mountable, stackable, ergonomic handle, portable

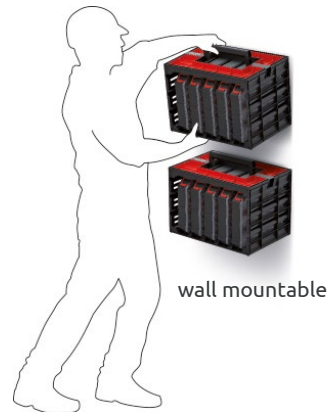
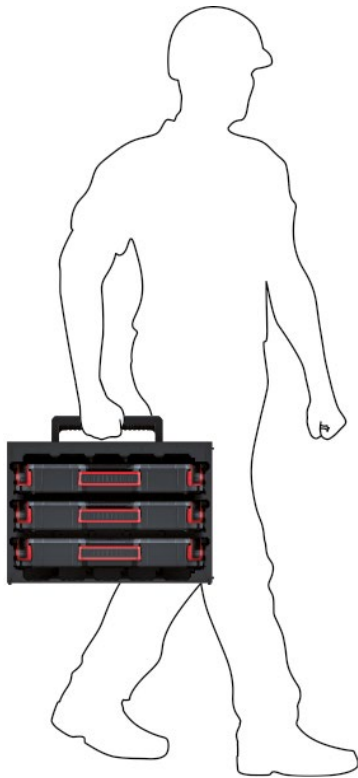

Multicase Cargo organiser

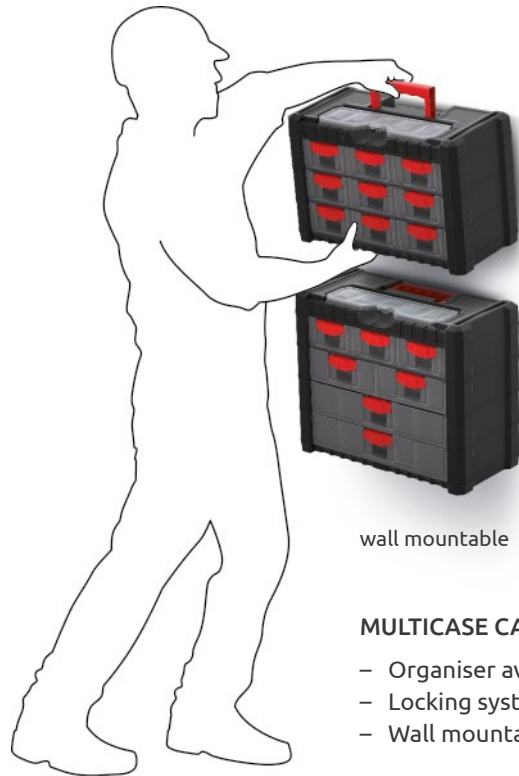

wall mountable

MULTICASE CARGO:

- Organiser available in 4 sizes
- Locking system to prevent drawers from falling out
- Wall mountable and stackable











	MULTICASE CARGO organiser	MULTICASE CARGO organiser	MULTICASE CARGO organiser	MULTICASE CARGO organiser
	KMC301	KMC303	KMC401	KMC501
	S411	S411	S411	S411
	mm	400 x 200 x 260	400 x 200 x 260	400 x 200 x 326
	kg	-	-	-
	pcs	-	-	-
	pcs	81	81	60
	mm	~ 1910	~ 1910	~ 1780
		wall mountable and stackable, 6 x transparent drawers, comfortable handle	wall mountable and stackable, 9 x transparent drawers, comfortable handle	wall mountable and stackable, 7 x transparent drawers, comfortable handle



Nor organiser



	NOR 20 organiser	NOR 30 organiser	NOR 40 organiser	NOR 50 organiser
	KNO20154	KNO30204	KNO40307	KNO50407
 colour	S429	S429	S429	S429
 mm	195 x 155 x 35	290 x 195 x 35	390 x 290 x 65	490 x 390 x 65
 kg	-	-	-	-
 pcs	- / 48	15 / 60	10 / -	6 / -
 pcs	1152	720	200	108
 mm	~ 1800	~ 1700	~ 1800	~ 1650
	organisers for small parts, 6 x removable separators, transparent lid	organisers for small parts, 15 x removable separators, transparent lid	organisers for small parts, 10 x removable separators, transparent lid	organisers for small parts, 12 x removable separators, transparent lid

NOR:







- Designed to store and organise a large number of small items in one place
- Available in 4 sizes
- Removable separators which help to personalise the storage space
- Transparent lids made of impact-resistant polymer blend



Nor Duo

organiser



	NOR organiser set	NOR organiser set
	KNOS403015	KNOS504015
colour	S429	S429
 mm	390 x 290 x 130	490 x 390 x 130
 kg	-	-
 pcs	5 / -	3 / -
 pcs	100	54
 mm	~ 1800	~ 1650
	double organisers for small parts, 20 x removable separators, transparent lid	double organisers for small parts, 24 x removable separators, transparent lid







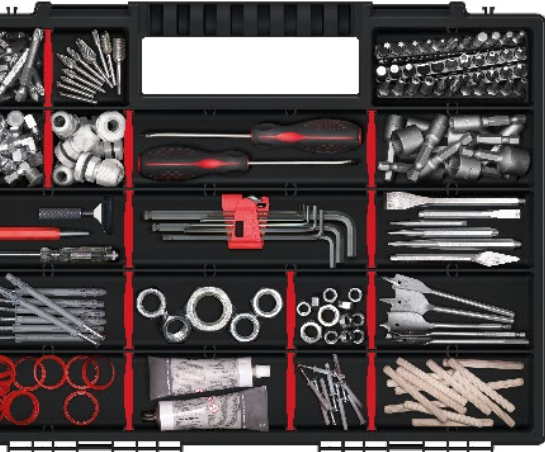

NOR DUO:

- Designed to store and double organise a large number of small items in one place
- Available in 2 sizes
- Removable separators which help to personalise the storage space
- Transparent lids made of impact-resistant polymer blend



Nors organiser



	NORS 30 organiser	NORS 35 organiser	NORS 40 organiser
	KNO30205S	KNO35255S	KNO40305S
 colour	S429	S429	S429
 mm	287 x 186 x 50	344 x 249 x 50	399 x 303 x 50
 kg	-	-	-
 pcs	10 / 40	10 / -	10 / -
 pcs	480	340	240
 mm	~ 1700	~ 1900	~ 1750
	organisers for small parts, 8 x removable separators, transparent lid	organisers for small parts, 15 x removable separators, transparent lid	organisers for small parts, 26 x removable separators, transparent lid

NORS:

- Designed to store and organise a large number of small items in one place
- Available in 3 sizes
- Removable separators which help to personalise the storage space
- Transparent lids made of impact-resistant polymer blend



You craft, we store.

Nors Duo organiser



	NORS organiser set	NORS organiser set	NORS organiser set
	KNOS302010S	KNOS352510S	KNOS403010S
colour	S429	S429	S429
mm	287 x 186 x 100	344 x 249 x 100	399 x 303 x 100
kg	-	-	-
pcs	5 / 20	5 / -	5 / -
pcs	240	170	120
mm	~ 1700	~ 1900	~ 1750
	double organisers for small parts, 16 x removable separators, transparent lid	double organisers for small parts, 30 x removable separators, transparent lid	double organisers for small parts, 52 x removable separators, transparent lid









NORS DUO:

- Designed to store and double organise a large number of small items in one place
- Available in 3 sizes
- Removable separators which help to personalise the storage space
- Transparent lids made of impact-resistant polymer blend



Norb organiser



	NORB 30 organiser	NORB 35 organiser	NORB 40 organiser
	KNO30205B	KNO35255B	KNO40305B
 colour	S429	S429	S429
 mm	287 x 186 x 50	344 x 249 x 50	399 x 303 x 50
 kg	-	-	-
 pcs	10 / 40	10 / -	10 / -
 pcs	480	340	240
 mm	~ 1700	~ 1900	~ 1750
	organisers for small parts, 6 x removable boxes, transparent lid	organisers for small parts, 11 x removable boxes, transparent lid	organisers for small parts, 21 x removable boxes, transparent lid

NORB:

- Designed to store and organise a large number of small items in one place
- Available in 3 sizes,
- Removable separators which help to personalise the storage space
- Transparent lids made of impact-resistant polymer blend



You craft, we store.

Norb Duo

organiser



	NORB organiser set	NORB organiser set	NORB organiser set
	KNOS302010B	KNOS352510B	KNOS403010B
colour	S429	S429	S429
mm	287 x 186 x 100	344 x 249 x 100	399 x 303 x 100
kg	-	-	-
pcs	5 / 20	5 / -	5 / -
pcs	240	170	120
mm	~ 1700	~ 1900	~ 1750
	double organisers for small parts, 12 x removable boxes, transparent lid	double organisers for small parts, 22 x removable boxes, transparent lid	double organisers for small parts, 42 x removable boxes, transparent lid

NORB DUO:

- Designed to store and double organise a large number of small items in one place
- Available in 3 sizes
- Removable separators which help to personalise the storage space
- Transparent lids made of impact-resistant polymer blend



MSX Box

organiser











MSX box



MSX box



MSX box

	KMXB3015	KMXB3015S	KMXBB3015S
 colour	S429	S429	S411
 mm	285 x 158 x 57	285 x 158 x 57	285 x 158 x 57
 kg	-	-	-
 pcs	- / 32	- / 32	- / 32
 pcs	576	576	576
 mm	~ 1920	~ 1920	~ 1920
	organisers for small parts, transparent lid	organisers for small parts, 3 x separators, transparent lid	organisers for small parts, 3 x separators, black lid

MSX BOX:

- Transparent or black lids made of impact-resistant polymer blend
- Removable separators which help to personalise the storage space
- Fit the MSX, CMX, X BLOCK BRIDGE and C BLOCK BRIDGE organisers



You craft, we store.

SQR Box organiser



	SQR box	SQR box	SQR box	new SQR box	new SQR box
	KSQ15154	KSQ15155	KSQ20154	KSQ30204	KSQ35254
	S429	S429	S429	S429	S429
mm	156 x 140 x 35	156 x 140 x 50	193 x 147 x 35	275 x 186 x 41	355 x 230 x 41
kg	-	-	-	-	-
pcs	12 / 44	8 / 96	6 / 48	i / i	i / i
pcs	1728	1152	1536	i	i
mm	~ 1700	~ 1700	~ 1700	i	i
	transparent organisers for small parts, fixed separators	transparent organisers for small parts, fixed separators	transparent organisers for small parts, fixed separators	transparent organisers for small parts, 8 x removable separators	transparent organisers for small parts, 10 x removable separators















QR BOX:

- Transparent organisers for small parts
- Available in 5 sizes
- Stackable



Nort & Knox organiser



	KNOX organiser	KNOX organiser	NORT organiser	NORT organiser	NORT organiser	NORT organiser
	KKNO2010	KKNO2015	KNO20154T	KNO30204T	KNO35255T	KNO40307T
 colour						
 mm	186 x 90 x 35	200 x 160 x 35	195 x 155 x 35	290 x 195 x 35	344 x 249 x 50	390 x 290 x 65
 kg	-	-	-	-	-	-
 pcs	- / 120	- / 60	- / 48	15 / 60	10 / -	10 / -
 pcs	2160	1080	1152	720	340	200
 mm	~ 1700	~ 1700	~ 1800	~ 1700	~ 1900	~ 1800
	transparent organisers for small parts, fixed separators		organisers for small parts, 6 x removable separators, transparent	organisers for small parts, 15 x removable separators, transparent	organisers for small parts, 15 x removable separators, transparent	organisers for small parts, 10 x removable separators, transparent

NORT:

- Designed to store and organise a large number of small items in one place
- Available in 4 sizes,
- Removable separators which help to personalise the storage space
- Transparent organisers



Nun organiser



	NUN organiser	NUN organiser	NUN organiser	NUN organiser	NUN organiser
	KNU20	KNU25	KNU30	KNU36	KNU40
colour	S429	S429	S429	S429	S429
mm	198 x 117 x 45	245 x 150 x 85	295 x 195 x 85	359 x 238 x 85	400 x 298 x 85
kg	-	-	-	-	-
pcs	- / 45	- / 38	- / 24	- / 16	- / 12
	1080	456	288	160	144
mm	~ 1900	~ 1700	~ 1700	~ 1770	~ 1830
	transparent organiser, fixed separators, hanging loop	transparent organiser, fixed separators, comfortable handle	transparent organiser, fixed separators, comfortable handle	transparent organiser, removable separators, comfortable handle	transparent organiser, removable separators, comfortable handle

NUN:

- Transparent organisers to store and organize small items
- Available in 5 sizes
- Comfortable handle



Battery Box

organiser

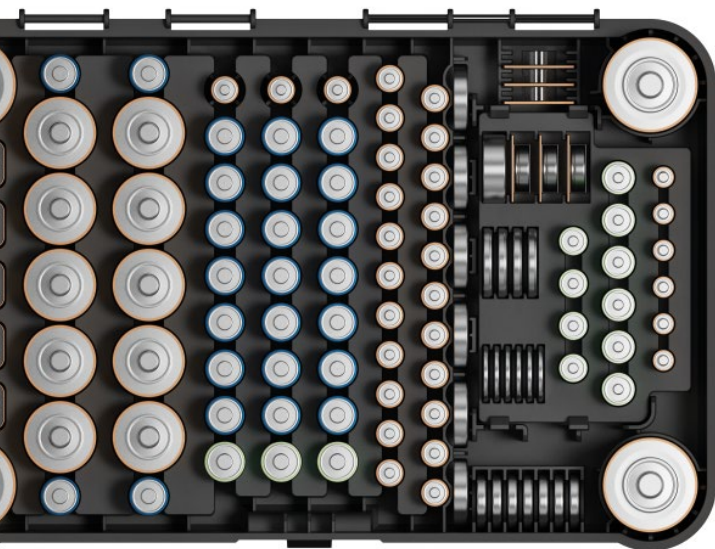





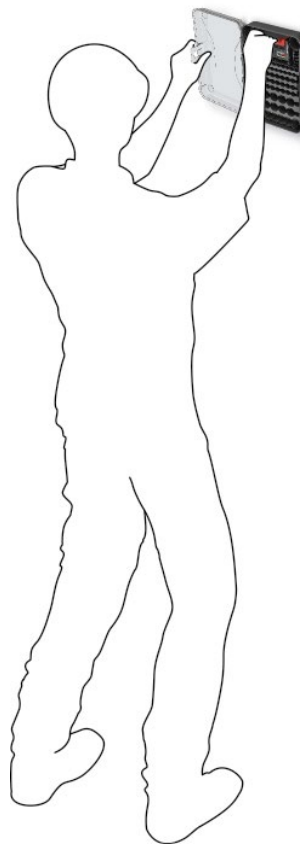

BATTERY BOX:

- Slots for battery storing
- Optional with battery tester or additional slots for tiny batteries
- Body made of a mixture of increased strength polymers
- Transparent polycarbonate lid
- Wall mountable

wall mountable



BATTERY BOX organiser

	KBB03
colour	CG6U
 mm	295 x 195 x 70
 kg	-
 pcs	8 / 32
 pcs	384
 mm	~ 1830
	polycarbonate cover, 115 slots for batteries



You craft, we store.

Battery Box

with tester
organiser

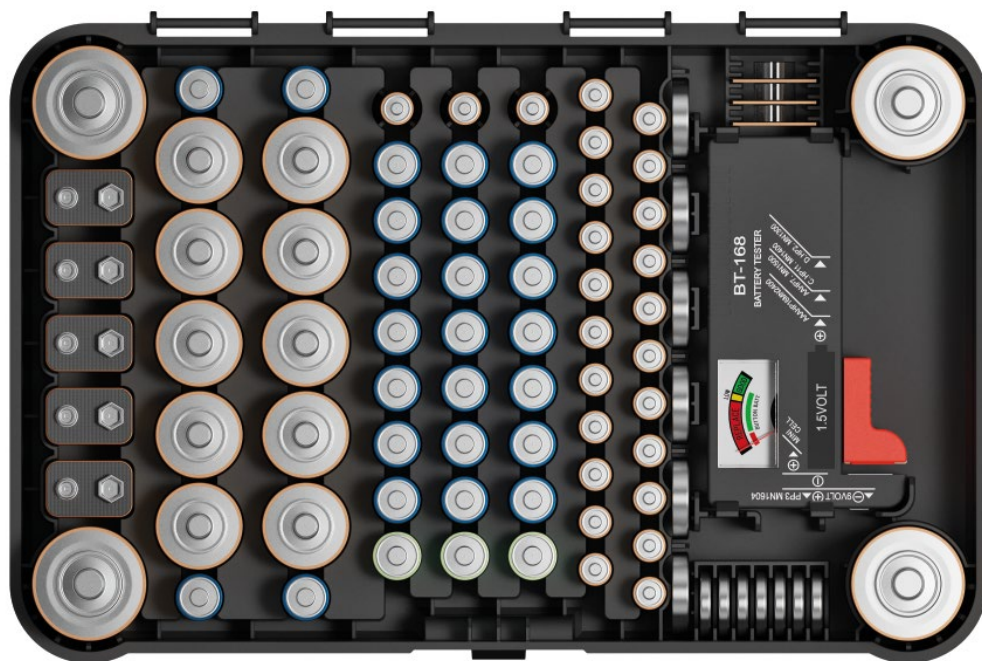









BATTERY BOX WITH TESTER organiser	
	KBBT
colour	CG6U
	mm 295 x 195 x 70
	kg -
	pcs 8 / 32
	pcs 384
	mm ~ 1830
	polycarbonate cover, 85 slots for batteries, battery tester inside



Truck Max storage bin



	TRUCK MAX storage bin	TRUCK MAX storage bin	TRUCK MAX storage bin
	KTRM4030	KTRM4040	KTRM6040
 colour	S411	S411	S411
 mm	396 x 290 x 280	396 x 380 x 282	580 x 380 x 342
 kg	-	-	-
 pcs	5 / -	5 / -	3 / -
 pcs	160	120	81
 mm	~ 1700	~ 1660	~ 1860
			

TRUCK MAX:

- Durable polymer blend body
- Stackable
- Wall mountable
- Handles for easy carrying



You craft, we store.

Truck Max Plus storage bin

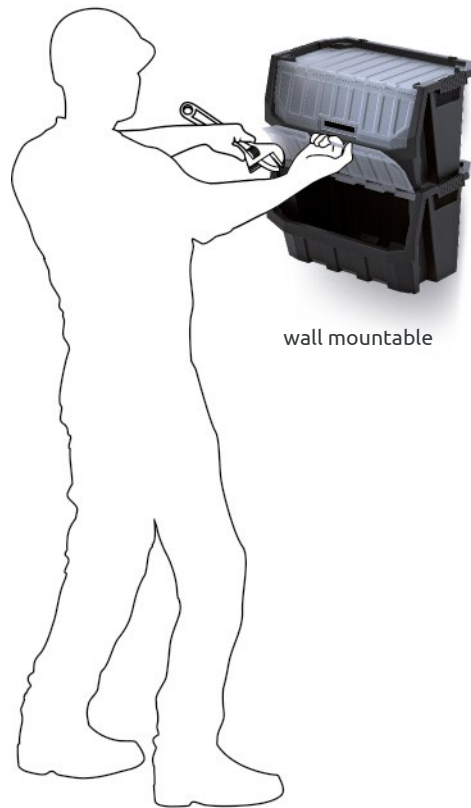

	TRUCK MAX PLUS storage bin	TRUCK MAX PLUS storage bin	TRUCK MAX PLUS storage bin
	KTRM4030F	KTRM4040F	KTRM6040F
colour	S411	S411	S411
mm	396 x 290 x 280	396 x 380 x 282	580 x 380 x 342
kg	-	-	-
pcs	-/5	-/5	-/5
pcs	90	90	60
mm	~ 1700	~ 1700	~ 1920

TRUCK MAX:

- Durable polymer blend body
- Protective transparent cover
- Stackable
- Wall mountable
- Handles for easy carrying



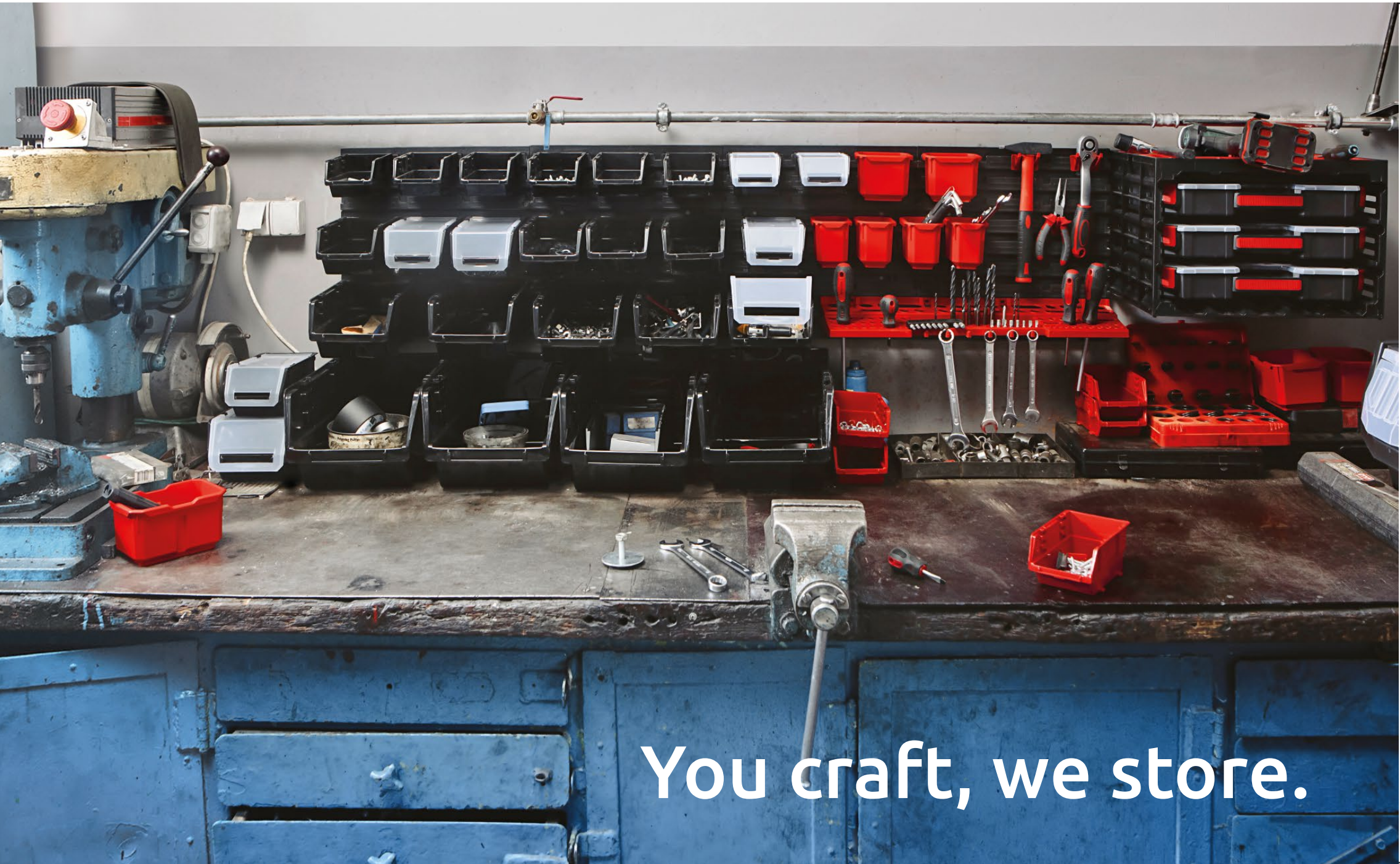

You craft, we store.

You craft, we store.

Click Box storage bin



		CLICK BOX storage bin				
		KCB16	KCB23	KCB30	KCB36	KCB45
colour		S411	S411	S411	S411	S411
← ↗ ↑	mm	162 x 108 x 75	225 x 140 x 95	300 x 200 x 140	360 x 240 x 160	450 x 300 x 190
⚖	kg	-	-	-	-	-
📦 / 📦	pcs	6 / 72	6 / -	6 / -	6 / -	4 / -
🏠	pcs	1296	504	192	90	56
📏	mm	~ 1700	~ 1770	~ 1770	~ 1700	~ 1930
i						

CLIK BOX:





















- HI-TECH material POLYSTYRENE
- Durable body
- High load resistance
- Interconnectable
- Stackable
- Flat inside
- Possibility of building sets



Truck storage bin



TRUCK storage bin

	KTR12	KTR16	KTR20	KTR23	KTR30	KTR40	KTR50
 colour	 	 	 	 	 	 	 
 mm	115 x 80 x 60	155 x 100 x 70	195 x 120 x 90	230 x 160 x 120	290 x 200 x 150	390 x 240 x 180	490 x 298 x 210
 kg	-	-	-	-	-	-	-
 pcs	36 / 900	33 / 462	28 / 252	16 / 128	15 / -	10 / -	6 / -
 pcs	10800	5544	3024	1536	1080	560	216
 mm	~ 1950	~ 1950	~ 1950	~ 1830	~ 1950	~ 1950	~ 1650
							

TRUCK:

- Body made of a durable polymer blend
- Can be wall mountable with a dedicated hanging bar or panel
- Stackable
- Variety of sizes, dedicated to multiple tools and needs

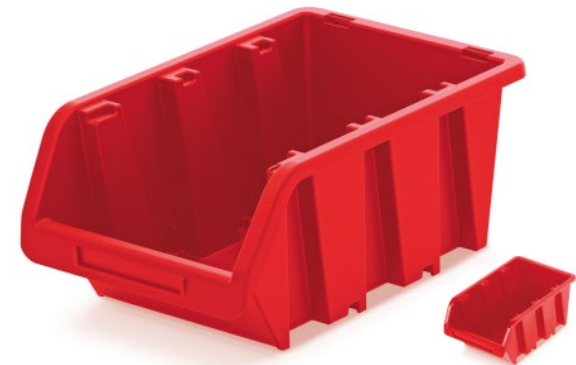

You craft, we store.

Truck Plus storage bin

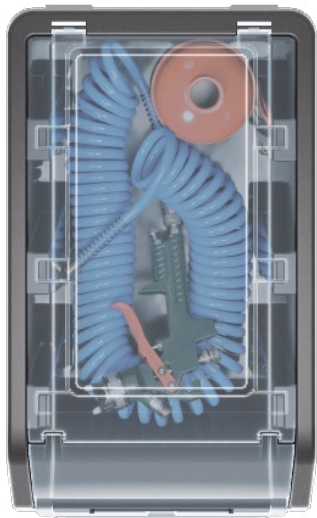

		TRUCK PLUS storage bin			
		KTR16F	KTR20F	KTR23F	KTR50F
	colour	S411 3020	S411 3020	S411 3020	S411 3020
	mm	155 x 100 x 70	195 x 120 x 90	230 x 160 x 120	490 x 298 x 210
	kg	-	-	-	-
	pcs	10 / 40	10 / 40	10 / 40	-
	pcs	2400	1600	800	51
	mm	~ 1770	~ 1930	~ 1770	~ 1830

TRUCK PLUS:

- Body made of a durable polymer blend
- Can be wall mountable with a dedicated hanging bar or panel
- Stackable
- Transparent lockable lid



Bineer Short storage bin



		BINEER SHORT storage bin					
		KBIS10	KBIS12	KBIS15	KBIS20	KBIS22	KBIS28
colour		3020 S411	3020 S411	3020 S411	3020 S411	3020 S411	3020 S411
↔ ↕	mm	92 x 77 x 60	118 x 98 x 70	144 x 118 x 84	187 x 158 x 114	214 x 198 x 133	272 x 238 x 160
⚙️	kg	-	-	-	-	-	-
📦 / 📦	pcs	28 / 728	24 / 384	16 / 288	14 / 126	14 / -	12 / -
🏠	pcs	13104	6912	3456	1512	1260	672
📏	mm	~ 1700	~ 1700	~ 1830	~ 1700	~ 1930	~ 1810
i		economic packaging, stackable, moulded in card holder, hooks for hanging, edge design to allow vertical stacking					

BINEER SHORT:

- Body made of a durable polymer blend
- Can be wall mountable with a dedicated hanging bar or panel
- Stackable
- Available in 6 sizes

Bineer Short set storage bin



		BINEER SHORT SET storage bin					
		KBISS10	KBISS12	KBISS15	KBISS20	KBISS22	KBISS28
colour		3020 S411	3020 S411	3020 S411	3020 S411	3020 S411	3020 S411
↔ ↑	mm	234 x 77 x 92	180 x 98 x 118	206 x 118 x 144	288 x 158 x 187	214 x 198 x 238	272 x 238 x 236
⚖	kg	-	-	-	-	-	-
📦 / 📦	pcs	- / 32	- / 24	- / 14	- / 12	5 / -	6 / -
🏠	pcs	768	576	336	144	225	168
📏	mm	~ 1900	~ 1900	~ 1900	~ 1950	~ 1910	~ 1810
📄	economic packaging, stackable, moulded in card holder, connector for bin joining sizes 10 - 12 -15, hooks for hanging, edge design to allow vertical stacking						

BINEER SHORT SET:







- Body made of a durable polymer blend
- Can be wall-mounted with a dedicated hanging bar or panel
- Stackable in 2 directions: vertically and horizontally



Bineer Long storage bin



BINEER LONG storage bin

	KBIL12	KBIL16	KBIL20	KBIL25	KBIL30
	KBIL12	KBIL16	KBIL20	KBIL25	KBIL30
colour	3020 5411	3020 5411	3020 5411	3020 5411	3020 5411
 mm	120 x 77 x 60	160 x 98 x 70	198 x 118 x 84	249 x 158 x 114	295 x 198 x 133
 kg	-	-	-	-	-
 pcs	24 / 480	24 / 288	16 / 224	12 / 84	14 / -
 pcs	8640	5184	2688	1008	1008
 mm	~ 1700	~ 1700	~ 1830	~ 1700	~ 1930
	long storage bins, economic packaging, stackable, moulded in card holder, hooks for hanging, edge design to allow vertical stacking				

BINEER LONG:

- Body made of a durable polymer blend
- Can be wall mountable with a dedicated hanging bar or panel
- Stackable
- Available in 5 sizes

Bineer Long set storage bin



		BINEER LONG SET storage bin				
		KBILS12	KBILS16	KBILS20	KBILS25	KBILS30
colour		3020 S411	3020 S411	3020 S411	3020 S411	3020 S411
↔ ↕	mm	190 x 77 x 120	160 x 98 x 160	198 x 118 x 155	249 x 158 x 213	295 x 198 x 195
⚙	kg	-	-	-	-	-
📦 / 📦	pcs	- / 28	- / 24	- / 16	- / 12	7 / -
🏠	pcs	672	432	288	144	252
📏	mm	~ 1900	~ 1700	~ 1700	~ 1950	~ 1910
📄	economic packaging, stackable, moulded in card holder, connector for bin joining sizes 12 - 16 - 20, hooks for hanging, edge design to allow vertical stacking					

BINEER LONG SET:

- Body made of a durable polymer blend
- Can be wall mountable with a dedicated hanging bar or panel
- Stackable in 2 directions: vertically and horizontally



Tager Box set



new

TAGER BOX SET storage bin











new

TAGER BOX SET storage bin



new

TAGER BOX SET storage bin

	KTBM55	KTBM115	KTBM1111
	3020 10 pcs	3020 10 pcs	3020 10 pcs
 mm	50 x 50 x 185	105 x 50 x 270	105 x 105 x 270
 kg	-	-	-
 pcs	1 / 98	1 / 56	1 / 24
 pcs	2940	896	384
 mm	~ 1870	~ 1870	~ 1870
	<p>Set of 10 pieces of 50 x 50 x 50 mm boxes</p> <ul style="list-style-type: none"> - Made of a resistant polymer blend - Available in red - Compatibility with series: TAGER, TAGER CASE KTC40306B, KTC30256B 	<p>Set of 10 pieces of 105 x 50 x 50 mm boxes</p> <ul style="list-style-type: none"> - Made of a resistant polymer blend - Available in red - Compatibility with series: TAGER, TAGER CASE KTC40306B, KTC30256B 	<p>Set of 10 pieces of 105 x 105 x 50 mm boxes</p> <ul style="list-style-type: none"> - Made of a resistant polymer blend - Available in red - Compatibility with series: TAGER, TAGER CASE KTC40306B, KTC30256B

TAGER BOX:

- Compatible with TAGER series organisers
- The sets contain 10 boxes per package.
- Available in 6 sizes



You craft, we store.

Tager Box set



new

TAGER BOX SET storage bin



new

TAGER BOX SET storage bin



new

TAGER BOX SET storage bin



	KTBL55	KTBL115	KTBL1111
colour	3020 10 pcs	3020 10 pcs	3020 10 pcs
mm	50 x 50 x 340	105 x 50 x 370	105 x 105 x 370
kg	-	-	-
pcs	1 / 80	1 / 40	1 / 20
pcs	1280	640	320
mm	~ 1870	~ 1870	~ 1870
	<p>Set of 10 pieces of 50 x 50 x 97 mm boxes</p> <ul style="list-style-type: none"> - Made of a resistant polymer blend - Available in red - Compatibility with series: TAGER (TALL VERSION) 	<p>Set of 10 pieces of 105 x 50 x 97 mm boxes</p> <ul style="list-style-type: none"> - Made of a resistant polymer blend - Available in red - Compatibility with series: TAGER (TALL VERSION) 	<p>- Set of 10 pieces of 105 x 105 x 97 mm boxes</p> <ul style="list-style-type: none"> - Made of a resistant polymer blend - Available in red - Compatibility with series: TAGER (TALL VERSION)



Titan Box set



		TITAN BOX SET storage bin					
		KTIS11		KTIS16			
	colour	3020	S411 mix	6 pcs	3020	S411 mix	4 pcs
	mm	110 x 75 x 263		156 x 110 x 195			
	kg	-		-			
	pcs	-/ 36		-/ 24			
	pcs	648		432			
	mm	~ 1760		~ 1950			
	adjusted to hang on the toolboard, compatible with Titan organiser						

TITAN BOX:

- Made of resistant polymer blend
- A kit for arranging the workshop or storage space in any configuration
- Can be wall-mounted with a dedicated hanging bar or panel



X Block Box set



		X BLOCK BOX SET storage bin					
		KXBS148		KXBS1614			
	colour	3020	S411 mix	6 pcs	3020	S411 mix	4 pcs
	mm	140 x 75 x 280		157 x 140 x 210			
	kg	-		-			
	pcs	-/ 24		-/ 16			
	pcs	432		288			
	mm	~ 1830		~ 1830			
	adjusted to hang on the toolboard, compatible with X Block, X Block Bridge, C Block, C Block Bridge, MSX, CMX						



Unite Box set



	UNITE BOX SET storage bin		
	KBS55	KBS115	KBS1111
colour	3020 5411 7 pcs	3020 5411 5 pcs	3020 5411 4 pcs
mm	55 x 55 x 165	110 x 55 x 132	110 x 110 x 112
kg	-	-	-
pcs	8 / 128	6 / 72	4 / 80
pcs	3072	1728	1280
mm	~ 1870	~ 1870	~ 1870
	compatyblie with X Block Log, X Block Alu Log, C Block Alu Log, S Block Alu Log, Heavy, Optima, Evo, Smart, Nor, Nor Duo, Norb, Norb Duo, standard packing 1 color per set		

UNITE BOX SET:

- Made of resistant polymer blend
- A set of bins for storing small items
- Designed for Heavy, Optima, Evo, Smart, Nor







Product images are for illustrative purposes only and may differ from the actual product.



Settruck

set of storage bins



	KST16
	S411 3020 mix
 mm	580 x 235 x 130
 kg	-
 pcs	-
 pcs	78
 mm	~ 1850



stackable storage bins,
16 Bins + 5 Hanging Bar



KHB40
5 pcs



KTR12
4 pcs



KTR16
4 pcs



KTR20
4 pcs



KTR23
4 pcs

SETTRUCK:

- Made of resistant polymer blend
- A kit for arranging the workshop or storage space in any configuration



Multiholder hanger

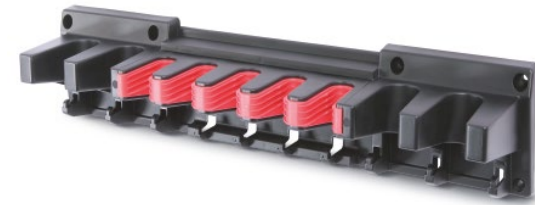

	KMH30	KMH60
colour	S411	S411
mm	310 x 98 x 70	597 x 128 x 118
kg	~ 7	~ 15
pcs	5 / 40	4 / 20
pcs	720	200
mm	~ 1820	~ 1770
	universal tool holder	universal tool holder

MULTIHOLDER:

- A holder for workshop or garden hand tools
- Made of polymer blends with increased strength
- A flexible insert guarantees that tools of various sizes are kept in place

Product images are for illustrative purposes only and may differ from the actual product.



Orderline set



ETBNN400 2 pcs



KTR16 16 pcs
KTR20 12 pcs



ETBNN400 2 pcs

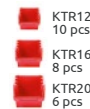

KTR12 10 pcs
KTR16 8 pcs
KTR20 6 pcs



ETBNN400 2 pcs

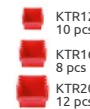

KTR12 10 pcs
KTR16 8 pcs
KTR20 12 pcs



ETBNN400 2 pcs



KB520 2 pcs

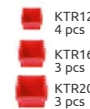

KTR12 4 pcs
KTR16 3 pcs
KTR20 3 pcs

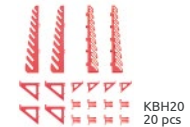

KBH20 20 pcs

	KOR1	KOR2	KOR3	KOR4
colour	S411	S411	S411	S411
mm	400 x 165 x 400	400 x 165 x 400	400 x 165 x 400	400 x 165 x 400
kg	-	-	-	-
pcs	-/1	-/1	-/1	-/1
pcs	60	60	60	60
mm	~ 1800	~ 1800	~ 1800	~ 1800
	2 x toolboard + bins	2 x toolboard + bins	2 x toolboard + bins	2 x toolboard + bins, tool hangers



ORDRLINE:

- The panel is made of durable polymer mix
- Holes for mounting pins
- Interconnectable
- Compatible with Truck, Binner, X Block and Titan Bins

Orderline set









ETBNN400 1 pc

-  KTR16 3 pcs
-  KTR20 4 pcs



ETBNN400 2 pcs

-  EPH1 14 pcs
-  EPH2 6 pcs

	KOR5	KOR6
colour	S411	S411
 mm	400 x 110 x 400	400 x 165 x 400
 kg	-	-
 pcs	- / 1	- / 1
 pcs	90	60
 mm	~ 1870	~ 1800
	board + bins	2 x toolboard + Titan boxes







ORDERLINE:

- Panel with workshop containers
- Made of resistant polymer blend
- A kit for arranging the workshop or storage space in any configuration



Bineer Board



	HANGING BAR		BINEER BOARD set		BINEER BOARD set		BINEER BOARD	
	KHB40	50 pcs	KBBS4013	2 pcs	KBBS4040	2 pcs	KBB6040	1 pc
colour	S411		S411		S411		S411	
 mm	386 x 8 x 43		386 x 18 x 130		386 x 18 x 390		576 x 18 x 390	
 kg	-		-		-		-	
 pcs	-/ 50		-/ 42		-/ 13		-/ 30	
 pcs	8500		756		234		360	
 mm	~ 1480		~ 1700		~ 1700		~ 1830	
	interconnectable hanging bar		interconnectable, tool board		interconnectable, tool board		interconnectable, tool board	

BINEER BOARD:

- The panel is made of durable polymer mix
- Holes for mounting pins
- Interconnectable
- Compatible with Truck, Binner, X Block and Titan Bins



Bineer accessories

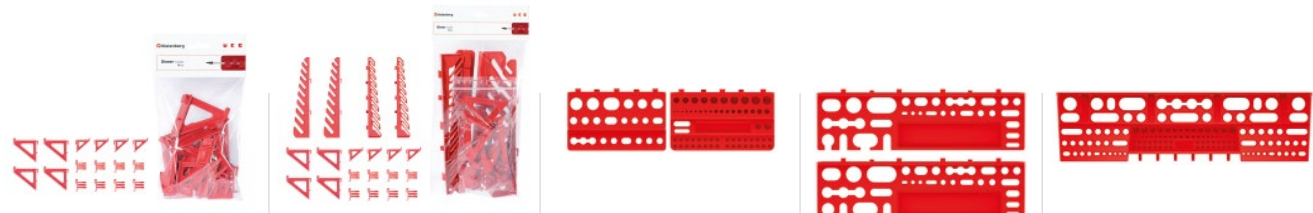

	BINEER HOOKS set	BINEER HOOKS set	BINEER SHELVES set	BINEER SHELVES set	BINEER SHELF
	KBH16 16 pcs	KBH20 20 pcs	KBS20 2 pcs	KBSS40 2 pcs	KBS60 1 pc
colour	3020	3020	3020	3020	3020
mm	130 x 130	200 x 320	190 x 111 x 55	384 x 111 x 50	580 x 158 x 67
kg	-	-	-	-	-
pcs	26 / 104	10 / 20	10 / 100	8 / -	8 / 32
pcs	2496	640	1200	576	384
mm	~1870	~ 1700	~ 1830	~ 1830	~ 1830
	tool hangers	tool hangers	tool shelf	tool shelf	tool shelf



BINEER HOOKS:

- Made of resistant polymer blend
- Possibility of arranging the workshop tool panel in any configuration

BINEER SHELVES:

- Made of resistant polymer blend
- A set for arranging the workshop tool panel in any configuration

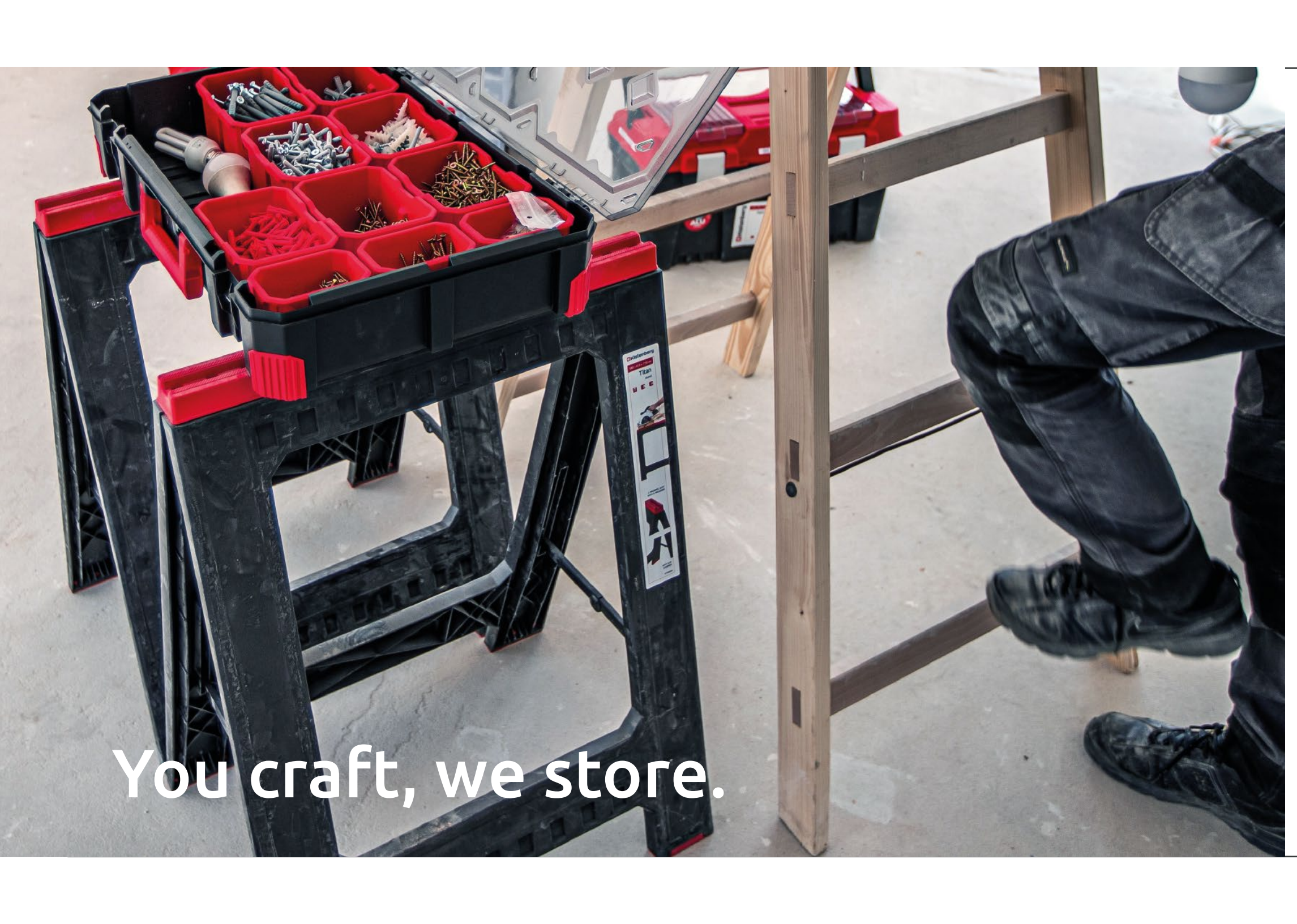

You craft, we store.

You craft, we store.

Titan Stand

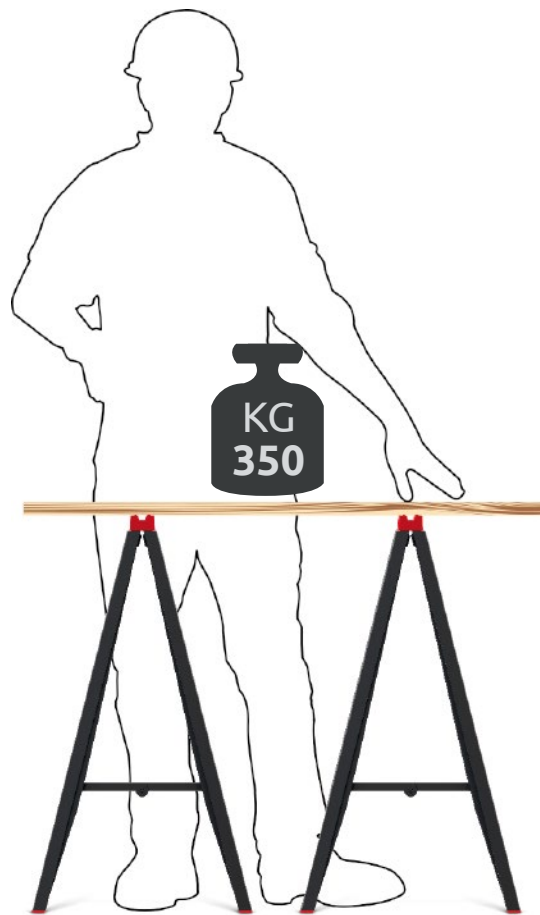

a pruning slot with a measure

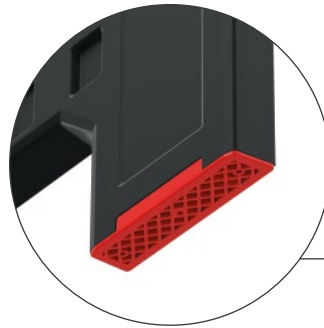







anti-slip elastomer feet



TITAN STAND:

- Versatile construction and workshop stand
- Very durable design
- Easy to store and unfold quickly
- Top edge with a handy ruler specially shaped to make easier cutting pipes and bars
- The stands provided with flexible anti-slip feet to prevent vibrations and movements during use
- Load carrying capacity of up to 350 kg per set of 2 pcs

	TITAN stand
	KTIS8060
colour	S411
 mm	580 x 415 x 770
 kg	~ 175
 pcs	- / 6
 pcs	60
 mm	~ 1760
	



You craft, we store.

Tech Stand

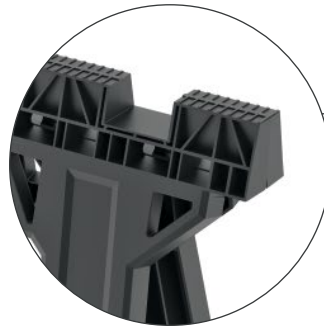
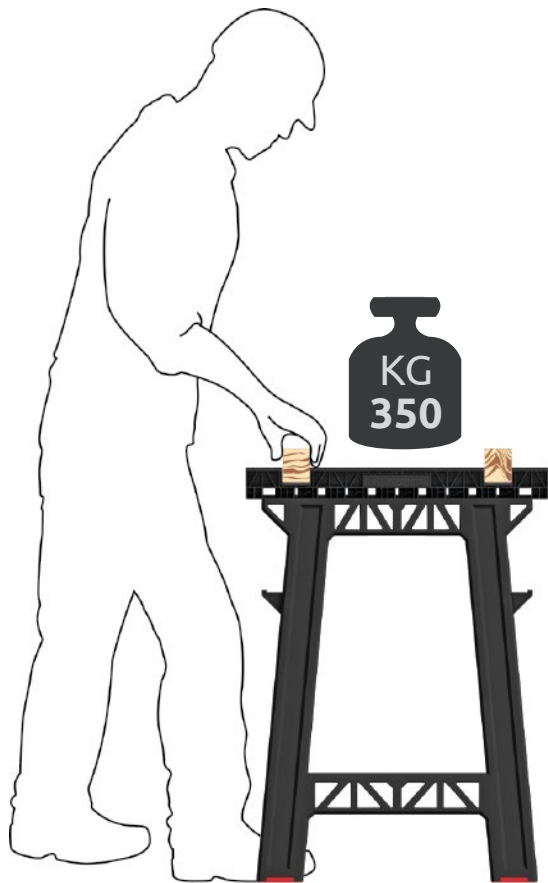

special grooves for cutting materials

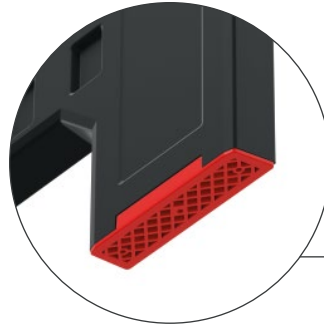

anti-slip elastomer feet



TECH STAND:

- Working height: 77cm
- Anti-slip elastomer feet
- Two stands providing a load capacity of up to 350 kg
- 4 hangers
- Special grooves for cutting materials with a width of 52 mm / 2"
- Space for installing carpentry clamps
- Work shelf for lightweight tools, dimensions: 32x25 cm
- Folded dimensions of the horse: 58x5x79.5 cm (length x width x height)
- Weight: 2.32 kg

new

TECH stand

	KTS8060
colour	S411
	mm 580 x 415 x 770
	kg ~ 175
	pcs - / 6
	pcs 60
	mm ~ 1760



You craft, we store.

Titan Ladder

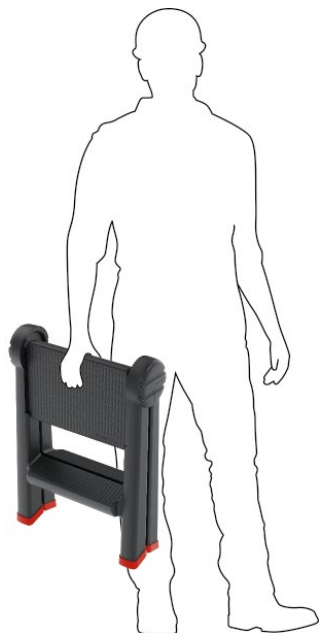

TITAN LADDER:

- EN-14183 : 2003 certificate
- Load-bearing capacity up to 150 kg
- Double-sided folding ladder
- Body made of reinforced structure
- Two stable, grooved steps and a working platform
- Non-slip elastomer feet
- Comfortable handles
- Multifunctional
- Special folded design for storage in limited space areas
- Made of high-quality plastic

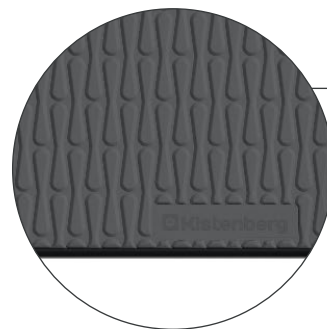

Double -Sided access steps

Anti slip stopper



correct use



incorrect use

Doubled-Sided access steps



	TITAN ladder	
	KLD4565	
colour	S411	
	mm	470 x 435 x 630
	kg	~ 150
	pcs	-/-
	pcs	32
	mm	~ 1900
	Double - Sided Access Step Ladder - with steps on both sides for comfortable use	



Doubled-Sided access steps.

Tittan Ladder



One side access steps.

Uni Ladder

Uni Ladder

UNI LADDER:

- EN-14183 : 2003 certificate
- Load-bearing capacity up to 150 kg
- One side folding ladder
- Lightweight and durable compact design
- Non-slip elastomer feet
- Multifunctional
- Special folded design for storage in limited space areas
- Made of high-quality plastic



One side access steps

Anti slip stopper



new

UNI ladder

	KUL4560
colour	S411
	mm 470 x 435 x 600
	kg ~ 150
	pcs - / 6
	pcs 37
	mm ~ 1870



correct use

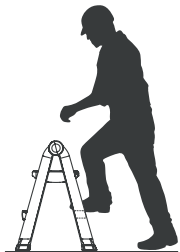

incorrect use



You craft, we store.









You craft, we store.

Cart T folding trolley

CART T:

- Reinforced wall structure
- Easy assembly
- Ergonomic telescopic handle
- Maximum load capacity up to 25 kg
- Telescopic alu handle
- Compact packing
- Elastomer-coated wheels









		CART T
		KCT4040
		3020
	mm	396 x 370 x 960
	kg	~ 25
	pcs	- / 3
	pcs	120
	mm	~ 1930

Bucket



BUCKET funnel

BUCKET round

		KBU12L	KBU16L	KBU20L	KBU05	KBU12	KBU16	KBU20
		S411	S411	S411	S411	S411	S411	S411
	mm	310 x 240	340 x 255	365 x 280	240 x 200	310 x 240	340 x 255	365 x 280
	l	12	16	20	5	12	16	20
	pcs	-	-	-	-	-	-	-
	pcs	1000	640	480	1200	1000	640	480
	mm	~ 1850	~ 1950	~ 1950	~ 1600	~ 1850	~ 1950	~ 1950
		metal handles bent inside, building bucket with a funnel, measure			metal handles bent inside, building bucket round, measure			

BUCKET:

- Metal handles
- Measure
- Building bucket round

Container



	CONTAINER round			CONTAINER rectangular			CONTAINER rectangular	
	KCOR45	KCOR65	KCOR90	KCON40	KCON60	KCON80	KCO60	KCO80
	S411	S411	S411	S411	S411	S411	S411	S411
mm	500 x 330	580 x 350	630 x 420	-	-	-	-	-
mm	-	-	-	720 x 410 x 220	720 x 410 x 285	780 x 500 x 295	710 x 410 x 280	780 x 470 x 300
l	45	65	90	40	60	80	60	80
pcs	-	-	-	-	-	-	-	-
pcs	140	140	140	180	180	160	165	90
mm	~ 1950	~ 1950	~ 1950	~ 1850	~ 1950	~ 1800	~ 1900	~ 1750
	round building container, measure			rectangular building container, measure			rectangular building container, measure	

CONTAINER:
– Building container



This catalogue does not constitute an offer for a legal contract. All content and promotional materials contained therein are for information purposes only. Accessories and additional features presented in the catalogue may differ from the commercial offer. The colour of the products are for marketing use only and may differ from the actual colors. Tools shown in the pictures are not included.

All rights are reserved by Prosperplast 1 Spółka z o. o. and content may not be reproduced, downloaded, disseminated, published or transferred in any form or by any means, except with the prior written permission of Prosperplast 1 Spółka z o.o.

We are not responsible for printing mistakes.

Wszystkie prawa zastrzeżone przez Prosperplast 1 Spółka z o.o., a zawartość nie może być powielana, pobierana, rozpowszechniana, publikowana lub przekazywana w jakiegokolwiek formie i w jakikolwiek sposób, bez uprzedniej pisemnej zgody Prosperplast 1 Spółka z o.o.

Niniejszy katalog nie stanowi oferty w rozumieniu obowiązujących przepisów. Za błędy w druku nie odpowiadamy.

All rights are reserved by Prosperplast 1 Spółka z o. o. and content may not be reproduced, downloaded, disseminated, published, or transferred in any form or by any means, except with the prior written permission of Prosperplast 1 Spółka z o.o.

This catalogue does not constitute an offer within the meaning of applicable rules. We are not responsible for printing errors.

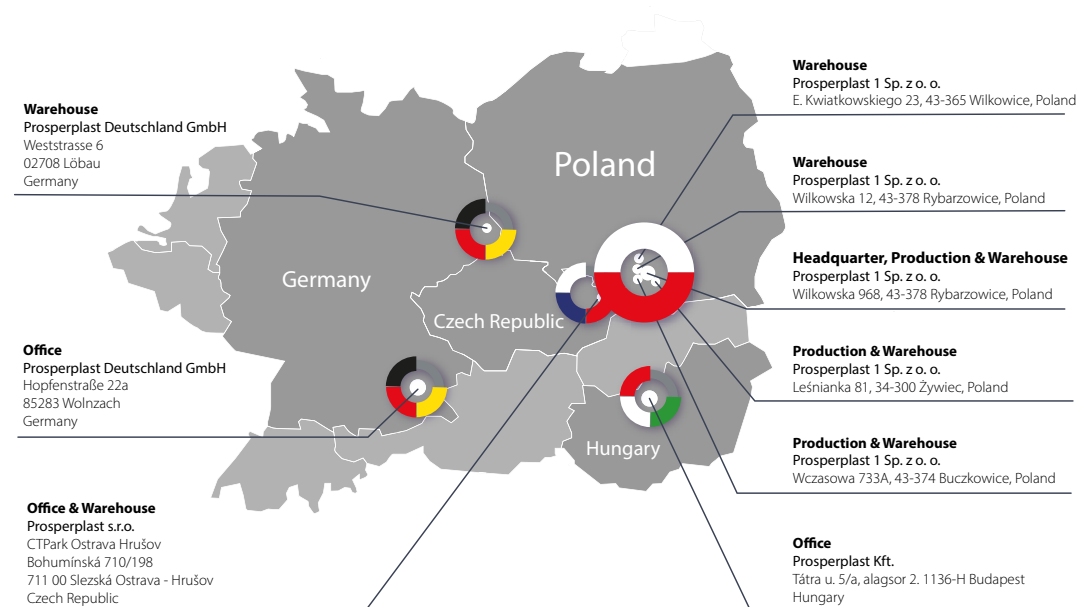

Contact us



Headquarter, Production & Warehouse

Prosperplast 1 Sp. z o. o.
Wilkowska 968
43-378 Rybarzowice
Poland

tel. +48 33 817 70 03
fax +48 33 817 60 81

biuro@prosperplast.pl
office@prosperplast.pl
www.prosperplast.pl



Office

Prosperplast Deutschland GmbH
Hopfenstraße 22a
85283 Wolnzach
Germany

tel. +49 8442 9628499
fax +49 8442 9680853

kontakt@prosperplast.de
www.prosperplast.de



Office & Warehouse

Prosperplast s.r.o.
CTPark Ostrava Hrušov
Bohumínská 710/198
711 00 Slezská Ostrava - Hrušov
Czech Republic

tel. +420 553 034 443
mob +420 605 499 544

info@prosperplast.cz
www.prosperplast.cz



Office

Prosperplast Kft.
Tátra u. 5/a, alagsor 2.
1136-H Budapest,
Hungary

tel. +36 30 4095 120
mob +36 30 4095 710

office@prosperplast.hu
www.prosperplast.hu



Prosperplast 1 Sp. z o.o.
Wilkowska 968
43-378 Rybarzowice
Poland

[kistenberg.com](https://www.kistenberg.com)

Feel free to place your order via B2B