

PATROL[®]
GROUP

DIY

BUILDING

Product Catalogue
2021 / 2022



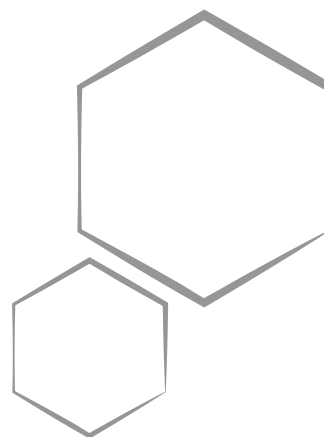

PATROL GROUP SP. Z O.O. S.K.A.

ul. Koszutki 2
30-694 Kraków

tel. +48 12 376 45 50
fax +48 12 376 45 71

patrolgroup.com
patrol@patrol.pl

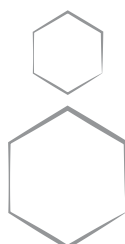

Firma Patrol Group powstała w 1991 roku i od tam buduje silną, polską markę, która skutecznie konkuruje ze światowymi liderami w produkcji artykułów z tworzyw sztucznych.

Satysfakcja Klientów Patrol Group jest najważniejszym wyzwaniem. W tym celu zbudowano zespół doświadczonych i kreatywnych specjalistów, którzy wykorzystują w swojej pracy innowacyjne technologie oraz zaawansowane urządzenia.

Dzięki ciągłej optymalizacji procesów: projektowania, produkcji i sprzedaży; oferujemy solidne, ergonomiczne i estetyczne produkty w konkurencyjnych cenach. W trosce o najwyższą jakość wyrobów Patrol Group, poddawane są one stałej kontroli wewnętrznej oraz zewnętrznemu monitoringowi i certyfikacji.

Patrol Group was founded in 1991 and since then builds a strong Polish brand that effectively competes with global leaders in the production of plastic articles. Customers' satisfaction is Patrol Group's the most important challenge.

We have built a team of experienced and creative professionals who use in their work, innovative technologies and advanced equipment. Thanks to the continuous optimization of processes: design, production and sales we offer robust, ergonomic and aesthetic products at competitive prices.

In the interest of the highest quality of Patrol Group's products, they are subjected to constant internal control and external monitoring and certification. The offered assortment will satisfy the most demanding customers.

MAMY MIĘDZYNARODOWY ZASIĘG

Our reach is global



NASZA FIRMA OD KUCHNI

Our company on the inside



Wieluń

Fabryka
Factory

Magazyn wysokiego składowania
High bay warehouse

Kraków

Centrala
Headquarters

Wzorcownia
Showroom

Dział sprzedaży
Sales department



Wieluń

10800 m²
Powierzchnia fabryki

5105 m²
Powierzchnia magazynu
wysokiego składowania

15000 m²
Powierzchnia
magazynowa

76
Maszyny
Wtryskowe































Kraków

540 m²
Narzędziownia

180 m²
Powierzchnia
showroomu

DO IT YOURSELF

	Toolboxes Skrzynki Narzędziowe	8
	HD	10
	HD Wheelbox Trophy	16
	HD Wheelbox Compact	18
	HD Wheelbox Compact Logic	20
	HD Case	22
	Formula	24
	Formula S Carbo	26
	Formula RS Carbo	28
	Formula RS Carbo Flex	30
	Formula S	32
	Formula A	34
	Stuff Carbo	36
	Stuff Module System Carbo	40
	Stuff	42
	Stuff Module System	58
	Stuff Wheelbox	64
	Tool Case	66

	Organizers Organizery	70
	HD	72
	Tandem	78
	Domino	84
	Classic	88
	Combibox	92
	Workshop Warsztat	94
	Ecobox/Ergobox	96
	Fixing Wall	104
	Pegboard Kit	106
	Tool Wall Panel	108
	Workshop accessories Akcesoria warsztatowe	112
	Multifunctional boxes Pojemniki wielofunkcyjne	116

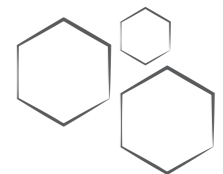

BUILDING

	Buckets Wiadra	120
	Containers Kastry	124

TOOLBOXES

SKRZYNKI NARZĘDZIOWE

Toolboxes dedicated for DIY enthusiasts and professional users. Perfect for storing basic tools.

For transporting heavier tools safely, we offer toolboxes on wheels with comfortable handles. Additional organizers in the lids of many models of our toolboxes are designed for storing small items.

Skrzynki narzędziowe dedykowane dla domowych majsterkowiczów jak i profesjonalnych użytkowników. Doskonale do przechowywania podstawowych narzędzi.

Do bezpiecznego przewożenia cięższych narzędzi oferujemy skrzynie na kółkach z wygodnymi rączkami. Dodatkowe organizery w pokrywach wielu modeli naszych skrzyń są przeznaczone do magazynowania drobnych przedmiotów.

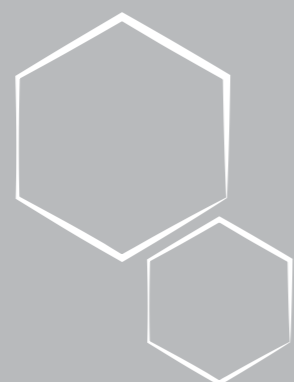

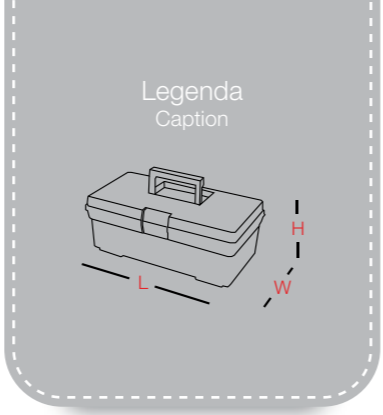

Toolboxes HD

Skrzynki narzędziowe HD



Available colours
Dostępne kolory



Measure - placed on the cover of Toolbox HD Compact.
Miarka - wbudowana w pokrywę skrzynki HD Compact.



HD Alu handle - solid, elongated handle makes it possible to lift the box with both hands, thus facilitating the transport of your box, even when it is filled with heavy tools.



Polyamide latches - very solid, durable and light.
Zapięcia poliamidowe - bardzo wytrzymałe, odporne oraz lekkie.



Side handles - help you to carry Toolbox filled with heavy tools.
Uchwyty boczne - ułatwiają przenoszenie maksymalnie obciążonej skrzynki.



Tool holster - easy to assemble, ideal additional to HD Toolboxes. Allows you to store and transport power tools and accessories.
Kabura Narzędziowa - łatwa w montażu, stanowiąca doskonały dodatek do skrzynki narzędziowej HD. Pozwala na przechowywanie i przenoszenie elektronarzędzi oraz akcesoriów.



Anti-slip - lower corners of the box are made of anti-slip elasto. They give the bottom added protection against damage in case of accidental dropping.
Nóżki - wykonane są z antypoślizgowego elastomeru zwanego adflex. Chronią dodatkowo jej spód przed pękaniem przy upuszczeniach.



Portable workshop - thanks to a specially made handle, you can transform your box into a mini tool table.



Carriage - it is equipped with holes for smaller elements, such as keys, screwdrivers or measuring tape - in this way, all tools are readily accessible.
Nosidło - posiada otwory przeznaczony dla mniejszych elementów, takie jak klucze, śrubokręty czy taśmę mierniczą, dzięki którym otrzymuje się łatwy dostęp do wszystkich narzędzi.

*tools not included/nie zawiera narzędzi



Specially designed cover facilitates trimming various kinds of materials.
Wyprofilowana pokrywka ułatwia przycinanie różnego rodzaju materiałów.



Expert organizer - located on the cover, helps to keep small elements in order, and pull-out partitions enable to adjust their sizes to the size of tools.

Organizer Expert - umiejscowiony na całej powierzchni pokrywki, pozwala na łatwe utrzymanie porządku wśród drobnych elementów, a wysuwane przegrody umożliwiają dopasowanie ich wielkości do rozmiarów posiadanych narzędzi.



*Optional metal latches - very durable steel latches are available as an alternative to our standard polyamide latches.

*Opcjonalne metalowe zapięcia - bardzo wytrzymałe zapięcia ze stali, stanowiące alternatywę dla naszych standardowych poliamidowych zapięć.



Portable workshop - thanks to a specially made handle, you can transform your box into a mini tool table.

Mini warsztat - dzięki specjalnemu uchwytowi, możliwa jest przemiana skrzynki w mini stół narzędziowy.

HD Compact 1 and HD Trophy 1 offer the possibility of sitting or standing on their covers.

HD Compact 1 i HD Trophy 1 umożliwiają stanie lub siedzenie na ich pokrywach.



WATERPROOF DUSTPROOF

The special construction of the lid and the body of HD toolboxes gives them a high resistance to water splashes and harmful effects of dust. Quality confirmed by certified IP54!

Specjalna konstrukcja pokrywki oraz korpusu skrzynki z linii HD zapewnia im wysoką odporność na zachlapania wodą i szkodliwy wpływ kurzu. Jakość potwierdzona przez certyfikat IP54!

*tools not included/nie zawiera narzędzi





Toolbox HD Compact Logic

Skrzynka narzędziowa HD Compact Logic

Product info

informacje o produkcie

445 [L] x 350 [W] x 300 [H] mm 360 [L] x 315 [W] x 260 [H] mm

Colour	Index	EAN		
	SKRCLHDPZCZEPG001	5901238248941	42	6
	SKRCLHDPZCZAPG001	5901238249436	42	6
	SKRCLHDPZPOMPG001	5901238253167	42	6



- 4 x Organizer on lid
4 x Organizer w pokrywie
- Polyamide latches
Poliamidowe zapięcia
- Anti-slip legs
Antypoślizgowe nóżki
- Polycarbonate on lid
Poliwęglanowe pokrywy organizerów
- Deep tray
Głęboka tacka
- HD handle
Rączka HD



Available colours



Toolbox HD Compact 2

Skrzynka narzędziowa HD Compact 2

Product info

informacje o produkcie

450 [L] x 350 [W] x 350 [H] mm 360 [L] x 300 [W] x 270 [H] mm

Colour	Index	EAN		
	SKRC2HDPZCZEPG001	5901238249450	36	6
	SKRC2HDPZCZAPG001	5901238249467	36	6
	SKRC2HDPZPOMPG001	5901238252917	36	6

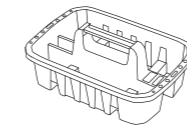

Optional: Carriage Basic
Opcjonalnie: Nosidło Basic



Optional: Tool Holders
Opcjonalnie: Kabury narzędziowe

Available colours







Toolbox HD Compact 1

Skrzynka narzędziowa HD Compact 1

Product info

informacje o produkcie

450 [L] x 350 [W] x 350 [H] mm 360 [L] x 300 [W] x 270 [H] mm

Colour	Index	EAN		
	SKRC1HDPZCZEPG001	5901238249443	36	6
	SKRC1HDPZCZAPG001	5901238248958	36	6
	SKRC1HDPZPOMPG001	5901238252870	36	6

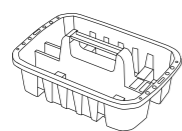

Optional: Carriage Basic
Opcjonalnie: Nosidło Basic



Optional: Tool Holders
Opcjonalnie: Kabury narzędziowe

- HD Alu handle
Alu rączka HD
- Polyamide latches
Poliamidowe zapięcia
- Deep tray
Głęboka tacka
- Anti-slip legs
Antypoślizgowe nóżki
- Portable workshop
Mini warsztat
- 40 cm measure on lid
40 cm miarka w pokrywie



Available colours



Toolbox HD Compact 2 Carbo

Skrzynka narzędziowa HD Compact 2 Carbo

Product info

informacje o produkcie

450 [L] x 350 [W] x 350 [H] mm 360 [L] x 300 [W] x 270 [H] mm

Colour	Index	EAN		
	SKRC2HDCPZCZEPG001	5901238251156	36	6
	SKRC2HDCPZCZAPG001	5901238251170	36	6
	SKRC2HDCPZPOMPG001	5901238253068	36	6

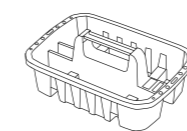

Optional: Carriage Basic
Opcjonalnie: Nosidło Basic



Optional: Tool Holders
Opcjonalnie: Kabury narzędziowe

- HD Alu handle
Alu rączka HD
- Polyamide latches
Poliamidowe zapięcia
- Deep tray
Głęboka tacka
- Anti-slip legs
Antypoślizgowe nóżki
- Portable workshop
Mini warsztat



Available colours







Toolbox HD Trophy 1

Skrzynka narzędziowa HD Trophy 1

Product info

informacje o produkcie

595 [L] x 345 [W] x 355 [H] mm 515 [L] x 270 [W] x 270 [H] mm

Colour	Index	EAN		
	SKRT1HDPZCZEPG001	5901238249641	24	4
	SKRT1HDPZCZAPG001	5901238249634	24	4
	SKRT1HDPZPOMPG001	5901238252955	24	4



Optional: Tool Holsters
Opcjonalnie: Kabury narzędziowe

Available colours

Dostępne kolory



- HD Alu handle
Alu rączka HD
- Polyamide latches
Polamidowe zapięcia
- Carriage
Nosidło
- Anti-slip legs
Antypoślizgowe nóżki
- Portable workshop
Mini warsztat
- 50 cm measure on lid
50 cm miarka w pokrywie







Toolbox HD Trophy 2

Skrzynka narzędziowa HD Trophy 2

Product info

informacje o produkcie

595 [L] x 345 [W] x 355 [H] mm 515 [L] x 260 [W] x 275 [H] mm

Colour	Index	EAN		
	SKRT2HDPZCZEPG001	5901238249702	24	4
	SKRT2HDPZCZAPG001	5901238249696	24	4
	SKRT2HDPZPOMPG001	5901238252993	24	4



Optional: Tool Holsters
Opcjonalnie: Kabury narzędziowe

Available colours

Dostępne kolory



- HD Alu handle
Alu rączka HD
- Polyamide latches
Polamidowe zapięcia
- Carriage
Nosidło
- Side handles
Uchwyty boczne
- Anti-slip legs
Antypoślizgowe nóżki
- Portable workshop
Mini warsztat
- Expert organizer
Organizer expert



Toolbox HD Trophy 2 Carbo

Skrzynka narzędziowa HD Trophy 2 Carbo

Product info

informacje o produkcie

595 [L] x 345 [W] x 355 [H] mm 515 [L] x 260 [W] x 275 [H] mm

Colour	Index	EAN		
	SKRT2HDCPZCZEPG001	5901238249764	24	4
	SKRT2HDCPZCZAPG001	5901238249757	24	4
	SKRWT2HDCPZPOMPG001	5901238253082	24	4



Optional: Tool Holsters
Opcjonalnie: Kabury narzędziowe

Available colours

Dostępne kolory



- HD Alu handle
Alu rączka HD
- Polyamide latches
Polamidowe zapięcia
- Carriage
Nosidło
- Anti-slip legs
Antypoślizgowe nóżki
- Portable workshop
Mini warsztat
- Polycarbonate on lid
Poliwęglanowe pokrywy organizatorów
- Expert organizer
Organizer expert





Wheelbox HD Trophy

Skrzynki narzędziowe na kółkach HD

Available colours
Dostępne kolory

Wheelbox HD Trophy provides users high comfort and ergonomics. This is possible thanks to the tough, reinforced construction of the box. Telescopic handle with ability of adjustment, and plastic wheels protected with rubber layer makes, that carrying the tools will not cause you a problem.

Wheelbox HD Trophy zapewnia użytkownikom wysoki komfort i ergonomię pracy. Jest to możliwe dzięki przemysłowej, wzmocnionej konstrukcji tej skrzynki. Teleskopowa rączka z możliwością precyzyjnej regulacji oraz plastikowe kółka zabezpieczone warstwą gumy sprawiają, że przenoszenie narzędzi nie będzie sprawiać problemu.



Plastic wheels – the rubber layer protects them from mechanical defects.



Wheel HD Alu handle – drawn handle is comfortable to use. It allows you to save the place during transport and storage.

Rączka aluminiowa Wheel HD – zastosowana rozkładana rączka jest wygodna w użyciu i pozwala na oszczędność miejsca podczas transportu i magazynowania.

Kółka z plastiku są zabezpieczone warstwą gumy zapewniającej odporność na uszkodzenia mechaniczne.



Inside the toolbox
Carriage Basic
W środku skrzynki
Nosidło Basic

Carriage Basic use also with:
Nosidło Basic używaj również z:

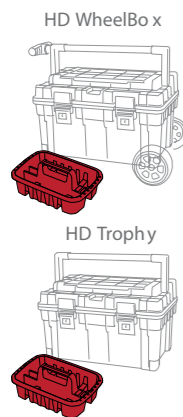

Wheelbox HD Trophy 1

Skrzynka narzędziowa HD Trophy 1

Product info

informacje o produkcie

710 [L] x 400 [W] x 355 [H] mm 515 [L] x 265 [W] x 270 [H] mm

Colour	Index	EAN		
	SKRWT1HDPZCZEPG001	5901238249825	15	3
	SKRWT1HDPZCZAPG001	5901238249818	15	3
	SKRWT1HDPZPOMPG001	5901238253037	15	3



Optional:
Tool Holsters
Opcjonalnie:
Kabury narzędziowe

Plastic wheels with rubber layer
Plastikowe koła z warstwą gumy

Wheel Alu Handle HD
Alu rączka HD

Polyamide latches
Zapięcia poliamidowe

Carriage
Nosidło

Anti-slip legs
Antypoślizgowe nóżki

Portable workshop
Mini warsztat



Available colours
Dostępne kolory

Wheelbox HD Trophy 2

Skrzynka narzędziowa HD Trophy 2

Product info

informacje o produkcie

710 [L] x 400 [W] x 355 [H] mm 515 [L] x 265 [W] x 270 [H] mm

Colour	Index	EAN		
	SKRWT2HDPZCZEPG001	5901238249887	15	3
	SKRWT2HDPZCZAPG001	5901238249870	15	3
	SKRWT2HDPZPOMPG001	5901238253044	15	3



Organizer scheme
Rozkład organizera



Optional:
Tool Holsters
Opcjonalnie:
Kabury narzędziowe

Plastic wheels with rubber layer
Plastikowe koła z warstwą gumy

HD Alu Handle
Alu rączka HD

Polyamide latches
Zapięcia poliamidowe

Carriage
Nosidło

Anti-slip legs
Antypoślizgowe nóżki

Portable workshop
Mini warsztat

Ekspert organizer
Organizer ekspert



Available colours
Dostępne kolory

Wheelbox HD Trophy 2 Carbo

Skrzynka narzędziowa HD Trophy 2 Carbo

Product info

informacje o produkcie

710 [L] x 400 [W] x 355 [H] mm 515 [L] x 265 [W] x 270 [H] mm

Colour	Index	EAN		
	SKRWT2HDCPZCZEPG001	5901238249948	15	3
	SKRWT2HDCPZCZAPG001	5901238249931	15	3
	SKRWT2HDCPZPOMPG001	5901238251958	15	3



Organizer scheme
Rozkład organizera



Optional:
Tool Holsters
Opcjonalnie:
Kabury narzędziowe

Plastic wheels with rubber layer
Plastikowe koła z warstwą gumy

HD Alu Handle
Alu rączka HD

Polyamide latches
Zapięcia poliamidowe

Carriage
Nosidło

Anti-slip legs
Antypoślizgowe nóżki

Portable workshop
Mini warsztat

Ekspert organizer
Organizer ekspert



Available colours
Dostępne kolory



Wheelbox HD Compact

Skrzynka narzędziowa na kółkach HD Compact

Available colors
Dostępne kolory ●

Handle to pull with locking system
Rączka do ciągnięcia z systemem blokowania
Handle to lift
Rączka do podnoszenia

Strong polycarbonate organizers covers
Mocne poliwęglanowe pokrywy organizatorów

Polyamide latches
Zapięcia poliamidowe

Solid traction system with metal axle
Solidny system jezdny z metalową osią

Plastic wheels covered with a protective layer of rubber
Plastikowe koła pokryte zabezpieczającą warstwą gumy



Easy access
Łatwy dostęp



Ergobox 2 Plus on both sides
Ergobox 2 Plus po obu stronach



Large tools container
Duży pojemnik na narzędzia



4 x Portable Ergobox 2 Plus
4 x Wyjmowany Ergobox 2 Plus

Tray
Tacka



4 functional organizers
4 funkcjonalne organizery



Supporting slot
Szczelina pozycjonująca



Lock handle
System blokowania rączki



Measure
Miarka

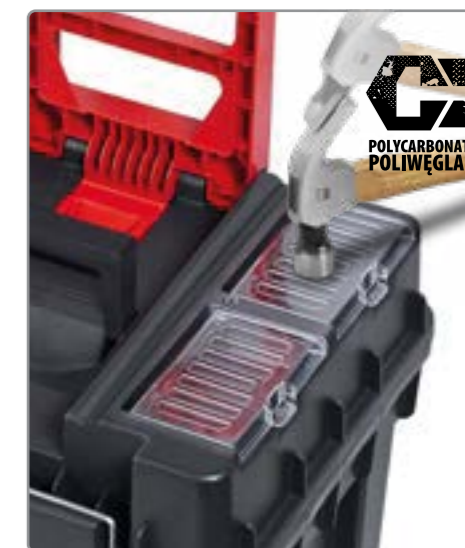

Organizers covers impact resistant
Pokrywy organizatorów odporne na uderzenia

Wheelbox HD Compact

Skrzynka narzędziowa HD Compact

Product info

informacje o produkcie

495 [L] x 360 [W] x 710 [H] mm 360 [L] x 315 [W] x 275 [H] mm

Colour	Index	EAN		
Black	SKRWC1HDPZCZAPG001	5901238248965	13	5

Plastic wheels with rubber layer
Plastikowe koła z warstwą gumy

Metal axle
Metalowa oś

HD Alu Handle
Alu rączka HD

Polyamide latches
Zapięcia poliamidowe

Polycarbonate organizers covers
Poliwęglanowe pokrywy organizatorów

Deep tray
Głęboka tacka

4x Ergobox 2 Plus
4x Ergobox 2 Plus

4x Organizers on lids
4x Organizery w pokrywie



HD Compact Module System

Skrzynka narzędziowa HD Compact Module System

Product info

informacje o produkcie

450 [L] x 350 [W] x 450 [H] mm 360 [L] x 300 [W] x 270 [H] mm

Colour	Index	EAN		
Black	SKRC1HDSMSPZCZAPG001	5901238253051	24	6

HD Alu Handle
Alu rączka HD

Polyamide latches
Zapięcia poliamidowe

Deep tray
Głęboka tacka

Anti-slip legs
Antypoślizgowe nóżki

40 cm measure on cover
40 cm miarka w pokrywie





Wheelbox HD Compact Logic

Skrzynka narzędziowa
na kółkach HD Compact Logic

Available colors
Dostępne kolory

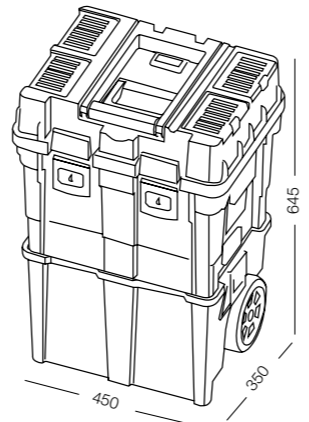

Handle to pull with locking system
Rączka do ciągnięcia z systemem blokowania

Handle to lift
Rączka do podnoszenia

Strong polycarbonate organizers covers
Mocne poliwęglanowe pokrywy organizatorów

Polyamide latches
Poliamidowe zapięcia

Large tools container
Duży pojemnik na narzędzia

Plastic wheels covered with a protective layer of rubber
Plastikowe koła pokryte zabezpieczającą warstwą gumy



Tray
Tacka

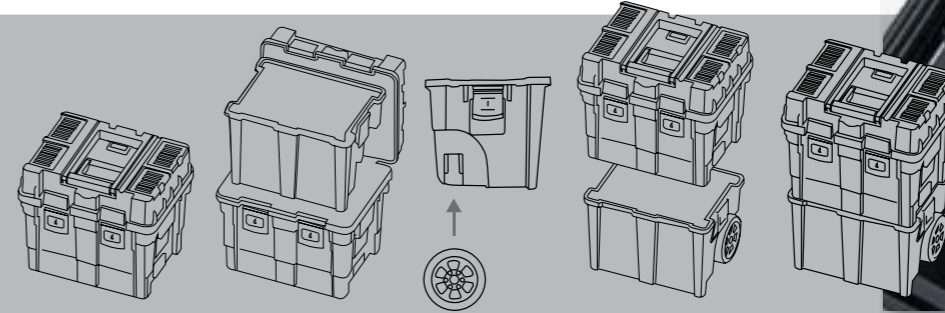

Assembled

Zmontowana

Wheelbox HD Compact Logic

Skrzynka narzędziowa HD Compact Logic

Product info

informacje o produkcie

450 [L] x 350 [W] x 645 [H] mm 360 [L] x 300 [W] x 260 [H] mm

Colour	Index	EAN		
	SKRWCLHDPZCZAPG001	5901238248934	18	6

Plastic wheels with rubber layer
Kółka z plastiku zabezpieczone warstwą gumy

HD Handles
Rączki HD

Metal latches
Metalowe zapięcia

Polycarbonate organizers covers
Poliwęglanowe pokrywy organizatorów

Deep tray
Głęboka tacka

4 organizers on lid
4 organizery w pokrywie



Disassembled

Rozmontowana

Wheelbox HD Compact Logic

Skrzynka narzędziowa HD Compact Logic

Product info

informacje o produkcie

450 [L] x 350 [W] x 390 [H] mm 360 [L] x 300 [W] x 260 [H] mm

Colour	Index	EAN		
	SKRWCLHDPZCZAPG002	5901238249474	30	6

Plastic wheels with rubber layer
Kółka z plastiku zabezpieczone warstwą gumy

HD Handles
Rączki HD

Metal latches
Metalowe zapięcia

Polycarbonate organizers covers
Poliwęglanowe pokrywy organizatorów

Deep tray
Głęboka tacka

4 organizers on lid
4 organizery w pokrywie





Plastic latches
plastikowe zapięcia

Reinforced ribs
Żebra wzmacniające

Large Capacity
Duża pojemność

Safety straps
Paski ochronne

Protective foam layer
Gąbka ochronna

Solid handle
Wytrzymała rączka

Two Expert organizers
Dwa organizery Expert

HD Case

Pojemnik na elektronarzędzia HD

Available colors
Dostępne kolory



Solid, double adjustable straps are made of a material with high impact strength. Strips allow you to protect tools from movement, and hence possible damage.

Solidne, obustronnie regulowane paski zostały wykonane z surowca o wysokiej wytrzymałości. Paski pozwalają zabezpieczyć narzędzia przed ruchem, a co za tym idzie możliwymi uszkodzeniami.



Reinforced ribs - extra ribs composed in cover significantly increase box durability.

Żebra wzmacniające – dodatkowe żebra znajdujące się w pokrywach znacząco podwyższają wytrzymałość skrzynki.



Protective foam layer on steel plate – protect tools against mechanical damages.

Gąbka ochronna na stalowej płycie – chroni narzędzia przed uszkodzeniami mechanicznymi.



Expert organizers – located on both sides of cover allow you to separate small accessories. That will let you will find the elements you need much faster.

Organizery Expert – znajdujące się po obu stronach pokrywy umożliwiają posegregowanie drobnych akcesoriów i łatwiejszy do nich dostęp.



*tools not included/nie zawiera narzędzi



Powertool HD Case

Pojemnik na elektronarzędzia HD Case

Product info

informacje o produkcie

600 [L] x 240 [W] x 380 [H] mm

Colour	Index	EAN		
	ELEKTROHDCZAPG001	5901238217916	32	4



Safety straps
Paski zabezpieczające

Protective foam
Gąbka ochronna

Steel plates
Płyta stalowa

Reinforced ribs
Żebra wzmacniające

Organizers x 2
Organizery x 2

Comfortable handle
Wygodna rączka





Powertool HD Case Carbo

Pojemnik na elektronarzędzia HD Case Carbo

Product info

informacje o produkcie

600 [L] x 240 [W] x 380 [H] mm

Colour	Index	EAN		
	ELEKTROHDCARCZAPG001	5901238244868	32	4



Safety straps
Paski zabezpieczające

Protective foam
Gąbka ochronna

Steel plates
Płyta stalowa

Reinforced ribs
Żebra wzmacniające

Organizers x 2
Organizery x 2

Comfortable handle
Wygodna rączka





Toolboxes

FORMULA

Skrzynki narzędziowe Formula

Sturdiness, functionality, contemporary design are definitely features you can use to describe Formula Toolboxes (series A, S, RS, RS Flex). They come in three sizes 500, 600 and 700, while in A series there's one small box - 300. Organizers in lids, ergonomic handles, handheld tooltable functionality are common for every model in our Formula line. Formula A are black with silver latches and black sturdy handles. Formula S, on the other hand, contains 2 to 3 organizers depending on the size of the toolbox and their insides are protected by aluminum latches. Formula RS has one big organizer filled with combiboxes in 4 sizes. RS Flex has an organizer that's compartmentalised with dividers enabling a lot of customization. S, RS and RS Flex have sturdy aluminum handles that even further up their ergonomics and comfort of use. Additionally, those lines have aluminum latches and an optional double tray for even more usability.

Trwałość, funkcjonalność, nowoczesny design to bez wątpienia cechy skrzynek narzędziowych z linii FORMUŁA (seria A, S, RS, RS Flex). Występują w trzech rozmiarach 500, 600 oraz 700, a w linii Formula A znajduje się dodatkowo najmniejsza skrzynka 300. Organizery w pokrywie, wygodne ręczki, funkcjonalność stołu roboczego po otwarciu pokrywy to cechy wspólne dla wszystkich modeli skrzynek narzędziowych występujących w tej linii produktowej. Formula A to skrzynki w czarnych kolorach ze srebrnymi zapięciami i czarną rączką z wytrzymałego tworzywa. Z kolei Formula S zawiera od dwóch do trzech organizatorów w zależności od wielkości skrzynki, a jej zawartość zabezpieczają aluminiowe zapięcia. Formula RS posiada jeden duży organizator z pojemnikami Combibox w czterech rozmiarach. Z kolei Formula RS FLEX zawiera organizator z wyjmowanymi przegrodami pozwalającymi na samodzielną organizację jego wewnętrznej przestrzeni. Wersje S, RS i RS Flex posiadają specjalnie zaprojektowane ręczki z aluminium, co znacznie zwiększa ich wytrzymałość i poprawia komfort użytkowania. Dodatkowo w tych liniach występują aluminiowe zapięcia oraz opcjonalnie dwupoziomowa tacka z dwoma organizerami i otworami na nasadki oraz bity.

Toolboxes FORMULA | S CARBO

Skrzynki narzędziowe Formula S Carbo

Available colours
Dostępne kolory



Legenda
Caption

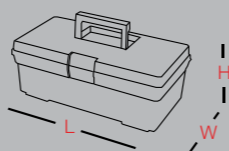

Formula S Organizers
Organizery Formula S



Super strong covers
Super wytrzymałe pokrywy



Alu handle
Aluminiowa rączka

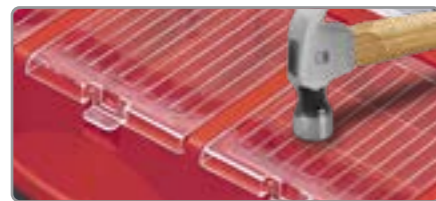

Padlock hole
Miejsce na kłódkę



Aluminium latches
Aluminiowe zapięcia



Mini tool table
Mini warsztat

Optional:
Two-level tray
Opcjonalnie:
Dwupoziomowa taca



Optional:
Polyamide latches
Opcjonalnie:
Zapięcia poliamidowe



Toolbox Formula S 500 Carbo

Skrzynka narzędziowa Formula S 500 Carbo

Product info
informacje o produkcie

462 [L] x 256 [W] x 242 [H] mm 450 [L] x 230 [W] x 170 [H] mm

Colour	Index	EAN		
	SKRS500FCARCZEPG001	5901238231998	56	7
	SKRS500FCARCZAPG001	5901238242444	56	7
	SKRS500FCARPOMPG001	5901238231981	56	7
	SKRS500FCARNIEPG001	5901238232001	56	7

Organizer scheme
Rozkład organizera



Optional: Two level tray
Opcjonalnie: Dwupoziomowa taca



Optional: Polyamide latches
Opcjonalnie: Zapięcia poliamidowe

Formula Alu handle
Aluminiowa rączka Formula

Deep tray organizer with sockets and bits storage
Głęboka taca z otworami na nasadki i bity

Side handles
Uchwyty boczne

Padlock hole
Miejsce na kłódkę

Portable workshop
Mini warsztat



Available colours
Dostępne kolory



Toolbox Formula S 600 Carbo

Skrzynka narzędziowa Formula S 600 Carbo

Product info
informacje o produkcie

547 [L] x 271 [W] x 278 [H] mm 530 [L] x 250 [W] x 185 [H] mm

Colour	Index	EAN		
	SKRS600FCARCZEPG001	5901238225218	42	6
	SKRS600FCARCZAPG001	5901238242451	42	6
	SKRS600FCARPOMPG001	5901238225195	42	6
	SKRS600FCARNIEPG001	5901238225232	42	6

Organizer scheme
Rozkład organizera



Optional: Two level tray
Opcjonalnie: Dwupoziomowa taca



Optional: Polyamide latches
Opcjonalnie: Zapięcia poliamidowe

Formula Alu handle
Aluminiowa rączka Formula

Deep tray organizer with sockets and bits storage
Głęboka taca z otworami na nasadki i bity

Side handles
Uchwyty boczne

Padlock hole
Miejsce na kłódkę

Portable workshop
Mini warsztat



Available colours
Dostępne kolory



Toolbox Formula S 700 Carbo

Skrzynka narzędziowa Formula S 700 Carbo

Product info
informacje o produkcie

595 [L] x 289 [W] x 328 [H] mm 580 [L] x 270 [W] x 210 [H] mm

Colour	Index	EAN		
	SKRS700FCARCZEPG001	5901238232049	36	6
	SKRS700FCARCZAPG001	5901238242468	36	6
	SKRS700FCARPOMPG001	5901238232032	36	6
	SKRS700FCARNIEPG001	5901238232056	36	6

Organizer scheme
Rozkład organizera



Optional: Two level tray
Opcjonalnie: Dwupoziomowa taca



Optional: Polyamide latches
Opcjonalnie: Zapięcia poliamidowe

Formula Alu handle
Aluminiowa rączka Formula

Deep tray organizer with sockets and bits storage
Głęboka taca z otworami na nasadki i bity

Side handles
Uchwyty boczne

Padlock hole
Miejsce na kłódkę

Portable workshop
Mini warsztat



Available colours
Dostępne kolory

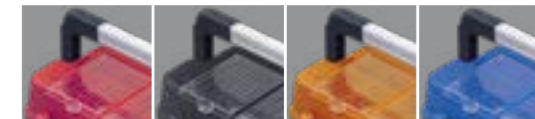

FORMULA
CARBO



POLYCARBONATE
POLIWEGLAN

Toolboxes | FORMULA RS CARBO

Skrzynki narzędziowe Formuła RS Carbo

Available colours
Dostępne kolory

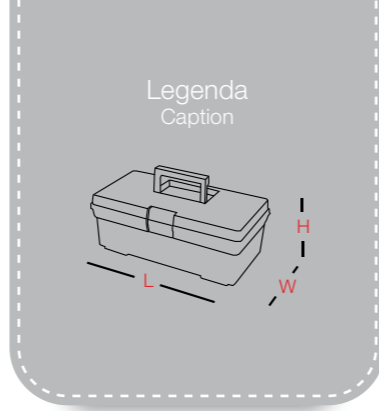

Storage containers
inside the cover
Wymowane pojemniki
w pokrywie



Super strong covers
Super wytrzymałe
pokrywy



Alu handle
Alumiowa rączka



Padlock hole
Miejsce na kłódkę



Aluminium latches
Aluminiowe zapięcia



Mini tool table
Mini warsztat

Optional:
Two-level tray
Opcjonalnie:
Dwupoziomowa taca



Optional:
Polyamide latches
Opcjonalnie:
Zapięcia poliamidowe



Toolbox Formula RS 500 Carbo

Skrzynka narzędziowa Formuła RS 500 Carbo

Product info
informacje o produkcie

462 [L] x 256 [W] x 242 [H] mm 450 [L] x 230 [W] x 170 [H] mm

Colour	Index	EAN		
	SKRRS500FCARCZEPG001	5901238232681	56	7
	SKRRS500FCARCZAPG001	5901238242475	56	7
	SKRRS500FCARPOMPG001	5901238232674	56	7
	SKRRS500FCARNEPG001	5901238232698	56	7

Organizer scheme
Rozkład organizera



Formula Alu handle
Alumiowa rączka Formuła

Deep tray organizer with
sockets and bits storage
Głęboka taca z otworami
na nasadki i bity

Side handles
Uchwyty boczne

Padlock hole
Miejsce na kłódkę

Portable workshop
Mini warsztat



Available colours
Dostępne kolory

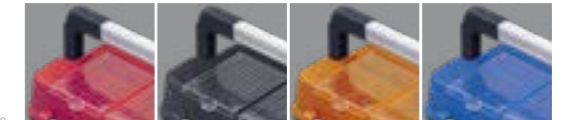

Toolbox Formula RS 600 Carbo

Skrzynka narzędziowa Formuła RS 600 Carbo

Product info
informacje o produkcie

547 [L] x 271 [W] x 278 [H] mm 530 [L] x 250 [W] x 185 [H] mm

Colour	Index	EAN		
	SKRRS600FCARCZEPG001	5901238225294	42	6
	SKRRS600FCARCZAPG001	5901238242482	42	6
	SKRRS600FCARPOMPG001	5901238225270	42	6
	SKRRS600FCARNEPG001	5901238225317	42	6

Organizer scheme
Rozkład organizera



Formula Alu handle
Alumiowa rączka Formuła

Deep tray organizer with
sockets and bits storage
Głęboka taca z otworami
na nasadki i bity

Side handles
Uchwyty boczne

Padlock hole
Miejsce na kłódkę

Portable workshop
Mini warsztat



Available colours
Dostępne kolory



Toolbox Formula RS 700 Carbo

Skrzynka narzędziowa Formuła RS 700 Carbo

Product info
informacje o produkcie

595 [L] x 289 [W] x 328 [H] mm 580 [L] x 270 [W] x 210 [H] mm

Colour	Index	EAN		
	SKRRS700FCARCZEPG001	5901238232735	36	6
	SKRRS700FCARCZAPG001	5901238242499	36	6
	SKRRS700FCARPOMPG001	5901238232742	36	6
	SKRRS700FCARNEPG001	5901238232728	36	6

Organizer scheme
Rozkład organizera



Formula Alu handle
Alumiowa rączka Formuła

Deep tray organizer with
sockets and bits storage
Głęboka taca z otworami
na nasadki i bity

Side handles
Uchwyty boczne

Padlock hole
Miejsce na kłódkę

Portable workshop
Mini warsztat



Available colours
Dostępne kolory



Toolboxes | FORMULA **RS** **CARBO Flex**

Skrzynki narzędziowe Formuła RS Carbo Flex

Available colours
Dostępne kolory

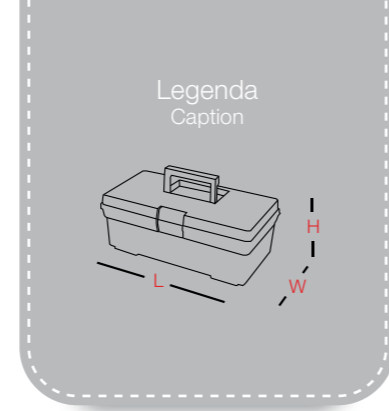

Adjustable dividers
Regulowane przegrody



Super strong covers
Super wytrzymałe pokrywy



Alu handle
Alumiowa rączka

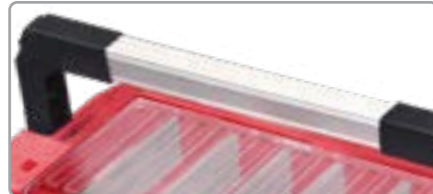

Optional:
Two-level tray
Opcjonalnie:
Dwupoziomowa taca



Padlock hole
Miejsce na kłódkę



Aluminium latches
Aluminiowe zapięcia



Mini tool table
Mini warsztat



Optional:
Polyamide latches
Opcjonalnie:
Zapięcia poliamidowe



Toolbox Formula RS 500 Carbo Flex

Skrzynka narzędziowa Formuła RS 500 Carbo Flex

Product info
informacje o produkcie

462 [L] x 256 [W] x 242 [H] mm 450 [L] x 230 [W] x 170 [H] mm

Colour	Index	EAN		
	SKRRS500FCAFCZEPG001	5901238238041	56	7
	SKRRS500FCAFCZAPG001	5901238242505	56	7
	SKRRS500FCAFPOMPG001	5901238238058	56	7
	SKRRS500FCAFNIPEG001	5901238237426	56	7

Organizer scheme
Rozkład organizera



Optional: Two level tray
Opcjonalnie: Dwupoziomowa taca



Optional: Polyamide latches
Opcjonalnie: Zapięcia poliamidowe

Formula Alu handle
Alumiowa rączka Formuła

Deep tray organizer with sockets and bits storage
Głęboka taca z otworami na nasadki i bity

Side handles
Uchwyty boczne

Padlock hole
Miejsce na kłódkę

Portable workshop
Mini warsztat



Available colours
Dostępne kolory

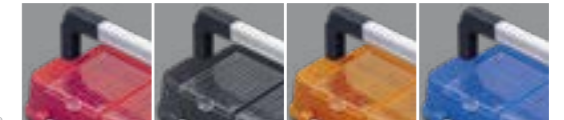

Toolbox Formula RS 600 Carbo Flex

Skrzynka narzędziowa Formuła RS 600 Carbo Flex

Product info
informacje o produkcie

547 [L] x 271 [W] x 278 [H] mm 530 [L] x 250 [W] x 185 [H] mm

Colour	Index	EAN		
	SKRRS600FCAFCZEPG001	5901238238065	42	6
	SKRRS600FCAFCZAPG001	5901238242512	42	6
	SKRRS600FCAFPOMPG001	5901238238072	42	6
	SKRRS600FCAFNIPEG001	5901238236993	42	6

Organizer scheme
Rozkład organizera



Optional: Two level tray
Opcjonalnie: Dwupoziomowa taca



Optional: Polyamide latches
Opcjonalnie: Zapięcia poliamidowe

Formula Alu handle
Alumiowa rączka Formuła

Deep tray organizer with sockets and bits storage
Głęboka taca z otworami na nasadki i bity

Side handles
Uchwyty boczne

Padlock hole
Miejsce na kłódkę

Portable workshop
Mini warsztat



Available colours
Dostępne kolory



Toolbox Formula RS 700 Carbo Flex

Skrzynka narzędziowa Formuła RS 700 Carbo Flex

Product info
informacje o produkcie

595 [L] x 289 [W] x 328 [H] mm 580 [L] x 270 [W] x 210 [H] mm

Colour	Index	EAN		
	SKRRS700FCAFCZEPG001	5901238237044	36	6
	SKRRS700FCAFCZAPG001	5901238242529	36	6
	SKRRS700FCAFPOMPG001	5901238237037	36	6
	SKRRS700FCAFNIPEG001	5901238237020	36	6

Organizer scheme
Rozkład organizera



Optional: Two level tray
Opcjonalnie: Dwupoziomowa taca



Optional: Polyamide latches
Opcjonalnie: Zapięcia poliamidowe

Formula Alu handle
Alumiowa rączka Formuła

Deep tray organizer with sockets and bits storage
Głęboka taca z otworami na nasadki i bity

Side handles
Uchwyty boczne

Padlock hole
Miejsce na kłódkę

Portable workshop
Mini warsztat



Available colours
Dostępne kolory

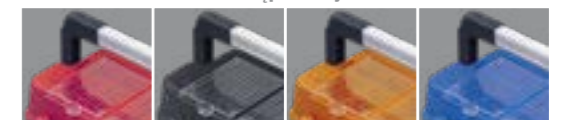



Legenda
Caption

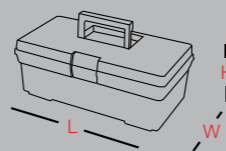

Toolboxes FORMULA | S

Skrzynki narzędziowe Formuła S

Available colours
Dostępne kolory



Formula Alu handle.
Aluminiowa rączka Formuła.



Deep tray or tray Plus – large, two level handy tray with a comfortable handle.

Głęboka jedno- lub dwupoziomowa tacka Plus - duża dwupoziomowa, poręczna tacka z wygodną rączką.



Formula organizer – it allows you to separate small accessories, in this way, you can find the elements you need quickly.

Organizer Formuła - umożliwia posegregowanie drobnych akcesoriów, dzięki czemu zdecydowanie szybciej można odszukać potrzebne elementy.



Padlock hole – special padlock hole in the box can be used to protect your tools against theft.

Miejsce na kłódkę specjalnie wykonany otwór w skrzynce, umożliwia zabezpieczenie magazynowanych narzędzi przed kradzieżą.



Side handles – help you to carry Tool-Box filled with heavy tools.

Uchwyty boczne - ułatwiają przenoszenie wypełnionej ciężkimi narzędziami skrzynki.



Portable workshop – thanks to specially made handle, you can transform your box into a mini tool table.

Mini warsztat - dzięki specjalnie wykonanemu uchwytowi, możliwa jest przemiana skrzynki w mini stół narzędziowy.



Alu latches – made of anodized aluminium.

Zapięcia Alu - wykonane z anodowanego aluminium.

*tools not included/nie zawiera narzędzi

Toolbox Formula S 500

Skrzynka narzędziowa Formuła S 500

Product info

informacje o produkcie

462 [L] x 256 [W] x 242 [H] mm 450 [L] x 230 [W] x 170 [H] mm

Colour	Index	EAN		
	SKRS500FRCCZAPG001	5901238242697	56	7

Organizer scheme
Rozkład organizera



Optional: Two level tray
Opcjonalnie: Dwupoziomowa tacka

Formula Alu handle
Aluminiowa rączka Formuła

Deep tray organizer with sockets and bits storage
Głęboka tacka z otworami na nasadki i bity

Side handles
Uchwyty boczne

Padlock hole
Miejsce na kłódkę

Portable workshop
Mini warsztat



Toolbox Formula S 600

Skrzynka narzędziowa Formuła S 600

Product info

informacje o produkcie

547 [L] x 271 [W] x 278 [H] mm 530 [L] x 250 [W] x 185 [H] mm

Colour	Index	EAN		
	SKRS600FRCCZAPG001	5901238242703	42	6

Organizer scheme
Rozkład organizera



Optional: Two level tray
Opcjonalnie: Dwupoziomowa tacka

Formula Alu handle
Aluminiowa rączka Formuła

Deep tray organizer with sockets and bits storage
Głęboka tacka z otworami na nasadki i bity

Side handles
Uchwyty boczne

Padlock hole
Miejsce na kłódkę

Portable workshop
Mini warsztat



Toolbox Formula S 700

Skrzynka narzędziowa Formuła S 700

Product info

informacje o produkcie

595 [L] x 289 [W] x 328 [H] mm 580 [L] x 270 [W] x 210 [H] mm

Colour	Index	EAN		
	SKRS700FCAFCZAPG001	5901238242529	36	6

Organizer scheme
Rozkład organizera



Optional: Two level tray
Opcjonalnie: Dwupoziomowa tacka

Formula Alu handle
Aluminiowa rączka Formuła

Deep tray organizer with sockets and bits storage
Głęboka tacka z otworami na nasadki i bity

Side handles
Uchwyty boczne

Padlock hole
Miejsce na kłódkę

Portable workshop
Mini warsztat





Legenda
Caption

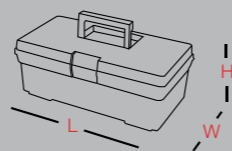

Toolboxes FORMULA | A

Skrzynki narzędziowe Formuła A

Available colours
Dostępne kolory



Deep tray – with a comfortable handle. Small storage containers fit in its compartments perfectly, which facilitates the arrangement of accessories such as screws and nuts.

Głęboka tacka - z wygodną rączką. Do przegród, w które jest wyposażona, idealnie pasują niewielkie pojemniki magazynowe, ułatwiające posegregowanie akcesoriów takich jak śrubki, czy nakrętki.



Transparent cover – helps to find quickly necessary elements.

Transparentna pokrywa - umożliwia bardzo szybkie odwołanie potrzebnych elementów.



Tray organizer with sockets and bits storage.

Tacka z otworami na nasadki i bity.



Solid plastic latches.

Solidne plastikowe zapięcia.



Basic handle – one-compartment handle, allowing for comfortable transport of the box.

Rączka Basic - prosty, jednokomorowy uchwyt, dzięki któremu można wygodnie przenosić skrzynkę.



*tools not included/ nie zawiera narzędzi

Toolbox Formula A300

Skrzynka narzędziowa Formuła A300

Product info
informacje o produkcie

374 [L] x 198 [W] x 189 [H] mm 320 [L] x 150 [W] x 145 [H] mm

Colour	Index	EAN		
	SKRA300FCZAPG001	5901238221289	140	14

Organizer scheme
Rozkład organizera

Deep tray organizer with sockets and bits storage
Głęboka tacka z otworami na nasadki i bity

Side handles
Uchwyty boczne

Padlock hole
Miejsce na klódkę



Toolbox Formula A500

Skrzynka narzędziowa Formuła A500

Product info
informacje o produkcie

462 [L] x 256 [W] x 242 [H] mm 450 [L] x 230 [W] x 170 [H] mm

Colour	Index	EAN		
	SKRA500FCZAPG001	5901238209195	56	7

Organizer scheme
Rozkład organizera

Deep tray organizer with sockets and bits storage
Głęboka tacka z otworami na nasadki i bity

Side handles
Uchwyty boczne

Padlock hole
Miejsce na klódkę



Toolbox Formula A600

Skrzynka narzędziowa Formuła A600

Product info
informacje o produkcie

547 [L] x 271 [W] x 278 [H] mm 530 [L] x 250 [W] x 185 [H] mm

Colour	Index	EAN		
	SKRA600FCZAPG001	5901238209201	42	6

Organizer scheme
Rozkład organizera

Deep tray organizer with sockets and bits storage
Głęboka tacka z otworami na nasadki i bity

Side handles
Uchwyty boczne

Padlock hole
Miejsce na klódkę



Toolbox Formula A700

Skrzynka narzędziowa Formuła A700

Product info
informacje o produkcie

595 [L] x 289 [W] x 328 [H] mm 580 [L] x 270 [W] x 210 [H] mm

Colour	Index	EAN		
	SKRA700FCZAPG001	5901238209218	36	6

Organizer scheme
Rozkład organizera

Deep tray organizer with sockets and bits storage
Głęboka tacka z otworami na nasadki i bity

Side handles
Uchwyty boczne

Padlock hole
Miejsce na klódkę





Toolboxes STUFF

Skrzynki narzędziowe Stuff

Modern look and solid manufacture are the main features of Patrol Group's Stuff line of toolboxes. Extra ribs composed in cover significantly increase their durability. Each toolbox possess large and handy tray with a comfortable handle. Small storage containers fit in its compartments perfectly, which facilitates the arrangement of accessories such as screws and nuts. Specially designed latches position themselves to prevent improper locking.

Linia skrzynek Stuff to nowoczesność oraz solidne wykonanie. Dodatkowe żebra znajdujące się w pokrywach znacząco podwyższają ich wytrzymałość. Każda ze skrzynek posiada tackę z przestronnymi komorami oraz miejscem na bity, a specjalnie zaprojektowane zapięcia pozycjonują się, zapobiegając nieprawidłowemu zamknięciu.

Legenda
Caption

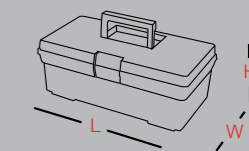

Toolboxes STUFF CARBO

Skrzynki narzędziowe Stuff Carbo

Available colours
Dostępne kolory



Aluminium latches
Aluminiowe zapięcia



Super strong covers
Super wytrzymałe pokrywy



Padlock hole
Miejsce na kłódkę



Adjustable dividers
Regulowane przegrody









Toolbox Stuff Semi Profi 12 Carbo

Skrzynka narzędziowa Stuff Semi Profi 12 Carbo

Product info

informacje o produkcie

312 [L] x 167 [W] x 130 [H] mm 305 [L] x 150 [W] x 100 [H] mm

Colour	Index	EAN		
	SKR12SPSCARZOLPG001	5901238233121	300	20
	SKR12SPSCARCZEPG001	5901238242543	300	20
	SKR12SPSCARCZAPG001	5901238242628	300	20
	SKR12SPSCARPOMPG001	5901238242574	300	20
	SKR12SPSCARNIEPG001	5901238242581	300	20

Available colours

Dostępne kolory

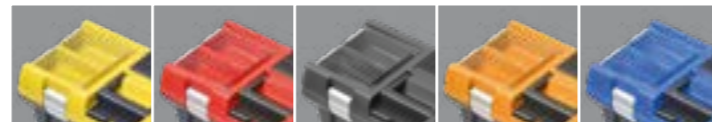

Stuff handle
Rączka Stuff

Stuff latches
Zapięcia Stuff

Deep tray organizer with sockets and bits storage
Głęboka tacka z otworami na nasadki i bity

Side handles
Uchwyty boczne

2 Stuff organizers
2 Organizery Stuff





Toolbox Stuff Semi Profi 20 Carbo

Skrzynka narzędziowa Stuff Semi Profi 20 Carbo

Product info

informacje o produkcie

525 [L] x 256 [W] x 246 [H] mm 510 [L] x 235 [W] x 190 [H] mm

Colour	Index	EAN		
	SKR20SPSCARZOLPG001	5901238233145	56	7
	SKR20SPSCARCZEPG001	5901238242550	56	7
	SKR20SPSCARCZAPG001	5901238242642	56	7
	SKR20SPSCARPOMPG001	5901238238201	56	7
	SKR20SPSCARNIEPG001	5901238242604	56	7

Available colours

Dostępne kolory

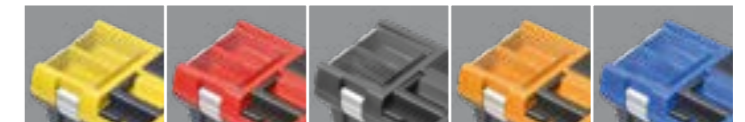

Stuff handle
Rączka Stuff

Stuff latches
Zapięcia Stuff

Deep tray organizer with sockets and bits storage
Głęboka tacka z otworami na nasadki i bity

Padlock hole
Miejsce na klódkę

Side handles
Uchwyty boczne

4 Stuff organizers
4 Organizery Stuff









Toolbox Stuff Semi Profi 16 Carbo

Skrzynka narzędziowa Stuff Semi Profi 16 Carbo

Product info

informacje o produkcie

415 [L] x 226 [W] x 200 [H] mm 405 [L] x 205 [W] x 145 [H] mm

Colour	Index	EAN		
	SKR16SPSCARZOLPG001	5901238233138	120	12
	SKR16SPSCARCZEPG001	5901238233893	120	12
	SKR16SPSCARCZAPG001	5901238242635	120	12
	SKR16SPSCARPOMPG001	5901238238195	120	12
	SKR16SPSCARNIEPG001	5901238242598	120	12

Available colours

Dostępne kolory

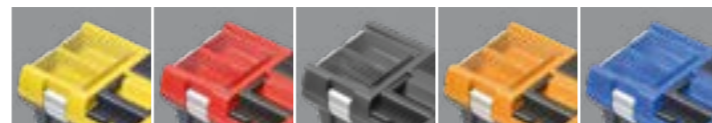

Stuff handle
Rączka Stuff

Stuff latches
Zapięcia Stuff

Deep tray organizer with sockets and bits storage
Głęboka tacka z otworami na nasadki i bity

Padlock hole
Miejsce na klódkę

Side handles
Uchwyty boczne

2 Stuff organizers
2 Organizery Stuff









Toolbox Stuff Semi Profi 26 Carbo

Skrzynka narzędziowa Stuff Semi Profi 26 Carbo

Product info

informacje o produkcie

595 [L] x 337 [W] x 316 [H] mm 580 [L] x 315 [W] x 245 [H] mm

Colour	Index	EAN		
	SKR26SPSCARZOLPG001	5901238233152	24	4
	SKR26SPSCARCZEPG001	5901238242567	24	4
	SKR26SPSCARCZAPG001	5901238242659	24	4
	SKR26SPSCARPOMPG001	5901238238218	24	4
	SKR26SPSCARNIEPG001	5901238242611	24	4

Available colours

Dostępne kolory

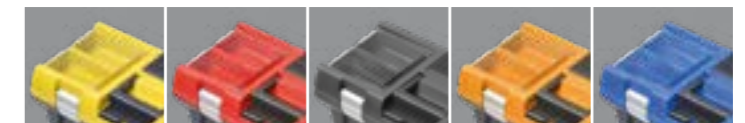

Stuff handle
Rączka Stuff

Stuff latches
Zapięcia Stuff

Deep tray organizer with sockets and bits storage
Głęboka tacka z otworami na nasadki i bity

Padlock hole
Miejsce na klódkę

Side handles
Uchwyty boczne

6 Stuff organizers
6 Organizery Stuff



Toolboxes

STUFF MODULE SYSTEM CARBO

Skrzynki narzędziowe Stuff Module System Carbo

Available colours 
Dostępne kolory



Ergobox 2 Plus x3

Ergobox Plus is a multi-purpose containers, which in combination with the box STUFF is the perfect modul for storing tools and workshop accessories.

ErgoBox Plus to wielofunkcyjne pojemniki, które w połączeniu ze skrzynką STUFF tworzą idealny modul do przechowywania narzędzi i akcesoriów warsztatowych.

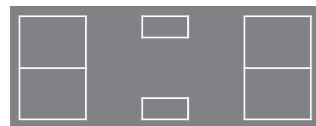

Stuff organizers – allow to storage and ensure easy access to small elements.

Organizery Stuff – pozwalają na magazynowanie i łatwy dostęp do drobnych elementów.

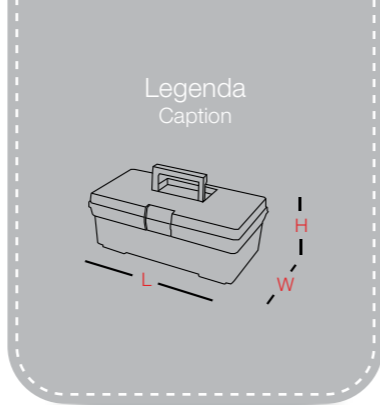

Legenda
Caption

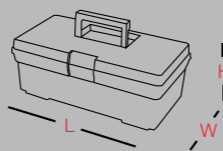







Toolbox Stuff Module System Carbo

Skrzynka narzędziowa Stuff Module System Carbo

Product info

informacje o produkcie

 525 [L] x 256 [W] x 325 [H] mm  510 [L] x 235 [W] x 190 [H] mm

Colour	Index	EAN		
	SKR20SPSMSGAZOLPG001	5901238242406	42	7
	SKR20SPSMSCACZEPG001	5901238242673	42	7
	SKR20SPSMSCACZAPG001	5901238242666	42	7
	SKR20SPSMSCAOPMPG001	5901238239918	42	7
	SKR20SPSMSCANIEPG001	5901238242680	42	7



Organizer scheme
Rozkład organizera

- Stuff handle
Rączka Stuff
- Stuff latches
Zapięcia Stuff
- Deep tray organizer with sockets and bits storage
Głęboka taca z otworami na nasadki i bity
- Padlock hole
Miejsce na kłódkę
- Side handles
Uchwyty boczne
- 6 Stuff organizers
6 Organizery Stuff
- 3x Ergobox Plus
3x Ergobox Plus



Available colours
Dostępne kolory

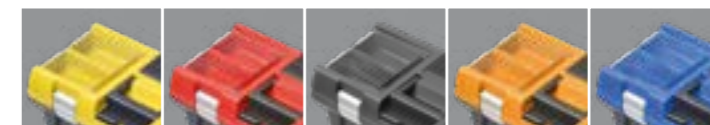

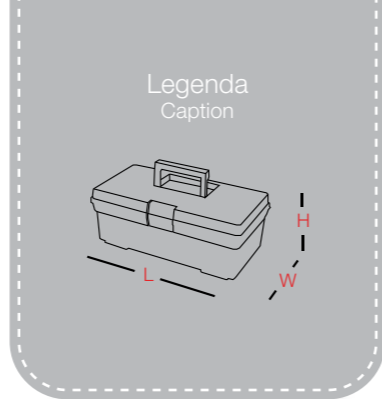

Toolboxes STUFF

Skrzynki narzędziowe Stuff

Available colors
Dostępne kolory ●



Deep tray with a comfortable handle. Small storage containers fit in its compartments perfectly, which facilitates the arrangement of accessories such as screws and nuts.

Głęboka tacka z wygodną rączką. Do przegród, w które jest wyposażona, idealnie pasują niewielkie pojemniki magazynowe, ułatwiające posegregowanie akcesoriów takich jak śrubki, czy nakrętki.



Padlock hole – special hole in the box can be used to protect your tools against theft.

Miejsce na kłódkę – specjalnie wykonany otwór w skrzynce, umożliwia zabezpieczenie magazynowanych narzędzi.



Reinforced pins – made of durable plastic prevent breakage of the hinges.

Wzmocnione trzpienie – wykonane z wytrzymałego tworzywa zapobiegają uszkodzeniu zawiasów.



Stuff latches - specially designed, position themselves to prevent improper locking.

Zapięcia Stuff - specjalnie zaprojektowane, pozycjonują się zapobiegając nieprawidłowemu zamknięciu.



Stuff Alu latches - specially designed, position themselves to prevent improper locking.

Zapięcia Stuff Alu - specjalnie zaprojektowane, pozycjonują się zapobiegając nieprawidłowemu zamknięciu.



6 organizers on the cover of Stuff 26 Semi Profi
6 organizerów w pokrywie Stuff 26 Semi Profi

Adjustable compartments
Regulowane przegrody



Space saving packing
Ekonomiczne pakowanie



Stuff handle – ensures comfortable and safe grip during carriage.

Rączka Stuff – zapewnia komfortowy i pewny chwyt podczas noszenia.



Side handles – help you to carry boxes filled with heavy tools.

Uchwyty boczne – ułatwiają przenoszenie wypełnionej ciężkimi narzędziami skrzynki.



Reinforced ribs - composed in cover significantly increase box durability.

Żebra wzmacniające – znajdujące się w pokrywach znacząco podwyższają wytrzymałość skrzynki.



Stuff Organizers – allow to storage and ensure easy access to small elements.

Organizery Stuff – pozwalają na magazynowanie i łatwy dostęp do drobnych elementów.

*tools not included/nie zawiera narzędzi

Toolbox Stuff 12 Optimo B

Skrzynka narzędziowa Stuff 12 Optimo B

Product info

informacje o produkcie

312 [L] x 167 [W] x 130 [H] mm 305 [L] x 150 [W] x 100 [H] mm

Colour	Index	EAN		
	SKR12BSTUOCZAPG001	5901238244172	300	20

Stuff handle
Rączka Stuff

Stuff latches
Zapięcia Stuff

Side handles
Uchwyty boczne



Toolbox Stuff 20 Optimo B

Skrzynka narzędziowa Stuff 20 Optimo B

Product info

informacje o produkcie

525 [L] x 256 [W] x 246 [H] mm 510 [L] x 235 [W] x 190 [H] mm

Colour	Index	EAN		
	SKR20BSTUOCZAPG001	5901238244110	56	7

Stuff handle
Rączka Stuff

Stuff latches
Zapięcia Stuff

Tray
Pół-tacka

Padlock hole
Miejsce na kłódkę

Side handles
Uchwyty boczne



Toolbox Stuff 16 Optimo B

Skrzynka narzędziowa Stuff 16 Optimo B

Product info

informacje o produkcie

415 [L] x 226 [W] x 200 [H] mm 405 [L] x 205 [W] x 145 [H] mm

Colour	Index	EAN		
	SKR16BSTUOCZAPG001	5901238244127	120	12

Stuff handle
Rączka Stuff

Stuff latches
Zapięcia Stuff

Tray
Pół-tacka

Padlock hole
Miejsce na kłódkę

Side handles
Uchwyty boczne



Toolbox Stuff 26 Optimo B

Skrzynka narzędziowa Stuff 26 Optimo B

Product info

informacje o produkcie

595 [L] x 337 [W] x 316 [H] mm 580 [L] x 315 [W] x 245 [H] mm

Colour	Index	EAN		
	SKR26BSTUOCZAPG001	5901238244134	24	4

Stuff handle
Rączka Stuff

Stuff latches
Zapięcia Stuff

Tray
Pół-tacka

Padlock hole
Miejsce na kłódkę

Side handles
Uchwyty boczne



Toolbox Stuff Basic 12

Skrzynka narzędziowa Stuff Basic 12

Product info

informacje o produkcie

312 [L] x 167 [W] x 130 [H] mm 305 [L] x 150 [W] x 100 [H] mm

Colour	Index	EAN		
	SKR12BSTUFFCZAPG001	5901238215219	300	20

Stuff handle
Rączka Stuff

Stuff latches
Zapięcia Stuff

Deep tray organizer with sockets and bits storage
Głęboka tacka z otworami na nasadki i bity

Side handles
Uchwyty boczne



Toolbox Stuff Basic 20

Skrzynka narzędziowa Stuff Basic 20

Product info

informacje o produkcie

525 [L] x 256 [W] x 225 [H] mm 510 [L] x 235 [W] x 190 [H] mm

Colour	Index	EAN		
	SKR20BSTUFFCZAPG001	5901238214519	56	7

Stuff handle
Rączka Stuff

Stuff latches
Zapięcia Stuff

Deep tray organizer with sockets and bits storage
Głęboka tacka z otworami na nasadki i bity

Padlock hole
Miejsce na kłódkę

Side handles
Uchwyty boczne



Toolbox Stuff Basic 16

Skrzynka narzędziowa Stuff Basic 16

Product info

informacje o produkcie

415 [L] x 226 [W] x 181 [H] mm 405 [L] x 205 [W] x 145 [H] mm

Colour	Index	EAN		
	SKR16BSTUFFCZAPG001	5901238215226	120	12

Stuff handle
Rączka Stuff

Stuff latches
Zapięcia Stuff

Deep tray organizer with sockets and bits storage
Głęboka tacka z otworami na nasadki i bity

Padlock hole
Miejsce na kłódkę

Side handles
Uchwyty boczne





Toolbox Stuff Basic 26

Skrzynka narzędziowa Stuff Basic 26

Product info

informacje o produkcie

595 [L] x 337 [W] x 316 [H] mm 580 [L] x 315 [W] x 245 [H] mm

Colour	Index	EAN		
	SKR26BSTUFFCZAPG001	5901238215233	24	4

Stuff handle
Rączka Stuff

Stuff latches
Zapięcia Stuff

Deep tray organizer with sockets and bits storage
Głęboka tacka z otworami na nasadki i bity

Padlock hole
Miejsce na kłódkę

Side handles
Uchwyty boczne





Toolbox Stuff 12 Optimo SP

Skrzynka narzędziowa Stuff 12 Optimo SP

Product info

informacje o produkcie

312 [L] x 167 [W] x 130 [H] mm 305 [L] x 150 [W] x 100 [H] mm

Colour	Index	EAN		
	SKR12SPSTUOCZAPG001	5901238244189	300	20



Stuff handle
Rączka Stuff

Stuff latches
Zapięcia Stuff

Side handles
Uchwyty boczne

2 Stuff organizers
2 Organizery Stuff





Toolbox Stuff 20 Optimo SP

Skrzynka narzędziowa Stuff 20 Optimo SP

Product info

informacje o produkcie

525 [L] x 256 [W] x 246 [H] mm 510 [L] x 235 [W] x 190 [H] mm

Colour	Index	EAN		
	SKR20SPSTUOCZAPG001	5901238244066	56	7



Stuff handle
Rączka Stuff

Stuff latches
Zapięcia Stuff

Tray
Pół-tacka

Padlock hole
Miejsce na klódkę

Side handles
Uchwyty boczne

4 Stuff organizers
4 Organizery Stuff



Toolbox Stuff 16 Optimo SP

Skrzynka narzędziowa Stuff 16 Optimo SP

Product info

informacje o produkcie

415 [L] x 226 [W] x 200 [H] mm 405 [L] x 205 [W] x 145 [H] mm

Colour	Index	EAN		
	SKR16SPSTUOCZAPG001	5901238244073	120	12



Stuff handle
Rączka Stuff

Stuff latches
Zapięcia Stuff

Tray
Pół-tacka

Padlock hole
Miejsce na klódkę

Side handles
Uchwyty boczne

2 Stuff organizers
2 Organizery Stuff





Toolbox Stuff 26 Optimo SP

Skrzynka narzędziowa Stuff 26 Optimo SP

Product info

informacje o produkcie

595 [L] x 337 [W] x 316 [H] mm 580 [L] x 315 [W] x 245 [H] mm

Colour	Index	EAN		
	SKR26SPSTUOCZAPG001	5901238244103	24	4



Stuff handle
Rączka Stuff

Stuff latches
Zapięcia Stuff

Tray
Pół-tacka

Padlock hole
Miejsce na klódkę

Side handles
Uchwyty boczne

6 Stuff organizers
6 Organizery Stuff



Toolbox Stuff Semi Profi 12

Skrzynka narzędziowa Stuff Semi Profi 12

Product info

informacje o produkcie

312 [L] x 167 [W] x 130 [H] mm 305 [L] x 150 [W] x 100 [H] mm

Colour	Index	EAN		
	SKR12SPSTUFFCZAPG001	5901238215189	300	20

 **Organizer scheme**
Rozkład organizera

- Stuff handle
Rączka Stuff
- Stuff latches
Zapięcia Stuff
- Deep tray organizer with sockets and bits storage
Głęboka tacka z otworami na nasadki i bity
- Side handles
Uchwyty boczne
- 2 Stuff organizers
2 Organizery Stuff



Toolbox Stuff Semi Profi 20

Skrzynka narzędziowa Stuff Semi Profi 20

Product info

informacje o produkcie

525 [L] x 256 [W] x 246 [H] mm 510 [L] x 235 [W] x 190 [H] mm

Colour	Index	EAN		
	SKR20SPSTUFFCZAPG001	5901238214618	56	7

 **Organizer scheme**
Rozkład organizera

- Stuff handle
Rączka Stuff
- Stuff latches
Zapięcia Stuff
- Deep tray organizer with sockets and bits storage
Głęboka tacka z otworami na nasadki i bity
- Side handles
Uchwyty boczne
- 4 Stuff organizers
4 Organizery Stuff



Toolbox Stuff Semi Profi 16

Skrzynka narzędziowa Stuff Semi Profi 16

Product info

informacje o produkcie

415 [L] x 226 [W] x 200 [H] mm 405 [L] x 205 [W] x 145 [H] mm

Colour	Index	EAN		
	SKR16SPSTUFFCZAPG001	5901238215196	120	12

 **Organizer scheme**
Rozkład organizera

- Stuff handle
Rączka Stuff
- Stuff latches
Zapięcia Stuff
- Deep tray organizer with sockets and bits storage
Głęboka tacka z otworami na nasadki i bity
- Side handles
Uchwyty boczne
- 2 Stuff organizers
2 Organizery Stuff



Toolbox Stuff Semi Profi 26

Skrzynka narzędziowa Stuff Semi Profi 26

Product info

informacje o produkcie

595 [L] x 337 [W] x 316 [H] mm 580 [L] x 315 [W] x 245 [H] mm

Colour	Index	EAN		
	SKR26SPSTUFFCZAPG001	5901238215202	24	4

 **Organizer scheme**
Rozkład organizera

- Stuff handle
Rączka Stuff
- Stuff latches
Zapięcia Stuff
- Deep tray organizer with sockets and bits storage
Głęboka tacka z otworami na nasadki i bity
- Side handles
Uchwyty boczne
- 6 Stuff organizers
6 Organizery Stuff



Toolbox Stuff Basic Alu 16

Skrzynka narzędziowa Stuff Basic Alu 16

Product info

informacje o produkcie

415 [L] x 226 [W] x 200 [H] mm 405 [L] x 205 [W] x 145 [H] mm

Colour	Index	EAN		
	SKR16BALSTUCZAPG001	5901238221500	120	12

- Stuff handle
Rączka Stuff
- Stuff Alu latches
Zapięcia Stuff Alu
- Deep tray organizer with sockets and bits storage
Głęboka tacka z otworami na nasadki i bity
- Padlock hole
Miejsce na klódkę
- Side handles
Uchwyty boczne



Toolbox Stuff Basic Alu 26

Skrzynka narzędziowa Stuff Basic Alu 26

Product info

informacje o produkcie

595 [L] x 337 [W] x 316 [H] mm 580 [L] x 315 [W] x 245 [H] mm

Colour	Index	EAN		
	SKR26BALSTUCZAPG001	5901238221524	24	4

- Stuff handle
Rączka Stuff
- Stuff latches
Zapięcia Stuff
- Deep tray organizer with sockets and bits storage
Głęboka tacka z otworami na nasadki i bity
- Side handles
Uchwyty boczne
- 4 Stuff organizers
4 Organizery Stuff



Toolbox Stuff Basic Alu 20

Skrzynka narzędziowa Stuff Basic Alu 20

Product info

informacje o produkcie

525 [L] x 256 [W] x 246 [H] mm 510 [L] x 235 [W] x 190 [H] mm

Colour	Index	EAN		
	SKR20BALSTUCZAPG001	5901238221517	56	7

- Stuff handle
Rączka Stuff
- Stuff latches
Zapięcia Stuff
- Deep tray organizer with sockets and bits storage
Głęboka tacka z otworami na nasadki i bity
- Side handles
Uchwyty boczne
- 2 Stuff organizers
2 Organizery Stuff



Toolbox Stuff Semi Profi Alu 16

Skrzynka narzędziowa Stuff Semi Profi Alu 16

Product info

informacje o produkcie

415 [L] x 226 [W] x 200 [H] mm 405 [L] x 205 [W] x 145 [H] mm

Colour	Index	EAN		
	SKR16SPALSTUCZAPG001	5901238221548	120	12



Stuff handle
Rączka Stuff

Stuff Alu latches
Zapięcia Stuff Alu

Deep tray organizer with sockets and bits storage
Głęboka tacka z otworami na nasadki i bity

Padlock hole
Miejsce na kłódkę

Side handles
Uchwyty boczne

2 Stuff organizers
2 Organizery Stuff



Toolbox Stuff Semi Profi Alu 26

Skrzynka narzędziowa Stuff Semi Profi Alu 26

Product info

informacje o produkcie

595 [L] x 337 [W] x 316 [H] mm 580 [L] x 315 [W] x 245 [H] mm

Colour	Index	EAN		
	SKR26SPALSTUCZAPG001	5901238221562	24	4



Stuff handle
Rączka Stuff

Stuff Alu latches
Zapięcia Stuff Alu

Deep tray organizer with sockets and bits storage
Głęboka tacka z otworami na nasadki i bity

Padlock hole
Miejsce na kłódkę

Side handles
Uchwyty boczne

6 Stuff organizers
6 Organizery Stuff



Toolbox Stuff Semi Profi Alu 20

Skrzynka narzędziowa Stuff Semi Profi Alu 20

Product info

informacje o produkcie

525 [L] x 256 [W] x 246 [H] mm 510 [L] x 235 [W] x 190 [H] mm

Colour	Index	EAN		
	SKR20SPALSTUCZAPG001	5901238221555	56	7



Stuff handle
Rączka Stuff

Stuff Alu latches
Zapięcia Stuff Alu

Deep tray organizer with sockets and bits storage
Głęboka tacka z otworami na nasadki i bity

Padlock hole
Miejsce na kłódkę

Side handles
Uchwyty boczne

4 Stuff organizers
4 Organizery Stuff



Toolbox Stuff 16 Optimo P

Skrzynka narzędziowa Stuff 16 Optimo P

Product info

informacje o produkcie

415 [L] x 226 [W] x 181 [H] mm 405 [L] x 205 [W] x 145 [H] mm

Colour	Index	EAN		
	SKR16PSTUOCZAPG001	5901238243014	132	12

Stuff handle
Rączka Stuff

Stuff Alu latches
Zapięcia Stuff Alu

Tray
Półtacka

Padlock hole
Miejsce na kłódkę

Side handles
Uchwyty boczne

2 Stuff organizers
2 Organizery Stuff



Toolbox Stuff 20 Optimo P

Skrzynka narzędziowa Stuff 20 Optimo P

Product info

informacje o produkcie

525 [L] x 256 [W] x 225 [H] mm 510 [L] x 235 [W] x 190 [H] mm

Colour	Index	EAN		
	SKR20PSTUOCZAPG001	5901238243021	63	7

Stuff handle
Rączka Stuff

Stuff Alu latches
Zapięcia Stuff Alu

Tray
Półtacka

Padlock hole
Miejsce na kłódkę

Side handles
Uchwyty boczne

4 Stuff organizers
4 Organizery Stuff





STUFF Module System

Skrzynki Narzędziowe
Stuff Module System

Available colors
Dostępne kolory



STUFF MODULE SYSTEM is an innovative combination of the functionality of the solid tool box with the advantages of a modern system of containers ErgoBox. The modular design of this model ensures the highest ergonomics and the ability to store different tools. All cases in this line are equipped with a deep tray, strong latches and reinforcement - Semi Profi version is enriched with four organizers.

STUFF MODULE SYSTEM to nowatorskie połączenie funkcjonalności solidnej skrzynki narzędziowej z zaletami nowoczesnego systemu pojemników ErgoBox. Modułowa budowa tego modelu gwarantuje najwyższą ergonomię pracy oraz możliwość przechowywania zróżnicowanych narzędzi. Wszystkie skrzynki z tej linii są wyposażone w głębokie tacki, mocne zapięcia oraz wzmocnioną konstrukcję - wersja Semi Profi jest wzbogacona o cztery organizery.



Stuff organizers – allow storing and ensure easy access to small elements.

Organizery Stuff – pozwalają na magazynowanie i łatwy dostęp do drobnych elementów.



Ergobox 2 Plus x3

Ergobox Plus is a multi-purpose containers, which in combination with the box STUFF is the perfect modul for storing tools and workshop accessories.

ErgoBox Plus to wielofunkcyjne pojemniki, które w połączeniu ze skrzynką STUFF tworzą idealny modul do przechowywania narzędzi i akcesoriów warsztatowych.



ErgoBox 2 Plus use also with:
ErgoBox 2 Plus używaj również z:



*tools not included/nie zawiera narzędzi



Stuff Module System Basic

Skrzynka narzędziowa Stuff Module System Basic

Product info

informacje o produkcie

525 [L] x 256 [W] x 325 [H] mm 510 [L] x 235 [W] x 190 [H] mm

Colour	Index	EAN		
	SKR20BSMSCZAPG001	5901238223108	42	7

Stuff handle
Rączka Stuff

Stuff latches
Zapięcia Stuff

Deep tray organizer with sockets and bits storage
Głęboka tacka z otworami na nasadki i bity

Padlock hole
Miejsce na klódkę

Side handles
Uchwyty boczne



Stuff Module System Semi Profi

Skrzynka narzędziowa Stuff Module System Semi Profi

Product info

informacje o produkcie

525 [L] x 256 [W] x 325 [H] mm 510 [L] x 235 [W] x 190 [H] mm

Colour	Index	EAN		
	SKR20SPSMSCZAPG001	5901238223115	42	7

Stuff handle
Rączka Stuff

Stuff latches
Zapięcia Stuff

Deep tray organizer with sockets and bits storage
Głęboka tacka z otworami na nasadki i bity

Padlock hole
Miejsce na klódkę

Side handles
Uchwyty boczne

2 Stuff organizers
2 Organizery Stuff





Stuff Module System Basic Alu

Skrzynka narzędziowa Stuff Module System Basic Alu

Product info

informacje o produkcie

525 [L] x 256 [W] x 325 [H] mm 510 [L] x 235 [W] x 190 [H] mm

Colour	Index	EAN		
	SKR20BSMSALCZAPG001	5901238224566	42	7

Stuff handle
Rączka Stuff

Stuff latches Alu
Zapięcia Stuff Alu

Deep tray organizer with sockets and bits storage
Głęboka tacka z otworami na nasadki i bity

Padlock hole
Miejsce na klódkę

Side handles
Uchwyty boczne



Stuff Module System Semi Profi Alu

Skrzynka narzędziowa Stuff Module System Semi Profi Alu

Product info

informacje o produkcie

525 [L] x 256 [W] x 325 [H] mm 510 [L] x 235 [W] x 190 [H] mm

Colour	Index	EAN		
	SKR20SPSMSALCZAPG001	5901238224563	42	7

Stuff handle
Rączka Stuff

Stuff latches Alu
Zapięcia Stuff Alu

Deep tray organizer with sockets and bits storage
Głęboka tacka z otworami na nasadki i bity

Padlock hole
Miejsce na klódkę

Side handles
Uchwyty boczne

2 Stuff organizers
2 Organizery Stuff



Stuff Module System Optimo B

Skrzynka narzędziowa Stuff Module System Optimo B

Product info

informacje o produkcie

525 [L] x 256 [W] x 325 [H] mm 510 [L] x 235 [W] x 190 [H] mm

Colour	Index	EAN		
	SKR20BSMSOCZAPG001	5901238244240	42	7

- Stuff handle
Rączka Stuff
- Stuff latches
Zapięcia Stuff
- Tray
Półtacka
- Padlock hole
Miejsce na klódkę
- Side handles
Uchwyty boczne



Stuff Module System Optimo SP

Skrzynka narzędziowa Stuff Module System Optimo SP

Product info

informacje o produkcie

525 [L] x 337 [W] x 325 [H] mm 510 [L] x 235 [W] x 190 [H] mm

Colour	Index	EAN		
	SKR20SPSMSOCZAPG001	5901238244264	42	7

- Stuff handle
Rączka Stuff
- Stuff latches
Zapięcia Stuff
- Tray
Półtacka
- Padlock hole
Miejsce na klódkę
- Side handles
Uchwyty boczne
- 3x Ergobox 2 Plus
3x Ergobox 2 Plus



Organizer scheme
Rozkład organizera



Stuff Module System Optimo P

Skrzynka narzędziowa Stuff Module System Optimo P

Product info

informacje o produkcie

525 [L] x 256 [W] x 305 [H] mm 510 [L] x 235 [W] x 190 [H] mm

Colour	Index	EAN		
	SKR20PSMSOCZAPG001	5901238244257	42	7

- Stuff handle
Rączka Stuff
- Stuff latches Alu
Zapięcia Stuff Alu
- Deep tray organizer with sockets and bits storage
Głęboka tacka z otworami na nasadki i bity
- Padlock hole
Miejsce na klódkę
- Side handles
Uchwyty boczne
- 2 Stuff organizers
2 Organizery Stuff





Wheelbox STUFF

Skrzynka narzędziowa
Stuff WheelBox

Available colors
Dostępne kolory



Stuff Wheelbox is a modern, capacious and mobile toolbox. Specially designed cover received additional ribs, which significantly increases its durability. Telescopic handle with ability to adjust its length allows to adapt it to the height of the user. Plastic wheels are additionally protected with rubber layer, which makes them more resistant to mechanical damage as well as prevent the slipping on the ground.

Stuff Wheelbox to nowoczesna, pojemna i mobilna skrzynka narzędziowa. Specjalnie zaprojektowana pokrywa otrzymała dodatkowe ożebrowanie, które znacząco zwiększa jej trwałość. Teleskopowa rączka posiada możliwość regulacji długości, co pozwala dostosować ją do wzrostu użytkownika. Plastikowe koła są dodatkowo zabezpieczone warstwą gumy, co sprawia, że są bardziej odporne na uszkodzenia mechaniczne, jak również zapobiegają ślizganiu się po podłożu.



Telescopic Handle
Teleskopowa Rączka



Don't lift the toolbox with this handle
Nie podnoś skrzynki za rączkę



Plastic wheels – the rubber layer protects them from mechanical defects.

Plastikowe kółka – zabezpieczone warstwą gumy zapewniają odporność na uszkodzenia mechaniczne.

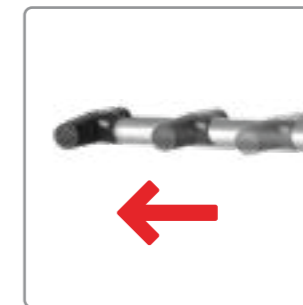

Telescopic handle – allows you to adjust the handle to desired length.

Rączka teleskopowa z możliwością regulacji jego długości.

Wheelbox Stuff Alu Basic 26

Skrzynka narzędziowa Wheelbox Stuff Alu Basic 26

Product info

informacje o produkcie

760 [L] x 380 [W] x 330 [H] mm	580 [L] x 315 [W] x 245 [H] mm
--------------------------------	--------------------------------

Colour	Index	EAN		
	SKRW26BALSCZAPG001	5901238221739	18	3

Plastic wheels with rubber layer
Kółka z plastiku zabezpieczone warstwą gumy

Telescopic handle
Teleskopowa rączka

Stuff handle
Rączka Stuff

Alu Stuff latches
Zapięcia Stuff Alu

Padlock hole
Miejsce na kłódkę

Side handles
Uchwyty boczne



*tools not included/ nie zawiera narzędzi

POWERTOOL CASE

Skrzynka narzędziowa
na narzędzia elektryczne

Practical and sturdy powertool cases guarantee safety for your precious powertools. The inside of the toolcase is lined with elastic sponge that keeps your tool from moving around while being transported. Powertool cases can store tools of varied sizes. They are perfect for drills, drill-drivers, angle grinders, jigsaw and other tools. Cases keep your tools safe from damage and dirt during transportation. Ergonomic latches can hold some serious weight.

Praktyczne i wytrzymałe walizki na elektronarzędzia są gwarancją bezpieczeństwa dla elektronarzędzi. Wnętrze pojemników zostało wyłożone zabezpieczającą gąbką, co zapobiega przesuwaniu się przenoszonego sprzętu wewnątrz pojemnika. Walizki pomieszczą różnej wielkości narzędzia. Doskonale nadają się do przechowywania wiertarek, wkrętarek, szlifierek kątowych, wyrzynarek oraz innych elektronarzędzi. Pojemniki zabezpieczają narzędzia przed uszkodzeniem i zabrudzeniem podczas transportu. Wygodne zapięcia umożliwiają maksymalny udźwig każdego pojemnika.



Tool Case Premium

Skrzynka na elektronarzędzia Tool Case Premium

Product info

informacje o produkcji

400 [L] x 320 [W] x 180 [H] mm

Colour	Index	EAN		
	ELEKTROPRECZAPG001	5902455501178	77	7



Carriage Basic

Nosidło Basic

Product info

informacje o produkcie

392 [L] x 279 [W] x 143 [H] mm

Colour	Index	EAN		
	NOSMCZAPG001	5901238247371	768	8

Carriage handle
Rączka

Carriage
Nosidło

Ergonomic packaging
Ergonomiczne pakowanie



Carriage Premium

Nosidło Premium

Product info

informacje o produkcie

520 [L] x 320 [W] x 195 [H] mm

Colour	Index	EAN		
	NOSPREZAPG001	5902455501581	170	5

Carriage handle
Rączka

Carriage
Nosidło

Ergonomic packaging
Ergonomiczne pakowanie



ORGANIZERS

ORGANIZERY

Organizery są przeznaczone do przechowywania nawet najdrobniejszych elementów warsztatu. Można w nich magazynować i segregować śrubki, wkręty od najmniejszych rozmiarów do nawet tych niestandardowych. Wyjmowane pojemniki pozwalają na przenoszenie magazynowanych akcesoriów w miejscu pracy.

Można w nich magazynować i segregować śrubki, wkręty od najmniejszych rozmiarów do nawet tych niestandardowych. Wyjmowane pojemniki pozwalają na przenoszenie magazynowanych akcesoriów w miejscu pracy. Poliwęglanowe przezroczyste zabezpieczają wybrane organizery przed uszkodzeniami mechanicznymi.

Organizers are designed to store even the smallest elements of the workshop. You can store and segregate bolts, screws from the smallest sizes to even non-standard ones.

Removable containers allow you to carry stored accessories in the workplace. Polycarbonate cover protects selected organizers against mechanical damage.





Organizer HD

HD 400
HD 600

Organizery HD

HD 400 are top organizers in offer of Patrol Group, which has a super solid construction - reinforced body, polycarbonate cover, anti-shock corners - ensures trouble-free operation even in the most extreme conditions. HD organizers (models with containers Combibox HD) allow for convenient storage and transportation of large and heavy accessories.

HD 400 to topowy organizer w ofercie Patrol Group, który dzięki super wytrzymałej konstrukcji - wzmocniony korpus, poliwęglanowa pokrywa, masywne narożniki - zapewnia bezproblemową eksploatację nawet w najbardziej ekstremalnych warunkach. Organizer HD 400 w wersji z pojemnikami Combibox HD pozwala na komfortowe przechowywanie i transport dużych i ciężkich akcesoriów.



Super solid polycarbonate cover.

Super wytrzymałe, poliwęglanowe pokrywy.



Organizer HD

HD 400 Flex
HD 600 Flex

Organizery HD



Organizers HD Flex with adjustable dividers allow you to freely arrange storage space. With this solution, each user will be able to personalize the organizer under their individual needs.

Organizery HD Flex w wersji z regulowanymi przegrodami pozwalają na swobodne aranżowanie przestrzeni użytkowej. Dzięki takiemu rozwiązaniu, każdy użytkownik będzie mógł spersonalizować organizer pod swoje, indywidualne potrzeby.



Super solid polycarbonate cover.

Super wytrzymałe, poliwęglanowe pokrywy.



Organizer HD 400

Organizer HD 400

Product info

informacje o produkcie

390 [L] x 400 [W] x 110 [H] mm 390 [L] x 600 [W] x 110 [H] mm

Colour	Index	EAN		
	ORGHD400CZAPG001	5901238224754	108	6

Polycarbonate cover
Poliwęglanowa pokrywa

Anti-shock Corners
Antywstrząsowe narożniki

Aluminum Latches
Aluminiowe zapiecia

12 x Combibox HD
12 x Combibox HD



Organizer HD 400 Flex

Organizer HD 400 Flex

Product info

informacje o produkcie

390 [L] x 400 [W] x 110 [H] mm 390 [L] x 600 [W] x 110 [H] mm

Colour	Index	EAN		
	ORGHD400FCZAPG001	5901238233381	108	6

Polycarbonate cover
Poliwęglanowa pokrywa

Anti-shock Corners
Antywstrząsowe narożniki

Aluminum Latches
Aluminiowe zapiecia

Adjustable dividers
Regulowane przegrody



Organizer HD 600

Organizer HD 600

Product info

informacje o produkcie

390 [L] x 600 [W] x 110 [H] mm 390 [L] x 600 [W] x 110 [H] mm

Colour	Index	EAN		
	ORGHD600CZAPG001	5901238225119	72	4

Polycarbonate cover
Poliwęglanowa pokrywa

Anti-shock Corners
Antywstrząsowe narożniki

Aluminum Latches
Aluminiowe zapiecia

20 x Combibox HD
20 x Combibox HD



Organizer HD 600 Flex

Organizer HD 600 Flex

Product info

informacje o produkcie

390 [L] x 600 [W] x 110 [H] mm 390 [L] x 600 [W] x 110 [H] mm

Colour	Index	EAN		
	ORGHD600FCZAPG001	5901238237600	72	4

Polycarbonate cover
Poliwęglanowa pokrywa

Anti-shock Corners
Antywstrząsowe narożniki

Aluminum Latches
Aluminiowe zapiecia

Adjustable dividers
Regulowane przegrody





Organizer HD 400 Mix

Organizer HD 400 Mix

Product info

informacje o produkcie

390 [L] x 400 [W] x 110 [H] mm 390 [L] x 600 [W] x 110 [H] mm

Colour	Index	EAN		
	ORGH400MXCZAPG001	5901238243472	108	6

Polycarbonate cover
Poliwęglanowa pokrywa

Anti-shock Corners
Antywstrząsowe narożniki

Aluminum Latches
Aluminiowe zapięcia

8 x Combibox HD
+ 4x adjustable dividers
8 x Combibox HD
+ 4x regulowane przegrody



Organizer HD 600 Mix

Organizer HD 600 Mix

Product info

informacje o produkcie

390 [L] x 600 [W] x 110 [H] mm 390 [L] x 600 [W] x 110 [H] mm

Colour	Index	EAN		
	ORGH600MXCZAPG001	5901238243489	72	4

Polycarbonate cover
Poliwęglanowa pokrywa

Anti-shock Corners
Antywstrząsowe narożniki

Aluminum Latches
Aluminiowe zapięcia

8 x Combibox HD
+ 12x adjustable dividers
8 x Combibox HD
+ 12x regulowane przegrody



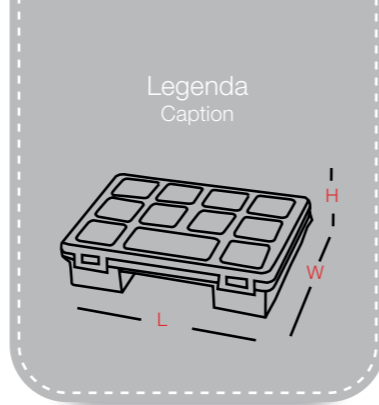

Organizers TANDEM

Organizery Tandem

Tandem organizers are available in three different versions A, B and C. The first has fixed partitions for small items. The second's feature are adjustable ones. Version C has a set of containers CombiBox. The entire line is characterized by durability, functionality, aesthetic finish and modern design. The two organizers of each size can be combined so that they gain additional functionality both during storage and handling.

Organizery Tandem dostępne są w trzech różnych wersjach A, B oraz C. Pierwsza posiada stałe przegrody na drobne elementy. Drugą charakteryzują wyjmowane przegrody. Wersja C posiada zestaw pojemników CombiBox. Całą linię cechuje wytrzymałość, funkcjonalność, estetyczne wykończenie oraz nowoczesny design. Dwa organizery z każdego rozmiaru można łączyć, dzięki czemu zyskują one dodatkową funkcjonalność zarówno podczas przechowywania, jak i przenoszenia.

TANDEM A



Compartments – thanks to which all small accessories kept in the organizer will always be in their right place.

Przegrody - dzięki nim wszystkie drobne akcesoria przechowywane w organizerze będą zawsze na właściwym miejscu.



TANDEM B



Adjustable compartments allow you to adjust their size to the size of the stored accessories. With this functionality you can effortlessly adjust the organizer to individual needs.

Regulowane przegrody pozwalają na dopasowanie ich wielkości do rozmiarów przechowywanych akcesoriów. Dzięki tej funkcjonalności można bez wysiłku dostosować organizer do indywidualnych potrzeb.

Adjustable dividers
Regulowane przegrody



TANDEM C



Transparent cover – helps to find quickly necessary elements.

Transparentna pokrywa - umożliwia szybkie odszukanie potrzebnych elementów.



Combiboxes – they facilitate the storage of small elements. Available in 4 sizes, giving you a possibility to match their size with your individual needs.

CombiBoxy - znacznie ułatwiają magazynowanie drobnych elementów. Występujące w 4 rozmiarach, dają możliwość dopasowania ich wielkości do indywidualnych potrzeb.

TANDEM TWIN

Hinges – they allow you to join organizers together and carry larger number of items at once.

Zawiasy - umożliwiają łączenie organizerów i przenoszenie jednorazowo większej ilości elementów.



Tandem Twin - combining two organizers with covers inside helps to protect lid from scratches. Tandem Twin is a great solution when significant numbers of accessories or small tools need to be moved.

Tandem Twin - połączenie organizerów pokrywkami do siebie zmniejsza prawdopodobieństwo rysowania się przeźroczy. Tandem Twin stanowi także znaczne ułatwienie przy transporcie sporej ilości drobnych elementów.



*tools not included/nie zawiera narzędzi



Organizer Tandem A 200

Organizer Tandem A 200

Product info

informacje o produkcie

192 [L] x 143 [W] x 50 [H] mm

Colour	Index	EAN		
	ORGA200TCCZAPG001	5901238215813	1344	28

Transparent cover
Przezroczysta pokrywa
6 compartments
6 komór



Organizer scheme
Rozkład organizera





Organizer Tandem B 200

Organizer Tandem B 200

Product info

informacje o produkcie

192 [L] x 143 [W] x 50 [H] mm

Colour	Index	EAN		
	ORGB200TCZAPG001	5901238209591	1344	28

Transparent cover
Przezroczysta pokrywa

5 adjustable dividers
5 regulowanych przegród
11 maximum compartments
11 komór maksymalnie



Organizer scheme
Rozkład organizera



*Adjustable dividers inserted loosely inside
Ruchome przegrody włożone luźno do organizera

Organizer Tandem A 300

Organizer Tandem A 300

Product info

informacje o produkcie

284 [L] x 192 [W] x 50 [H] mm

Colour	Index	EAN		
	ORGA300TCCZAPG001	5901238243595	576	24

Transparent cover
Przezroczysta pokrywa
8 compartments
8 komór



Organizer scheme
Rozkład organizera





Organizer Tandem B 300

Organizer Tandem B 300

Product info

informacje o produkcie

284 [L] x 192 [W] x 50 [H] mm

Colour	Index	EAN		
	ORGB300TCZAPG001	5901238209607	576	24

Transparent cover
Przezroczysta pokrywa

10 adjustable dividers
10 regulowanych przegród
14 maximum compartments
14 komór maksymalnie



Organizer scheme
Rozkład organizera



*Adjustable dividers inserted loosely inside
Ruchome przegrody włożone luźno do organizera

Organizer Tandem A 400

Organizer Tandem A 400

Product info

informacje o produkcie

385 [L] x 283 [W] x 50 [H] mm

Colour	Index	EAN		
	ORGA400TCCZAPG001	5901238244196	288	12

Transparent cover
Przezroczysta pokrywa
11 compartments
11 komór



Organizer scheme
Rozkład organizera





Organizer Tandem B 400

Organizer Tandem B 400

Product info

informacje o produkcie

385 [L] x 283 [W] x 50 [H] mm

Colour	Index	EAN		
	ORGB400TCZAPG001	5901238209614	288	12

Transparent cover
Przezroczysta pokrywa

21 adjustable dividers
21 regulowanych przegród
27 maximum compartments
27 komór maksymalnie

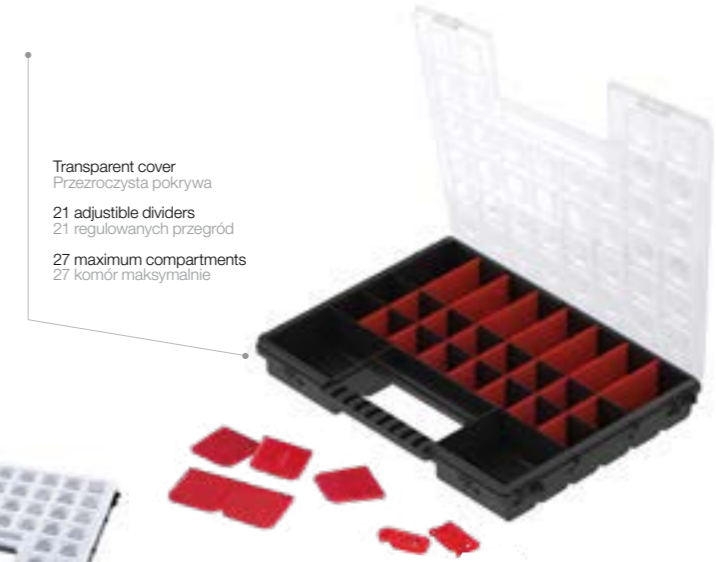

Organizer scheme
Rozkład organizera



*Adjustable dividers inserted loosely inside
Ruchome przegrody włożone luźno do organizera

Organizer Tandem C 200

Organizer Tandem C 200

Product info

informacje o produkcie

192 [L] x 143 [W] x 50 [H] mm

Colour	Index	EAN		
	ORGC200TCZAPG001	5901238209621	1344	28

 **Organizer scheme**
Rozkład organizera

Transparent cover
Przezroczysta pokrywa

4 Comboxes
4 Kombiboksy

3 Compartments
3 Komory





Organizer Tandem 200 Twin

Organizer Tandem 200 Twin

Product info

informacje o produkcie

192 [L] x 143 [W] x 100 [H] mm

Type	Index	EAN		
A	ORGA200TX2CZAPG001	5901238209935	576	12
B	ORGB200TX2CZAPG001	5901238209966	576	12
C	ORGC200TX2CZAPG001	5901238209997	576	12

 **Organizer scheme**
Rozkład organizera

Transparent cover A/B/C
Przezroczysta pokrywa A/B/C

Komory A
Compartments A

Dividers B
Przegrody B

Comboxes C
Kombiboksy C

Hinges A/B/C
Zawiasy A/B/C



Organizer Tandem C 300

Organizer Tandem C 300

Product info

informacje o produkcie

284 [L] x 192 [W] x 50 [H] mm

Colour	Index	EAN		
	ORGC300TCZAPG001	5901238209638	576	24

 **Organizer scheme**
Rozkład organizera

Transparent cover
Przezroczysta pokrywa

8 Comboxes
8 Kombiboksów

2 Compartments
2 Komory



Organizer Tandem 300 Twin

Organizer Tandem 300 Twin

Product info

informacje o produkcie

284 [L] x 192 [W] x 100 [H] mm

Type	Index	EAN		
A	ORGA300TCX2CZAPG001	5901238244226	288	12
B	ORGB300TX2CZAPG001	5901238209973	288	12
C	ORGC300TX2CZAPG001	5901238210009	288	12

 **Organizer scheme**
Rozkład organizera

Transparent cover A/B/C
Przezroczysta pokrywa A/B/C

Komory A
Compartments A

Dividers B
Przegrody B

Comboxes C
Kombiboksy C

Hinges A/B/C
Zawiasy A/B/C



Organizer Tandem C 400

Organizer Tandem C 400

Product info

informacje o produkcie

385 [L] x 283 [W] x 50 [H] mm

Colour	Index	EAN		
	ORGC400TCZAPG001	5901238209645	288	12

 **Organizer scheme**
Rozkład organizera

Transparent cover
Przezroczysta pokrywa

Comboxes
Kombiboksy

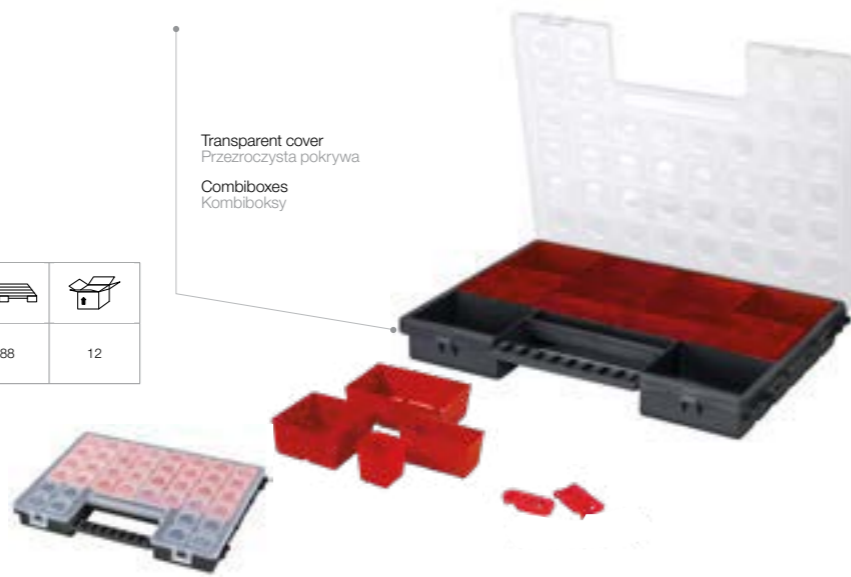

Organizer Tandem 400 Twin

Organizer Tandem 400 Twin

Product info

informacje o produkcie

385 [L] x 283 [W] x 100 [H] mm

Type	Index	EAN		
A	ORGA400TCX2CZAPG001	5901238244233	144	6
B	ORGB400TX2CZAPG001	5901238209980	144	6
C	ORGC400TX2CZAPG001	5901238210016	144	6

 **Organizer scheme**
Rozkład organizera

Transparent cover A/B/C
Przezroczysta pokrywa A/B/C

Komory A
Compartments A

Dividers B
Przegrody B

Comboxes C
Kombiboksy C

Hinges A/B/C
Zawiasy A/B/C





Organizers DOMINO

Organizery Domino

The organizers are perfect for both professional work and hobby. They help you to arrange all components, and thanks to their transparent covers, you can easily determine what is inside. Organizer 32, 36 and 45 is additionally equipped with a handle and a system of removable partitions. Whole line characterizes weight, convenience and aesthetic design.

Organizery idealnie nadają się do pracy zawodowej, jak i do zajęć hobbystycznych. Pozwalają na posegregowanie wszystkich detali, a dzięki przezroczystej pokrywie łatwo określić, co się w nich znajduje. Organizer 32, 36 oraz 45 został dodatkowo wyposażony w rączkę i system wyjmowanych przegród. Całą serię cechuje lekkość, poręczność i estetyczne wykonanie.



*Adjustable dividers inserted loosely inside
Ruchome przegrody włożone luźno do organizera



Adjustable dividers
Regulowane przegrody

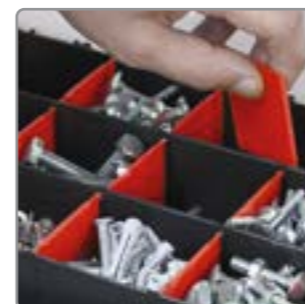

Adjustable dividers – allow you to adjust the product to your individual needs.

Regulowane przegrody - pozwalają przystosować produkt do indywidualnych potrzeb.



Transparent cover – helps to find necessary elements in a really short time.

Transparentna pokrywa - umożliwia szybkie odzyskanie potrzebnych elementów.



Compartments – thanks to which, all small accessories kept in the organizer will always be in their right place.

Komory - dzięki nim wszystkie drobne akcesoria przechowywane w organizerze będą zawsze na właściwym miejscu.



Latches 36 – they protect small elements kept in the organizer from falling out.

Zapięcia 36 - zabezpieczają przed wypadaniem znajdujących się w organizerze elementów.



*tools not included/nie zawiera narzędzi



Organizer Domino 19

Organizer Domino 19

Product info

informacje o produkcie

190 [L] x 155 [W] x 37 [H] mm

Colour	Index	EAN		
	ORG19DOMCZAPG001	5902455507040	1536	32



Transparent cover
Przezroczysta pokrywa
8 compartments
8 komór



Organizer Domino 25

Organizer Domino 25

Product info

informacje o produkcie

250 [L] x 200 [W] x 44 [H] mm

Colour	Index	EAN		
	ORG25DOMCZAPG001	5902455507057	768	16



Transparent cover
Przezroczysta pokrywa
12 compartments
12 komór



Organizer Domino 32

Organizer Domino 32

Product info

informacje o produkcie

325 [L] x 260 [W] x 65 [H] mm

Colour	Index	EAN		
	ORG32DOMCZAPG001	5901238244202	300	10



Transparent cover
Przezroczysta pokrywa
Latches
Zapięcia
15 adjustable dividers
15 regulowanych przegród
22 maximum compartments
22 komór maksymalnie



*Adjustable dividers inserted loosely inside
Ruchome przegrody włożone luźno do organizera



Organizer Domino 36

Organizer Domino 36

Product info

informacje o produkcie

364 [L] x 268 [W] x 66 [H] mm

Colour	Index	EAN		
	ORG36DOMCZAPG001	5902455508443	270	10



Transparent cover
Przezroczysta pokrywa
Latches
Zapięcia
15 adjustable dividers
15 regulowanych przegród
22 maximum compartments
22 komór maksymalnie

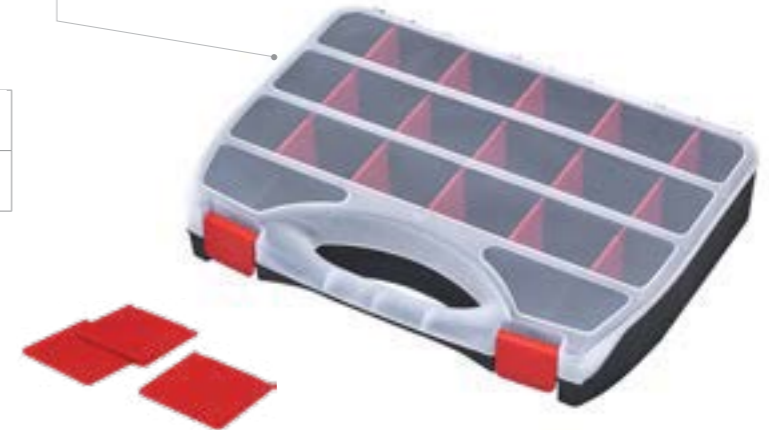

*Adjustable dividers inserted loosely inside
Ruchome przegrody włożone luźno do organizera



Organizer Domino 45

Organizer Domino 45

Product info

informacje o produkcie

450 [L] x 340 [W] x 68 [H] mm

Colour	Index	EAN		
	ORG45DOMCZAPG001	5901238244219	150	5



Transparent cover
Przezroczysta pokrywa
Latches
Zapięcia
20 adjustable dividers
20 regulowanych przegród
28 maximum compartments
28 komór maksymalnie



*Adjustable dividers inserted loosely inside
Ruchome przegrody włożone luźno do organizera

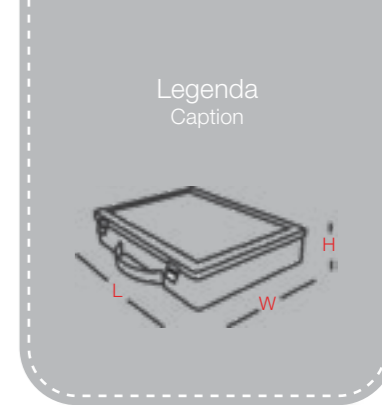

Organizers **CLASSIC**

Organizery Classic

Thanks to the organizers, all small accessories will always be within reach and in their right place. Most models are equipped with a handle, and in the case of the XL organizer you can adjust the number and the size of its compartments, allowing you to adapt the product with your individual needs.

Dzięki nim wszystkie drobne akcesoria będą zawsze pod ręką i na właściwym miejscu. Większość modeli wyposażonych jest w rączkę, a w organizerze XL ilość i wielkość komór jest regulowana, co pozwala przystosować produkt do indywidualnych potrzeb.



Handle – comfortable handle enhancing the comfort of use.

Rączka - szeroka, wygodna rączka zwiększa komfort użytkowania.



Adjustable compartments – allow you to adjust the product to your individual needs.

Regulowane przegrody - pozwalają przystosować produkt do indywidualnych potrzeb.



Compartments – thanks to which, all small accessories kept in the organizer will always be in their right place.

Komory - dzięki nim wszystkie drobne akcesoria przechowywane w organizerze będą zawsze na właściwym miejscu.

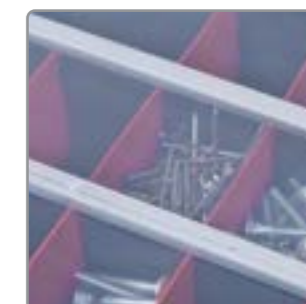

Transparent cover – helps to quickly find necessary elements in a really short time.

Transparentna pokrywa - umożliwia szybkie odszukanie potrzebnych elementów.

*tools not included/nie zawiera narzędzi

Organizer Classic 300

Organizer Classic 300

Product info

informacje o produkcie

300 [L] x 220 [W] x 55 [H] mm

Colour	Index	EAN		
	ORG300CZAPG001	5902455501574	420	10



Organizer scheme
Rozkład organizera

Transparent cover
Przezroczysta pokrywa

Handle
Rączka

10 compartments
10 komór





Organizer Classic XL

Organizer Classic XL

Product info

informacje o produkcie

460 [L] x 325 [W] x 80 [H] mm

Colour	Index	EAN		
	ORGXLCZAPG001	5902455500003	125	5



Organizer scheme
Rozkład organizera

Transparent cover
Przezroczysta pokrywa

Comfortable XL handle
Wygodna rączka XL

21 adjustable dividers
21 regulowanych przegród

26 maximum compartments
26 komór maksymalnie

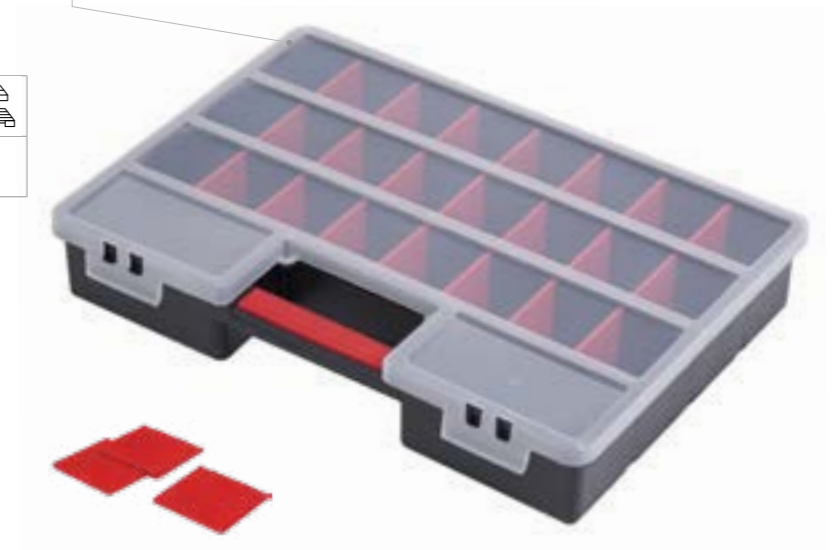

*Adjustable dividers inserted loosely inside
Ruchome przegrody włożone luzno do organizera

Organizer Classic 350

Organizer Classic 350

Product info

informacje o produkcie

345 [L] x 245 [W] x 60 [H] mm

Colour	Index	EAN		
	ORG350CZAPG001	5902455501840	270	10



Organizer scheme
Rozkład organizera

Transparent cover
Przezroczysta pokrywa

Handle
Rączka

11 compartments
11 komór

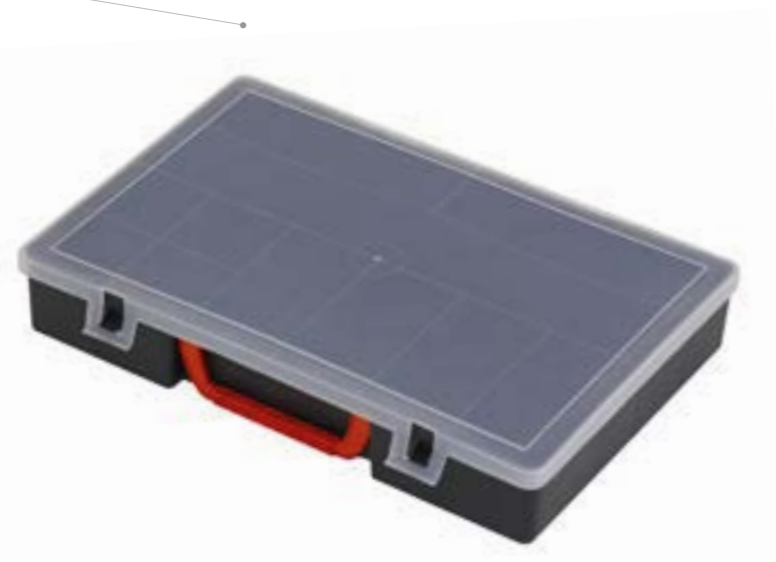



Combiboxes

Kombiboksy

Combiboxes greatly facilitate the storage of small elements. They are available in 4 sizes and can be used as an individual product, or supplement to virtually any box, container or organizer.

Kombiboksy znacznie ułatwiają magazynowanie drobnych elementów. Występujące w 4 rozmiarach, mogą stanowić samodzielny produkt lub być uzupełnieniem praktycznie każdej skrzynki, pojemnika, czy organizera.



Supplement to organizer inside the ToolBox Formula RS
Uzupełnienie organizera w skrzynce Formula RS



Single product packaged in display
Samodzielny produkt pakowany w display







Supplement to organizer inside the Tandem C
Uzupełnienie organizera w Tandemie C

Combibox 1 - 5 pcs

Kombiboks 1 - 5 sztuk

Product info

informacje o produkcie

 41 [L] x 41 [W] x 45 [H] mm	SET 41 [L] x 41 [W] x 110 [H] mm			
Colour	Index	EAN		
	Z213604PG001	5901238213604	8640	96







Combibox 2 - 5 pcs

Kombiboks 2 - 5 sztuk

Product info

informacje o produkcie

 41 [L] x 84 [W] x 45 [H] mm	SET 41 [L] x 84 [W] x 110 [H] mm			
Colour	Index	EAN		
	Z213611PG001	5901238213611	4320	48

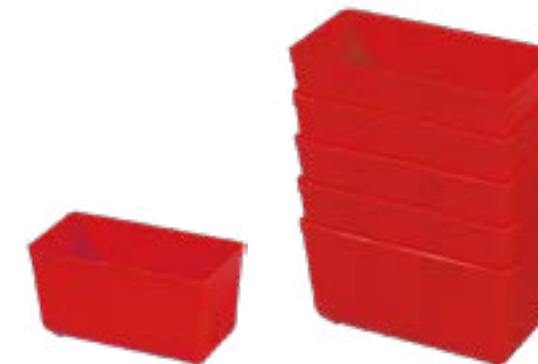





Combibox 3 - 5 pcs

Kombiboks 3 - 5 pcs

Product info

informacje o produkcie

 84 [L] x 84 [W] x 45 [H] mm	SET 84 [L] x 84 [W] x 105 [H] mm			
Colour	Index	EAN		
	Z213628PG001	5901238213628	2160	24







Combibox 4 - 3 pcs

Kombiboks 4 - 3 pcs

Product info

informacje o produkcie

 124 [L] x 84 [W] x 45 [H] mm	SET 124 [L] x 84 [W] x 80 [H] mm			
Colour	Index	EAN		
	Z213635PG001	5901238213635	2160	24



WORKSHOP

AKCESORIA WARSZTATOWE

The entire family of our products allows you to save storage space. A special system of "latches" makes it possible to build modulboxes and create walls of several meters. The product is ideal for stores and workshops. The containers are durable and easy to use.

Ergoboxes are constructed in way to make it possible to put one inside another, which exceptionally improves the logistics. On the other hand, the Combiboxes facilitate the storage of small elements. They are available in 4 sizes and can be used as individual product, or as a supplement to virtually any box, container or organizer.

Oszczędność miejsca i stabilność to największe atuty tej rodziny produktów. Specjalny system „zatrząsków” pozwala na budowanie z modułboxów nawet kilkunastometrowych ścian. Produkt nadaje się idealnie do sklepów i warsztatów.

Pojemniki te są wytrzymałe i łatwe w użytkowaniu. Ergoboxy zostały skonstruowane z opcją wkładania jeden w drugi, co niezwykle ułatwia ich pakowanie i poprawia ich logistykę. Z kolei Kombiboksy znacznie upraszczają magazynowanie drobnych elementów. Występujące w 4 rozmiarach mogą stanowić samodzielny produkt, lub być uzupełnieniem praktycznie każdej skrzynki, pojemnika czy organizera.





Ergonomic packing – storing one container inside another container exceptionally improves the logistics of packing.

Ergonomiczne pakowanie - magazynowanie pojemników jeden w drugim niezwykle ułatwia ich pakowanie i poprawia ich logistykę.



Slat attachments – you can attach it with screws along with containers to a wall, improving the way you use the space.

Listwa - można ją przykręcić wraz z pojemnikami do ściany umożliwiając tym samym lepsze wykorzystanie przestrzeni.

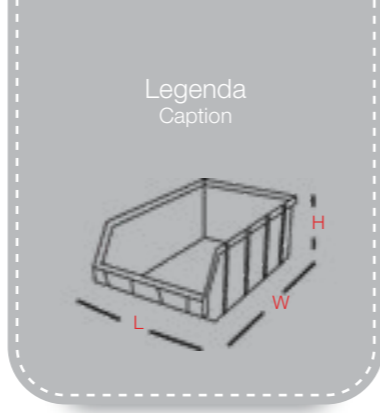

Ecobox Ergobox Plus



Possibility of stacking – arranging the products one on top of another significantly economizes space, which is a great advantage in case of small workshops.

Możliwość piętrowania - umożliwia znaczną oszczędność miejsca, co staje się udogodnieniem w niewielkich warsztatach.



Modules – special latches make it possible to create even several meters walls of modulboxes.

Moduły - specjalne zatrzaski pozwalają budować moduły nawet kilkumetrowych ścian.



Fixing wall – it is a useful addition to the containers. Those racks can hold several containers of different sizes, which is very useful in small workshops.

Płyta warsztatowa - stanowi niezmiernie użyteczny dodatek do pojemników. Przywiercona do ściany może pomieścić nawet kilka pojemników w różnych rozmiarach, co jest niezwykle przydatne w niewielkich warsztatach.



Space for label – a place designed for a label allows you to write down what elements are kept in the box; in this way, you will be able to identify them more readily.

Miejsce na etykietę - specjalne miejsce na naklejkę pozwala podisać, jakie elementy są w pojemniku przechowywane, a to ułatwia ich szybkie zidentyfikowanie.

Ergobox Plus use also with:
Ergobox Plus używaj również z:



Stuff Module System

Metal & Plastic Slat

Fixing Wall 350

Ergobox Plus containers, which separately or in combination with other products form a perfect module for storing tools and workshop accessories.

Ergobox Plus to pojemniki, które samodzielnie lub w połączeniu z innymi produktami tworzą idealny moduł do przechowywania narzędzi i akcesoriów warsztatowych.

*tools not included/nie zawiera narzędzi



Wide variety of storage containers allows for easy optimisation and organisation of workshop space. Saving space and stability are the most important features of this line of products. Available in five sizes Modulbox containers let you build entire workshop walls for storage. Ergobox containers can be stacked in order to significantly increase their logistics and packaging. Stacking containers allows to save and optimize workspace event in the tiniest of spaces. Slat in our offer alongside tool walls, pegboards and various kits can really impact your approach to organising your workshop space.

Szeroka oferta pojemników magazynowych pozwala zoptymalizować przestrzeń w warsztacie. Oszczędność miejsca i stabilność to największe atuty tej rodziny produktów. Dostępne w pięciu rozmiarach pojemniki MODULBOX pozwalają na budowę nawet kilkunastometrowych regałów warsztatowych. Konstrukcja pojemników ERGOBOX pozwala na magazynowanie pojemników jeden w drugim, co niezwykle ułatwia ich pakowanie oraz poprawia logistykę. Możliwość piętrowania pojemników zapewnia oszczędność miejsca, nawet w niewielkich pomieszczeniach. Dostępne w naszej ofercie płyty i listwy warsztatowe w połączeniu z Ecoboxami i Ergoboxami stanowią niezastąpione zestawy do organizacji warsztatu. Specjalne miejsce na etykietę pozwala na łatwą i szybką identyfikację akcesoriów narzędziowych.







Ecobox Mini

Ecobox Mini

Product info

informacje o produkcie

110 [L] x 90 [W] x 50 [H] mm

Colour	Index	EAN		
	ECOMINCZAPG001	5902455502779	3936	41
	ECOMINCZEPG001	5902455502793	3936	41
	ECOMINIEPG001	5902455502786	3936	41
	ECOMINZIEPG001	5902455502816	3936	41
	ECOMINZOLPG001	5902455502809	3936	41

Possibility of stacking
Możliwość piętrzenia

Space for label
Miejsce na etykietę

*Optional:
*Opcjonalnie:

Metal or plastic slat
Listwa metalowa lub plastikowa

Fixing wall
Płyta warsztatowa

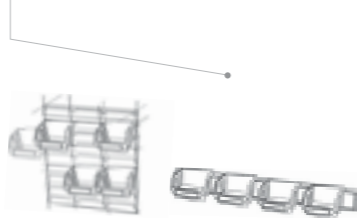









Ergobox 1

Ergobox 1

Product info

informacje o produkcie

116 [L] x 112 [W] x 75 [H] mm

Colour	Index	EAN		
	ERG1CZAPG001	5907763088892	4800	48
	ERG1CZEPG001	5907763088915	4800	48
	ERG1NIEPG001	5907763088908	4800	48
	ERG1ZIEPG001	5901238214380	4800	48
	ERG1ZOLPG001	5901238212980	4800	48
	ERG1POMPG001	5901238238881	4800	48

Ergonomic packing
Ergonomiczne pakowanie

Possibility of stacking
Możliwość piętrzenia

Space for label
Miejsce na etykietę

*Optional:
*Opcjonalnie:

Metal or plastic slat
Listwa metalowa lub plastikowa

Fixing wall
Płyta warsztatowa

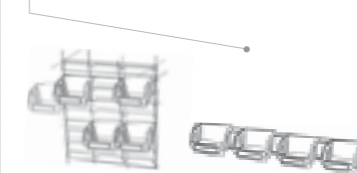







Ecobox Small

Ecobox Small

Product info

informacje o produkcie

107 [L] x 165 [W] x 75 [H] mm

Colour	Index	EAN		
	ECOMALCZAPG001	5902455501154	1680	35
	ECOMALCZEPG001	5902455501314	1680	35
	ECOMALNIEPG001	5902455501321	1680	35
	ECOMALZIEPG001	5902455501338	1680	35
	ECOMALZOLPG001	5902455501147	1680	35

Possibility of stacking
Możliwość piętrzenia

Space for label
Miejsce na etykietę

*Optional:
*Opcjonalnie:

Metal or plastic slat
Listwa metalowa lub plastikowa

Fixing wall
Płyta warsztatowa

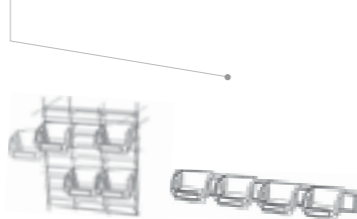









Ergobox 1 Plus

Ergobox 1 Plus

Product info

informacje o produkcie

116 [L] x 112 [W] x 75 [H] mm

Colour	Index	EAN		
	ERG1PCZAPG001	5901238242772	2400	24
	ERG1PCZEPG001	5901238242789	2400	24
	ERG1PNEPG001	5901238242796	2400	24
	ERG1PZIEPG001	5901238242802	2400	24
	ERG1PZOLPG001	5901238242819	2400	24
	ERG1PPOMPG001	5901238242826	2400	24

Ergonomic packing
Ergonomiczne pakowanie

Possibility of stacking
Możliwość piętrzenia

Space for label
Miejsce na etykietę

*Optional:
*Opcjonalnie:

Metal or plastic slat
Listwa metalowa lub plastikowa

Fixing wall
Płyta warsztatowa

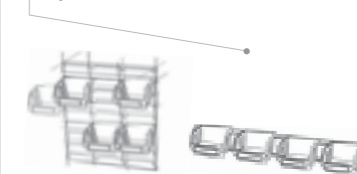







Ecobox Medium

Ecobox Medium

Product info

informacje o produkcie

155 [L] x 240 [W] x 125 [H] mm

Colour	Index	EAN		
	ECOSREZAPG001	5902455501383	490	35
	ECOSREZEPG001	5902455501161	490	35
	ECOSRENEPG001	5902455501352	490	35
	ECOSREZIEPG001	5902455501369	490	35
	ECOSREZOLPG001	5902455501376	490	35

Possibility of stacking
Możliwość piętrzenia

Space for label
Miejsce na etykietę

*Optional:
*Opcjonalnie:

Metal or plastic slat
Listwa metalowa lub plastikowa

Fixing wall
Płyta warsztatowa

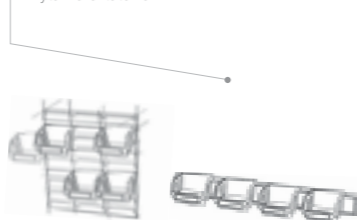

Ergobox 2

Ergobox 2

Product info

informacje o produkcie

116 [L] x 161 [W] x 75 [H] mm

Colour	Index	EAN		
	ERG2CZAPG001	5907763088922	3600	36
	ERG2CZEPG001	5907763088946	3600	36
	ERG2NIEPG001	5907763088939	3600	36
	ERG2ZIEPG001	5901238214571	3600	36
	ERG2ZOLPG001	5902455508658	3600	36
	ERG2POMPG001	5901238238898	3600	36

Ergonomic packing
Ergonomiczne pakowanie

Possibility of stacking
Możliwość piętrzenia

Space for label
Miejsce na etykietę

*Optional:
*Opcjonalnie:

Metal or plastic slat
Listwa metalowa lub plastikowa

Fixing wall
Płyta warsztatowa

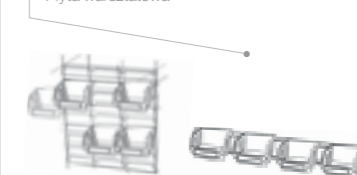







Ecobox Large

Ecobox Large

Product info

informacje o produkcie

220 [L] x 350 [W] x 165 [H] mm

Colour	Index	EAN		
	ECODUZCZAPG001	5902455501437	140	10
	ECODUZCZEPG001	5902455501390	140	10
	ECODUZNIEPG001	5902455501406	140	10
	ECODUZZIEPG001	5902455501413	140	10
	ECODUZZOLPG001	5902455501420	140	10

Possibility of stacking
Możliwość piętrzenia

Space for label
Miejsce na etykietę

*Optional:
*Opcjonalnie:

Metal or plastic slat
Listwa metalowa lub plastikowa

Fixing wall
Płyta warsztatowa

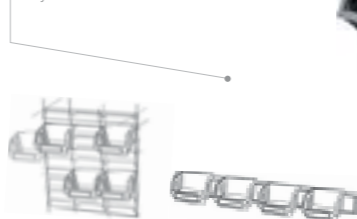

Ergobox 2 Plus

Ergobox 2 Plus

Product info

informacje o produkcie

116 [L] x 161 [W] x 75 [H] mm

Colour	Index	EAN		
	ERG2PCZAPG001	5901238224600	1800	18
	ERG2PCZEPG001	5901238224570	1800	18
	ERG2PNEPG001	5901238224617	1800	18
	ERG2PZIEPG001	5901238236221	1800	18
	ERG2PZOLPG001	5901238236238	1800	18
	ERG2PPOMPG001	5901238238904	1800	18

Ergonomic packing
Ergonomiczne pakowanie

Possibility of stacking
Możliwość piętrzenia

Space for label
Miejsce na etykietę

*Optional:
*Opcjonalnie:

Metal or plastic slat
Listwa metalowa lub plastikowa

Fixing wall
Płyta warsztatowa

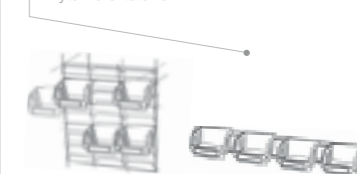







Ergobox 2L

Ergobox 2L

Product info

informacje o produkcie

116 [L] x 212 [W] x 75 [H] mm

Colour	Index	EAN		
	ERG2LCZAPG001	5907763089042	2400	24
	ERG2LCZEPG001	5907763089066	2400	24
	ERG2LNIEPG001	5907763089059	2400	24
	ERG2LZEPG001	5901238214465	2400	24
	ERG2LZOLPG001	5901238214472	2400	24
	ERG2LPOMPG001	5901238238942	2400	24

Ergonomic packing
Ergonomiczne pakowanie

Possibility of stacking
Możliwość piętrzenia

Space for label
Miejsce na etykietę

*Optional:
*Opcjonalnie:

Metal or plastic slat
Listwa metalowa lub plastikowa

Fixing wall
Płyta warsztatowa

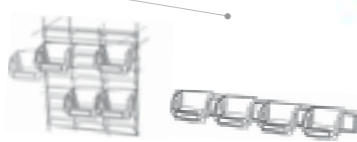









Ergobox 2L Plus

Ergobox 2L Plus

Product info

informacje o produkcie

116 [L] x 212 [W] x 75 [H] mm

Colour	Index	EAN		
	ERG2LPCZAPG001	5901238242833	1056	22
	ERG2LPCZEPG001	5901238242840	1056	22
	ERG2LPNIEPG001	5901238242857	1056	22
	ERG2LZIEPG001	5901238242864	1056	22
	ERG2LPZOLPG001	5901238242871	1056	22
	ERG2LPOMPG001	5901238242888	1056	22

Ergonomic packing
Ergonomiczne pakowanie

Possibility of stacking
Możliwość piętrzenia

Space for label
Miejsce na etykietę

*Optional:
*Opcjonalnie:

Metal or plastic slat
Listwa metalowa lub plastikowa

Fixing wall
Płyta warsztatowa

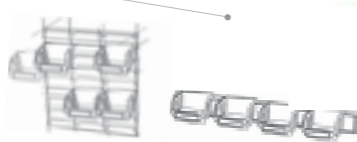





Ergobox 3

Ergobox 3

Product info

informacje o produkcie

170 [L] x 240 [W] x 126 [H] mm

Colour	Index	EAN		
	ERG3CZAPG001	5907763089953	1000	10
	ERG3CZEPG001	5907763089977	1000	10
	ERG3NIEPG001	5907763089960	1000	10
	ERG3ZIEPG001	5901238214403	1000	10
	ERG3ZOLPG001	5901238214410	1000	10
	ERG3POMPG001	5901238238911	1000	10

Ergonomic packing
Ergonomiczne pakowanie

Possibility of stacking
Możliwość piętrzenia

Space for label
Miejsce na etykietę

*Optional:
*Opcjonalnie:

Metal or plastic slat
Listwa metalowa lub plastikowa

Fixing wall
Płyta warsztatowa

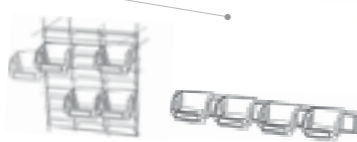









Ergobox 3 Plus

Ergobox 3 Plus

Product info

informacje o produkcie

170 [L] x 240 [W] x 126 [H] mm

Colour	Index	EAN		
	ERG3PCZAPG001	5901238242895	528	22
	ERG3PCZEPG001	5901238242901	528	22
	ERG3PNIEPG001	5901238242918	528	22
	ERG3PZIEPG001	5901238242925	528	22
	ERG3PZOLPG001	5901238242932	528	22
	ERG3PPOMPG001	5901238242949	528	22

Ergonomic packing
Ergonomiczne pakowanie

Possibility of stacking
Możliwość piętrzenia

Space for label
Miejsce na etykietę

*Optional:
*Opcjonalnie:

Metal or plastic slat
Listwa metalowa lub plastikowa

Fixing wall
Płyta warsztatowa

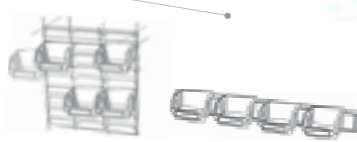









Ergobox 4

Ergobox 4

Product info

informacje o produkcie

204 [L] x 340 [W] x 155 [H] mm

Colour	Index	EAN		
	ERG4CZAPG001	5907763089894	1144	13
	ERG4CZEPG001	5907763089904	1144	13
	ERG4NIEPG001	5907763089891	1144	13
	ERG4ZIEPG001	5901238214427	1144	13
	ERG4ZOLPG001	5901238214434	1144	13
	ERG4POMPG001	5901238238928	1144	13

Ergonomic packing
Ergonomiczne pakowanie

Possibility of stacking
Możliwość piętrzenia

Space for label
Miejsce na etykietę











Ergobox 5

Ergobox 5

Product info

informacje o produkcie

333 [L] x 500 [W] x 187 [H] mm

Colour	Index	EAN		
	ERG5CZAPG001	5907763089011	300	5
	ERG5CZEPG001	5907763089035	300	5
	ERG5NIEPG001	5907763089028	300	5
	ERG5ZIEPG001	5901238214441	300	5
	ERG5ZOLPG001	5901238214458	300	5
	ERG5POMPG001	5901238238935	300	5

Ergonomic packing
Ergonomiczne pakowanie

Possibility of stacking
Możliwość piętrzenia

Space for label
Miejsce na etykietę



Modulbox 1.1

Modulbox 1.1

Product info

informacje o produkcie

110 [L] x 165 [W] x 75 [H] mm

Colour	Index	EAN		
	MOD11CZAPG001	5902455502533	1400	35

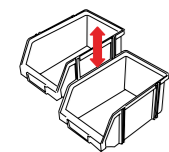

Modular
Modułowe

Possibility of stacking
Możliwość piętrzenia

Space for label
Miejsce na etykietę

*Optional:
*Opcjonalnie:

Metal or plastic slat
Listwa metalowa lub plastikowa

Fixing wall
Płyta warsztatowa



Modulbox 2.1

Modulbox 2.1

Product info

informacje o produkcie

150 [L] x 230 [W] x 125 [H] mm

Colour	Index	EAN		
	MOD21CZAPG001	5902455502540	490	35

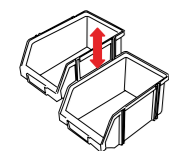

Modular
Modułowe

Possibility of stacking
Możliwość piętrzenia

Space for label
Miejsce na etykietę

*Optional:
*Opcjonalnie:

Metal or plastic slat
Listwa metalowa lub plastikowa

Fixing wall
Płyta warsztatowa



Modulbox 3.1

Modulbox 3.1

Product info

informacje o produkcie

210 [L] x 350 [W] x 160 [H] mm

Colour	Index	EAN		
	MOD31CZAPG001	5902455502557	192	12

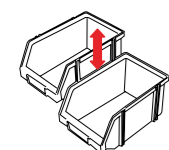

Modular
Modułowe

Possibility of stacking
Możliwość piętrzenia

Space for label
Miejsce na etykietę



Modulbox 4.1

Modulbox 4.1

Product info

informacje o produkcie

310 [L] x 490 [W] x 190 [H] mm

Colour	Index	EAN		
	MOD41CZAPG001	5902455502564	88	6

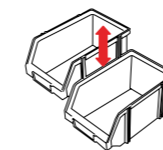

Modular
Modułowe

Possibility of stacking
Możliwość piętrzenia

Space for label
Miejsce na etykietę



Modulbox 4.1D

Modulbox 4.1D

Product info

informacje o produkcie

310 [L] x 490 [W] x 190 [H] mm

Colour	Index	EAN		
	MOD41DCZAPG001	5902455502595	88	6

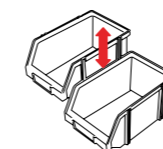

Modular
Modułowe

Possibility of stacking
Możliwość piętrzenia

Space for label
Miejsce na etykietę



Compartment
Stała przegroda

FIXING WALL

Zestaw płyty warsztatowej Fixing Wall

Board Workshop is a modern system for a professional workshop in even small spaces. Attached to the wall plate allows installation Ergobox containers in various sizes and combinations. In turn, a set of dedicated holders is a perfect solution for storing different tools.

Płyta Warsztatowa to nowoczesny system pozwalający na stworzenie profesjonalnego warsztatu w nawet niewielkich pomieszczeniach. Przymocowana do ściany płyta umożliwi montaż pojemników ErgoBox w różnych rozmiarach i kombinacjach. Z kolei zestaw dedykowanych uchwytów to idealne rozwiązanie do przechowywania zróżnicowanych narzędzi.



*tools not included/nie zawiera narzędzi

Fixing Wall 350 Set 1.1

Fixing Wall 350 Set 1.1

Product info

informacje o produkcie

345 [L] x 385 [W] x 90 [H] mm

Colour	Index	EAN		
	Z212379PG001	5901238212379	104	26

Fixing Wall 350 x1
Płyta warsztatowa 350 x1

Storage containers:
Pojemniki magazynowe:

Ergobox 1 red/czerwony x 3
Ergobox 1 black/czarny x 3
Ergobox 1 blue/niebieski x 3



Fixing Wall Starter

Fixing Wall Starter

Product info

informacje o produkcie

400 [L] x 360 [W] x 130 [H] mm

Colour	Index	EAN		
	Z221241PG001	5901238221241	90	6

Fixing Wall 350 black x2
Płyta 350 czarna x2

Fixing Wall accessories:
A11 red x1
Akcesoria płyty warsztatowej: A 11 czerwone x1

Storage containers:
Pojemniki magazynowe:
Ergobox 1 red/czerwony x 3
Ergobox 2 red/czerwony x 3
Ergobox 2L red/czerwony x 3



Fixing Wall Medium

Fixing Wall Medium

Product info

informacje o produkcie

600 [L] x 360 [W] x 155 [H] mm

Colour	Index	EAN		
	Z250081PG001	5901238250081	56	4

Fixing Wall 350 black x2
Płyta 350 czarna x2

Tool rack x1
Półka narzędziowa

Fixing Wall accessories:
A11 red x1/B12 red x1 (no hangers)
Akcesoria płyty warsztatowej:
A 11 czerwone x1/ B12 czerwone x1 (bez wieszaków)

Storage containers:
Pojemniki magazynowe:
Ergobox 1 red/czerwony x 3
Ergobox 2 red/czerwony x 3
Ergobox 2L red/czerwony x 3



PEGBOARD KIT

Płyta perforowana

Pegboard kit – individual tools will find their place, which guarantees that order is kept in every workshop.

Perforacja - pojedyncze narzędzia znajdują swoje stałe miejsce, co gwarantuje utrzymanie porządku w każdym warsztacie.



Very ergonomic handle to keep all your wrenches in one place and in order. It's lightweight, but durable enough to hold up to 9 different tools.

Bardzo ergonomiczny uchwyt, który pozwoli trzymać wszystkie klucze w jednym miejscu iw odpowiednim porządku. Lekki, ale wytrzymały pozwala trzymać do 9 kluczy naraz.



Another type of holder designed to hold tools like pliers or scissors that vary in length with ease, just move the lower element or upper element to a proper place on board and voila.

Kolejny typ uchwytu zaprojektowany, by trzymać narzędzia jak szczypce, kombinerki albo nożyczki różniące się długością w łatwy sposób. Wystarczy tylko przelożyć górny lub dolny element uchwytu i gotowe.



Simplest type of holder that can be used to store any object that hangs easily, like noise-reducing headphones.

Bardzo prosty typ uchwytu, który utrzyma wszystkie przedmioty, które mogą swobodnie zwisać, jak np. słuchawki wyciszające.



Very easy to use plug-in system for all types of holders helps keeping everything tidy and allows for very varied customization of your own pegboard.

Bardzo łatwy w użyciu system wtykający dla wszystkich typów akcesoriów pomaga w utrzymaniu porządku i zezwala na dużą personalizację powierzchni tablicy.

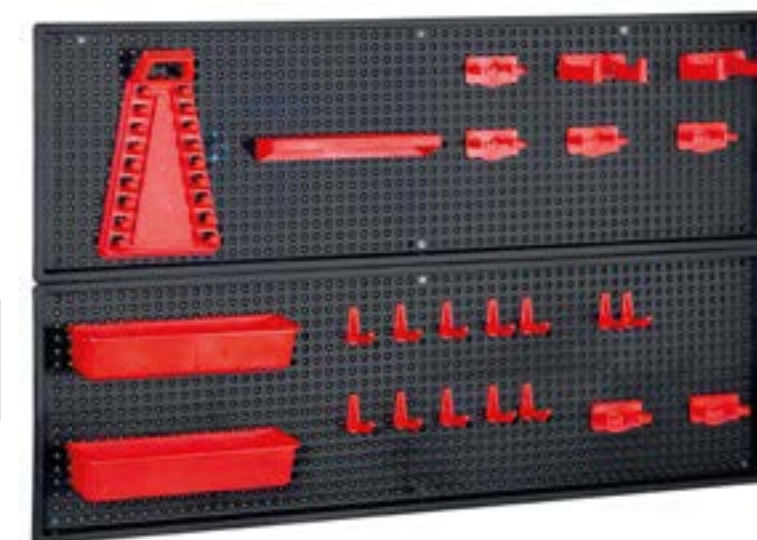



Pegboard kit

Perforacja

Product info

informacje o produkcie

800 [L] x 250 [W] x 500 [H] mm

Colour	Index	EAN		
	PERFORCZEPG001	5902455501505	126	9

*tools not included/nie zawiera narzędzi

TOOL WALL PANEL

Metalowa płyta narzędziowa

Tool Wall Panel is a new solution for organising your workshop. Available with a wide variety of supporting products and accessories can be a real game changer. 9 solid holsters for tools, with adapters for hanging containers lets you keep a lot of stuff on Tool Wall Panel. Ergonomic, 8-point latching system enables easy montage, both vertically and horizontally. What's more important Tool Wall Panel is corrosion resistant.

Metalowa płyta narzędziowa "Tool Wall Panel" to nowe rozwiązanie do organizacji warsztatu. Dostępna wraz ze zróżnicowaną ofertą akcesoriów do zawieszania. Aż 9 rodzajów solidnych zawieszek na narzędzia, w tym funkcjonalne adaptory na pojemniki niezbędne do przechowywania drobnych akcesoriów. Wygodny, 8-punktowy system mocowania płyty pozwala na łatwy montaż w każdym miejscu, w pionie i w poziomie. Co ważne płyta jest ocynkowana, dzięki czemu oprze się korozji.

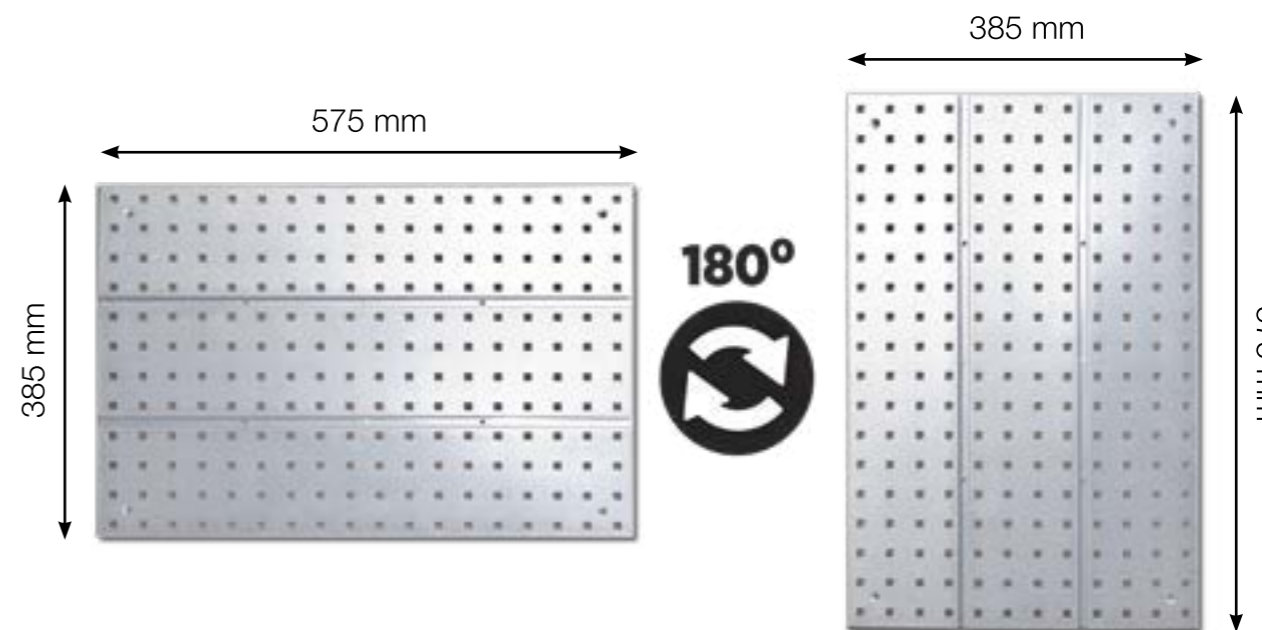

Whole range of accessories for hanging tools makes organising your workshop fun.

Różnorodność oferowanych w zestawie akcesoriów do zawieszania zapewnia łatwą organizację narzędzi.



Standardised size of tool hangers let you put away your power tools easily and always in easy reach of a hand.

Uniwersalne wymiary zawieszek pozwalają na wygodną organizację narzędzi ręcznych, jak również elektronarzędzi.



Screwdriver organiser has 13 holes of different sizes so you can keep your screwdrivers in one place and in total order.

Organizer na śrubokręty posiada aż 13 otworów w różnych rozmiarach, aby zapewnić miejsce dla każdego rodzaju i typu śrubokręta.

ACCESSORIES LIST

Lista dodatkowych akcesoriów

Accessory	Index	EAN	Set Dimensions		
6x	AKCPLTWPZ1HPM6PG001	5901238249023	155 x 30 x 220 mm	18	1728
6x	AKCPLTWPZ2HPD6PG001	5901238249030	155 x 30 x 220 mm	18	1728
6x	AKCPLTWPZ3HPDM6PG001	5901238249047	155 x 30 x 220 mm	18	1728
6x	AKCPLTWPZ4HPDD6PG001	5901238249054	155 x 30 x 220 mm	18	1728
6x	AKCPLTWPZ5UN6PG001	5901238249061	155 x 30 x 220 mm	18	1728
6x	AKCPLTWPZ6AK6PG001	5901238249078	155 x 30 x 220 mm	18	1728
6x	AKCPLTWPZ7UE6PG001	5901238249085	155 x 30 x 220 mm	18	1728
6x	AKCPLTWPZ8OS1PG001	5901238249092	155 x 30 x 280 mm	18	1728
6x	AKCPLTWPZ9WK2PG001	5901238249108	155 x 30 x 280 mm	18	1728

Tool Wall Panel Set Basic

Tool Wall Panel - zestaw podstawowy

Product info

informacje o produkcie

575 [L] x 385 [W] x 500 [H] mm

Colour	Index	EAN		
	Z249009PG001	5901238249009	56	4

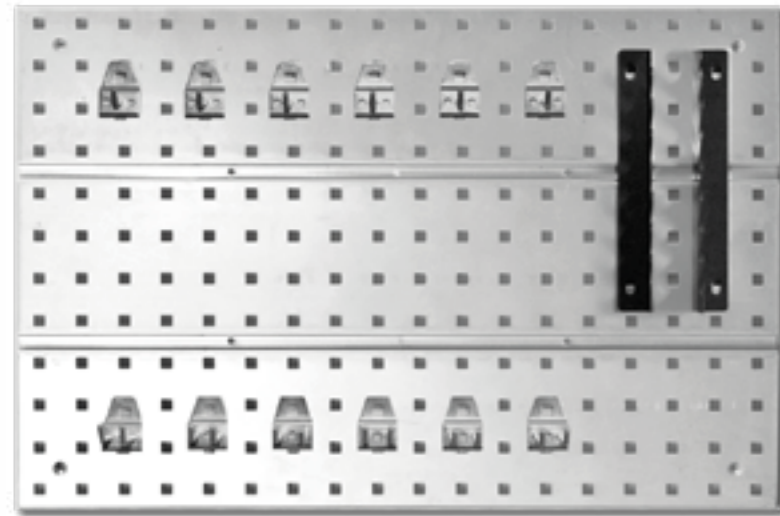

Set Includes

Zestaw zawiera



x1 Shelf for minor tools
Półka na śrubokręty

x2 Key holders
Wieszaki na klucze



x6 Small double hooks
Małe podwójne haki



x6 Large single hooks
Duże pojedyncze haki



Tool Wall Panel Set Premium

Tool Wall Panel - zestaw rozszerzony

Product info

informacje o produkcie

575 [L] x 385 [W] x 500 [H] mm

Colour	Index	EAN		
	Z249016PG001	5901238249016	56	4

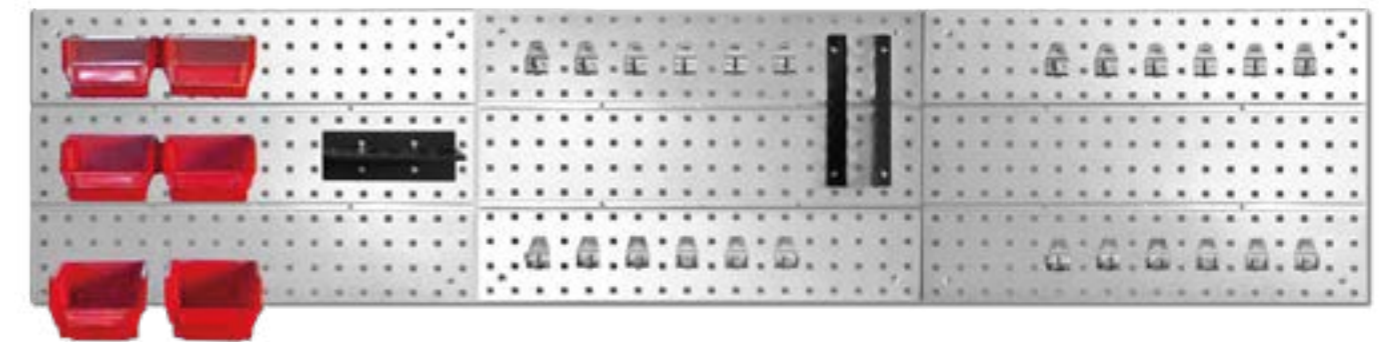

Set Includes

Zestaw zawiera



x1 Shelf for minor tools
Półka na śrubokręty



x2 Key holders
Wieszaki na klucze



x6 Small single hooks
Małe pojedyncze haki



x6 Small double hooks
Małe podwójne haki



x6 Large single hooks
Duże pojedyncze haki



x6 Large double hooks
Duże podwójne haki



x6 Ergobox adapters
Adepty do montażu ergoboxów



x2 Ergobox 1 red
Ergobox 1 czerwony



x2 Ergobox 1 plus red
Ergobox 1 plus czerwony



x2 Ergobox 2 red
Ergobox 2 czerwony

WORKSHOP ACCESORIES

Akcesoria warsztatowe

In this offer there are ideal solutions for home and professional workshop. Metal and plastic tool wall panels allow you to organize a space with tools, and in storage containers you can store various sizes of screws or washers. In smaller rooms slats can be used to hang storage containers.

W tej ofercie znajdują się rozwiązania idealne dla przydomowego jak i zawodowego warsztatu. Ścianki metalowe i plastikowe pozwalają zorganizować przestrzeń z narzędziami, a w pojemnikach magazynowych można przechować różnej wielkości śrubki czy nakładki. W mniejszych pomieszczeniach doskonale sprawdzą się listwy, na których można zawiesić pojemniki magazynowe.





Metal Fixing Wall 600

Metalowa płyta warsztatowa 600

Product info

informacje o produkcie

575 [L] x 3 [W] x 318,5 [H] mm

Colour	Index	EAN		
	PLYTAWARMETPG002	5901238242956	384	8

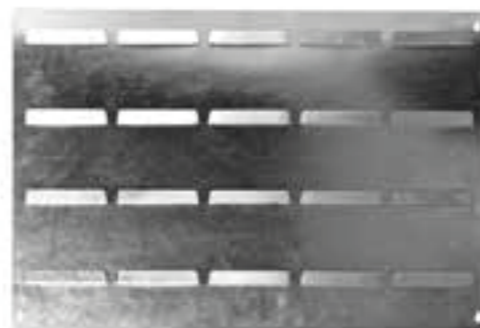



Fixing Wall 350

Płyta warsztatowa 350

Product info

informacje o produkcie

350 [L] x 18 [W] x 386 [H] mm

Colour	Index	EAN		
	PERFORERGPIOCZAPG001	5901238214298	600	20





Fixing Wall 350 accessories A11

Akcesoria płyty warsztatowej 350 A11

Product info

informacje o produkcie

Colour	Index	EAN		
	APW350A11CZEPG001	5901238215776	1728	18

Key holders x1
Uchwyty na klucze x1

Short hangers x5
Haczyki krótkie x5

Long hangers x5
Haczyki długie x5

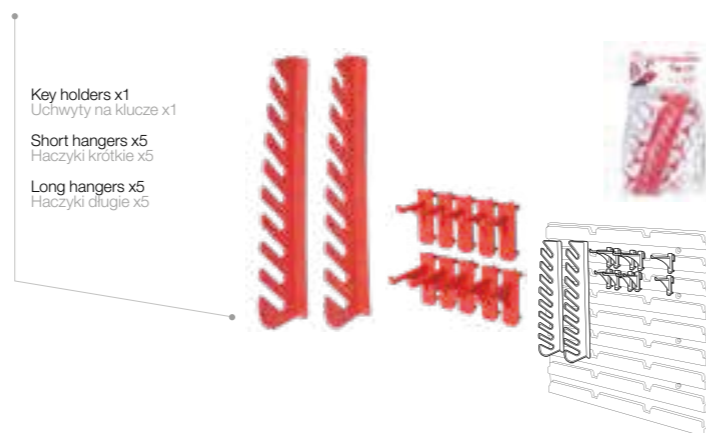



Fixing Wall 350 accessories B12

Akcesoria płyty warsztatowej 350 B12

Product info

informacje o produkcie

Colour	Index	EAN		
	APW350B12CZEPG001	5901238215042	1536	16

Shelf for drilling bits and sockets x1
Półka na wiertła i bity x1

Shelf for minor tools x1
Półka na drobne narzędzia x1

Holders x10
Uchwyty x10

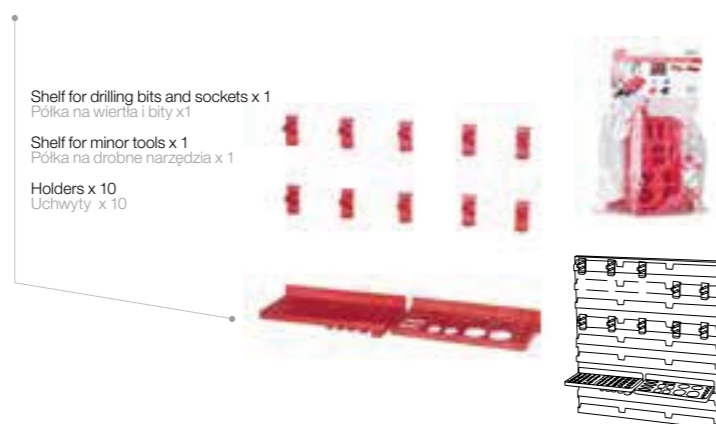

Plastic slat

Listwa plastikowa

Product info

informacje o produkcie

495[L] x 40 [W] mm

Colour	Index	EAN		
	LISTWAPLAPG001	5902455501444	9000	100



Metal slat

Listwa metalowa

Product info

informacje o produkcie

495[L] x 40 [W] mm

Colour	Index	EAN		
	LISTWAMETPG001	5907763087680	6300	70



Tool rack

Półka narzędziowa

Product info

informacje o produkcie

580[L] x 200 [W] mm

Colour	Index	EAN		
	POLKACZAPG001	5902455500966	320	20



Tool drawers

Szufiadki narzędziowe

Product info

informacje o produkcie

155[L] x 100 [W] x 225 [H] mm

Colour	Index	EAN		
	SZU10XCZAPG001	5902455501529	360	20

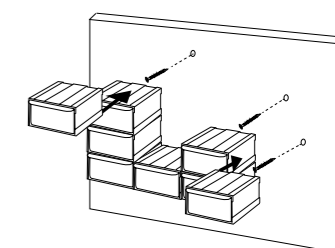



MULTIFUNCTIONAL BOXES

Pojemniki wielofunkcyjne



Ergo latch – durable, aesthetically appealing design. Thanks to its ergonomic manufacture, it makes it possible to fill the container to its capacity, at the same time reducing risk that accessories stored in the container will fall out.

Zapięcie Ergo - estetyczne, mocne. Dzięki ergonomii wykonania umożliwia maksymalne wypełnienie pojemnika, zmniejszając prawdopodobieństwo wypadnięcia gromadzonych w nim akcesoriów.



Handle- comfortable handle enhancing the convenience of transport.

Rączka - wygodna rączka zwiększa komfort użytkowania.



Multifunctional Box Small

Pojemnik Wielofunkcyjny Mały

Product info

informacje o produkcie

240 [L] x 115 [W] x 95 [H] mm

Colour	Index	EAN		
	PWFMALCZATPG001	5902455503035	672	28

Ergo latch
Zapięcie ergo
Handle
Rączka
Ergonomic packing
Ergonomiczne pakowanie





Multifunctional Box Medium

Pojemnik Wielofunkcyjny Średni

Product info

informacje o produkcie

285 [L] x 135 [W] x 115 [H] mm

Colour	Index	EAN		
	PWFSRECZATPG001	5902455502885	350	25

Ergo latch
Zapięcie ergo
Handle
Rączka
Ergonomic packing
Ergonomiczne pakowanie





Multifunctional Box Large

Pojemnik Wielofunkcyjny Duży

Product info

informacje o produkcie

330 [L] x 160 [W] x 140 [H] mm

Colour	Index	EAN		
	PWFDUZCZATPG001	5902455502908	260	26

Ergo latch
Zapięcie ergo
Handle
Rączka
Ergonomic packing
Ergonomiczne pakowanie



*tools not included/nie zawiera narzędzi

BUILDING

WYPOSAŻENIE BUDOWY

Products used when building a house, renovating flats and gardening. Different kind and sizes of building containers and buckets. Necessary for preparing all types of mortars, they are also great solution for storing loose materials.

Produkty wykorzystywane podczas budowy domu, remontu mieszkań oraz przy pracach ogrodowych. To różnej wielkości kasty budowlane i wiadra. Niezbędne do przygotowywania wszelkiego rodzaju zapraw, idealnie sprawdzą się również do przechowywania materiałów sypkich.



BUILDING BUCKETS

Wiadra budowlane

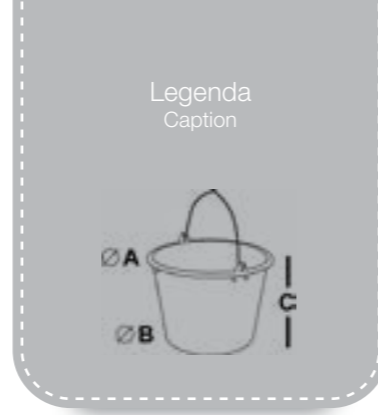

All types of construction buckets are made of highly flexible material resistant to mechanical damages. The buckets are especially well suited for the preparation of all sorts of dry and wet mortars. They come in a variety of sizes. These functional and comfortable buckets are indispensable for all types of construction and renovation works.

Produkty z szerokiej gamy wiader budowlanych, dzięki wysokiej elastyczności tworzywa, z którego zostały wykonane, są odporne na uszkodzenia mechaniczne. Idealne do rozrabiania różnego rodzaju zapraw suchych i mokrych. Dostępne w różnych rozmiarach. Są praktyczne i wygodne, niezbędne przy pracach budowlanych i remontowych.



Funnel – practical and convenient during renovations and construction works. It reduces the risk of water or mortar spillage while they are being poured from one container into another.

Lejek - jest praktyczny i wygodny podczas prac remontowych i budowlanych. Zmniejsza prawdopodobieństwo rozlania się wody, czy zaprawy podczas przelewania.



Strengthened bottom – the bottom of the bucket is supplied with additional ribs, which increases its durability against mechanical shock.

Wzmocnione dno - spód wiadra dodatkowo ożebrowany, co podnosi jego odporność na urazy mechaniczne.



Measure – practical convenience.

Miarka - praktyczne udogodnienie.



Plastichandle – better comfort of use.

Tulejka - plastikowy uchwyt podnosi komfort użytkowania.

*tools not included/nie zawiera narzędzi

Bucket Basic 5L with funnel

Wiadro Basic 5L z lejkiem

Product info

informacje o produkcie

230 [A] x 195 [B] x 170 [C] mm

Colour	Index	EAN	
	W5LEJBCZAPG001	5902455507408	1650

Measure
Miarka
Strengthened bottom
Wzmocnione dno
Funnel
Lejek



Bucket Basic 12L

Wiadro Basic 12L

Product info

informacje o produkcie

325 [A] x 235 [B] x 245 [C] mm

Colour	Index	EAN	
	W12BLEJBCZAPG001	5902455505725	954

Measure
Miarka
Strengthened bottom
Wzmocnione dno



Bucket Basic 12L with funnel

Wiadro Basic 12L z lejkiem

Product info

informacje o produkcie

314 [A] x 236 [B] x 245 [C] mm

Colour	Index	EAN	
	W12LEJBCZAPG001	5902455505879	936

Measure
Miarka
Strengthened bottom
Wzmocnione dno
Funnel
Lejek



Bucket Basic 16L

Wiadro Basic 16L

Product info

informacje o produkcji

330 [A] x 270 [B] x 285 [C] mm

Colour	Index	EAN	
	W16BLEJBCZAPG001	5907763087451	810

Measure
Miarka
Strengthened bottom
Wzmocnione dno



Bucket Basic 20L

Wiadro Basic 20L

Product info

informacje o produkcji

365 [A] x 264 [B] x 285 [C] mm

Colour	Index	EAN	
	W20BLEJBCZAPG001	5902455505893	648

Measure
Miarka
Strengthened bottom
Wzmocnione dno



Bucket Basic 16L with funnel

Wiadro Basic 16L z lejkiem

Product info

informacje o produkcji

360 [A] x 270 [B] x 285 [C] mm

Colour	Index	EAN	
	W16LEJBCZAPG001	5901238208624	540

Measure
Miarka
Strengthened bottom
Wzmocnione dno
Funnel
Lejek



Bucket Basic 20L with funnel

Wiadro Basic 20L z lejkiem

Product info

informacje o produkcji

365 [A] x 265 [B] x 285 [C] mm

Colour	Index	EAN	
	W20LEJBCZAPG001	5902455505886	660

Measure
Miarka
Strengthened bottom
Wzmocnione dno
Funnel
Lejek



BUILDING CONTAINERS

Kastry budowlane

Legenda
Caption



Construction containers are indispensable at every construction site. The containers are particularly well suited to prepare all sorts of cement and plaster mortars. All containers are produced of a heavy-duty material. They come in two shapes - rectangular and circular, in three sizes each.

Kastry budowlane stanowią niezastąpione narzędzie na każdej budowie. Idealne do przygotowywania różnego rodzaju zapraw cementowych i tynkarskich. Wytworzone z niezwykle wytrzymałego materiału. Dostępne w dwóch kształtach: prostokątnym i okrągłym, każdy w trzech rozmiarach.



Rectangular – ideal for hand and mechanical mixing of mortars. Made of plastic with increased resistance to shock and low temperatures. An item indispensable at every construction site.

Prostokątna - idealna do mieszania ręcznego i mechanicznego zaprawy murarskiej. Wykonana z tworzywa o podwyższonej odporności na uderzenia. Niezbędna rzecz na każdej budowie.



Round – resistant to mechanical damage, thanks to highly flexible materials used for its production. Suitable for mixing and transport of dry and wet mortars.

Okrągła - odporna na uszkodzenia mechaniczne, dzięki wykorzystaniu do produkcji wysokoelastycznych tworzyw. Przeznaczona do mieszania i transportu zapraw suchych i mokrych.



Rope handle – convenient solution allowing for the building container to be held by two people.

Sznurek - wygodne rozwiązanie umożliwiające chwycenie kastry przez dwie osoby.



Metal handle – facilitates the transport of building containers filled with heavy materials.

Uchwyt metalowy - ułatwia transportowanie kastry wypełnionej ciężkim materiałem.



Bowl for gypsum – indispensable for minor renovations.

Miska do gipsu - niezbędna przy drobnych pracach remontowych.



Bowl for gypsum

Miska do gipsu

Product info

informacje o produkcji

150 [A] x 53 [B] mm

Colour	Index	EAN		
	MGIPSCZAPG001	5902455505985	11440	65



Rectangular container 40L

Kastra prostokątna 40L

Product info

informacje o produkcji

795 [L] x 395 [W] x 185 [H] mm

Colour	Index	EAN		
	KP40NCZAPG001	5902455502717	396	3



Rectangular container 60L

Kastra prostokątna 60L

Product info

informacje o produkcji

795 [L] x 395 [W] x 295 [H] mm

Colour	Index	EAN		
	KP60NCZAPG001	5902455502724	345	3



Rectangular container 80L

Kastra prostokątna 80L

Product info

informacje o produkcji

785 [L] x 485 [W] x 300 [H] mm

Colour	Index	EAN		
	KP80CZAPG001	5907763082760	200	2



Round Building Container with handle 40L

Kastra budowlana okrągła 40L z uchwytem

Product info

informacje o produkcji

508 [A] x 288 [B] mm

Colour	Index	EAN		
	KO40UCZAPG001	5902455508535	110	2



Round Building Container 40L

Round Building Container 40L

Product info

informacje o produkcji

508 [A] x 288 [B] mm

Colour	Index	EAN		
	KO40CZAPG001	5902455506012	140	2



Round Building Container 65L

Round Building Container 65L

Product info

informacje o produkcji

594 [A] x 336 [B] mm

Colour	Index	EAN		
	KO65CZAPG001	5902455505503	108	2



Round Building Container with rope 40L

Kastra budowlana okrągła 40L ze sznurkiem

Product info

informacje o produkcji

508 [A] x 288 [B] mm

Colour	Index	EAN		
	KO40SZNCZAPG001	5902455507279	134	2



Round Building Container 90L

Round Building Container 90L

Product info

informacje o produkcji

651 [A] x 369 [B] mm

Colour	Index	EAN		
	KO90CZAPG001	5902455505510	95	2





Round Building Container with rope 65L

Kastra budowlana okrągła 65L ze sznurkiem

Product info

informacje o produkcji

594 [A] x 336 [B] mm

Colour	Index	EAN		
	KO65SZNCZAPG001	5902455507323	106	2



**WE CREATE
PLASTIC WONDERS**

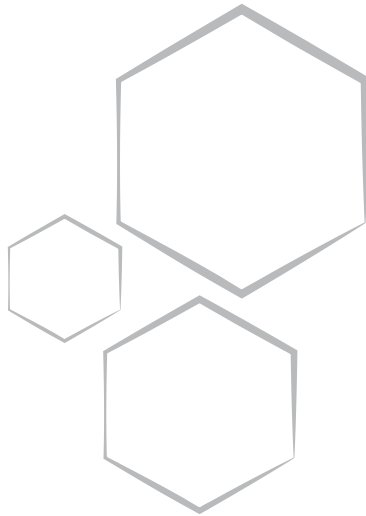



PATROL[®]
GROUP

**WE CREATE
PLASTIC WONDERS**

patrolgroup.com

